

EXHAUST TUBES

For all our latest catalogue updates and company info: www.tvh.com

EXHAUST TUBES

used for: **TCM**

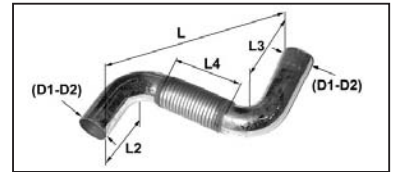

Number of bends AT-BO	Smallest outer dia. tube (mm) D1	Largest outer dia. tube (mm) D2	Dimension (mm) L	Dimension (mm) L2	Dimension (mm) L3	Dimension (mm) L4	REF
0	34	39	245				134TA6126
	35	38	179				108TA4458
	35	38	280				105TA7439
	38	49	305			210	134TA5806
	40	45	250				134TA6022
	43	46	340				124TA7249
1	35	38	165	80	95		105TA7352
	35	38	215	80	140		105TA7363
	35	39	150	50	100		139TA4253
	38	40	295	150	190		134TA5853
	38	41	290	170	195		105TA7440
	38	41	290	175	183		134TA5711

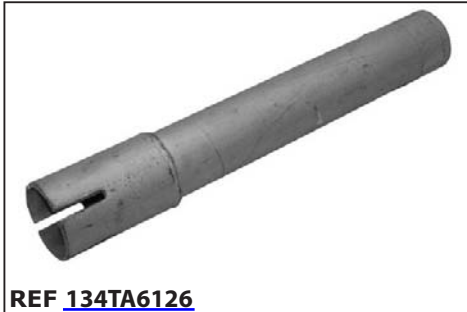

EXHAUST TUBES

For all our latest catalogue updates and company info: www.tvh.com



EXHAUST TUBES

used for: **TCM**

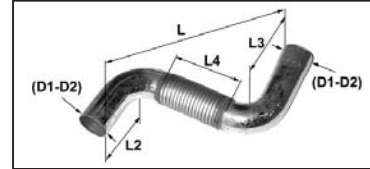

Number of bends	Smallest outer dia. tube (mm) D1	Largest outer dia. tube (mm) D2	Dimension (mm) L	Dimension (mm) L2	Dimension (mm) L3	Dimension (mm) L4	REF
1	38	41	370	190	270		105TA6970
	38	42	310	110	285		139TA4254
	51	54	135	60	85		139TA4255
	54	57	245	83	185		105TA7417
	54	57	380	160	310		124TA1066
	54	57	942	450	500		134TA5948
	57	57	420	170	325		118TA1525
	57	61	205	90	130		105TA6913
	57	61	510	100	500		134TA6328
	57	61	1260	50	1210		124TA1067
	57	62	335	125	310		105TA7284
2	32	45	124	40	45		110TA9624

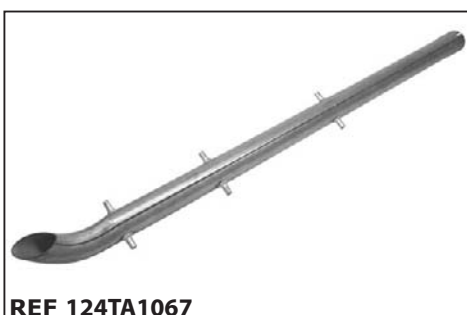

EXHAUST TUBES

For all our latest catalogue updates and company info: www.tvh.com

EXHAUST TUBES

used for: **TCM**

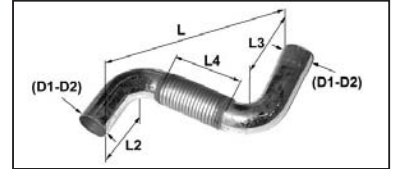

Number of bends AT-BO	Smallest outer dia. tube (mm) D1	Largest outer dia. tube (mm) D2	Dimension (mm) L	Dimension (mm) L2	Dimension (mm) L3	Dimension (mm) L4	REF
2	37	42	545	110	320		105TA6961
	38	38	270	45	135		134TA5807
	38	42	265	85	130		105TA6940
	38	42	405	130	245		124TA1064
	38	47	540	105	315		134TA5687
	38	47	545	105	335		139TA4256
	40	43	200	40	95		106TA5018
	40	45	535	85	130		134TA6034
	41	45	330	125	155		139TA4257
	42	42	540	100	290		108TA4503
	43	43	220	80	140		105TA7350
	43	43	275	75	105		139TA4258

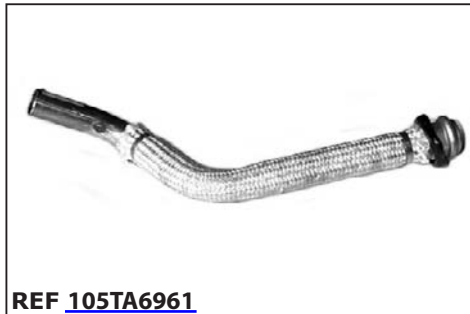

EXHAUST TUBES

For all our latest catalogue updates and company info: www.tvh.com



EXHAUST TUBES

used for: **TCM**

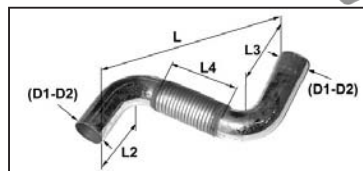

Number of bends AT-BO	Smallest outer dia. tube (mm) D1	Largest outer dia. tube (mm) D2	Dimension (mm) L	Dimension (mm) L2	Dimension (mm) L3	Dimension (mm) L4	REF
2	43	44	260	70	300	195	134TA6313
	45	45	265	75	75		139TA4259
	47	57	535	120	145		118TA1667
	49	49	470	125	235	130	134TA6066
	53	70	490	170	190		106TA5032
	54	56	765	170	255		134TA5809
	54	57	815	155	360		106TA5028
	54	70	475	155	165		111TA3677
	54	82	595	110	275		124TA7625
	57	57	290	80	120		123TA6720
	57	57	560	65	370		134TA6269
	57	61	430	130	240		105TA7295



REF [134TA6313](#)

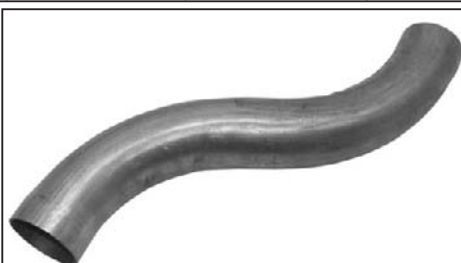

REF [139TA4259](#)



REF [118TA1667](#)



REF [134TA6066](#)



REF [106TA5032](#)



REF [134TA5809](#)



REF [106TA5028](#)



REF [111TA3677](#)



REF [124TA7625](#)



REF [123TA6720](#)



REF [134TA6269](#)



REF [105TA7295](#)

EXHAUST TUBES

For all our latest catalogue updates and company info: www.tvh.com

EXHAUST TUBES

used for: **TCM**

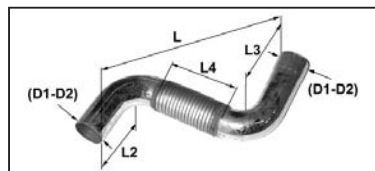

Number of bends	Smallest outer dia. tube (mm) D1	Largest outer dia. tube (mm) D2	Dimension (mm) L	Dimension (mm) L2	Dimension (mm) L3	Dimension (mm) L4	REF
2	57	61	480	154	320		118TA1526
	57	70	475	190	230		139TA4260
	58	60	220	50	105		134TA6320
	61	61	320	80	105	180	105TA6950
	61	61	490	50	150		105TA6906
	61	64	790	170	610		124TA4495
3	38	38	590	140	300		134TA5929
	38	42	465	125	125		124TA5145
	38	42	545	60	240		105TA7093
	42	42	555	140	320		105TA6959
	42	42	692	85	115		106TA6245
	42	43	655	50	130		105TA7422



EXHAUST TUBES

For all our latest catalogue updates and company info: www.tvh.com



EXHAUST TUBES

used for: **TCM**

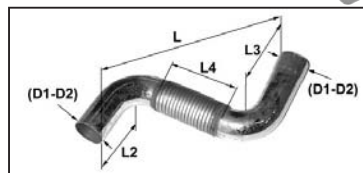

Number of bends AT-BO	Smallest outer dia. tube (mm) D1	Largest outer dia. tube (mm) D2	Dimension (mm) L	Dimension (mm) L2	Dimension (mm) L3	Dimension (mm) L4	REF
3	42	46	650	65	150		108TA4523
	42	47	530	110	120		106TA5029
	43	43	285	70	80		134TA5893
	43	43	325	45	80		105TA7346
	43	43	336	85	145		110TA8609
	43	46	560	95	185		105TA7109
	43	47	580	100	125		134TA6168
	44	44	410	30	45	255	134TA6112
	50	53	760	90	200	195	139TA4261
	51	51	640	135	155	125	134TA5976
	53	53	910	70	125	150	123TA6721
	54	70	880	120	195	150	134TA6149



EXHAUST TUBES

For all our latest catalogue updates and company info: www.tvh.com

EXHAUST TUBES

used for: **TCM**

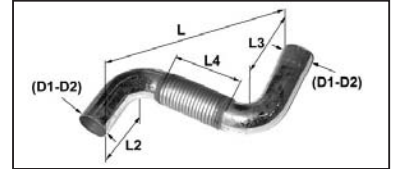

Number of bends AT-BO	Smallest outer dia. tube (mm) D1	Largest outer dia. tube (mm) D2	Dimension (mm) L	Dimension (mm) L2	Dimension (mm) L3	Dimension (mm) L4	REF
3	60	60	1040	90	265		134TA5708
	61	61	640	190	200	115	134TA6290
	76	76	1520	50	185		134TA6268
4	32	32	440	50	195		123TA6722
	37	38	587	40	108		110TA8601
	37	38	673	90	110		108TA4374
	38	38	743	80	155	160	139TA4262
	38	43	500	70	235		105TA7446
	41	46	555	175	220		139TA4263
	42	42	325	85	220		105TA6910
	42	42	490	85	125		110TA8602
	42	42	670	55	130		105TA7254



EXHAUST TUBES

For all our latest catalogue updates and company info: www.tvh.com



EXHAUST TUBES

used for: **TCM**

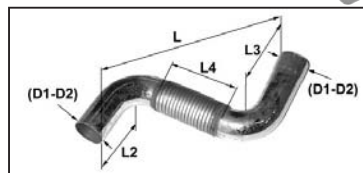

Number of bends	Smallest outer dia. tube (mm)	Largest outer dia. tube (mm)	Dimension (mm)	Dimension (mm)	Dimension (mm)	Dimension (mm)	REF
AT-BO	D1	D2	L	L2	L3	L4	
4	42	43	330	80	200		108TA4468
	42	43	355	105	205		118TA1617
	42	43	555	145	185		105TA7436
	42	43	570	140	200		105TA7253
	42	45	630	85	100		134TA6336
	43	49	800	88	105		123TA6723
	60	80	1455	115	360		134TA5820
5	38	38	545	85	105		105TA7040
	38	38	570	65	165		105TA6904
	38	38	770	55	142	185	134TA6363
	38	38	860	70	115		106TA5020
	38	42	610	70	90		105TA7330

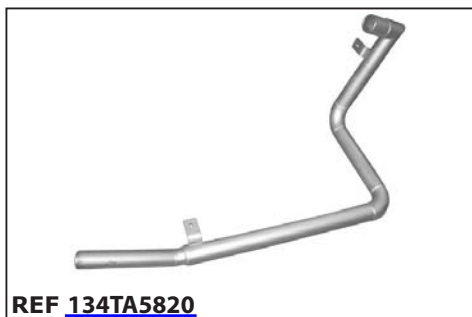

EXHAUST TUBES

For all our latest catalogue updates and company info: www.tvh.com

EXHAUST TUBES

used for: **TCM**

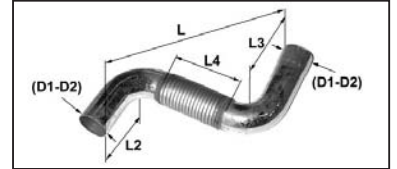

Number of bends AT-BO	Smallest outer dia. tube (mm) D1	Largest outer dia. tube (mm) D2	Dimension (mm) L	Dimension (mm) L2	Dimension (mm) L3	Dimension (mm) L4	REF
5	42	42	270	80	115		108TA4522
	42	42	645	50	80		105TA7263
	42	44	730	50	115		106TA5027
	43	43	710	55	150		105TA7183
	70	75	515	38	38		105TA7326
6	42	42	675	60	140		105TA7154
7	38	42	690	80	140		105TA7155

