

MUFFLERS

For all our latest catalogue updates and company info: www.tvh.com



MUFFLERS

used for: **TCM**

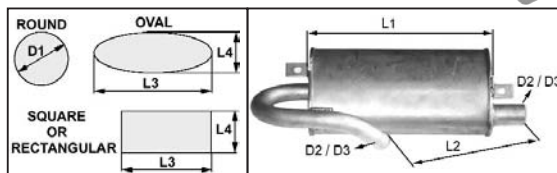

Type muffler	Length (mm) L1	Dimension (mm) L2	Body dimension (mm) dia. D1 or L3 x L4	Smallest outer dia. tube (mm) D2	Largest outer dia. tube (mm) D3	REF
Oval	350	265	144 X 92	35	42	105TA6662
Oval	373	445	240 X 130	44	46	108TA8871
Oval	380	150	207 X 135	42	49	139TA1654
Oval	380	200	250 X 135	42	47	134TA7819
Oval	380	345	250 X 140	43	46	123TA6069
Oval	380	630	206 X 126	38	42	134TA7885
Oval	380	645	210 X 130	38	42	134TA7886
Oval	380	753	246 X 138	38	41	105TA6661
Oval	380	785	245 X 140	38	41	134TA7820
Oval	382	790	244 X 130	38	41	110TA8583
Oval	390	470	210 X 110	38	42	134TA7621
Oval	390	630	210 X 110	37	42	139TA4637





MUFFLERS

For all our latest catalogue updates and company info: www.tvh.com

MUFFLERS

used for: **TCM**

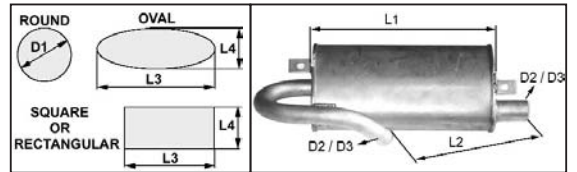

Type muffler	Length (mm) L1	Dimension (mm) L2	Body dimension (mm) dia. D1 or L3 x L4	Smallest outer dia. tube (mm) D2	Largest outer dia. tube (mm) D3	REF
Oval	394	510	200 X 101	33	46	118TA1246
Oval	395	100	210 X 120	38	47	104TA5991
Oval	398	880	230 X 105	38	47	134TA7678
Oval	400	190	210 X 110	42	46	134TA7907
Oval	400	210	205 X 125	46	39	124TA7569
Oval	400	230	200 X 115	39	48	104TA5887
Oval	400	310	208 X 111	42	46	105TA6772
Oval	400	310	210 X 120	39	47	134TA7572
Oval	400	430	206 X 112	38	46	105TA6658
Oval	400	512	204 X 104	35	45	108TA8870
Oval	400	515	205 X 110	35	45	134TA7703
Oval	400	550	210 X 110	38	42	134TA7590



MUFFLERS

For all our latest catalogue updates and company info: www.tvh.com



MUFFLERS

used for: **TCM**

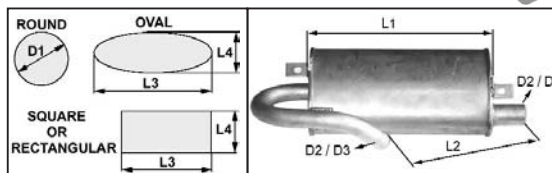

Type muffler	Length (mm) L1	Dimension (mm) L2	Body dimension (mm) dia. D1 or L3 x L4	Smallest outer dia. tube (mm) D2	Largest outer dia. tube (mm) D3	REF
Oval	400	620	210 X 105	38	45	134TA7777
Oval	400	650	205 X 110	38	42	134TA7611
Oval	600	700	257 X 198	63	65	134TA7974
Round	270	280	150	35	39	118TA1199
Round	300	210	165	41	42	105TA6685
Round	300	240	165	39	42	104TA5792
Round	300	290	160	38	42	123TA6070
Round	300	390	160	35	42	104TA5775
Round	300	540	170	38	43	105TA6757
Round	300	605	165	38	42	104TA5763
Round	300	680	161	37	43	108TA4362
Round	300	760	170	38	42	104TA5767





MUFFLERS

For all our latest catalogue updates and company info: www.tvh.com

MUFFLERS

used for: **TCM**

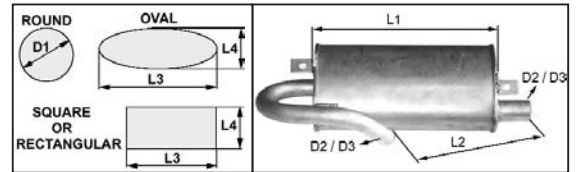

Type muffler	Length (mm) L1	Dimension (mm) L2	Body dimension (mm) dia. D1 or L3 x L4	Smallest outer dia. tube (mm) D2	Largest outer dia. tube (mm) D3	REF
Round	300	880	200	35	42	104TA5979
Round	300	890	190	34	47	124TA5195
Round	300	980	191	35	38	110TA8566
Round	300	1000	192	35	36	108TA4342
Round	304	760	190	39	41	108TA4329
Round	330	345	144	35	36	124TA5189
Round	335	610	210	38	42	134TA7824
Round	340	160	190	38	38	134TA7969
Round	340	187	109	34	36	105TA6831
Round	340	240	192	38	50	139TA1655
Round	340	280	110	34	34	105TA6801
Round	340	440	190	41	47	134TA7988



REF [104TA5979](#)



REF [124TA5195](#)



REF [110TA8566](#)



REF [108TA4342](#)



REF [108TA4329](#)



REF [124TA5189](#)



REF [134TA7824](#)



REF [134TA7969](#)



REF [105TA6831](#)



REF [139TA1655](#)



REF [105TA6801](#)



REF [134TA7988](#)

MUFFLERS

For all our latest catalogue updates and company info: www.tvh.com



MUFFLERS

used for: **TCM**

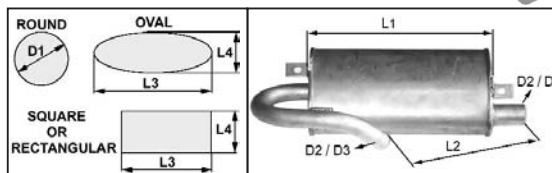

Type muffler	Length (mm) L1	Dimension (mm) L2	Body dimension (mm) dia. D1 or L3 x L4	Smallest outer dia. tube (mm) D2	Largest outer dia. tube (mm) D3	REF
Round	340	465	192	38	40	134TA8137
Round	340	500	190	38	47	134TA8077
Round	340	540	193	37	40	139TA1656
Round	340	560	200	38	39	134TA8046
Round	340	950	195	38	38	124TA2822
Round	340	995	200	35	47	123TA6071
Round	340	1060	196	38	47	118TA1313
Round	340	1070	200	38	38	123TA6072
Round	340	1100	193	38	38	124TA1987
Round	340	1120	200	38	38	139TA1657
Round	340	1170	200	38	38	134TA7814
Round	340	1200	200	38	38	134TA8018

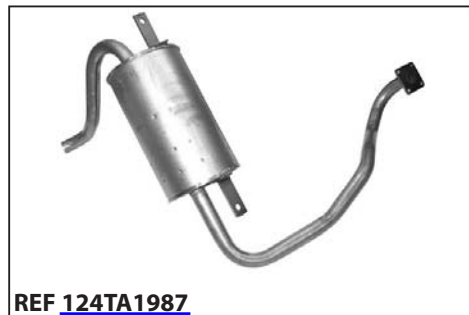



MUFFLERS

For all our latest catalogue updates and company info: www.tvh.com

MUFFLERS

used for: **TCM**

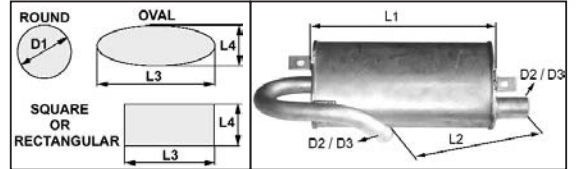

Type muffler	Length (mm) L1	Dimension (mm) L2	Body dimension (mm) dia. D1 or L3 x L4	Smallest outer dia. tube (mm) D2	Largest outer dia. tube (mm) D3	REF
Round	340	1200	200	38	48	134TA8015
Round	342	820	193	38	41	123TA6073
Round	342	865	192	37	47	134TA7822
Round	345	950	200	38	47	134TA7862
Round	365	230	160	43	47	139TA1658
Round	365	400	160	43	47	118TA1263
Round	376	190	160	43	47	105TA6739
Round	380	260	160	38	49	104TA5759
Round	390	230	165	44	48	104TA5914
Round	390	630	150	38	47	105TA6764
Round	395	535	200	47	52	139TA4638
Round	400	255	200	54	57	134TA8123

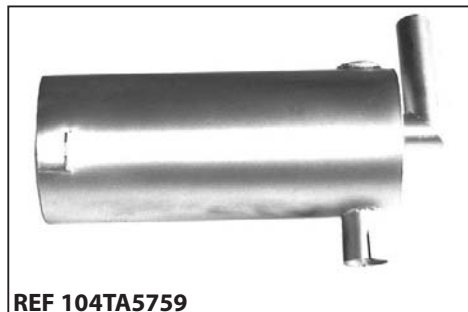

MUFFLERS

For all our latest catalogue updates and company info: www.tvh.com



MUFFLERS

used for: **TCM**

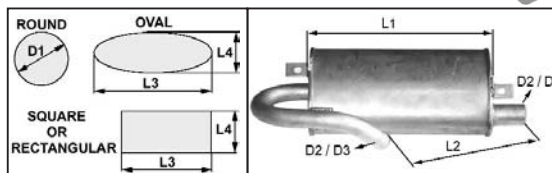

Type muffler	Length (mm) L1	Dimension (mm) L2	Body dimension (mm) dia. D1 or L3 x L4	Smallest outer dia. tube (mm) D2	Largest outer dia. tube (mm) D3	REF
Round	400	400	205	54	58	134TA7934
Round	400	505	159	42	47	105TA6849
Round	400	650	210	54	58	123TA6074
Round	445	290	125	40	44	124TA5190
Round	450	380	210	54	59	134TA7788
Round	450	1070	100	38	38	134TA7975
Round	450	1130	98	38	38	123TA6075
Round	450	1150	100	39	39	134TA8146
Round	450	1160	100	38	38	134TA7796
Round	455	1197	80	38	38	106TA7307
Round	495	960	214	50	54	134TA7950
Round	500	350	210	54	59	123TA9893





MUFFLERS

For all our latest catalogue updates and company info: www.tvh.com

MUFFLERS

used for: **TCM**

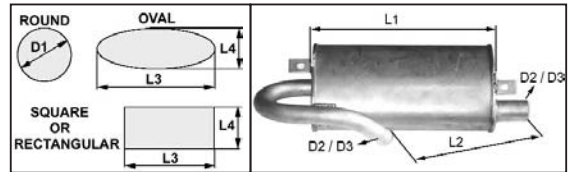

Type muffler	Length (mm) L1	Dimension (mm) L2	Body dimension (mm) dia. D1 or L3 x L4	Smallest outer dia. tube (mm) D2	Largest outer dia. tube (mm) D3	REF
Round	500	590	250	57	61	104TA5943
Round	500	610	210	61	57	105TA6837
Round	500	630	210	57	60	105TA6812
Round	500	630	210	57	60	104TA5733
Round	500	635	208	53	56	104TA5993
Round	500	790	212	50	53	134TA8089
Round	502	650	199	57	61	118TA1275
Round	550	655	95	50	50	139TA1659
Round	580	550	150	63	63	105TA6748
Round	600	650	250	61	64	139TA1660
Round	600	735	258	85	85	134TA7892
Round	645	615	240	60	60	124TA5192

