

Katalog



Sicherungen & Sicherungs- halter



TOTALSOURCE[®]

Look up
these parts via

myPS MyProductSearch

Part: 2 FUSES & FUSE HOLDERS

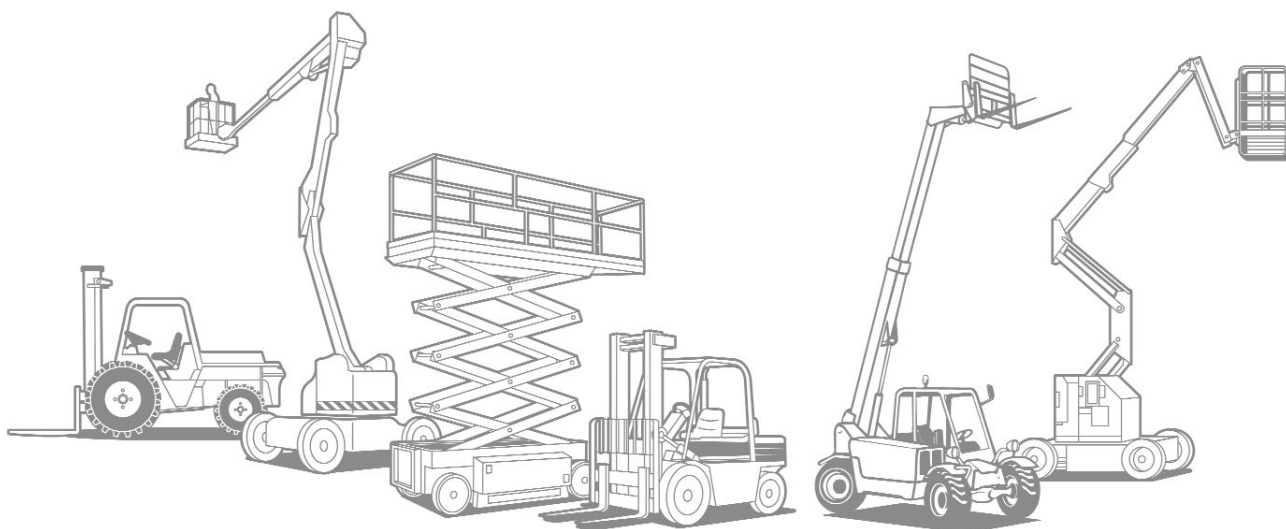



TECHNISCHE FICHE SMELTZEKERING

Groep
02-02-01-00



Gegevens klant

Type machine:

Prijsaanvraag

Serie nr. machine:

Bestelling

CODE: TY-ZE x PO-BG x D1 x D2 x D3 x L1 x B1 x H1 x C x L2 x B2 x H2 x B3 x H3 x B4 x H4 x B5 x U x I x AC/DC x DSN x TY-BE x DIN



TY-ZE Type zekering: **Zie Engelse technische fiche.**

- FS = strip zekering*
- FP = steek/automotive zekering*
- KF = mes zekering*
- PF = steek/buis zekering*
- SCF = schroef zekering*
- SMF = subminiatuur zekering*
- S = speciale zekering*

PO-BG..... Positie bevestigingsgaten (enkel bij type FS):

- GG = gesloten-gesloten*
- GO = gesloten-onder*
- GZ = gesloten-zijkant*
- OO = onder-onder*
- OZ = onder-zijkant*
- ZZ = zijkant-zijkant*

- D1 Diameter zekeringsbuis (zie figuren).
- D2 Diameter bevestigingsgat 1 (zie figuren).
- D3 Diameter bevestigingsgat 2, $D3 \leq D2$ (zie figuren).
- L1 Totale lengte (zie figuren).
- B1 Totale breedte (zie figuren).
- H1 Totale hoogte (zie figuren).
- C Centerafstand tussen bevestigingsgaten (zie figuren).
- L2 Lengte behuizing, indien aanwezig (zie figuren).



- B2..... Breedte behuizing, indien aanwezig (zie figuren).
 H2 Hoogte behuizing, indien aanwezig (zie figuren).
 B3..... Breedte fiche (zie figuren).
 H3 Hoogte fiche (zie figuren).
 B4..... Breedte mes (zie figuren).
 H4 Hoogte mes (zie figuren).
 B5..... Breedte bevestiging (zie figuren).
 U..... Spanning (V).
 I..... Stroom (A).
 AC/DC Wisselstroom (AC), gelijkstroom (DC).
 DSN..... Doormeltsnelheid:
 F = snel (Am, Gr)
 M = medium
 S = traag (Gg, gl)
 TY-BE Zelfdovend: JA/NEE.
 DIN DIN-normering (USA, JAP, ...).



FICHE TECHNIQUE FUSIBLE

Groupe
02-02-01-00

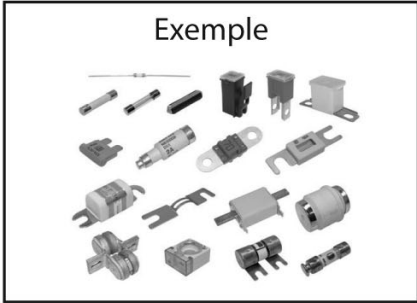

Données client

Type machine : Demande de prix
No. série machine : Commande

CODE : TY-ZE x PO-BG x D1 x D2 x D3 x L1 x B1 x H1 x C x L2 x B2 x H2 x B3 x H3 x B4 x H4 x B5 x U x I x AC/DC x DSN x TY-BE x DIN



TY-ZE Type de fusible : **Voir la fiche technique en anglais.**
FS = fusible stripe
FP = fusible bouchon/de automobile
KF = fusible couteaux
PF = fusible bouchon/cartouche
SCF = fusible visser
SMF = fusible sub-miniature
S = fusible spécial

PO-BG..... Position des trous de fixation (seulement pour type FS) :
GG = fermé-fermé
GO = fermé-dessous
GZ = fermé-côté
OO = dessous-dessous
OZ = dessous-côté
ZZ = côté-côté

D1 Diamètre du tube de fusible (voir figures).
D2 Diamètre trou de fixation 1 (voir figures).
D3 Diamètre trou de fixation 2, $D3 \leq D2$ (voir figures).
L1 Longueur totale (voir figures).
B1 Largeur totale (voir figures).
H1 Hauteur totale (voir figures).
C Entraxe entre les trous de fixation (voir figures).
L2 Longueur du corps, si présent (voir figures).



- B2..... Largeur du corps, si présent (voir figures).
- H2 Hauteur du corps, si présent (voir figures).
- B3..... Largeur de fiche (voir figures).
- H3 Hauteur de fiche (voir figures).
- B4..... Largeur du couteau (voir figures).
- H4 Hauteur du couteau (voir figures).
- B5..... Largeur de la fixation (voir figures).
- U..... Tension (V).
- I..... Ampérage (A).
- AC/DC Courant alternatif (AC), courant continu (DC).
- DSN..... Fusible a coupure :
 - F = rapide (Am, Gr)*
 - M = medium*
 - S = lente (Gg, gl)*
- TY-BE Avec extinction : OUI/NON (avec ou sans sable).
- DIN Norme DIN (USA, JAP, ...).



TECHNISCHES DATENBLATT SCHMELZSICHERUNG

Gruppe
02-02-01-00



Kundendaten

Maschinentyp:

Preisanfrage

Serien-Nr. Maschine:

Bestellung

CODE: TY-ZE x PO-BG x D1 x D2 x D3 x L1 x B1 x H1 x C x L2 x B2 x H2 x B3 x H3 x B4 x H4 x B5 x U x I x AC/DC x DSN x TY-BE x DIN



TY-ZE Typ Sicherung: **Siehe technische Datenblätter auf Englisch.**

- FS = Streifen sicherung*
- FP = Plug-in/Sicherung für Automobil*
- KF = Messersicherung*
- PF = Plug-in/Rohr Sicherung*
- SCF = Schraubsicherung*
- SMF = Kleinstsicherung*
- S = Spezielle Sicherung*

PO-BG..... Position Befestigungslöcher (nur bei Typ FS):

- GG = geschlossen-geschlossen*
- GO = geschlossen-unten*
- GZ = geschlossen-seitlich*
- OO = unten-unten*
- OZ = unten-seitlich*
- ZZ = seitlich-seitlich*

D1 Durchmesser Sicherungsröhre (siehe Abbildung).

D2 Durchmesser Sicherungsloch 1 (siehe Abbildung).

D3 Durchmesser Sicherungsloch 2, $D3 \leq D2$ (siehe Abbildung).

L1 Gesamtlänge (siehe Abbildung).

B1 Gesamtbreite (siehe Abbildung).

H1 Gesamthöhe (siehe Abbildung).

C Mittenabstand zwischen Befestigungslöchern (siehe Abbildung).

L2 Länge Gehäuse, falls vorhanden (siehe Abbildung).



- B2..... Breite Gehäuse, falls vorhanden (siehe Abbildung).
- H2 Höhe Gehäuse, falls vorhanden (siehe Abbildung).
- B3..... Breite Anschluss (siehe Abbildung).
- H3 Höhe Anschluss (siehe Abbildung).
- B4..... Breite Klinge (siehe Abbildung).
- H4 Höhe Klinge (siehe Abbildung).
- B5..... Breite Befestigung (siehe Abbildung).
- U..... Spannung (V).
- I..... Strom (A).
- AC/DC Wechselstrom (AC), Gleichstrom (DC).
- DSN..... Durchschmelzgeschwindigkeit:
 F = schnell (Am, Gr)
 M = medium
 S = langsam (Gg, gl)
- TY-BE Selbstlöschend: JA/NEIN.
- DIN DIN Normierung (USA, JAP, ...).



TECHNICAL SHEET

SAFETY FUSE

Group
02-02-01-00

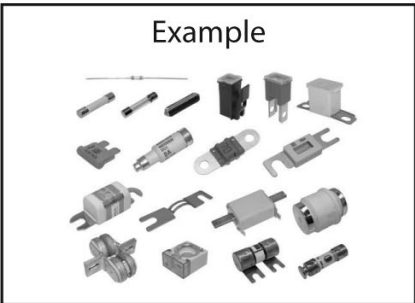

Customer details

Type machine:

Price inquiry

Serial n° machine:

Order

CODE: TY-ZE x PO-BG x D1 x D2 x D3 x L1 x B1 x H1 x C x L2 x B2 x H2 x B3 x H3 x B4 x H4 x B5 x U x I x AC/DC x DSN x TY-BE x DIN



TY-ZE Type of fuse:
FS = fuse strip
FP = plug-in/automotive fuse
KF = blade style fuse
PF = plug-in/tube fuse
SCF = screw type fuse
SMF = sub-miniature fuse
S = special fuse

PO-BG Position of the fixing holes (only for type FS):
GG = closed-closed
GO = closed-under
GZ = closed-side
OO = under-under
OZ = under-side
ZZ = side-side

D1 Diameter fuse tube (see drawings).
 D2 Diameter fixing hole 1 (see drawings).
 D3 Diameter fixing hole 2, $D3 \leq D2$ (see drawings).
 L1 Total length (see drawings).
 B1 Total width (see drawings).
 H1 Total height (see drawings).
 C Center distance between the fixing holes (see drawings).
 L2 Length of the housing, if present (see drawings).



- B2..... Width of the housing, if present (see drawings).
- H2 Height of the housing, if present (see drawings).
- B3..... Width of the terminal (see drawings).
- H3 Height of the terminal (see drawings).
- B4..... Width of the blade (see drawings).
- H4 Blade height (see drawings).
- B5..... Width of the connection (see drawings).
- U..... Voltage (V).
- I..... Current (A).
- AC/DC Alternating current (AC), direct current (DC).
- DSN..... Melt through speed:
 F = fast (Am, Gr)
 M = medium
 S = slow (Gg, gl)
- TY-BE Self-extinguishing: YES/NO.
- DIN DIN-standard (USA, JAP, ...).



TYPE OF SAFETY FUSE

Type FS

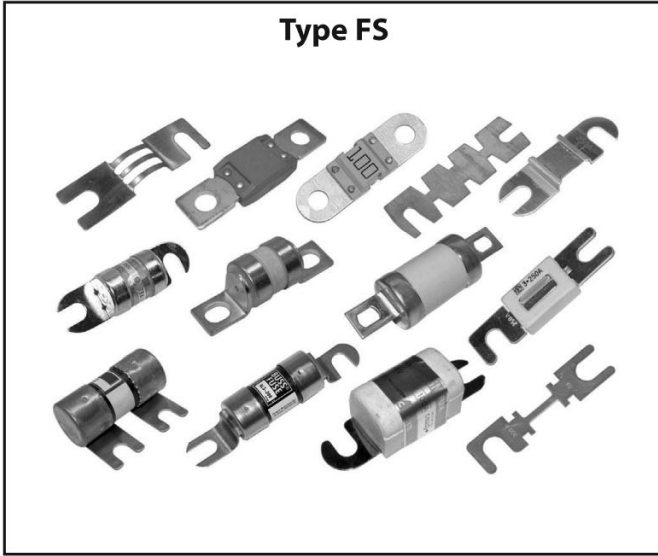

Type FP

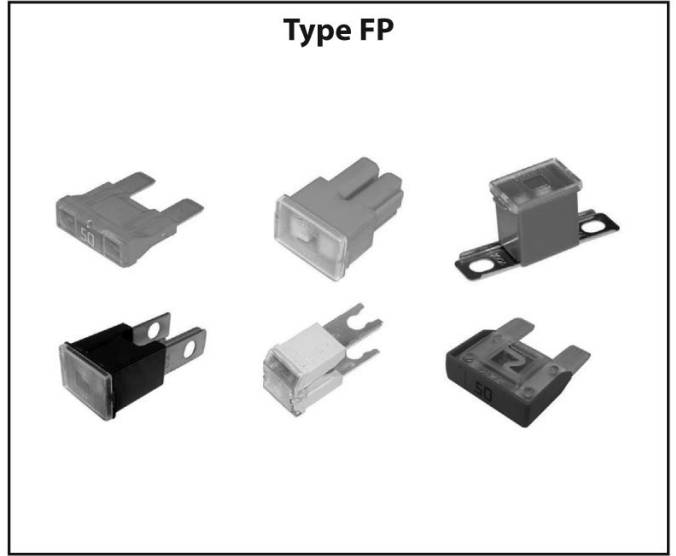

Type KF

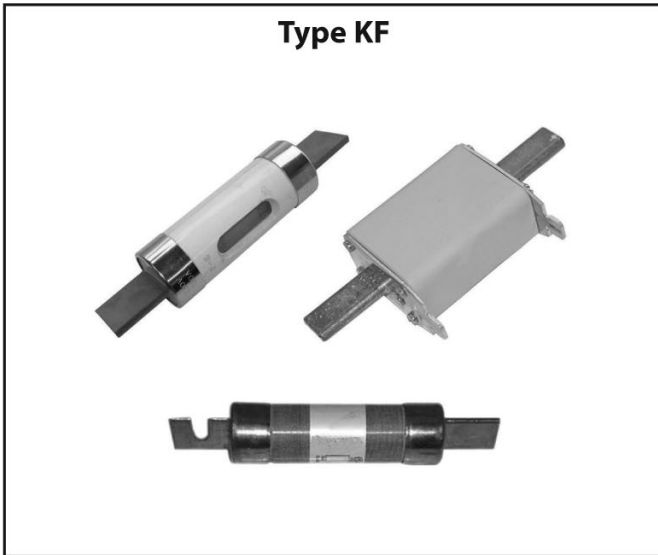

Type PF



Type SCF



Type SMF

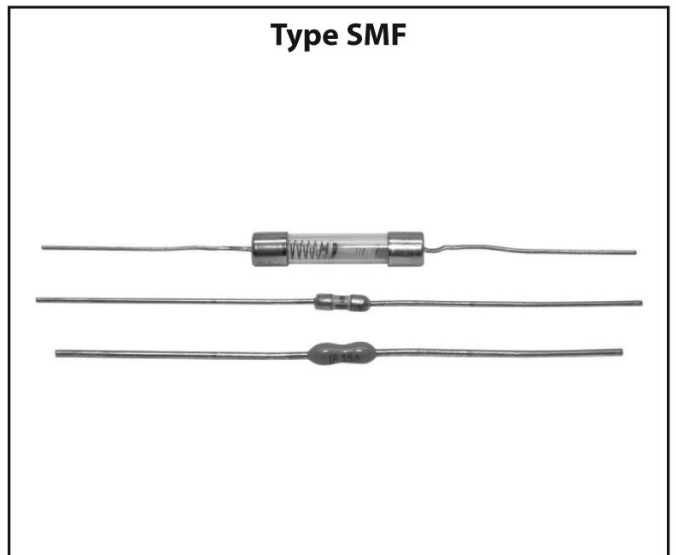

Special type



POSITION FIXING HOLES

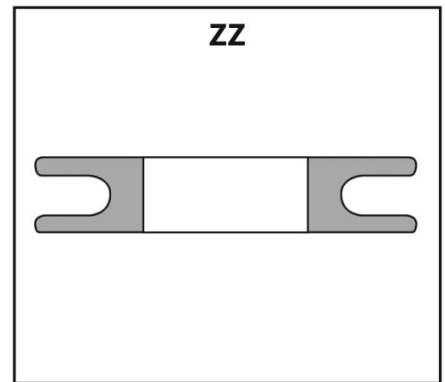
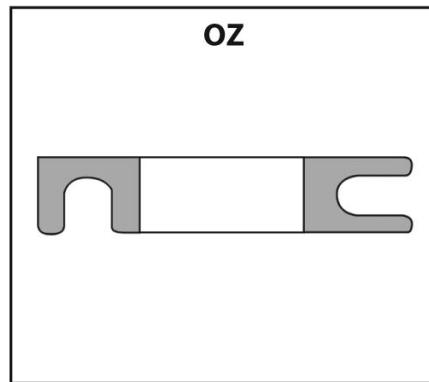
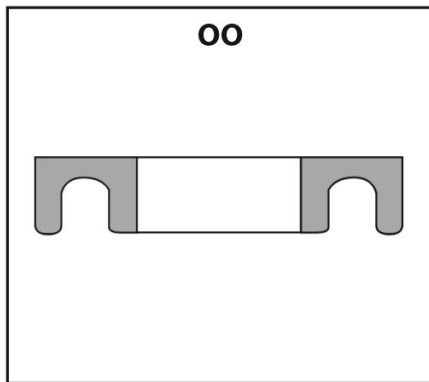
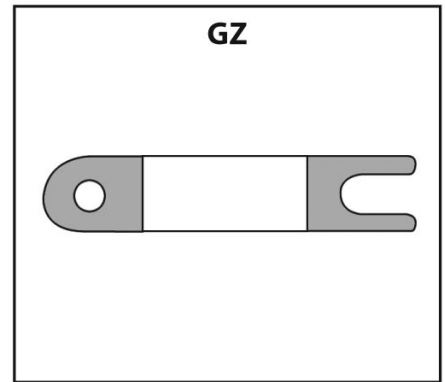
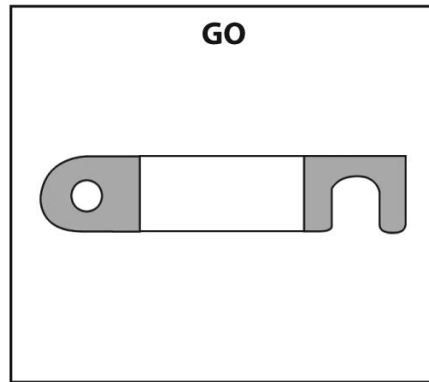
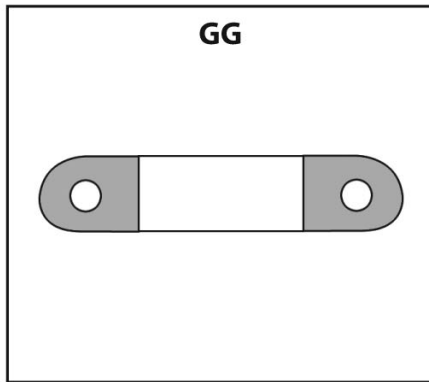

DIMENSIONS

Type FS

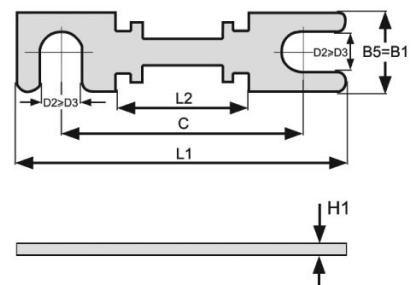
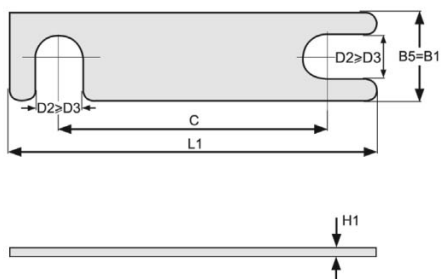
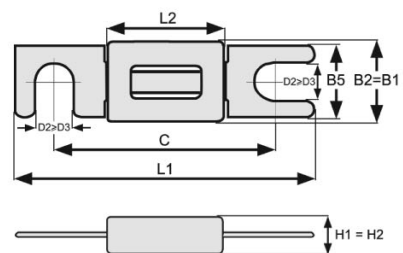
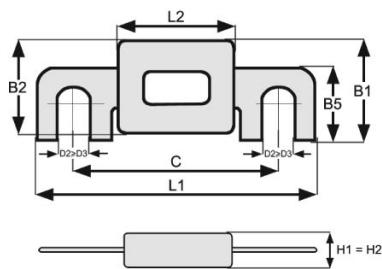



DIMENSIONS

Type FS

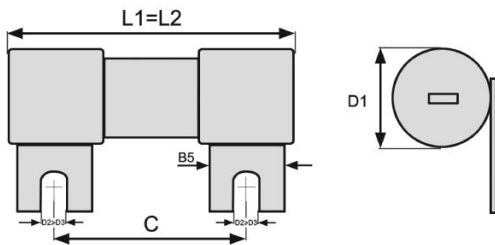
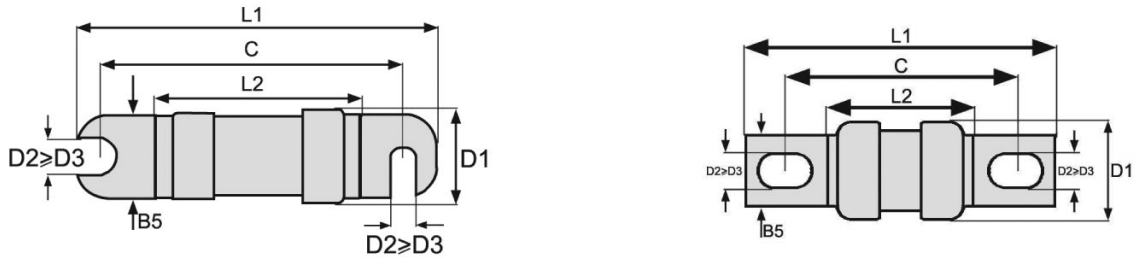

Type FP

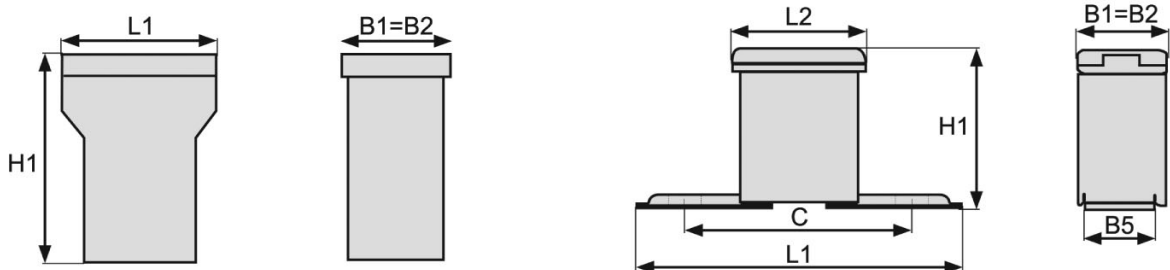
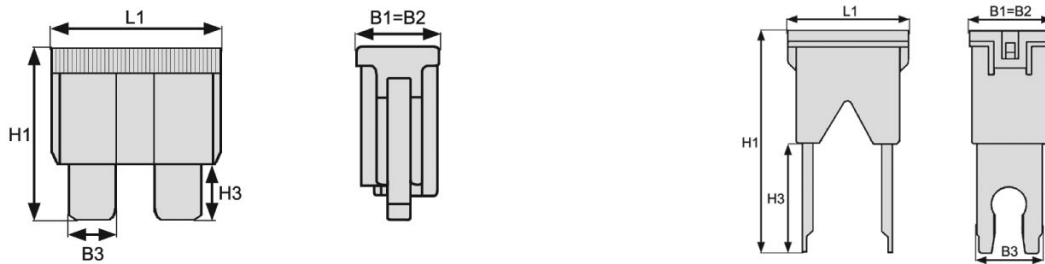



DIMENSIONS

Type KF

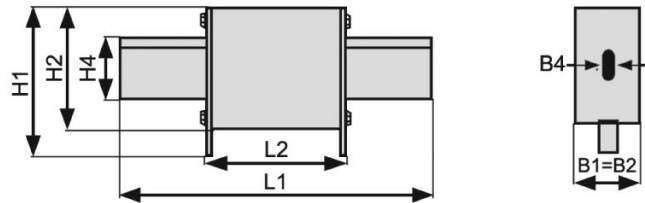
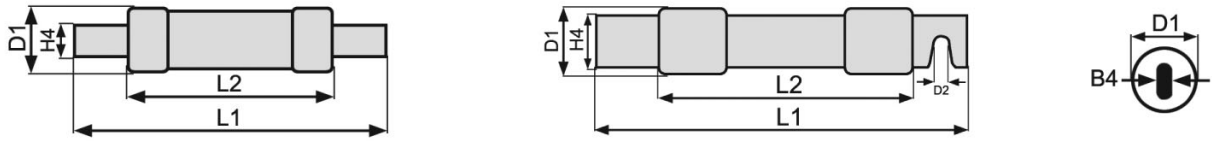

Type PF

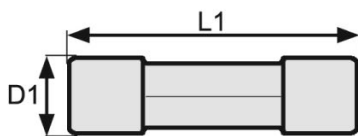

Type SCF

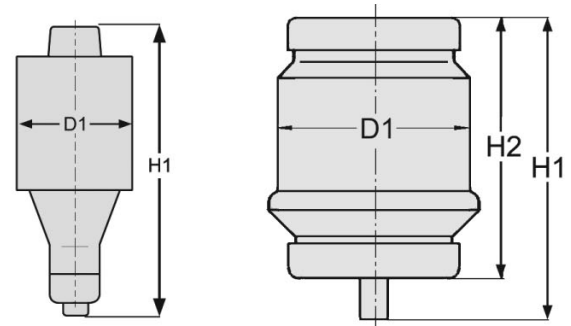

Type SMF

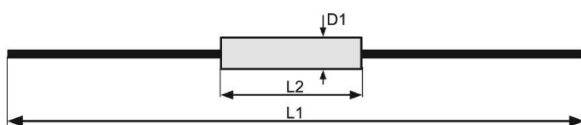



TECHNISCHE FICHE

AUTOMATISCHE ZEKERING

Groep
02-02-03-00

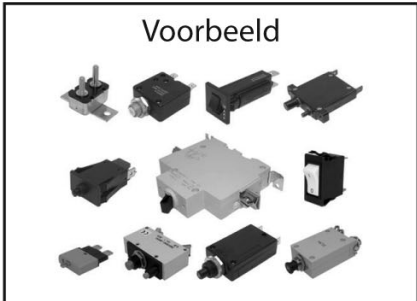

Gegevens klant

Type machine:

Prijsaanvraag

Serie nr. machine:

Bestelling

CODE: TY-ZE x L1 x B1 x D1 x H1 x L2 x B2 x D2 x H2 x D3 x D4 x AT-CO x TY-CO x B3 x H3 x H4 x H5 x BG x I1 x I2 x U-DC x U-AC x TA1 x TA2 x SO-ZE x KAP



TY-ZE Type automatische zekering (zie types): Zie Engelse technische fiche.

A = zekering met wipschakelaar

B = zekering met drukknop

C = zekering met 2 bedieningsknoppen

D = zekering met tuimelschakelaar

E = zekering zonder schakelaar

F = motorbeveiligingsschakelaar

L1..... Totale lengte (zie figuren).

B1..... Totale breedte (zie figuren).

D1 Grootste diameter (zie figuren).

H1 Totale hoogte (zie figuren). Voor type zekering B en C, knop niet ingedrukt.

L2..... Lengte behuizing (zie figuren).

B2..... Breedte behuizing (zie figuren).

D2 Diameter behuizing (zie figuren).

H2 Hoogte behuizing (zie figuren).

D3 Diameter drukknop (zie figuren).

D4 Diameter kleinste drukknop (zie figuren).

AT-CO..... Aantal aansluitingen.

TY-CO..... Type aansluiting (zie figuren).

B3..... Breedte fiche aansluiting (zie figuren).



- H3 Hoogte fiche aansluiting (zie figuren).
- H4 Hoogte schroefdraad aansluiting (zie figuren).
- H5 Hoogte kleinste schroefdraad aansluiting, indien aanwezig (zie figuren).
- BG Beugel: JA/NEE, voor type zekering E (zie figuur).
- I1 Stroom 1 (A).
- I2 Stroom 2 (A), indien aanwezig ($I1 > I2$).
- U-DC Spanning DC (V).
- U-AC Spanning AC (V).
- TA1 Draadsoort inbouw (zie figuren).
- TA2 Draadsoort aansluiting (grootste indien meerdere, zie figuren).
- SO-ZE Soort zekering:
M = magnetisch
T = thermisch
HM = hydromagnetisch
TM = thermisch + magnetisch
- KAP Beschermkap: JA/NEE, zie figuren.



FICHE TECHNIQUE FUSIBLE AUTOMATIQUE

Groupe
02-02-03-00

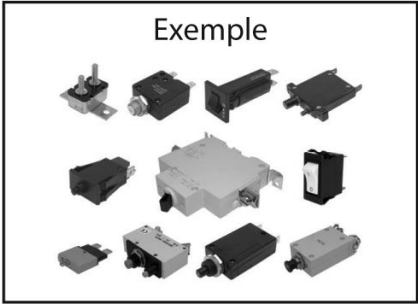

Données client

Type machine : Demande de prix
No. série machine : Commande

CODE : TY-ZE x L1 x B1 x D1 x H1 x L2 x B2 x D2 x H2 x D3 x D4 x AT-CO x TY-CO x B3 x H3 x H4 x H5 x BG x I1 x I2 x U-DC x U-AC x TA1 x TA2 x SO-ZE x KAP



- TY-ZE Type de fusible automatique (voir types) : **Voir la fiche technique en anglais.**
A = fusible avec interrupteur à bascule
B = fusible avec bouton poussoir
C = fusible avec 2 boutons de commande
D = fusible avec interrupteur à rocker
E = fusible sans interrupteur
F = disjoncteur moteur
- L1 Longueur totale (voir figures).
- B1 Largeur totale (voir figures).
- D1 Plus gros diamètre (voir figures).
- H1 Hauteur totale (voir figures). Pour type fusible B et C, bouton non enfoncé.
- L2 Longueur du corps (voir figures).
- B2 Largeur du corps (voir figures).
- D2 Diamètre du corps (voir figures).
- H2 Hauteur du corps (voir figures).
- D3 Diamètre du bouton poussoir (voir figures).
- D4 Diamètre du plus petit bouton poussoir (voir figures).
- AT-CO Nombre de connexions.
- TY-CO Type de connexion (voir figures).
- B3 Largeur de fiche de connexion (voir figures).



- H3 Hauteur de fiche de connexion (voir figures).
- H4 Hauteur du filetage de connexion (voir figure).
- H5 Hauteur du filetage de connexion le plus court, si présent (voir figure).
- BG Support : OUI/NON, pour les fusibles type E (voir figure).
- I1 Ampèreage 1 (A).
- I2 Ampèreage 2 (A), si présent ($I1 > I2$).
- U-DC Tension DC (V).
- U-AC Tension AC (V).
- TA1 Type de filetage côté encastrement (voir figures).
- TA2 Type de filetage de connexion (prendre le plus gros s'il y en a plusieurs, voir figures).
- SO-ZE Type de fusible :
M = magnétique
T = thermique
HM = hydro-magnétique
TM = thermique + magnéto
- KAP Protection : OUI/NON, voir figures.



TECHNISCHES DATENBLATT AUTOMATISCHE SICHERUNG

Gruppe
02-02-03-00

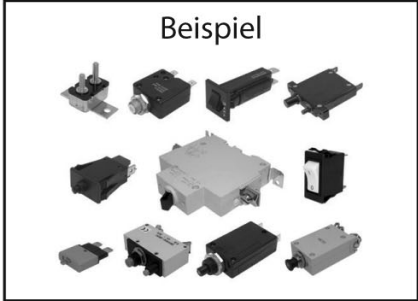

Kundendaten

Maschinentyp:

Preisanfrage

Serien-Nr. Maschine:

Bestellung

CODE: TY-ZE x L1 x B1 x D1 x H1 x L2 x B2 x D2 x H2 x D3 x D4 x AT-CO x TY-CO x B3 x H3 x H4 x H5 x BG x I1 x I2 x U-DC x U-AC x TA1 x TA2 x SO-ZE x KAP



- TY-ZE Typ automatische Sicherung (siehe Typen):
 - A = Sicherung mit Wippschalter
 - B = Sicherung mit Druckknopf
 - C = Sicherung mit 2 Bedienungsknöpfen
 - D = Sicherung mit Kippschalter
 - E = Sicherung ohne Schalter
 - F = Motorsicherheitsschalter

Siehe technische Datenblätter auf Englisch.

- L1 Gesamtlänge (siehe Figur).
- B1 Gesamt Breite (siehe Figur).
- D1 Grösste Durchmesser (siehe Figur).
- H1 Gesamthöhe (siehe Figur). Für Typen Sicherungen B und C., Knopf nicht eindrücken.
- L2 Länge Gehäuse (siehe Figur).
- B2 Breite Gehäuse (siehe Figur).
- D2 Durchmesser Gehäuse (siehe Figur).
- H2 Höhe Gehäuse (siehe Figur).
- D3 Durchmesser Druckknopf (siehe Figur).
- D4 Durchmesser kleinster Druckknopf (siehe Figur).
- AT-CO Anzahl Kontakte.
- TY-CO Kontakttyp (siehe Figur).
- B3 Breite Kontaktanschluss (siehe Figur).



- H3 Höhe Kontaktanschluss (siehe Figur).
- H4 Höhe Gewinde-anschluss (siehe Figur).
- H5 Höhe kleines Gewinde-anschluss, wenn anwesend (siehe Figur).
- BG Bügel: JA/NEIN, für Typ E Sicherungen (siehe Figur).
- I1 Strom 1 (A).
- I2 Strom 2 (A), wenn anwesend ($I1 > I2$).
- U-DC Spannung DC (V).
- U-AC Spannung AC (V).
- TA1 Einbaugewinde (siehe Figur).
- TA2 Anschlussgewinde (grösste wenn mehrere, siehe Figur).
- SO-ZE Sorte Sicherung:
M = magnetisch
T = thermisch
HM = hydro-magnetisch
TM = thermisch + magnetisch
- KAP Schutzkappe JA/NEIN, siehe Figur.



TECHNICAL SHEET AUTOMATIC FUSE

Group
02-02-03-00

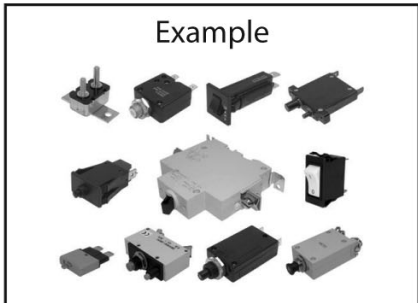

Customer details

Type machine:

Price inquiry

Serial n° machine:

Order

CODE: TY-ZE x L1 x B1 x D1 x H1 x L2 x B2 x D2 x H2 x D3 x D4 x AT-CO x TY-CO x B3 x H3 x H4 x H5 x BG x I1 x I2 x U-DC x U-AC x TA1 x TA2 x SO-ZE x KAP



TY-ZE Type of automatic fuse (see types):

A = fuse with toggle switch

B = fuse with push button

C = fuse with 2 operating buttons

D = fuse with rocker switch

E = fuse without switch

F = motor circuit breaker

L1..... Total length (see figures).

B1..... Total width (see figures).

D1 Largest diameter (see figures).

H1 Total height (see figures). For fuse type B and C, button not pressed.

L2..... Length of the housing (see figures).

B2..... Width of the housing (see figures).

D2 Diameter of the housing (see figures).

H2 Height of the housing (see figures).

D3 Diameter of the push button (see figures).

D4 Diameter smallest push button (see figures).

AT-CO..... Number of connections.

TY-CO..... Type of connection (see figures).

B3..... Width connection tip (see figures).

H3 Height connection tip (see figures).



- H4 Height connection thread (see figures).
- H5 Height smallest connection thread, if present (see figures).
- BG Bracket: YES/NO, for fuse type E (see figure).
- I1 Current 1 (A).
- I2 Current 2 (A), if present ($I1 > I2$).
- U-DC..... Voltage DC (V).
- U-AC..... Voltage AC (V).
- TA1 Built-in thread type (see figures).
- TA2 Thread type connection (largest if multiple, see figures).
- SO-ZE Type of fuse:
 M = magnetic
 T = thermal
 HM = hydromagnetic
 TM = thermal + magnetic
- KAP Cover: YES/NO, see figures.



TYPES

Type A



Type B



Type C



Type D



Type E



Type F





DIMENSIONS

Type A

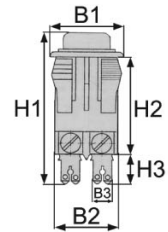
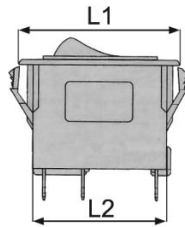

Type B

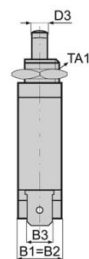
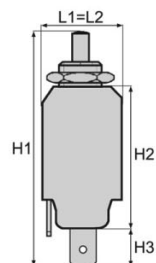
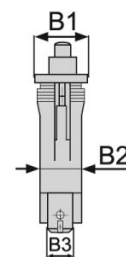
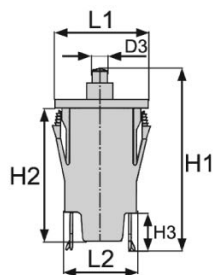
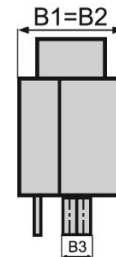
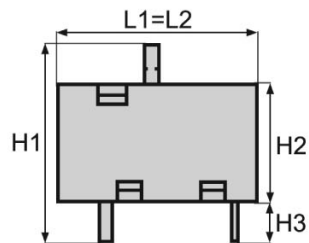
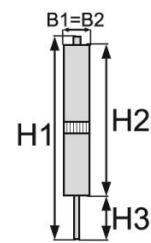
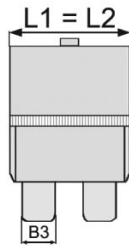



DIMENSIONS

Type B

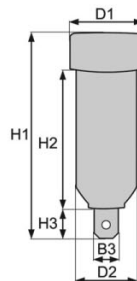
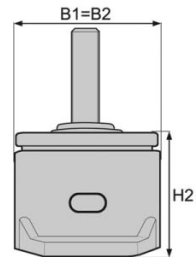
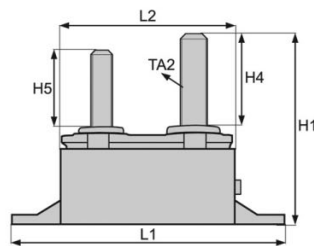
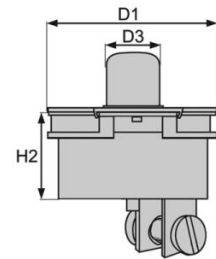
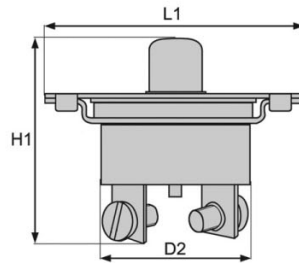
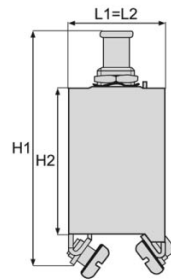
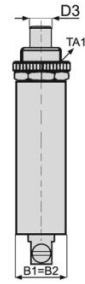
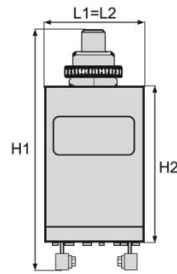



DIMENSIONS

Type C

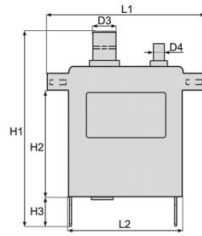

Type D

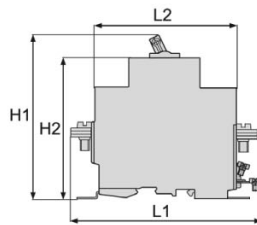

Type E

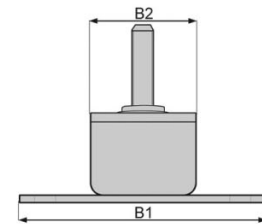
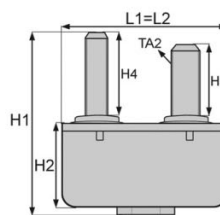
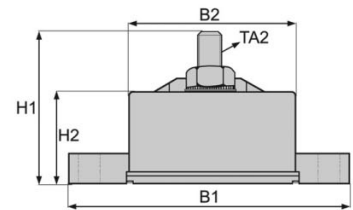
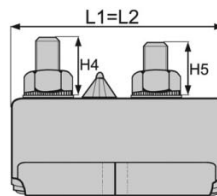

Type F

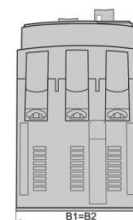
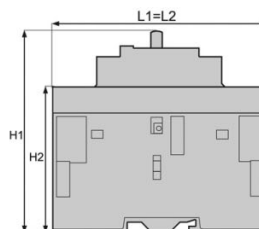



TYPE OF CONNECTION

Type A



Type B



Type C

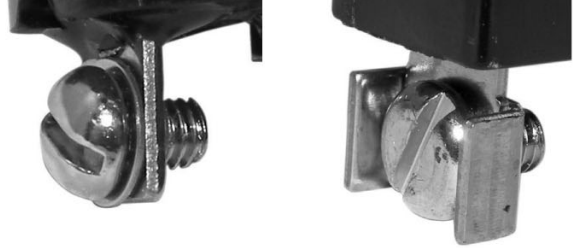

Type D



Type E

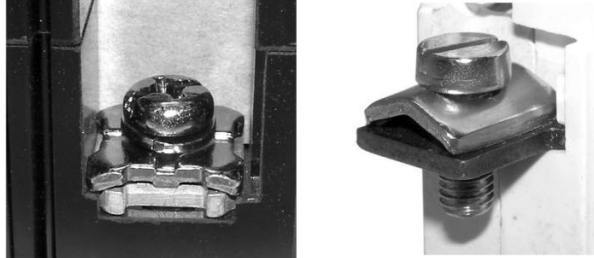

Type F



Kap

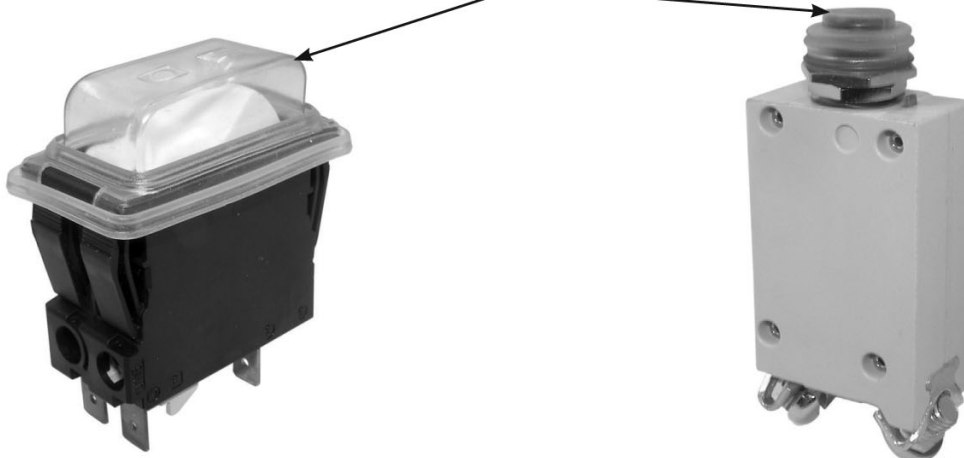

1. FUSE STRIPS

For all our latest catalogue updates and company info: www.tvh.com



FUSES



AMP = Current (A)
SPEED IND. = Speed indication (SLOW, MEDIUM, FAST)
EX. AGENT = Extinguishing agent (sand)



STANDARD: DIN72581/2 / SLOW



1 REF =
1 box of 100 pieces!

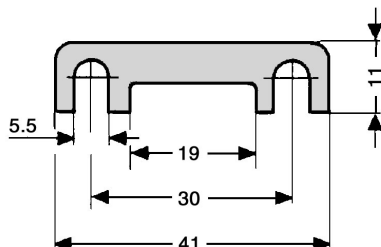

REF/100 pcs.	AMP
127TA1973	25
127TA1974	30
127TA1975	40
127TA1976	50
127TA1977	60
127TA1978	70
127TA1979	80
127TA1980	100
127TA1981	120
127TA1982	125
127TA1983	150
127TA1985	250

STANDARD: DIN43560/1 / FAST



1 REF =
1 box of 50 pieces!

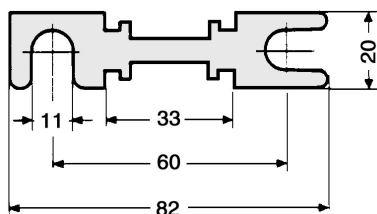
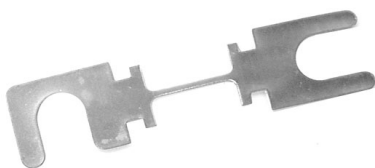

REF/50 pcs.	AMP
140TA8466	25
127TA1986	35
127TA1987	40
127TA1988	50
127TA1989	63
127TA1990	80
127TA1991	100
127TA1992	125
127TA1993	130
127TA1994	135
127TA1995	150
127TA1996	160
127TA1997	175
127TA1998	200
127TA1999	225
127TA2000	250
127TA2001	275
127TA2002	300
127TA2003	325
127TA2004	355
127TA2005	400
127TA2006	425
127TA2007	500

STANDARD: DIN43560/1 / FAST



1 REF =
1 box of 50 pieces!

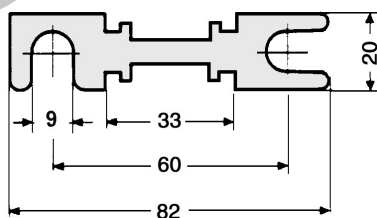
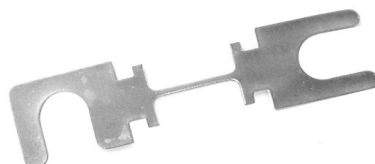

REF/50 pcs.	AMP
129TA7695	35
129TA7696	50
129TA7697	63
129TA7698	80
129TA7699	100
129TA7700	125
129TA7701	130
129TA7702	160
129TA7703	200
129TA7704	250

1. FUSE STRIPS

For all our latest catalogue updates and company info: www.tvh.com

FUSES

STANDARD: DIN72581/2 / SLOW



1 REF =
1 box of 50 pieces !

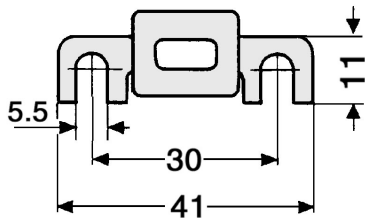
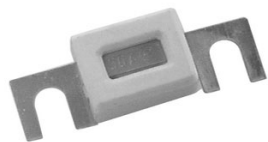

REF/50 pcs.	AMP
127TA2008	30
127TA2009	40
127TA2010	50
127TA2011	60
127TA2012	70
127TA2013	80
127TA2014	100
127TA2015	120
127TA2016	125
127TA2017	150

STANDARD: DIN43560/1 / FAST



1 REF =
1 box of 50 pieces !

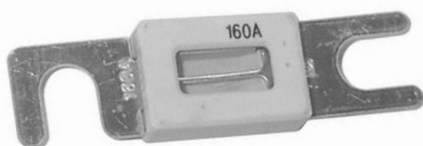
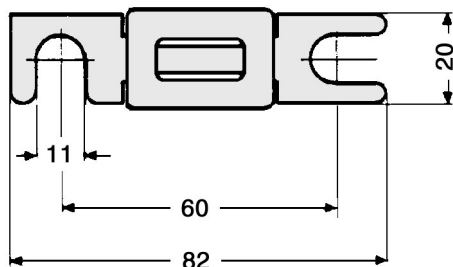

REF/50 pcs.	AMP
140TA8467	20
127TA2018	35
127TA2019	40
127TA2020	50
127TA2021	63
127TA2022	80
127TA2023	100
127TA2024	125
129TA7705	130
127TA2025	135
127TA2026	150
127TA2027	160
127TA2028	175
127TA2029	200
127TA2030	225
127TA2031	250
127TA2032	275
127TA2033	300
127TA2034	325
127TA2035	355
127TA2036	400
127TA2037	425
127TA2038	500

STANDARD: DIN43560/1 / FAST



1 REF =
1 box of 50 pieces !

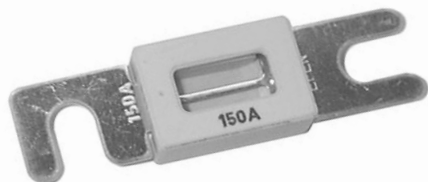
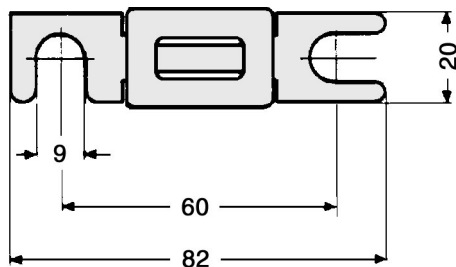

REF/50 pcs.	AMP
127TA2052	35
127TA2053	50
127TA2054	63
127TA2055	80
127TA2056	100
127TA2057	125
127TA2058	150
127TA2059	160
127TA2060	175
127TA2061	200
127TA2062	225
127TA2063	250
127TA2064	325
127TA2065	355
127TA2066	425
127TA2067	500

AMP = Current (A) • SPEED IND. = Speed indication (SLOW, MEDIUM, FAST) • EX. AGENT = Extinguishing agent (sand)

1. FUSE STRIPS



For all our latest catalogue updates and company info: www.tvh.com

FUSES

STANDARD: SPECIAL

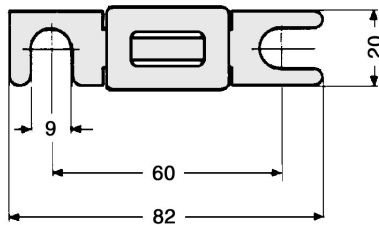
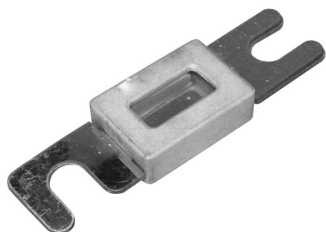

REF/pc.	AMP
140TA8468	3 x 250 (750)

STANDARD: SPECIAL

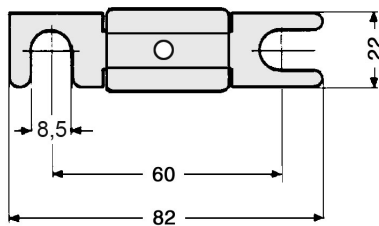

REF/pc.	AMP
140TA8469	275

STANDARD: SPECIAL

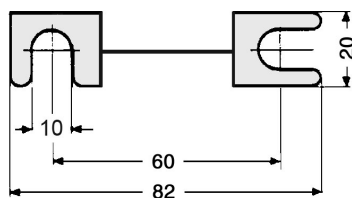
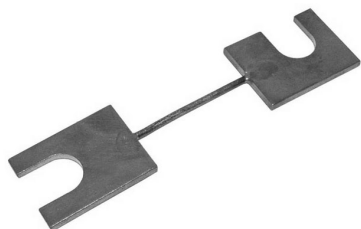

REF/pc.	AMP
140TA8470	400

STANDARD: SPECIAL

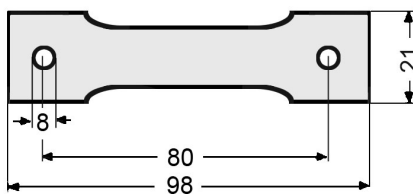

REF/pc.	AMP
140TA8471	150

STANDARD: LKN

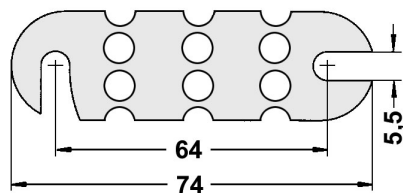

REF/pc.	AMP
106TA5057	70
106TA5058	80

STANDARD: LKN

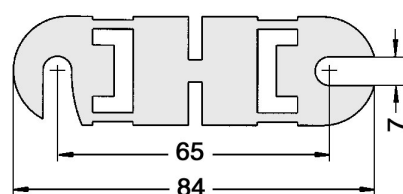
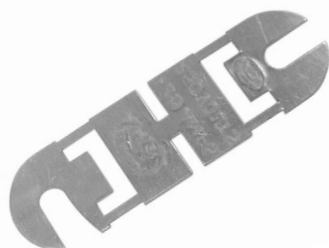

REF/pc.	AMP
103TA2998	125
103TA2999	200
126TA6232	250
103TA3000	300
103TA3001	350
103TA3002	600

AMP = Current (A) • SPEED IND. = Speed indication (SLOW, MEDIUM, FAST) • EX. AGENT = Extinguishing agent (sand)

1. FUSE STRIPS

For all our latest catalogue updates and company info: www.tvh.com

FUSES

STANDARD: CNN/ANN / FAST

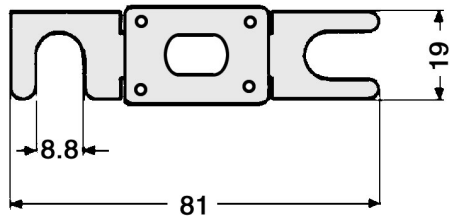

REF/pc.	AMP
106TA7087	35
106TA5045	40
106TA5046	50
106TA5047	60
106TA5048	80
106TA6928	100
106TA7088	125
106TA6929	150
106TA7089	175
106TA6927	200
106TA7090	225
106TA5049	250
106TA7091	275
106TA5050	300
106TA7092	325
106TA7093	350
106TA5051	400
106TA5052	500
106TA5053	600
106TA5055	700
106TA5056	800

STANDARD: CNL/ANL / SLOW

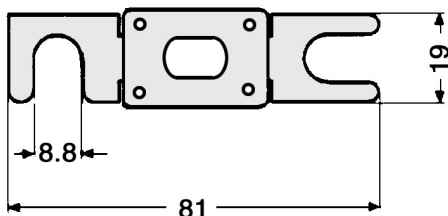

REF/pc.	AMP
106TA7084	35
106TA7085	40
106TA6938	50
106TA5036	60
106TA5037	80
106TA6937	100
106TA6936	125
106TA6935	130
106TA6931	150
106TA7086	175
106TA5039	200
106TA6934	225
106TA5040	250
106TA6933	275
106TA6930	300
106TA5041	325
106TA6932	350
106TA5042	400
106TA5043	500
106TA4977	600
106TA5044	675

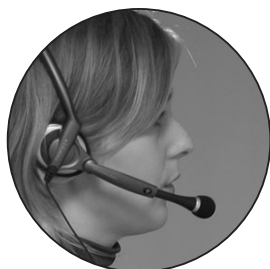

Look up
these parts via



AMP = Current (A) • SPEED IND. = Speed indication (SLOW, MEDIUM, FAST) • EX. AGENT = Extinguishing agent (sand)

1. FUSE STRIPS



For all our latest catalogue updates and company info: www.tvh.com

FUSES

STANDARD: BF1



1 REF =
1 box of 10 pieces!

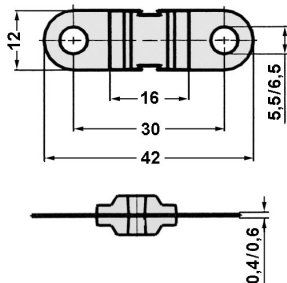

REF/10 pcs.	AMP
127TA2068	30
127TA2069	40
127TA2070	50
127TA2071	60
127TA2072	70
127TA2073	80
127TA2074	100
127TA2075	125
127TA2076	150
127TA2077	200

STANDARD: MEGA/BF2



1 REF =
1 box of 10 pieces!

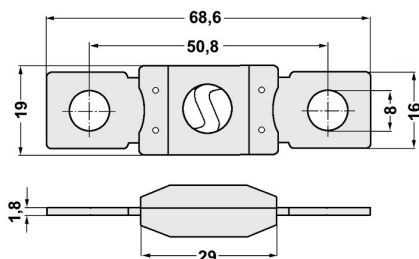

REF/10 pcs.	AMP
127TA2078	80
127TA2079	100
127TA2080	125
127TA2081	150
127TA2082	175
127TA2083	200
127TA2084	225
127TA2085	250
127TA2086	300
127TA2087	400
127TA2088	500

Look up
these parts via



AMP = Current (A) • SPEED IND. = Speed indication (SLOW, MEDIUM, FAST) • EX. AGENT = Extinguishing agent (sand)

1. FUSE STRIPS

For all our latest catalogue updates and company info: www.tvh.com

FUSES

STANDARD: FIAT / FAST

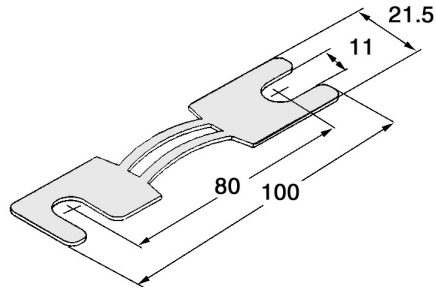

REF/pc.	AMP
103TA2964	75
103TA2965	100

STANDARD: FIAT / FAST

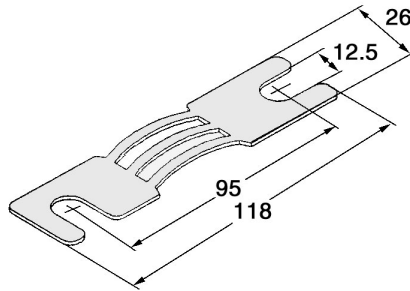

REF/pc.	AMP
119TA8940	100
103TA2966	150
103TA2967	200
140TA8472	250
140TA8473	300
140TA8474	350
123TA8295	400

STANDARD: FIAT / FAST

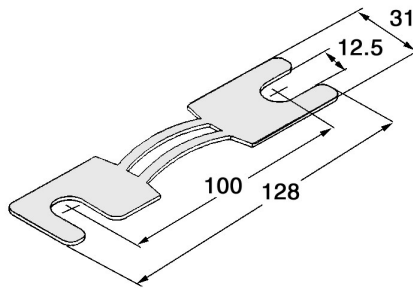
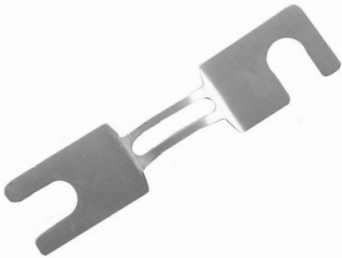

REF/pc.	AMP
103TA2962	250
103TA2963	300

STANDARD: FIAT / FAST

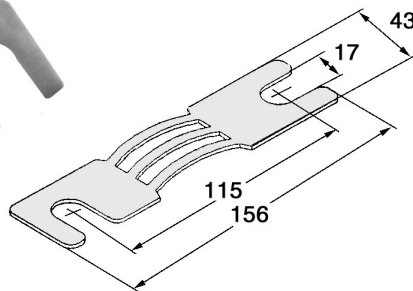

REF/pc.	AMP
140TA8475	350
103TA3019	400

AMP = Current (A) • SPEED IND. = Speed indication (SLOW, MEDIUM, FAST) • EX. AGENT = Extinguishing agent (sand)

1. FUSE STRIPS



For all our latest catalogue updates and company info: www.tvh.com

FUSES

STANDARD: JAPANESE

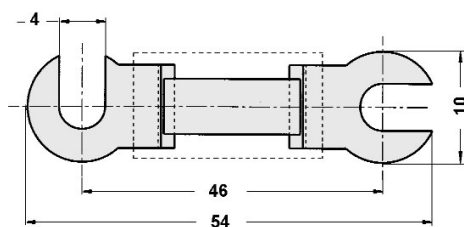

REF/pc.	AMP
127TA2267	5

STANDARD: JAPANESE

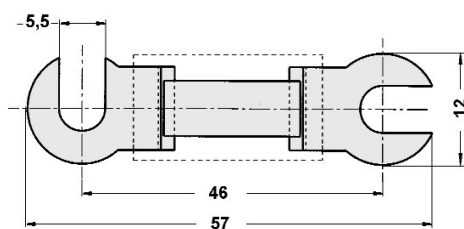

REF/pc.	AMP
123TA8540	10
127TA2268	15
124TA2766	20
124TA2767	30

STANDARD: JAPANESE

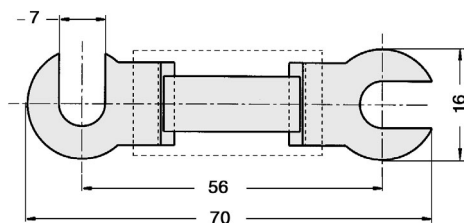

REF/pc.	AMP
119TA8942	40
119TA8943	50
119TA8944	60

STANDARD: JAPANESE

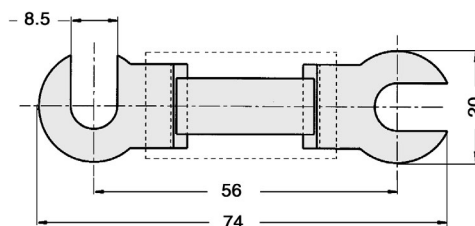

REF/pc.	AMP
103TA2903	75
119TA8941	100

STANDARD: JAPANESE

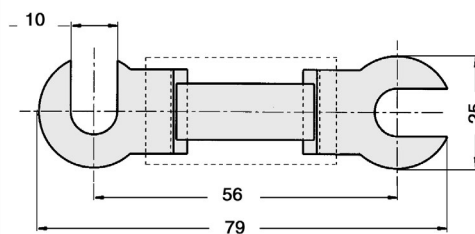

REF/pc.	AMP
103TA2904	150
103TA2905	200
127TA2269	250
103TA2906	300

AMP = Current (A) • SPEED IND. = Speed indication (SLOW, MEDIUM, FAST) • EX. AGENT = Extinguishing agent (sand)

2. FUSE PLUGS FOR AUTOMOTIVE USE

For all our latest catalogue updates and company info: www.tvh.com

FUSES

STANDARD: LOW PROFILE/MINI / FAST



1 REF =
1 box of 100 pieces !

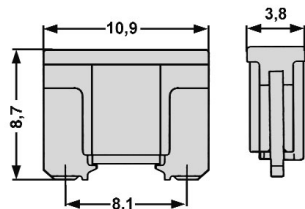

• Standard: 58 V

REF/100 pcs.	AMP
129TA7706	2
129TA7707	3
129TA7708	4
129TA7709	5
129TA7710	7,5
129TA7711	10
129TA7712	15
129TA7713	20
129TA7714	25
129TA7715	30

STANDARD: DIN72581/MINI / FAST



1 REF =
1 box of 50 pieces !

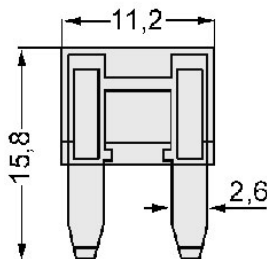

• Standard: 32 V
• With ex. agent (sand) YES: 125 V

REF/50 pcs.	AMP	EX. AGENT (sand)
127TA2089	2	
127TA2090	3	YES
127TA2091	3	
127TA2092	4	YES
127TA2093	4	
127TA2094	5	YES
127TA2095	5	
127TA2096	7,5	YES
127TA2097	7,5	
127TA2098	10	YES
127TA2099	10	
127TA2100	15	YES
127TA2101	15	
127TA2102	20	
127TA2103	25	
127TA2104	30	

STANDARD: DIN72581/MED / FAST



1 REF =
1 box of 100 pieces !

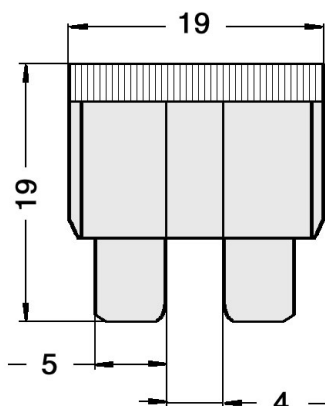

• Standard: 32 V
• With ex. agent (sand) YES: 80 V

REF/100 pcs.	AMP	EX. AGENT (sand)
127TA2105	1	
127TA2106	2	
127TA2107	3	YES
127TA2108	3	
127TA2109	4	YES
127TA2110	4	
127TA2111	5	YES
127TA2112	5	
127TA2113	7,5	YES
127TA2114	7,5	
127TA2115	10	YES
127TA2116	10	
127TA2117	15	YES
127TA2118	15	
127TA2119	20	YES
127TA2120	20	
127TA2121	25	YES
127TA2122	25	
127TA2123	30	YES
127TA2124	30	
127TA2125	35	
127TA2126	40	

AMP = Current (A) • SPEED IND. = Speed indication (SLOW, MEDIUM, FAST) • EX. AGENT = Extinguishing agent (sand)

2. FUSE PLUGS FOR AUTOMOTIVE USE

For all our latest catalogue updates and company info: www.tvh.com



FUSES

STANDARD: DIN72581-3/MED / FAST



1 REF =
1 box of 100 pieces!

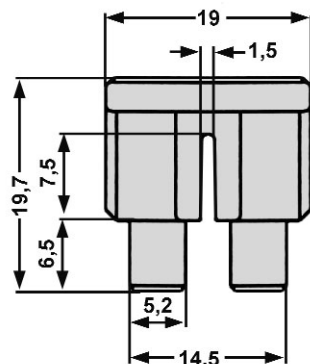

• Standard: 58 V

REF/100 pcs.	AMP
129TA7716	1
129TA7717	2
129TA7718	3
129TA7719	4
129TA7720	5
129TA7721	7,5
129TA7722	10
129TA7723	15
129TA7724	20
129TA7725	25
129TA7726	30
129TA7727	40

STANDARD: MED/RESET/FAST

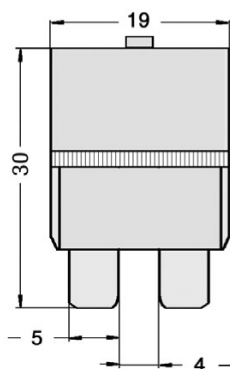

The complete range of MED/RESET/FAST fuses can be found further in this chapter listed under thermal function fuses/reset fuses with push button

STANDARD: DIN72581/MAXI / FAST



1 REF =
1 box of 10 pieces!

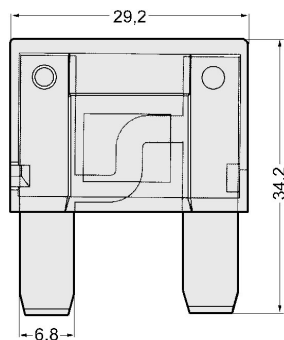
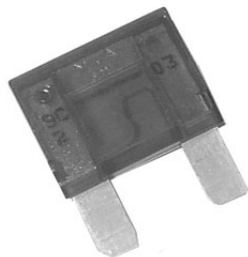

• Standard: 32 V
• With ex. agent (sand) YES: 80 V

REF/10 pcs.	AMP	EX. AGENT (sand)
127TA2127	20	YES
127TA2128	20	YES
127TA2129	30	YES
127TA2130	30	YES
127TA2131	40	YES
127TA2132	40	YES
127TA2133	50	YES
127TA2134	50	YES
127TA2135	60	YES
127TA2136	70	YES
127TA2137	80	YES
127TA2138	100	YES

2. FUSE PLUGS FOR AUTOMOTIVE USE

For all our latest catalogue updates and company info: www.tvh.com

FUSES

STANDARD: JAPANESE/LOW PROFILE JCASE

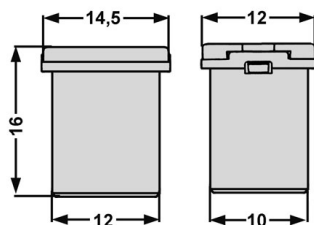

REF/pc.	AMP
129TA7736	20
129TA7729	25
129TA7730	30
129TA7731	40
129TA7732	50
129TA7733	60

STANDARD: JAPANESE/JCASE

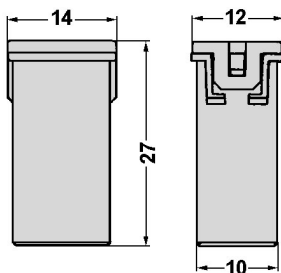

REF/pc.	AMP
127TA2270	20
127TA2271	30
127TA2272	40
127TA2273	50
127TA2274	60

STANDARD: JAPANESE/MINI-FEMALE

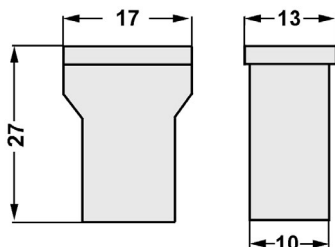

REF/pc.	AMP
127TA2275	20
106TA5097	30
106TA5098	40
124TA2768	50
127TA2276	60
127TA2277	70
127TA2278	80

STANDARD: JAPANESE/MINI-HOOK

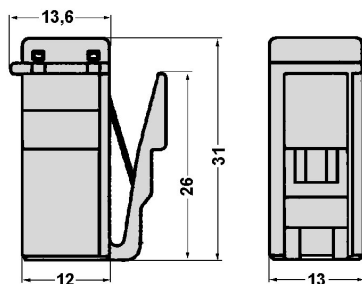

REF/pc.	AMP
127TA2279	25
127TA2280	30
127TA2281	40
127TA2282	50
127TA2283	60
127TA2284	70
127TA2285	80
127TA2286	100

STANDARD: JAPANESE/MAXI-HOOK

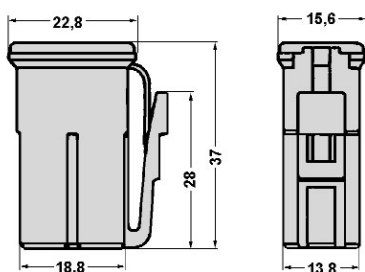

REF/pc.	AMP
127TA2287	45
127TA2288	65
127TA2289	75

AMP = Current (A) • SPEED IND. = Speed indication (SLOW, MEDIUM, FAST) • EX. AGENT = Extinguishing agent (sand)

2. FUSE PLUGS FOR AUTOMOTIVE USE



For all our latest catalogue updates and company info: www.tvh.com

FUSES

STANDARD: JAPANESE/FEMALE

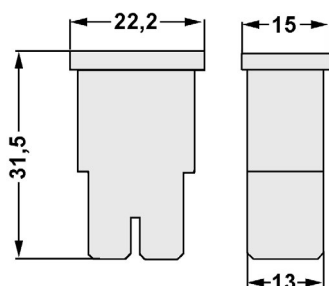

REF/pc.	AMP
106TA5080	20
106TA5081	30
106TA5082	40
106TA5123	50
106TA5084	60
127TA2290	70
106TA5085	80
106TA5086	100
127TA2291	120

STANDARD: JAPANESE/FEMALE

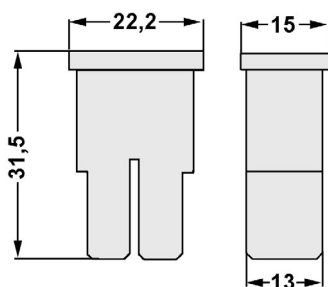

REF/pc.	AMP
123TA8541	20
123TA8542	30
123TA8543	40
123TA8544	50
123TA8545	60
127TA2292	70
123TA8546	80
123TA8547	100
127TA2293	120

STANDARD: JAPANESE/MALE

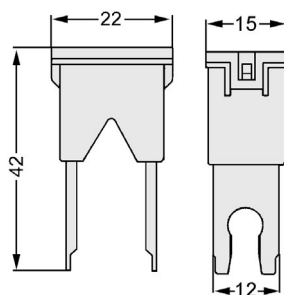

REF/pc.	AMP
127TA2294	20
106TA5087	30
106TA5088	40
106TA5089	50
106TA5090	60
127TA2295	70
106TA5091	80
106TA5092	100
106TA7094	120

STANDARD: JAPANESE/MALE

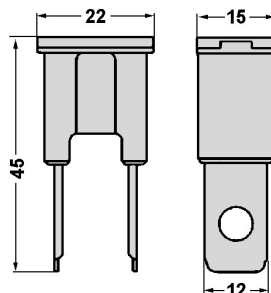

REF/pc.	AMP
127TA2296	20
127TA2297	30
127TA2298	40
127TA2299	50
127TA2300	60
127TA2301	70
127TA2302	80
127TA2303	100
127TA2304	120

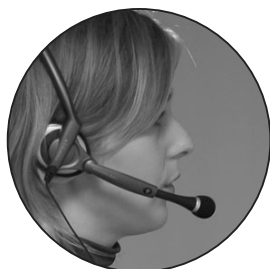

AMP = Current (A) • SPEED IND. = Speed indication (SLOW, MEDIUM, FAST) • EX. AGENT = Extinguishing agent (sand)

2. FUSE PLUGS FOR AUTOMOTIVE USE

For all our latest catalogue updates and company info: www.tvh.com

FUSES

STANDARD: JAPANESE/ 48 MM BENT-MALE

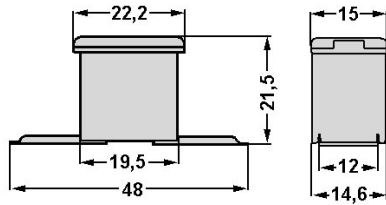

REF/pc.	AMP
127TA2305	20
127TA2306	30
127TA2307	40
127TA2308	50
127TA2309	60
127TA2310	70
127TA2311	80
127TA2312	100
127TA2313	120

STANDARD: JAPANESE/ 62 MM BENT-MALE

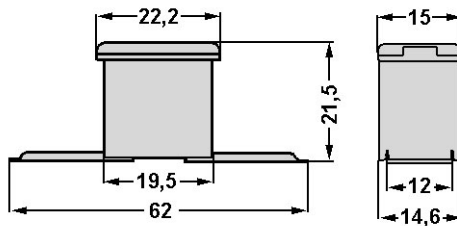
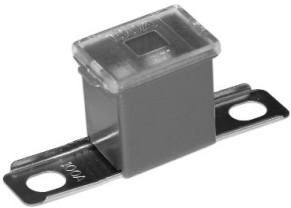

REF/pc.	AMP
127TA2314	20
127TA2315	30
127TA2316	40
127TA2317	50
127TA2318	60
127TA2319	70
127TA2320	80
127TA2321	100
127TA2322	120

Look up
these parts via



AMP = Current (A) • SPEED IND. = Speed indication (SLOW, MEDIUM, FAST) • EX. AGENT = Extinguishing agent (sand)

3. STUD-MOUNTED FUSES



For all our latest catalogue updates and company info: www.tvh.com

FUSES

STANDARD: HBO / SLOW

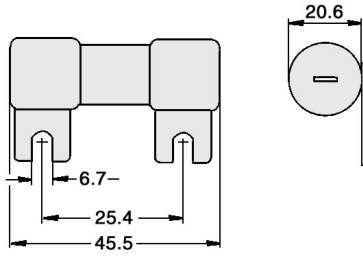

REF/pc.	AMP
111TA3444	60
111TA3445	125
111TA3446	150

STANDARD: HSK / FAST

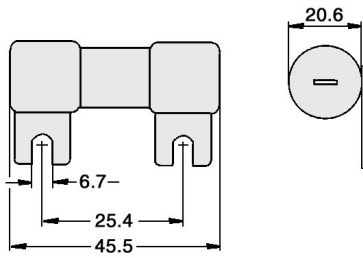

REF/pc.	AMP
103TA3033	40
103TA3034	60
103TA3035	80
103TA3036	100
103TA3037	125
103TA3038	400

STANDARD: ACK

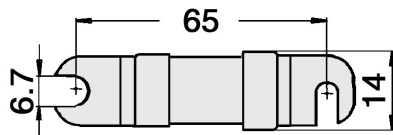

REF/pc.	AMP
103TA2982	20
106TA5095	30

STANDARD: ACK

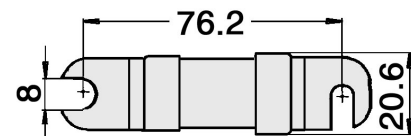

REF/pc.	AMP
103TA2804	35
103TA2805	40
103TA2806	50
103TA2807	60

STANDARD: ACK

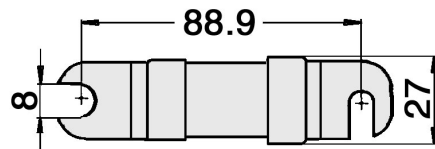

REF/pc.	AMP
103TA2808	70
103TA2809	75
103TA2810	80
103TA2811	90
103TA2812	100
103TA2813	120

STANDARD: ACK

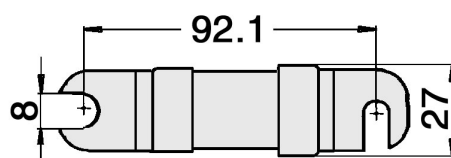

REF/pc.	AMP
103TA2817	140
103TA2818	150
103TA2819	160
103TA2820	175
103TA2821	200

AMP = Current (A) • SPEED IND. = Speed indication (SLOW, MEDIUM, FAST) • EX. AGENT = Extinguishing agent (sand)

3. STUD-MOUNTED FUSES

For all our latest catalogue updates and company info: www.tvh.com

FUSES

STANDARD: ACK

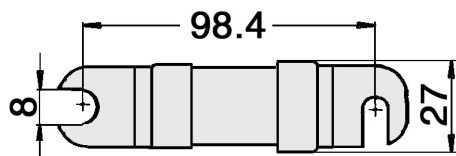

REF/pc.	AMP
103TA2814	225
103TA2815	250
103TA2816	300

STANDARD: ACL

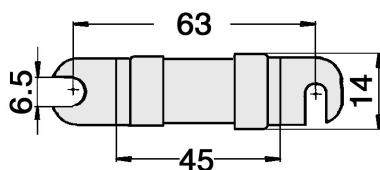

REF/pc.	AMP
103TA2797	30
103TA2798	40
103TA2799	50
103TA2800	60

STANDARD: ACL

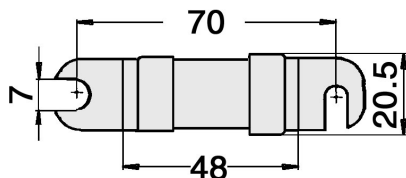

REF/pc.	AMP
103TA2801	80
106TA5094	90
103TA2802	100
103TA2803	120

STANDARD: ALS

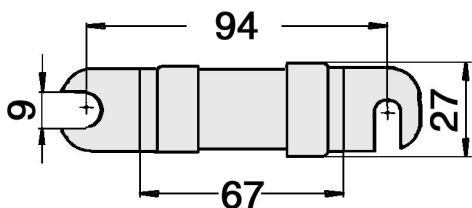

REF/pc.	AMP
103TA2980	150
103TA2979	175
106TA4972	200
103TA2981	225
103TA2991	250
103TA2792	300
103TA2793	350
103TA2794	400
103TA2978	450
103TA2795	500
103TA2977	550
103TA2796	600

AMP = Current (A) • SPEED IND. = Speed indication (SLOW, MEDIUM, FAST) • EX. AGENT = Extinguishing agent (sand)

3. STUD-MOUNTED FUSES



For all our latest catalogue updates and company info: www.tvh.com

FUSES

STANDARD: SPECIAL

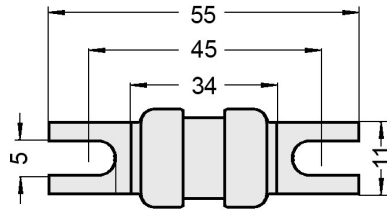

REF/pc.	AMP
140TA8476	2

STANDARD: SPECIAL

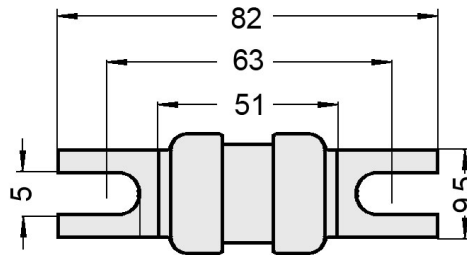

REF/pc.	AMP
140TA8477	2

STANDARD: LCT

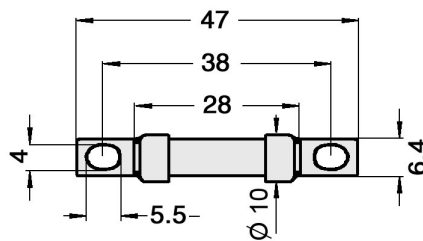

REF/pc.	AMP
103TA2855	6
103TA2856	10
103TA2857	12
129TA7734	15
103TA2858	16
103TA2859	20
124TA2769	25
124TA2770	32
129TA7734	15 (Ø 8 ISO 10 mm)
140TA8478	20 (Ø 8 ISO 10 mm)

STANDARD: LET

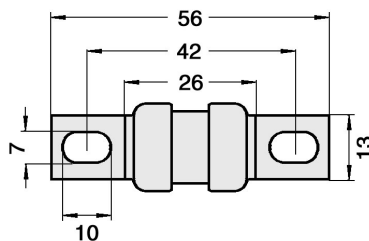

REF/pc.	AMP
103TA2860	25
127TA2323	30
103TA2862	35
103TA2863	50
103TA2864	63
103TA2984	75
103TA2865	80
103TA2866	100
103TA2867	125
127TA2324	150
103TA2868	160
103TA2869	180

AMP = Current (A) • SPEED IND. = Speed indication (SLOW, MEDIUM, FAST) • EX. AGENT = Extinguishing agent (sand)

3. STUD-MOUNTED FUSES

For all our latest catalogue updates and company info: www.tvh.com

FUSES

STANDARD: LMT

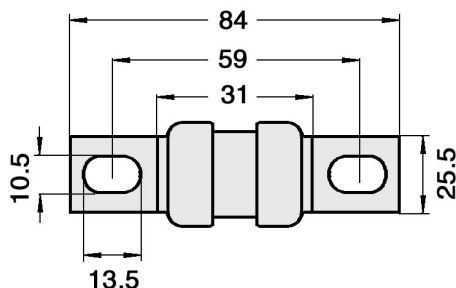

REF/pc.	AMP
127TA2325	100
127TA2326	125
103TA3031	150
103TA2870	160
103TA2871	200
103TA2872	250
103TA2873	315
103TA2874	355
103TA2875	400
103TA2876	450

STANDARD: LMT

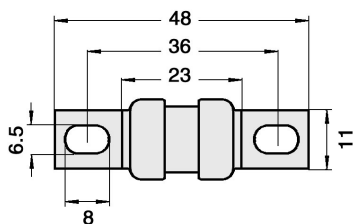

REF/pc.	AMP
103TA2987	500

STANDARD: KAA/A13X

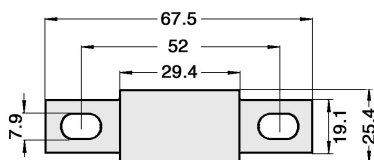
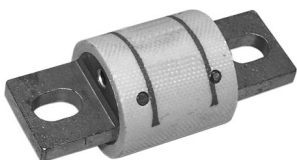

REF/pc.	AMP
103TA2877	100
103TA2878	130
103TA2879	150
103TA2880	200
103TA2881	250
103TA2882	300
103TA2883	350
103TA2884	400

STANDARD: KAB/FWX

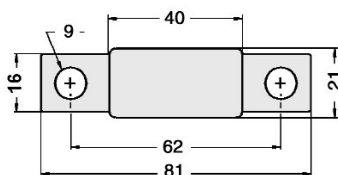
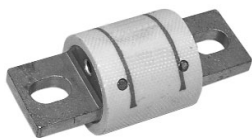

REF/pc.	AMP
103TA2775	35
106TA4961	40
103TA2776	45
105TA4708	50
103TA2777	60

STANDARD: KAB/FWX/A25X

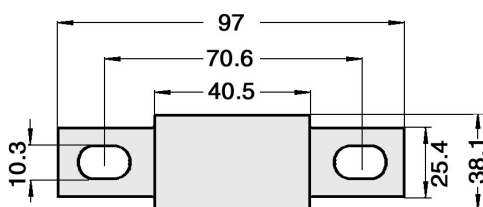

REF/pc.	AMP
103TA2885	250
103TA2886	350
103TA2887	400
103TA2888	450
103TA2889	600
103TA2890	700
103TA2891	800

AMP = Current (A) • SPEED IND. = Speed indication (SLOW, MEDIUM, FAST) • EX. AGENT = Extinguishing agent (sand)

4. KNIFE TYPE FUSES



For all our latest catalogue updates and company info: www.tvh.com

FUSES

STANDARD: VDE0636/23 NH00

• SLOW: ≤ 160 A

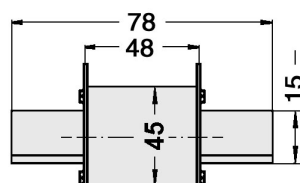
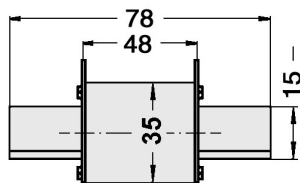

• FAST: ≤ 160 A

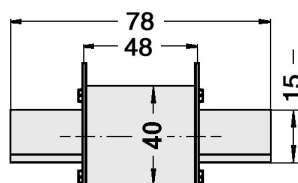

SLOW

INDICATOR ON TOP-PLATE

REF/pc.	AMP
119TA8949	16
106TA7051	20
106TA7052	25
106TA7053	35
106TA7054	50
106TA7055	63
106TA5035	80
103TA2950	100

INDICATOR ON MID-FRONT

REF/pc.	AMP
106TA7058	40
103TA2949	125
103TA2951	160

FAST

REF/pc.	AMP
103TA2946	50
103TA2947	63
103TA2948	80
106TA7056	100
106TA7057	125

STANDARD: VDE0636/23 NH0

• SLOW & FAST: ≤ 160 A

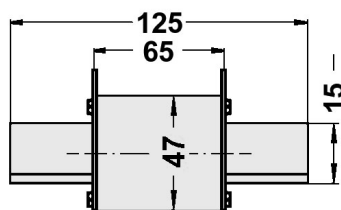

SLOW

REF/pc.	AMP
106TA7059	20
111TA2801	50
103TA2952	63
123TA8314	100
106TA7061	125
103TA2953	160

FAST

REF/pc.	AMP
106TA7062	80
106TA4991	100
103TA3044	125
106TA7063	160

4. KNIFE TYPE FUSES

For all our latest catalogue updates and company info: www.tvh.com

FUSES

STANDARD: VDE0636/23 NH1



• SLOW: ≤ 160 A

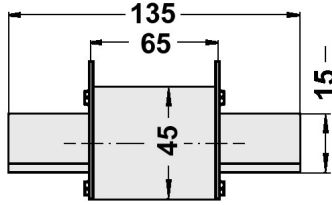

• SLOW: > 160 A

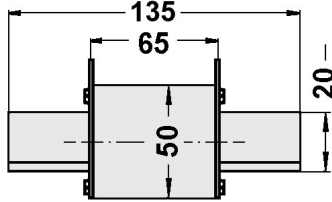

• FAST: ≤ 250 A

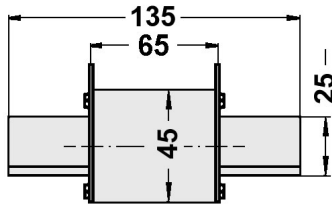

SLOW

REF/pc.	AMP
106TA7064	63
111TA2802	80
111TA2803	100
106TA7065	125
106TA7066	160
106TA7067	200
106TA7068	250

FAST

REF/pc.	AMP
103TA2954	125
103TA2955	200
103TA2956	250

Look up
these parts via



4. KNIFE TYPE FUSES



For all our latest catalogue updates and company info: www.tvh.com

FUSES

STANDARD: JAPANESE

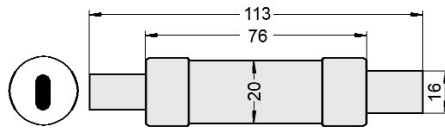

REF/pc.	AMP
140TA8479	50

STANDARD: NON/OT

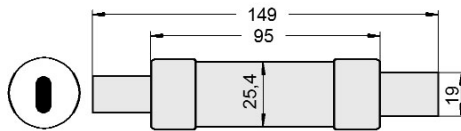

REF/pc.	AMP
103TA2841	70
103TA2842	80
103TA2843	90
103TA2844	100

STANDARD: NON/OT

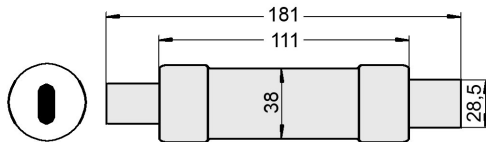

REF/pc.	AMP
103TA2845	110
103TA2846	125
103TA2847	150
103TA2848	175
103TA2849	200

STANDARD: NON/OT

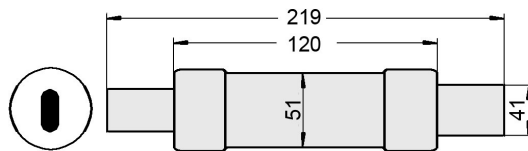

REF/pc.	AMP
103TA2850	225
103TA2851	250
103TA2852	300
103TA2853	350
103TA2854	400

STANDARD: NON

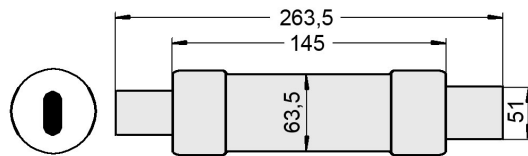

REF/pc.	AMP
103TA2838	450
103TA2839	500
103TA2840	600

STANDARD: FRN-R/TR-R / SLOW

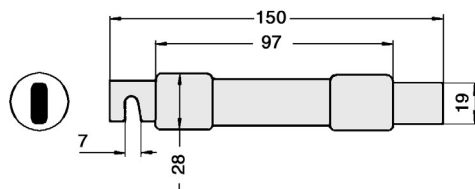

REF/pc.	AMP
103TA2834	70
103TA2835	80
103TA2836	90
103TA2837	100

AMP = Current (A) • SPEED IND. = Speed indication (SLOW, MEDIUM, FAST) • EX. AGENT = Extinguishing agent (sand)

5. SCREW TYPE FUSES

For all our latest catalogue updates and company info: www.tvh.com

FUSES

STANDARD: [DIN49522/D02](#)

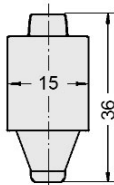

SLOW	
REF/pc.	AMP
140TA8480	50

STANDARD: [DIN49515/DII](#)

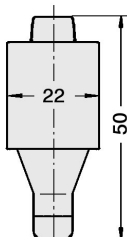

SLOW	
REF/pc.	AMP
111TA2806	6
103TA2988	16
103TA2989	20
103TA2990	25

FAST	
REF/pc.	AMP
111TA2804	4
111TA2805	6

STANDARD: [DIN49515/DIII](#)

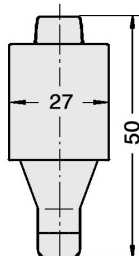

SLOW	
REF/pc.	AMP
103TA2991	35
103TA2992	50
103TA2993	63

FAST	
REF/pc.	AMP
106TA7069	35
106TA7070	50
106TA7071	63

STANDARD: [DIN49515/DIVH](#)

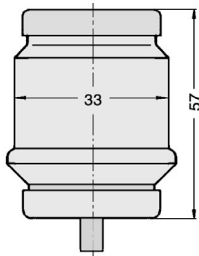

FAST	
REF/pc.	AMP
103TA2994	80
103TA2995	100

STANDARD: [DIN49515/DVH](#)

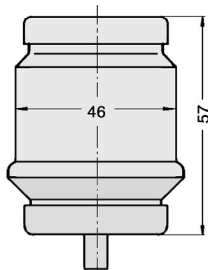

FAST	
REF/pc.	AMP
103TA2996	125
103TA2997	160

AMP = Current (A) • SPEED IND. = Speed indication (SLOW, MEDIUM, FAST) • EX. AGENT = Extinguishing agent (sand)

6. PLUG-IN FUSES



For all our latest catalogue updates and company info: www.tvh.com

FUSES

STANDARD: DIN41662 / SLOW



1 REF =
1 box of 100 pieces!

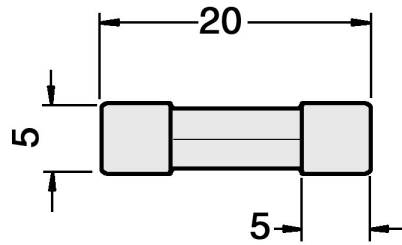

REF/100 pcs.	AMP	EX. AGENT (sand)
127TA2139	0,05	
127TA2140	0,063	
127TA2141	0,08	
127TA2142	0,1	
127TA2143	0,16	
127TA2144	0,2	
127TA2145	0,315	
127TA2146	0,4	
127TA2147	0,5	
127TA2148	0,630	
127TA2149	0,8	
127TA2150	1	
127TA2151	1,25	
127TA2152	1,6	
127TA2153	2	
127TA2154	3,15	
127TA2155	4	YES
127TA2156	5	
127TA2157	6,3	
127TA2158	8	
127TA2159	10	
127TA2160	10	YES
127TA2161	16	YES

STANDARD: DIN41571 / MEDIUM



1 REF =
1 box of 100 pieces!

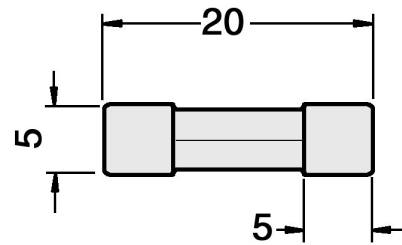

REF/100 pcs.	AMP	EX. AGENT (sand)
127TA2162	0,2	
127TA2163	0,315	
127TA2164	0,5	
127TA2165	1	
127TA2166	2	YES
127TA2167	2,5	YES
127TA2168	3,15	YES
127TA2169	4	YES
127TA2170	5	YES
127TA2171	6,3	YES
127TA2172	8	YES
127TA2173	10	YES
127TA2174	16	YES

STANDARD: DIN41661 / FAST



1 REF =
1 box of 100 pieces!

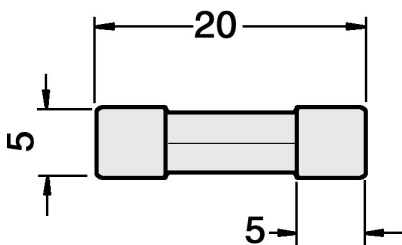

REF/100 pcs.	AMP	EX. AGENT (sand)
127TA2175	0,1	
127TA2176	0,2	
127TA2177	0,25	
127TA2178	0,4	
127TA2179	0,5	
127TA2180	0,63	
127TA2181	0,8	
127TA2182	1	
127TA2183	2	
127TA2184	2,5	
127TA2185	3,15	
127TA2186	4	
127TA2187	5	
127TA2188	6,3	
127TA2189	8	
127TA2190	10	
127TA2191	10	YES
140TA8481	12,5	YES
140TA8482	15	
127TA2192	16	YES
127TA2193	20	

AMP = Current (A) • SPEED IND. = Speed indication (SLOW, MEDIUM, FAST) • EX. AGENT = Extinguishing agent (sand)

6. PLUG-IN FUSES

For all our latest catalogue updates and company info: www.tvh.com

FUSES

STANDARD: DIN41576-1/FAST

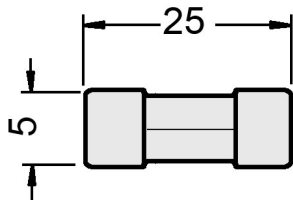

REF/pc.	AMP	EX. AGENT (sand)
140TA8483	4	YES

STANDARD: AGA / FAST

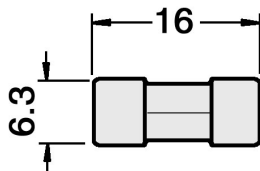

REF/pc.	AMP
103TA2919	4
103TA2920	5
103TA2921	10

STANDARD: AGW/SFE / FAST

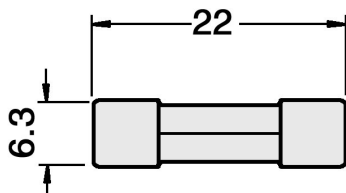

REF/pc.	AMP
103TA2915	1
123TA8343	2
123TA8344	3
123TA8345	4
103TA2916	5
123TA8346	6
103TA2917	9
123TA8347	10
123TA8348	15
103TA2918	20
123TA8349	25
123TA8350	30

STANDARD: AGX / FAST

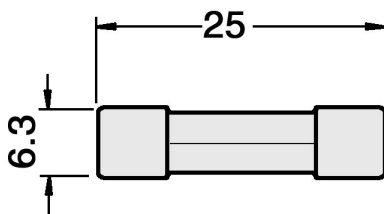

REF/pc.	AMP
103TA2932	0,25
123TA8352	1
123TA8353	2
103TA2933	3
123TA8354	4
123TA8355	5
123TA8356	6
123TA8357	7
103TA2934	8
123TA8358	10
103TA2935	15
103TA2936	20
123TA8359	25
103TA2937	30

STANDARD: SFE / FAST

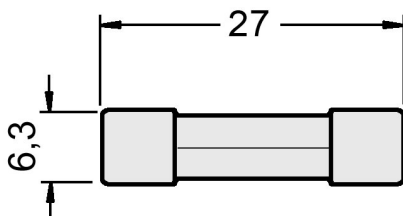

REF/pc.	AMP
106TA7146	14

AMP = Current (A) • SPEED IND. = Speed indication (SLOW, MEDIUM, FAST) • EX. AGENT = Extinguishing agent (sand)

6. PLUG-IN FUSES



For all our latest catalogue updates and company info: www.tvh.com

FUSES

STANDARD: BS105/C / FAST

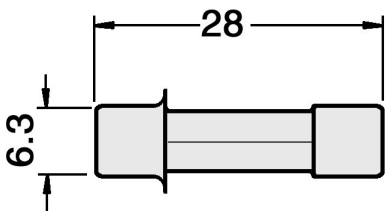

REF/pc.	AMP
103TA2922	1,25
103TA2923	2
103TA2928	20
103TA2929	25
103TA2930	30
103TA2931	35

STANDARD: DIN41668 / SLOW



1 REF =
1 box of 100 pieces!

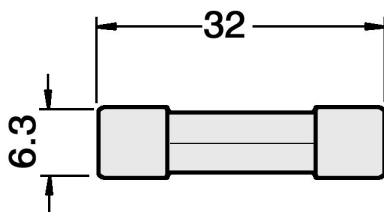

REF/100 pcs.	AMP	EX. AGENT (sand)
127TA2201	0,25	
127TA2202	1	
127TA2203	2	
127TA2204	3	
127TA2205	4	
127TA2206	5	
127TA2207	7	
127TA2208	8	
127TA2209	10	
127TA2210	10	YES
127TA2211	12,5	YES
127TA2212	15	
127TA2213	16	YES
127TA2214	20	
127TA2215	25	
127TA2216	30	
140TA8484	40	

STANDARD: DIN41668 / MEDIUM



1 REF =
1 box of 100 pieces!

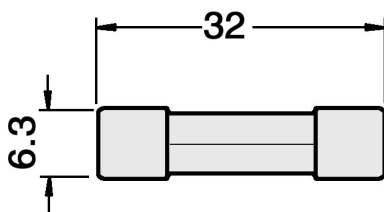

REF/100 pcs.	AMP	EX. AGENT (sand)
127TA2217	4	YES
127TA2218	7,5	
127TA2219	8	YES
127TA2220	10	
127TA2221	15	
127TA2222	25	
140TA8485	35	

STANDARD: DIN41668 / FAST



1 REF =
1 box of 100 pieces!

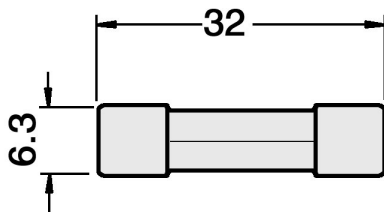

REF/100 pcs.	AMP	EX. AGENT (sand)
127TA2223	0,3	
127TA2224	0,5	
127TA2225	1	
127TA2226	2	
127TA2227	3	
127TA2228	4	
127TA2229	5	
127TA2230	6	
127TA2231	6,3	YES
127TA2232	7	
127TA2233	8	
127TA2234	8	YES
127TA2235	10	
127TA2236	15	
127TA2237	16	
127TA2238	20	
127TA2239	25	
127TA2240	30	
127TA2241	35	

AMP = Current (A) • SPEED IND. = Speed indication (SLOW, MEDIUM, FAST) • EX. AGENT = Extinguishing agent (sand)

6. PLUG-IN FUSES

For all our latest catalogue updates and company info: www.tvh.com

FUSES

STANDARD: DIN41660 / CERAMIC / FAST



1 REF =
1 box of 100 pieces!

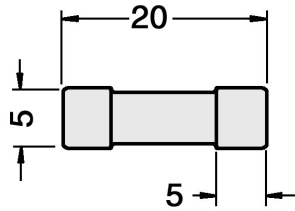

REF/100 pcs.	AMP	EX. AGENT (sand)
127TA2194	2	YES
127TA2195	2,5	YES
127TA2196	4	YES
127TA2197	5	YES
127TA2198	6,3	YES
127TA2199	10	YES
127TA2200	12,5	YES
140TA8486	3,15	YES FF

STANDARD: MDA/CERAMIC / SLOW



1 REF =
1 box of 100 pieces!

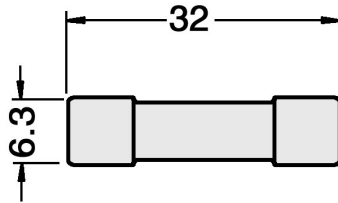

REF/100 pcs.	AMP	EX. AGENT (sand)
127TA2248	10	YES
127TA2249	12	YES
127TA2250	25	YES

STANDARD: ABC/CERAMIC / FAST



1 REF =
1 box of 100 pieces!

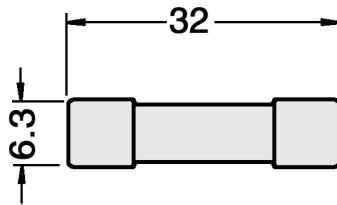

REF/100 pcs.	AMP	EX. AGENT (sand)
127TA2251	0,75	YES
127TA2252	1	YES
127TA2253	2	YES
127TA2254	3	YES
127TA2255	3,15	YES
127TA2256	4	YES
127TA2257	5	YES
127TA2258	6	YES
127TA2259	7	YES
127TA2260	8	YES
127TA2261	10	YES
127TA2262	15	YES
127TA2263	16	YES
127TA2264	20	YES
127TA2265	25	YES
127TA2266	30	YES

STANDARD: BBS/600 V / FAST

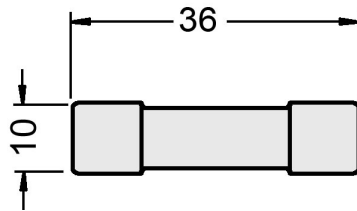

REF/pc.	AMP
140TA8487	30

STANDARD: KTK/600 V / FAST

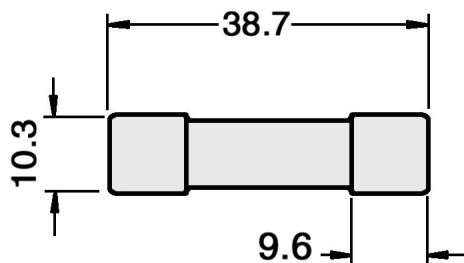

REF/pc.	AMP
106TA7095	0,3
106TA7096	0,5
129TA7735	3
106TA7097	5
106TA7098	6
106TA7099	9
106TA7100	10
106TA7101	15
106TA7102	20
106TA7103	25
106TA7104	30
106TA4984	50

AMP = Current (A) • SPEED IND. = Speed indication (SLOW, MEDIUM, FAST) • EX. AGENT = Extinguishing agent (sand)

6. PLUG-IN FUSES



For all our latest catalogue updates and company info: www.tvh.com

FUSES

STANDARD: FNM / SLOW

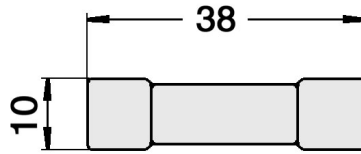

REF/pc.	AMP
103TA2907	1
103TA2908	2
103TA2909	4
140TA8488	8
103TA2910	15
140TA8489	16
103TA2911	20
103TA2912	25
103TA2913	30
111TA3435	32
103TA2914	40

STANDARD: BAN/CE269-2 / FAST

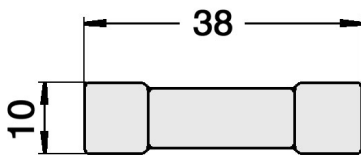

REF/pc.	AMP
103TA2778	1
106TA4962	3
103TA2779	6
103TA2780	8
103TA2781	10
127TA2335	12
103TA2782	15
103TA2983	16
103TA2783	20
106TA4963	25
106TA4964	30
103TA2784	32

STANDARD: CE269-2

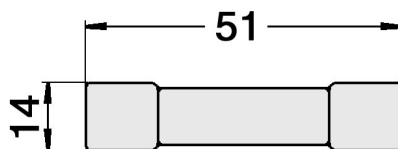

MEDIUM	
REF/pc.	AMP
103TA2900	4
103TA2899	6
103TA2901	20
103TA2902	32

FAST	
REF/pc.	AMP
103TA2893	2
103TA2894	6
103TA2895	16
103TA2896	20
103TA2897	32
103TA2898	40
103TA2892	50

STANDARD: NON/OT

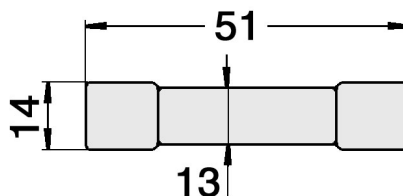

REF/pc.	AMP
106TA4966	1
106TA4967	3
103TA3023	5
106TA4968	6
103TA2789	10
106TA4969	15
106TA4970	20
106TA4971	25
103TA2790	30

AMP = Current (A) • SPEED IND. = Speed indication (SLOW, MEDIUM, FAST) • EX. AGENT = Extinguishing agent (sand)

6. PLUG-IN FUSES

For all our latest catalogue updates and company info: www.tvh.com

FUSES

STANDARD: LPJ / SLOW

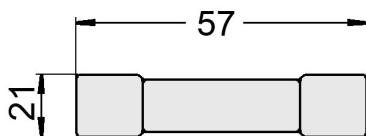

REF/pc.	AMP
140TA8490	5

STANDARD: NON/OT

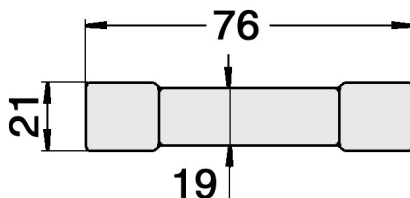

REF/pc.	AMP
103TA2785	35
103TA2786	40
106TA4965	45
103TA2787	50
103TA2788	60

STANDARD: CE269-2

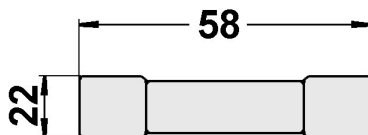

SLOW	
REF/pc.	AMP
123TA8376	32
123TA8380	100

FAST	
REF/pc.	AMP
123TA8374	6
123TA8375	32
123TA8377	40
123TA8378	80
123TA8379	100
123TA8381	125

STANDARD: SC / AG / SLOW

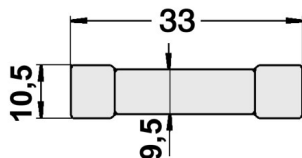

REF/pc.	AMP
103TA2938	5
103TA3024	10
103TA2939	15

STANDARD: SC / SLOW

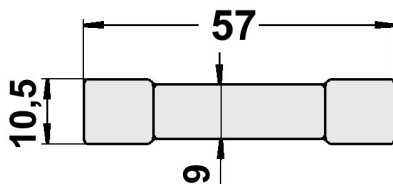

REF/pc.	AMP
103TA2940	60

AMP = Current (A) • SPEED IND. = Speed indication (SLOW, MEDIUM, FAST) • EX. AGENT = Extinguishing agent (sand)

6. PLUG-IN FUSES



For all our latest catalogue updates and company info: www.tvh.com

FUSES

STANDARD: FRN-R/TR-R / SLOW

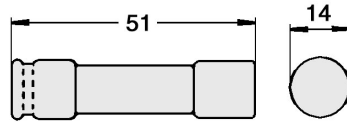

REF/pc.	AMP
103TA2822	10
103TA2823	12
103TA2824	15
103TA2825	17,5
103TA2826	20
103TA2827	25
103TA2828	30

STANDARD: FRN-R/TR-R / SLOW

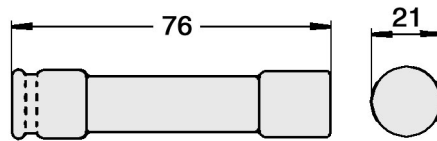

REF/pc.	AMP
103TA2829	35
103TA2830	40
103TA2831	45
103TA2832	50
103TA2833	60

STANDARD: FRS-R / SLOW

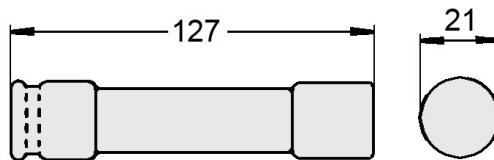

REF/pc.	AMP
140TA8491	2

STANDARD: SPECIAL

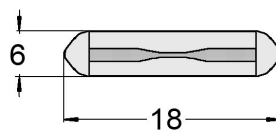

REF/pc.	AMP
140TA8492	25

STANDARD: DIN72581/1



1 REF =
1 box of 100 pieces!

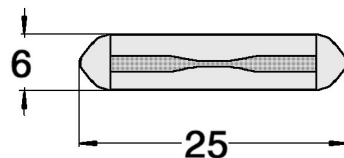

REF/100 pcs.	AMP
127TA2242	5
127TA2243	8
127TA2244	10
127TA2245	16
127TA2246	25
127TA2247	40

7. SUB-MINIATURE FUSES

For all our latest catalogue updates and company info: www.tvh.com

FUSES

STANDARD: SUB-MINIATURE FUSES



REF/pc.	AMP
106TA5060	5
106TA5061	15

8. SPECIAL FUSES

STANDARD: CLARK/CF8

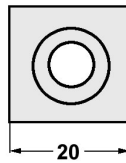
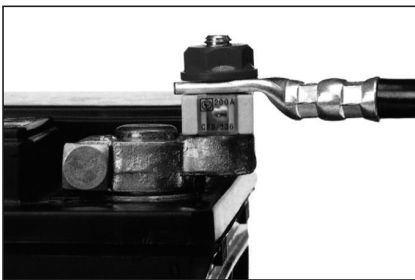

REF/pc.	AMP
106TA6926	50
106TA5059	75
111TA4011	100
123TA8382	125
123TA8383	150
123TA8384	175
123TA8385	200
123TA8386	250
123TA8387	300

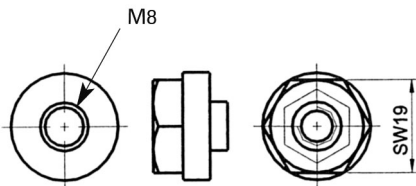

INSULATING NUT

REF/pc.
123TA8388

Look up
these parts via



9. FUSE KIT

For all our latest catalogue updates and company info: www.tvh.com





FUSES

FUSE KIT



REF/KIT
129TA7751

 DIN 43560/1/ FAST (11 mm)	Qty.	AMP
	5	35 A
	5	40 A
	5	50 A
	5	63 A
	5	80 A
	5	100 A
	5	125 A
	5	150 A
	5	175 A
	5	200 A
	5	225 A
	5	250 A
 DIN 72561/2/ SLOW	Qty.	AMP
	5	50 A
	5	80 A
	5	100 A
	5	150 A
5	250 A	

AMP = Current (A) • SPEED IND. = Speed indication (SLOW, MEDIUM, FAST) • EX. AGENT = Extinguishing agent (sand)



9. FUSE KIT





For all our latest catalogue updates and company info: www.tvh.com

FUSES

FUSE KIT



REF/KIT
129TA7752

 DIN 72581/MED	Qty.	AMP
	10	3 A
	10	5 A
	10	10 A
	10	15 A
	10	20 A
	10	30 A
 DIN 72581/1	Qty.	AMP
	10	5 A
	10	8 A
	10	10 A
	10	16 A
	10	25 A
 DIN 41661/FAST	Qty.	AMP
	10	5 A
	10	10 A
	10	16 A
 DIN 41668/FAST	Qty.	AMP
	10	10 A
	10	15 A
	10	20 A
	10	30 A

AMP = Current (A) • SPEED IND. = Speed indication (SLOW, MEDIUM, FAST) • EX. AGENT = Extinguishing agent (sand)

9. FUSE KIT

For all our latest catalogue updates and company info: www.tvh.com







FUSES

FUSE KIT



REF/KIT
123TA8414

 DIN 72581/MED	Qty.	AMP
	10	5 A
	10	7,5 A
	50	10 A
	50	15 A
	25	20 A
	10	25 A
25	30 A	
 DIN 72581/1	Qty.	AMP
	10	5 A
	50	8 A
	50	16 A
	10	25 A
 DIN 41661/FAST	Qty.	AMP
	25	2 A
	10	5 A
 DIN 41668/FAST	Qty.	AMP
	25	10 A
	25	15 A
	15	20 A

AMP = Current (A) • SPEED IND. = Speed indication (SLOW, MEDIUM, FAST) • EX. AGENT = Extinguishing agent (sand)



9. FUSE KIT



For all our latest catalogue updates and company info: www.tvh.com

FUSES

FUSE KIT

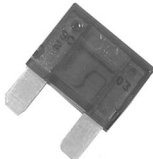

REF/KIT
129TA7753

 DIN 72581/ MINI	Qty.	AMP
	15	5 A
	15	7,5 A
	15	10 A
	15	15 A
	15	20 A
	15	25 A
	15	30 A
 DIN 72581/ MED	Qty.	AMP
	20	5 A
	20	7,5 A
	20	10 A
	20	15 A
	20	20 A
	20	25 A
	20	30 A
 DIN 72581/ MAXI	Qty.	AMP
	3	30 A
	3	40 A
	2	50 A
	2	60 A

AMP = Current (A) • SPEED IND. = Speed indication (SLOW, MEDIUM, FAST) • EX. AGENT = Extinguishing agent (sand)

10. AUTOMATIC FUSES

For all our latest catalogue updates and company info: www.tvh.com



FUSES

THERMAL FUNCTION ONLY

RESET AUTOMATIC

12 VDC

Used for: Ottawa, Sisu

REF/pc.	AMP	TERMINALS
141TA1402	7,5	BLADE
141TA1404	10	BLADE
141TA1405	15	BLADE
141TA1401	20	BLADE
141TA1403	30	BLADE

12 VDC

Used for: Crown, Yale

REF/pc.	AMP
141TA1489	50

12 VDC

Used for: Bobcat, Clark

REF/pc.	AMP
141TA1490	25

12 VDC

Used for: Ottawa

REF/pc.	AMP
141TA1487	30

12 VDC

Used for: Crown

REF/pc.	AMP
141TA1451	25
141TA1453	35

AMP = Current (A) • SPEED IND. = Speed indication (SLOW, MEDIUM, FAST) • EX. AGENT = Extinguishing agent (sand)

10. AUTOMATIC FUSES

For all our latest catalogue updates and company info: www.tvh.com

FUSES

12 VDC

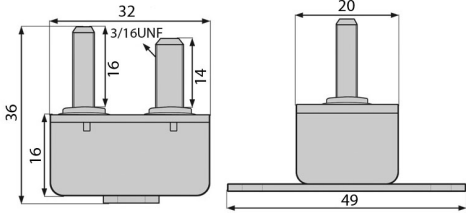
Used for: Genie, JLG

REF/pc.	AMP
126TA5480	5
141TA1494	10
126TA5474	30

12 VDC

Used for: JLG

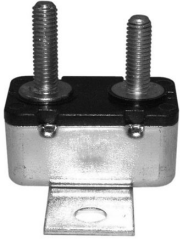
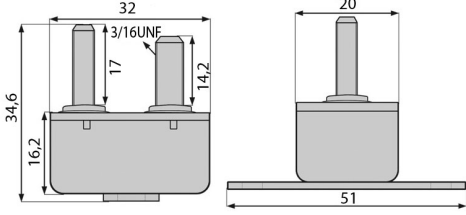
REF/pc.	AMP
126TA5477	15
122TA7789	20
141TA1493	30

24 VDC

Used for: BT, Komatsu, Prime Mover

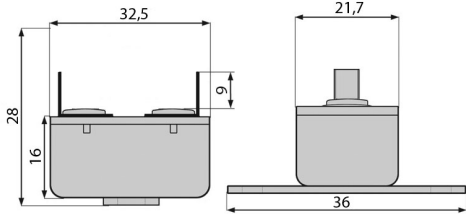
REF/pc.	AMP
141TA1492	12

30 VDC

Used for: Clark, Caterpillar, Komatsu, Mitsubishi

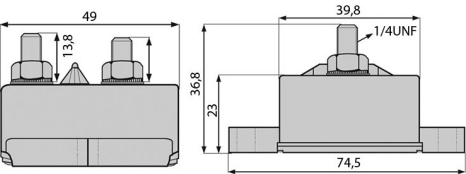
REF/pc.	AMP
141TA1491	80

30 VDC/120 VAC

Used for: Crown

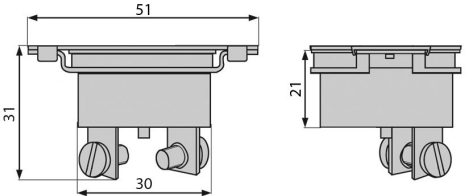
REF/pc.	AMP
141TA1444	12
141TA1445	25

10. AUTOMATIC FUSES



For all our latest catalogue updates and company info: www.tvh.com

FUSES

RESET WITH ROCKER SWITCH

32 VDC/250 VAC

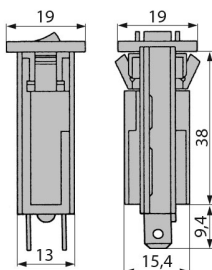

Used for: Genie, JLG

REF/pc.	AMP	TERMINALS
141TA1417	2	BLADE
122TA7777	3	BLADE
141TA1415	7	BLADE
141TA3578	8	BLADE
141TA3579	10	BLADE
141TA3580	12	BLADE
141TA3581	15	BLADE
126TA5475	20	BLADE

50 VDC/250 VAC

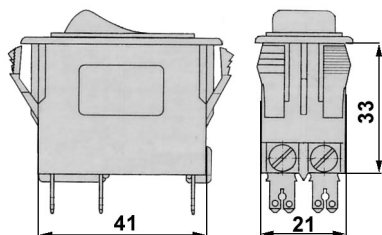

Used for: Komatsu, Steinbock

REF/pc.	AMP	TERMINALS
108TA4159	10	BLADE

60 VDC/240 VAC

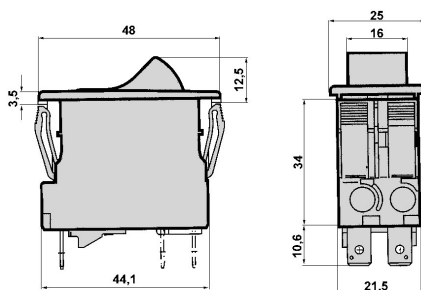

Used for: Hyster



DUST COVER

WITHOUT DUST COVER

REF/pc.	AMP	TERMINALS
108TA4160	7	BLADE
108TA4161	9	BLADE
108TA4162	10	BLADE
108TA4163	12	BLADE

WITH DUST COVER

REF/pc.	AMP	TERMINALS
141TA1398	7	BLADE
141TA1399	9	BLADE
141TA1400	10	BLADE

REF/pc.

[108TA4164](#)



10. AUTOMATIC FUSES

For all our latest catalogue updates and company info: www.tvh.com

FUSES

RESET WITH PUSH BUTTON

50 VDC/250 VAC

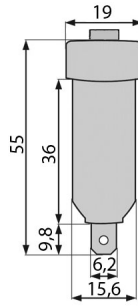

Used for: Tennant

REF/pc.	AMP	TERMINALS
140TA6583	1	BLADE
139TA6984	2,5	BLADE
139TA6933	10	BLADE
139TA6934	15	BLADE

STANDARD: MED/RESET/FAST

24 VDC

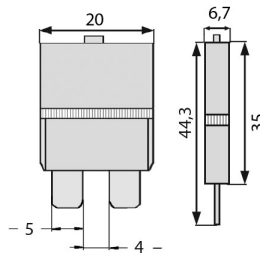

Used for: Kalmar, Ottawa, Sisu

REF/pc.	AMP	TERMINALS
141TA1406	10	BLADE
141TA3582	15	BLADE

28 VDC

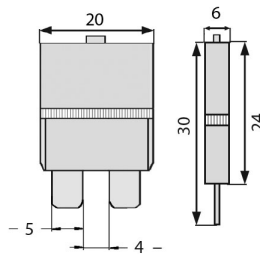

Used for: Terberg

REF/pc.	AMP	TERMINALS
141TA1409	6	BLADE
141TA3583	8	BLADE
141TA1410	10	BLADE
141TA3584	15	BLADE
141TA3585	20	BLADE
141TA1411	25	BLADE

32 VDC

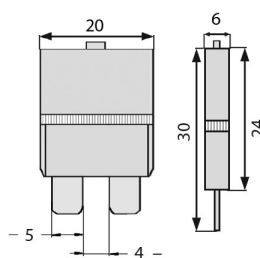

Used for: Hyster, Sisu

REF/pc.	AMP	TERMINALS
141TA3586	6	BLADE
141TA3587	10	BLADE
141TA3588	20	BLADE
141TA1407	25	BLADE

32 VDC

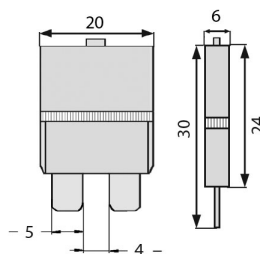
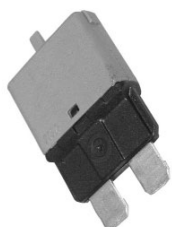

REF/pc.	AMP	TERMINALS
123TA8306	5	BLADE
123TA8307	7,5	BLADE
123TA8308	10	BLADE
123TA8309	15	BLADE
123TA8310	20	BLADE
123TA8311	25	BLADE
123TA8312	30	BLADE
123TA8313	40	BLADE

AMP = Current (A) • SPEED IND. = Speed indication (SLOW, MEDIUM, FAST) • EX. AGENT = Extinguishing agent (sand)

10. AUTOMATIC FUSES



For all our latest catalogue updates and company info: www.tvh.com

FUSES

12/24 VDC

Used for: Hyster, Yale

REF/pc.	AMP
141TA1488	50

30 VDC/120 VAC

Used for: Tennant

REF/pc.	AMP
141TA1446	20
141TA1447	30

30 VDC/120 VAC

Used for: Genie

REF/pc.	AMP
141TA1448	20
141TA3589	25

Used for: Tennant

REF/pc.	AMP
141TA1449	80

Used for: Clark

REF/pc.	AMP
141TA1450	50

10. AUTOMATIC FUSES

For all our latest catalogue updates and company info: www.tvh.com

FUSES

28 VDC/240 VAC

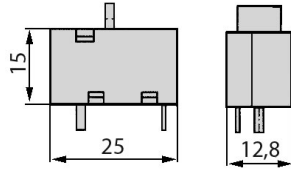

REF/pc.	AMP	TERMINALS
108TA4165	8	BLADE

250 VAC

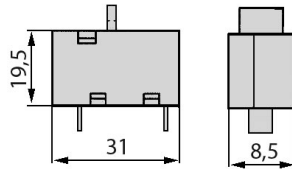
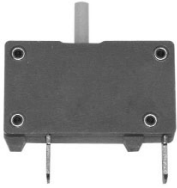

Used for: Charlatte, Jungheinrich, Steinbock, Caterpillar

REF/pc.	AMP	TERMINALS
141TA1413	10	BLADE
141TA1412	20	BLADE

48 VDC/415 VAC

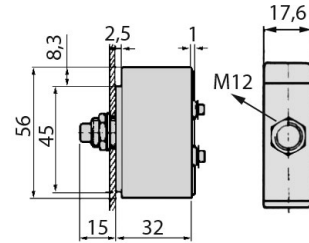
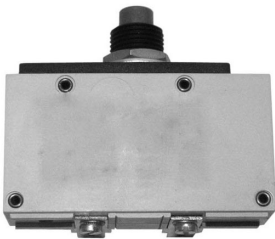

Used for: MIC, Jungheinrich

REF/pc.	AMP	TERMINALS
108TA4177	15	BLADE
108TA4178	20	BLADE

48 VDC/415 VAC

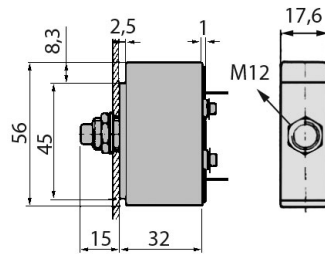
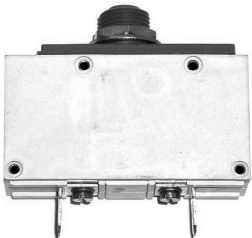

Used for: MIC, Steinbock, Jungheinrich

REF/pc.	AMP	TERMINALS
141TA1529	20	BLADE
108TA4179	25	BLADE

28 VDC/240 VAC

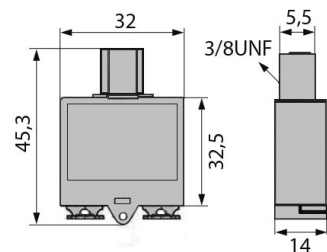

Used for: JLG

REF/pc.	AMP	TERMINALS
141TA1443	7	SCREW

28 VDC/240 VAC

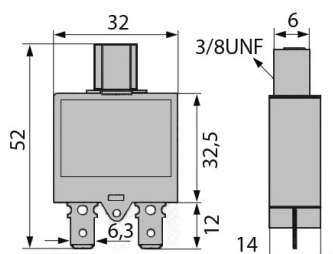

Used for: Clark, Genie

REF/pc.	AMP	TERMINALS
141TA1425	5	BLADE
128TA3081	7	BLADE
141TA3590	8	BLADE
139TA1776	10	BLADE
141TA1426	12	BLADE
139TA1777	15	BLADE
139TA1778	20	BLADE

AMP = Current (A) • SPEED IND. = Speed indication (SLOW, MEDIUM, FAST) • EX. AGENT = Extinguishing agent (sand)

10. AUTOMATIC FUSES



For all our latest catalogue updates and company info: www.tvh.com

FUSES

32 VDC / 125/250 VAC

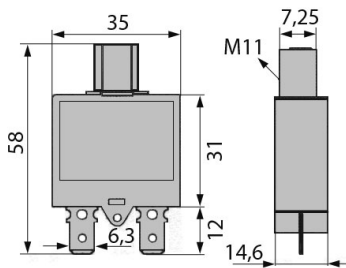

Used for: Tennant

REF/pc.	AMP	TERMINALS
141TA1431	25	BLADE

32 VDC / 125/250 VAC

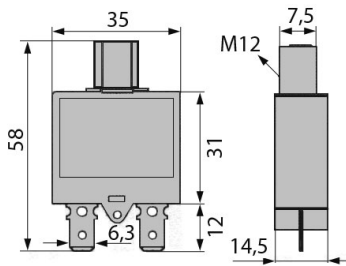
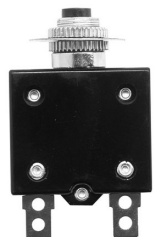

Used for: Dulevo

REF/pc.	AMP	TERMINALS
141TA1435	20	BLADE

50 VDC/240 VAC

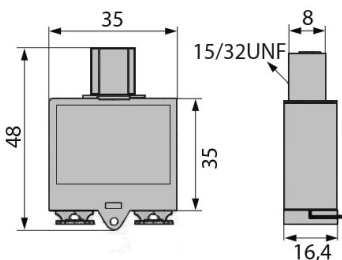

Used for: All-pro, JLG

REF/pc.	AMP	TERMINALS
141TA3598	3	SCREW
141TA1434	25	SCREW

50 VDC/250 VAC

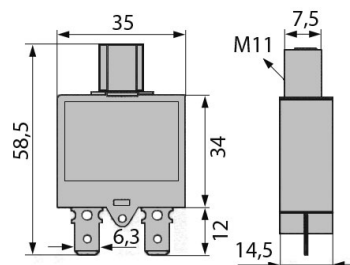

Used for: JLG, Grove, Snorkel, Tennant

REF/pc.	AMP	TERMINALS
141TA3576	3	BLADE
122TA7779	5	BLADE
141TA3600	7	BLADE
122TA7782	10	BLADE
122TA7783	15	BLADE
141TA1422	20	BLADE
141TA1427	25	BLADE
141TA3599	30	BLADE

50 VDC / 125/250 VAC

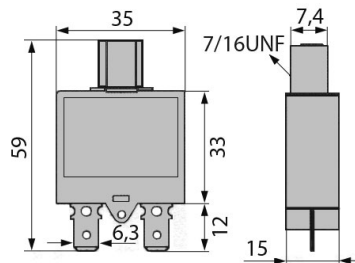

Used for: Niftylift

REF/pc.	AMP	TERMINALS
141TA1430	10	BLADE

10. AUTOMATIC FUSES

For all our latest catalogue updates and company info: www.tvh.com

FUSES

50 VDC/250 VAC

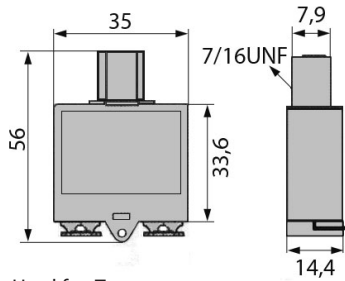

Used for: Tennant

REF/pc.	AMP	TERMINALS
141TA1429	15	SCREW
141TA3601	20	SCREW
141TA1428	30	SCREW

50 VDC/250 VAC

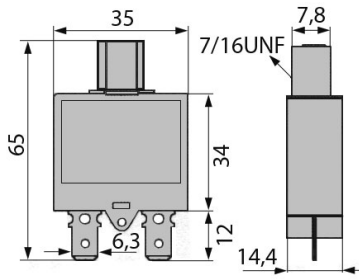

Used for: Minuteman, Powerboss, JLG, Tennant

WITHOUT DUST COVER		
REF/pc.	AMP	TERMINALS
141TA3602	6	BLADE
141TA1424	30	BLADE
122TA7786	35	BLADE
WITH DUST COVER		
REF/pc.	AMP	TERMINALS
139TA6909	5	BLADE
140TA6563	10	BLADE
140TA6327	15	BLADE
139TA6906	20	BLADE
139TA6907	25	BLADE

125 VDC/250 VAC

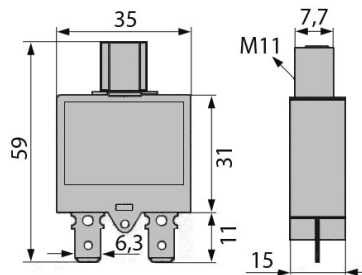

Used for: Trek cleaning machines

WITHOUT DUST COVER		
REF/pc.	AMP	TERMINALS
141TA1432	37	BLADE
WITH DUST COVER		
REF/pc.	AMP	TERMINALS
141TA3603	10	BLADE
141TA1420	25	BLADE
141TA3604	30	BLADE
141TA1421	37	BLADE

125/250 VAC

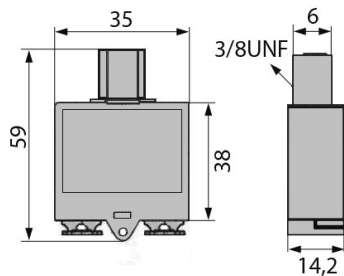

Used for: Clark, Jungheinrich, Yale, Tennant, Toyota

WITHOUT DUST COVER		
REF/pc.	AMP	TERMINALS
109TA5969	70	SCREW
WITH DUST COVER		
REF/pc.	AMP	TERMINALS
139TA6908	40	SCREW

AMP = Current (A) • SPEED IND. = Speed indication (SLOW, MEDIUM, FAST) • EX. AGENT = Extinguishing agent (sand)

10. AUTOMATIC FUSES



For all our latest catalogue updates and company info: www.tvh.com

FUSES

28 VDC/115 VAC

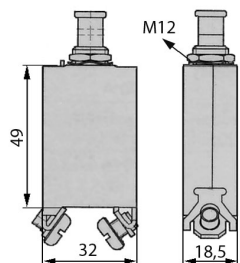

Used for: Clark

DUST COVER

REF/pc.	AMP	TERMINALS
141TA3605	30	SCREW
127TA2346	50	SCREW
108TA4180	70	SCREW

REF/pc.		
123TA8389		

28 VDC/240 VAC

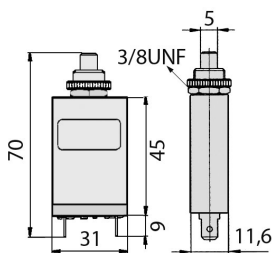
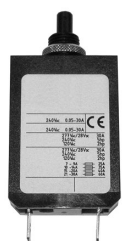

Used for: Genie, Tennant

REF/pc.	AMP	TERMINALS
141TA3606	4	BLADE
141TA3607	6	BLADE
141TA1441	10	BLADE
128TA3083	15	BLADE

28 VDC/250 VAC

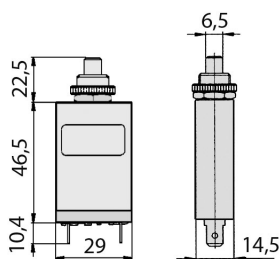

Used for: MIC, Steinbock, Jungheinrich

WITHOUT DUST COVER			
REF/pc.	AMP	THREAD	TERMINALS
108TA4168	10	3/8	BLADE
106TA6925	12	3/8	BLADE
103TA2943	15	3/8	BLADE
108TA4170	20	3/8	BLADE
141TA1436	8	M12	BLADE
141TA1438	10	M12	BLADE
108TA4169	15	M12	BLADE
141TA1437	16	M12	BLADE
108TA4171	25	M12	BLADE
WITH DUST COVER			
REF/pc.	AMP	THREAD	TERMINALS
138TA7186	10	M12	BLADE

28 VDC/250 VAC

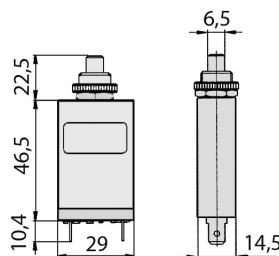

Used for: Still, Jungheinrich

DUST COVER

WITHOUT DUST COVER			
REF/pc.	AMP	THREAD	TERMINALS
108TA4172	4	3/8	SCREW
108TA4173	10	M12	SCREW
108TA4174	16	M12	SCREW
108TA4175	25	M12	SCREW
108TA4176	35	M12	SCREW
WITH DUST COVER			
REF/pc.	AMP	THREAD	TERMINALS
138TA7187	5	3/8	SCREW
141TA3610	20	3/8	SCREW
REF/pc.		THREAD	
141TA3608		3/8	
141TA3609		M12	

AMP = Current (A) • SPEED IND. = Speed indication (SLOW, MEDIUM, FAST) • EX. AGENT = Extinguishing agent (sand)

10. AUTOMATIC FUSES

For all our latest catalogue updates and company info: www.tvh.com

FUSES

48 VDC/240 VAC

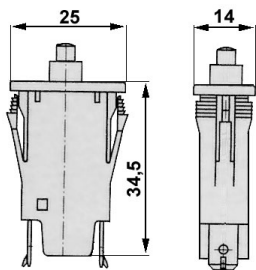

Used for: Genie

REF/pc.	AMP	TERMINALS
141TA3611	15	BLADE
108TA4166	16	BLADE

48 VDC/240 VAC

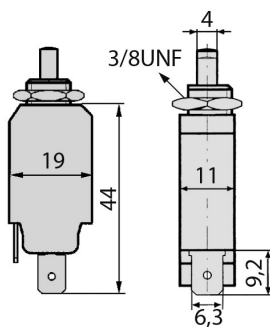

REF/pc.	AMP	TERMINALS
127TA2344	5	BLADE
108TA4167	15	BLADE
127TA2345	16	BLADE

50 VDC/250 VAC

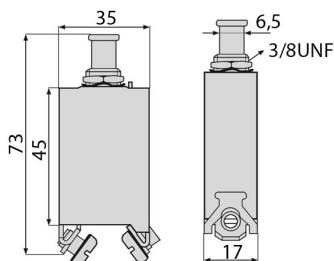

Used for: Genie, JLG

REF/pc.	AMP	TERMINALS
122TA7780	7,5	SCREW
122TA7787	50	SCREW

48 VDC/240 VAC

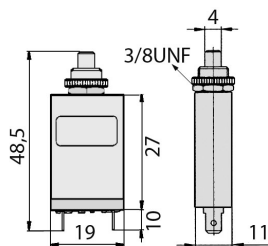

Used for: Jungheinrich, Moffett

REF/pc.	AMP	TERMINALS
141TA1439	3	BLADE
141TA1440	4,5	BLADE

50 VDC/240 VAC

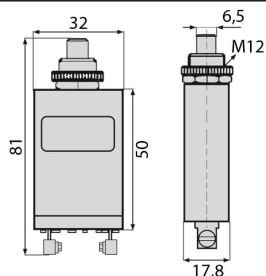

Used for: Jungheinrich

REF/pc.	AMP	TERMINALS
141TA1442	30	SCREW
141TA3612	50	SCREW

10. AUTOMATIC FUSES



For all our latest catalogue updates and company info: www.tvh.com

FUSES

THERMAL + MAGNETIC FUNCTION

RESET WITH TOGGLE SWITCH

220 VDC/660 VAC

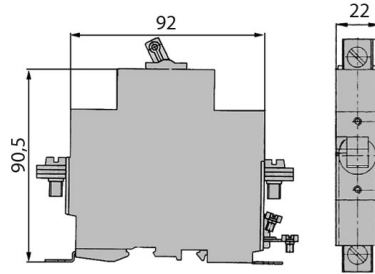
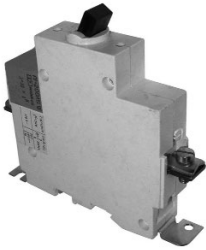

Used for: Steinbock, Jungheinrich

REF/pc.	AMP	TERMINALS
108TA4188	25	SCREW
127TA2347	40	SCREW
127TA2348	125	SCREW

250 VAC

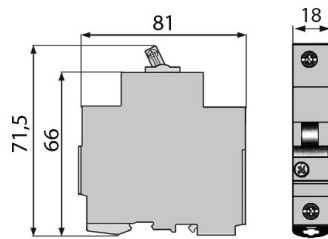

Used for: Terberg

REF/pc.	AMP	CURVE	TERMINALS
141TA1498	40	C	SCREW

400 VAC 3000

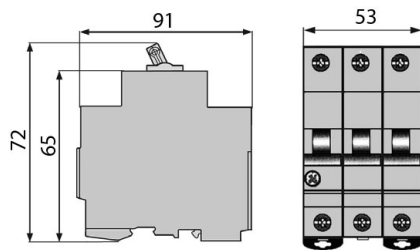

REF/pc.	AMP	CURVE	TERMINALS
141TA1511	10	C	SCREW

480 VAC 6000

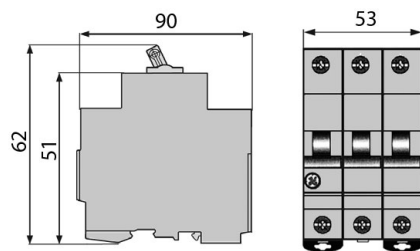

Used for: Sisu, kalmar

REF/pc.	AMP	CURVE	TERMINALS
141TA1501	32	C	SCREW
141TA1500	40	C	SCREW
141TA1499	50	C	SCREW

10. AUTOMATIC FUSES

For all our latest catalogue updates and company info: www.tvh.com

FUSES

RESET WITH PUSH BUTTON

48 VDC/415 VAC

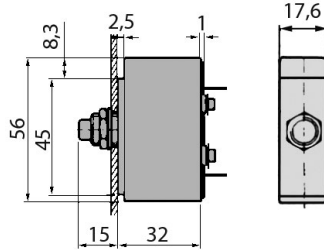
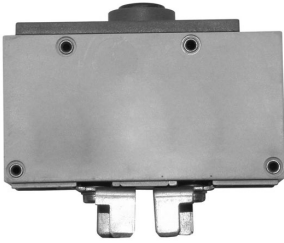

Used for: Hyster

REF/pc.	AMP	TERMINALS
141TA1525	5	BLADE
141TA1526	10	BLADE
141TA1527	15	BLADE
141TA1528	20	BLADE

100 VDC/380 VAC

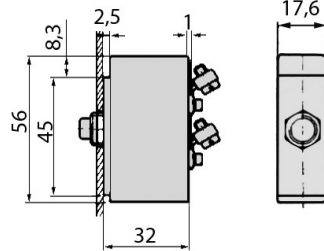

Used for: Fenwick

REF/pc.	AMP	TERMINALS
141TA4868	20	SCREW

RESET WITH TWO PUSH BUTTON

48 VDC/415 VAC

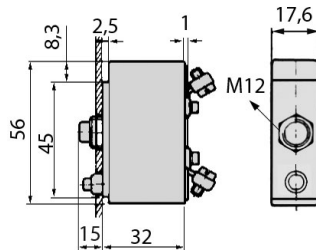

REF/pc.	AMP	TERMINALS
108TA4182	10	SCREW
119TA8954	16	SCREW
108TA4183	20	SCREW
119TA8955	25	SCREW
108TA4184	30	SCREW

100 VDC/380 VAC

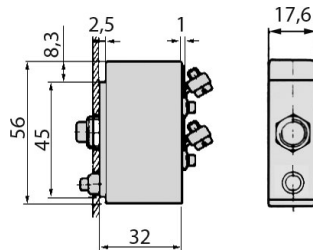

Used for: Fenwick, Lansing, Linde

REF/pc.	AMP	TERMINALS
108TA4185	6	SCREW
108TA4186	16	SCREW
108TA4187	20	SCREW

65 VDC/250 VAC

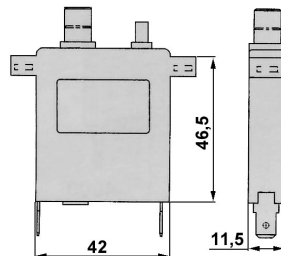
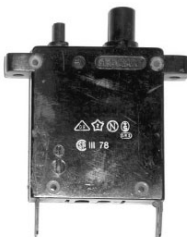

REF/pc.	AMP	TERMINALS
108TA4181	2	BLADE

FUSE HOLDERS



For all our latest catalogue updates and company info: www.tvh.com

FUSE HOLDERS

REF [106TA2740](#)

M5

For fuse type:
DIN 72582

REF [106TA2733](#)

85
27
100
25
M5 x 15

For fuse type:
DIN 72581/72582

Used for: MIC, Jungheinrich, Lafis

REF [107TA1629](#)

M5 x 15
27
73
17

For fuse type:
DIN 72581/72582

Used for: Jungheinrich

FUSE HOLDER	Connection terminal
REF 106TA2701	M8 x 20
REF 106TA2700	M10 x 20
REF 106TA2699	M10 x 30
REF 111TA3447	M8 x 20 (base 32x32)

28 32

For fuse type:
DIN 43560/43561

Fuse holder assy.:
REF [106TA2695](#)

M10

Knurled nut only
REF [111TA3448](#)

53 25 20 21 12 24 85

For fuse type:
DIN 43560/43561

FUSE HOLDER	H (mm)
REF 106TA2698	40
REF 140TA9085	50

25 20 24 12 85

M10

For fuse type:
DIN 43560/43561

Fuse holder assy.:
REF [106TA2693](#)

M10

Knurled nut only
REF [111TA3448](#)

51 25 20 21 12 24 85

For fuse type:
DIN 43560/43561

FUSES	L (mm)	REF
1	30	124TA2775
2	63	123TA8390
3	96	124TA2776

23 55 90 M10x35

For fuse type:
DIN 43560/43561

Used for: MIC, Steinbock

FUSE HOLDERS

For all our latest catalogue updates and company info: www.tvh.com

FUSE HOLDERS

FUSE HOLDER	Connection terminal	L (mm)	H (mm)
REF 111TA3449	M8 x 20	85	40
REF 106TA2694	M10 x 20	85	40
REF 119TA8956	M8 x 30	90	45
REF 119TA8957	M10 x 30	90	45

For fuse type:
DIN 43560/43561

FUSE HOLDER	Connection terminal
REF 111TA3450	M8 x 30
REF 106TA2696	M10 x 30

For fuse type:
DIN 43560/43561

FUSE HOLDER ASSY.	Connection terminal	L (mm)
REF 111TA3451	M8 x 40	135
REF 111TA3452	M10 x 40	145

Knurled nut only:
REF [111TA3454](#) (M8)
REF [111TA3448](#) (M10)

For fuse type:
DIN 43560/43561

Used for: MIC, Jungheinrich

Fuse holder assy:
REF [111TA3453](#)

For fuse type:
DIN 43560/43561

Used for: MIC, Jungheinrich

REF [140TA9090](#)

For fuse type:
CNL/ANL
+ CNN/ANN

REF [106TA2697](#)

For fuse type:
CNL/ANL
+ CNN/ANN

Used for: Hyster, Yale

REF [140TA9092](#)

For fuse type:
BF1

REF [129TA7737](#)

For fuse type:
MEGA / BF2

FUSE HOLDERS



For all our latest catalogue updates and company info: www.tvh.com

FUSE HOLDERS

REF [111TA3704](#)

Dimensions: 15, 16.2, 26, 12.2, 9, 6.5

For fuse type:
DIN 72581 / MINI

REF [106TA2730](#)

Dimensions: 25, 53, 12.5

For fuse type:
DIN 72581 / MED

REF [106TA2726](#)

Dimensions: 29, 28, 11.8, 7.6

For fuse type:
DIN 72581 / MED

Terminals: 6,3 mm

FUSES	L (mm)	REF
2	32	119TA8967
6	96	106TA2725
8	128	119TA8968

Dimensions: 44, 26, L

For fuse type:
DIN 72581 / MED

Terminals: 6,3 mm

FUSES	L (mm)	REF
4	65	127TA2668
6	85	127TA2669

Dimensions: 58, 26, L

For fuse type:
DIN 72581/MED

Terminals: 6,3 mm

FUSES	L (mm)	REF
4	80	127TA2670
6	100	127TA2671
8	120	127TA2672

Dimensions: 37, 26, L

For fuse type:
DIN 72581/MED

Terminals: 6,3 mm

REF [123TA8392](#)

Dimensions: 62, 26, 118

For fuse type:
MED/RESET/FAST

Terminals: 6,3 mm

REF [123TA8393](#)
BRIDGE for fuse holder: [DIN72581/MED](#) (L = 16 mm)

REF [129TA7566](#)
BRIDGE for fuse holder: MED/RESET/FAST (L = 11 mm)

Dimensions: L

FUSE HOLDERS

For all our latest catalogue updates and company info: www.tvh.com

FUSE HOLDERS

REF [111TA3705](#)

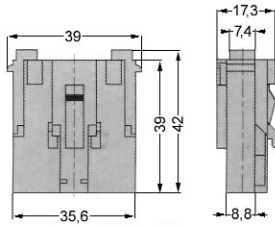
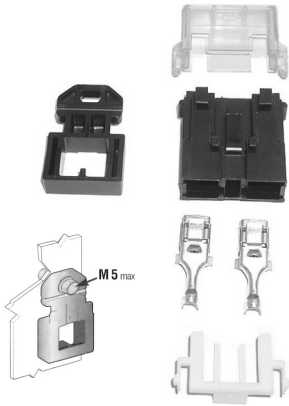

For fuse type:
DIN 72581 / MAXI



REF [106TA2734](#)

Mini/medium fuse size

REF [107TA1636](#)

Medium/maxi fuse size



EXTRACTOR
For fuse type:
DIN 72581

REF [123TA8394](#)



For fuse type:
JAPANESE/MALE



REF [123TA8395](#)



For fuse type:
VDE0636/23 NH00



REF [123TA8396](#)

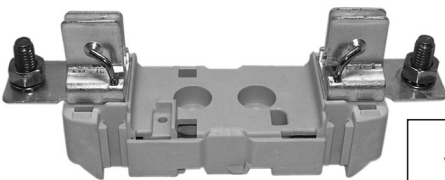

For fuse type:
VDE0636/23 NH0



REF [123TA8397](#)

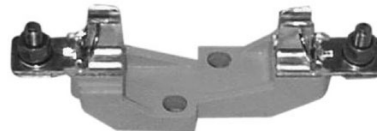

For fuse type:
VDE0636/23 NH1



REF [107TA1631](#)



cable:
33 cm

For fuse:
5 x 20 mm



REF [107TA1630](#)



Terminals: 6,3 mm

With fuse 2 A FAST:
5 x 20 mm



FUSE HOLDERS

For all our latest catalogue updates and company info: www.tvh.com

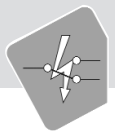

FUSE HOLDERS

REF [106TA2724](#)



Terminals: 4,8 mm

For fuse:
5 x 20 mm



REF [106TA2723](#)

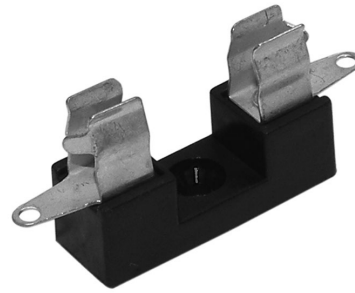

Solder terminals

For fuse:
5 x 20 mm



REF [106TA2703](#)



Solder terminals: 3 mm

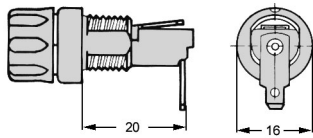

For fuse:
5 x 20 mm



REF [107TA1632](#)

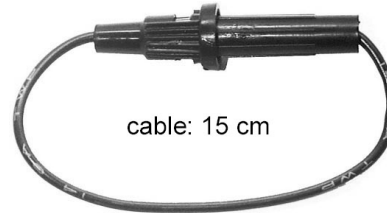

cable: 15 cm

For fuse:
6,3 x 32 mm



REF [106TA2708](#)

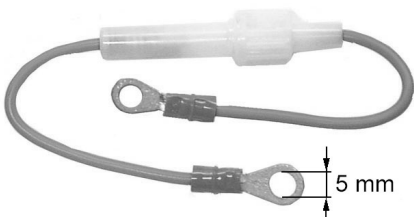

5 mm

For fuse:
6,3 x 32 mm



REF [123TA8398](#)

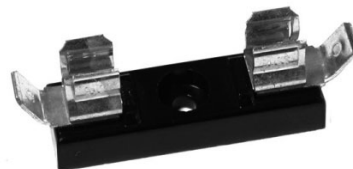

Terminals: 6,3 mm

For fuse:
6,3 x 32 mm



REF [123TA8399](#)



Solder terminals

For fuse:
6,3 x 32 mm



REF [123TA8400](#)



For fuse:
6,3 x 32 mm



FUSE HOLDERS

For all our latest catalogue updates and company info: www.tvh.com

FUSE HOLDERS

FUSES	REF
1	123TA8402
2	123TA8403
3	123TA8404
4	127TA2673
5	141TA1157

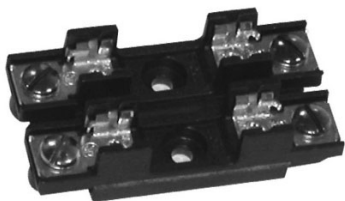

For fuse:
6,3 x 32 mm



REF [106TA2732](#)



For fuse:
6,3 x 32 mm



Used for: Hyster

REF [106TA2728](#)

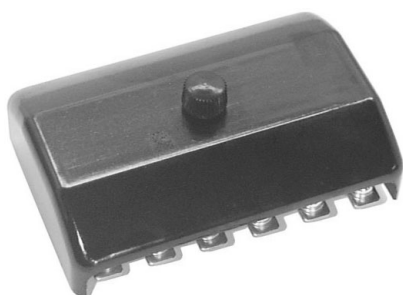

For 6 fuses:
[DIN41668](#)
6,3 x 32 mm



Used for: Nissan

Fuse holder assy:

REF [106TA2727](#)

With 3 x 10 A fuses + 1 spare
& 1 x 30 A fuse + 1 spare [DIN41668](#)

Fuse holder only:

REF [123TA8405](#)

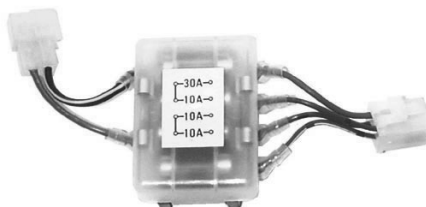

For fuse:
6,3 x 32 mm



Used for: TCM

Fuse holder assy:

REF [107TA1637](#)

With 3 x 10 A fuses + 1 spare
& 1 x 20 A fuse + 1 spare + tool [DIN41668](#)



For fuse:
6,3 x 32 mm



Used for: Toyota

REF [123TA8406](#)

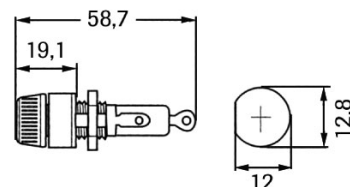

For fuse:
6,3 x 32 mm



Solder terminals

REF [106TA2722](#)

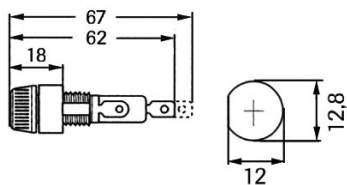

For fuse:
6,3 x 32 mm



Terminals: 6,3 mm

REF [123TA8407](#)

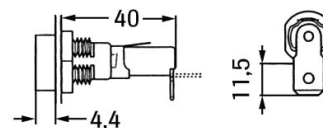

For fuse:
6,3 x 32 mm



Terminals: 6,3 mm

FUSE HOLDERS



For all our latest catalogue updates and company info: www.tvh.com

FUSE HOLDERS

REF [106TA2710](#)



Terminals: 4,8 mm

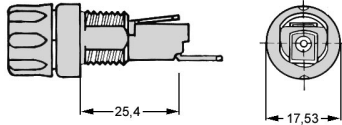

For fuse:
6,3 x 32 mm



REF [106TA2736](#)

For fuse type:
[DIN72581/1](#)

REF [106TA2738](#)

With fuse 8 A
[DIN72581/1](#)

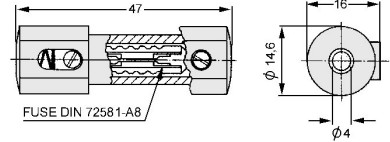

For fuse type:
[DIN72581/1](#)

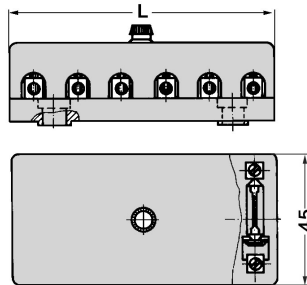

FUSES	L (mm)	Black cover REF	Transparent REF
2	45	107TA1634	119TA8958
4	60	106TA2717	119TA8959
6	90	107TA1635	119TA8960
8	120	111TA3455	106TA2719
10	151		119TA8961
12	181	106TA2721	119TA8962

With fuses:
[DIN72581/1](#) 8 A

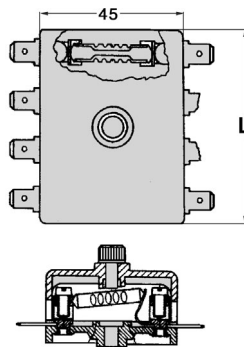
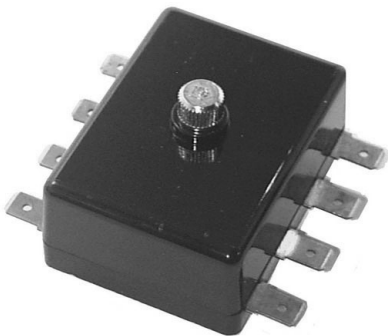

FUSES	L (mm)	Black cover REF	Transparent REF
2	45	106TA2711	119TA8963
4	60	106TA2712	119TA8964
6	90		106TA1300
8	120	106TA2714	119TA8965
12	181	107TA1633	119TA8966

With fuses:
[DIN72581/1](#) 8 A



REF [106TA2731](#)

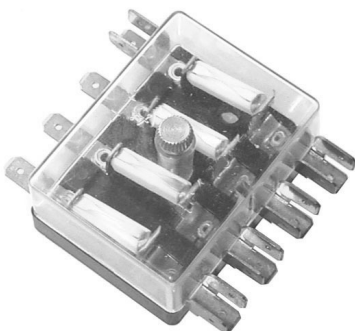

Used for: Linde

With 4 x 8 A fuses
[DIN72581/1](#)



REF [106TA2729](#)



24 terminals 6,3 mm
Used for: Fiat

For 12 fuses:
[DIN72581/1](#)



FUSE HOLDERS

For all our latest catalogue updates and company info: www.tvh.com

FUSE HOLDERS

REF [123TA8408](#)

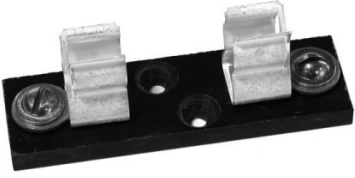

For fuse:
10 x 38 mm



Fuses	L (mm)	REF
1	22	123TA8410
2	41	123TA8411
3	60	123TA8412

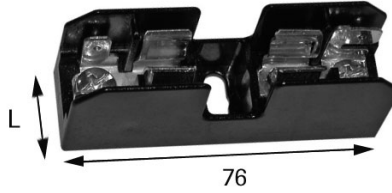

For fuse:
10 x 38 mm



Used for: Yale, Steinbock

REF [123TA8413](#)



For fuse:
10 x 38 mm



Used for: MIC, Jungheinrich

REF [127TA2674](#)

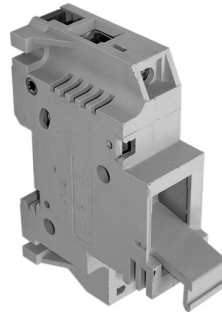

For fuse:
51 x 14 mm



Used for: MIC, Jungheinrich