

Katalog



Schütze & Kontakte



INDEX

page

PART 1: CONTACTORS

used for:

ALBRIGHT	.4
AMEISE-JUNGHEINRICH	.36
AMETEK	.38
BALKANCAR	.44
BOSCH	.45
BOSCH solenoids	.45
CABLEFORM	.52
ESSEX / WHITE-RODGERS solenoids	.47
FIAT / OM-PIMESPO	.37
GENERAL ELECTRIC	.54
HARDELLET	.59
HB	.38
HITACHI	.65
JAPANESE	.61
KISSLING solenoids	.46
KYORITSU KEIKI	.62
LANSING	.36
LINDE	.36
MEIDEN	.61
NYK-NICHIYU	.64
PRESTOLITE	.38
RAVIOLI solenoids - equivalent to BOSCH	.47
SCHALTBAU	.67
STILL	.36
TELEMECANIQUE or AMELEC	.70
TOYOTA solenoids	.49
UNELEC	.72
UNIVERSAL SMALL SIZE solenoids	.50
UNIVERSAL solenoids - equivalent to BOSCH	.48

PART 2: CONTACTS & CONTACT KITS

• Technische fiche contact contactor	.74
• Fiche technique contact de contacteur	.76
• Technical detail contact contactor	.78
• Technische Daten Relaiskontakte	.80
• Technische fiche contact kit contactor	.82
• Fiche technique kit contact de contacteur	.83
• Technical detail contact kit contactor	.84
• Technische Daten Satz Relaiskontakte	.85
• Index: contactor makes	.242
• Page index	.243
• Index: forklift truck makes	.244

• CONTACTS & CONTACT KITS used for:

- ALBRIGHT
- CABLEFORM
- GENERAL ELECTRIC
- HARDELLET
- PRESTOLITE
- AMERICAN
- SPECIAL FRENCH
- SPECIAL GERMAN
- JAPANESE
- OTHER MAKES





INDEX

page

PART 3: EMERGENCY STOPS & BUTTONS

• Technische fiche NOODSTOPSCHAKELAAR HOOG VERMOGEN208
• Fiche technique ARRET D'URGENCE HAUTE PUISSANCE211
• Technical detail EMERGENCY STOP SWITCH HIGH CAPACITY214
• Technische Daten NOTSTOPSCHALTER HOHE LEISTUNG217
• EMERGENCY STOPS used for:	
ALBRIGHT220
AMETEK226
ANDERSON226
ELEKTROSISTEM.227
HARDELLET228
KISSLING228
PRESTOLITE229
REMA229
SCHALTBAU231
• Technische fiche KNOP NOODSTOP234
• Fiche technique BOUTON D'ARRET D'URGENCE235
• Technical detail EMERGENCY STOP BUTTON236
• Technische Daten NOTSTOPTASTE237
• EMERGENCY STOP BUTTONS used for:	
ALBRIGHT238
ELEKTROSISTEM.238
HARDELLET238
KISSLING239
PRESTOLITE239
REMA239
SCHALTBAU239



TOTALSOURCE[®]

Part: 1 CONTACTORS

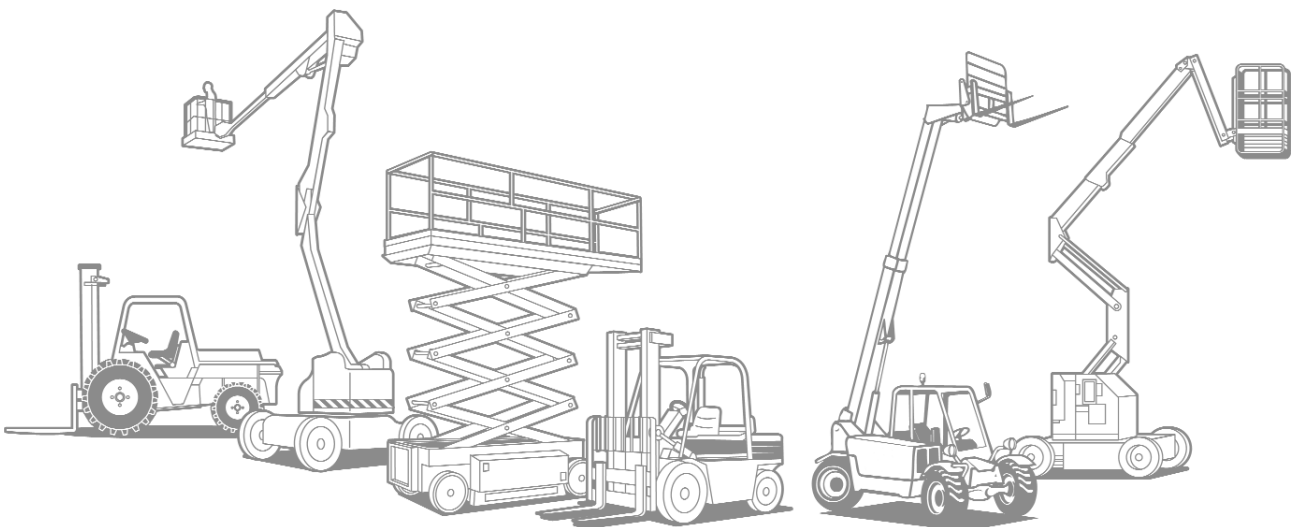



CONTACTORS

For all our latest catalogue updates and company info: www.tvh.com

used for: **ALBRIGHT - old series**

SW62/SW160 - SINGLE POLE - 100A CONTINUOUS



VOLTAGE	REMARK	CONTACTOR
12 V	INT	REF 107TA1225
16 V	CONT	REF 106TA1500
24 V	INT	REF 106TA1501
24 V	CONT	REF 106TA1502
36 V	INT	REF 106TA1503
36 V	INT	IMPREGNATED COIL
36 V	PO	90 OHMS
36 V	CONT	140 OHMS
45 V		REF 106TA1507
48 V	INT	REF 106TA1508
72 V		REF 106TA1509
80 V		REF 106TA1510
200 V	CONT	IMPREGNATED COIL
		REF 111TA3499
CONTACT KIT: REF 105TA4716		



SW117 - SINGLE POLE - WITH AUX CONTACTS - 100A CONTINUOUS



VOLTAGE	REMARK	CONTACTOR
24 V		REF 106TA1617
48 V		REF 107TA1272

SW89 - SINGLE POLE - NORMAL OPEN / REPLACED BY SW200

CONTACT KIT: REF [106TA1961](#)



SW65 - CHANGE OVER - 100A CONTINUOUS



VOLTAGE	REMARK	CONTACTOR
12 V	CONT	REF 106TA1511
24 V	INT	REF 106TA1512
48 V		REF 107TA1226
CONTACT KIT: REF 108TA8027		



used for: **ALBRIGHT - series SW60 - 80A**

SW60 - SINGLE POLE - NORMAL OPEN - 80A



VOLTAGE	REMARK	CONTACTOR
12 V		PROTECTED VERSION
12 V		REF 138TA8273
12 V		REF 138TA8274
24 V		PROTECTED VERSION
24 V		REF 138TA8275
24 V	CONT	REF 138TA8276
36 V	INT	REF 138TA8281
48 V	CONT	REF 138TA8277
65 V	INT	REF 138TA8278
80 V	CONT	REF 138TA8279
96 V		REF 138TA8280

CONTACTORS



For all our latest catalogue updates and company info: www.tvh.com

SW61 - SINGLE POLE - CHANGE OVER - 80A



VOLTAGE	REMARK	CONTACTOR
12 V		REF 138TA8269
24 V		REF 138TA8270
48 V	INT	REF 138TA8271
65 V	INT	REF 138TA8272

SW64 - PAIRED SINGLE POLE - ON/OFF CONTACTOR



VOLTAGE	REMARK	CONTACTOR
24 V	WITH AUX CONTACTS	REF 138TA8264
72 V		REF 138TA8265

SW66 - PAIRED SINGLE POLE - CHANGE OVER CONTACTOR



VOLTAGE	REMARK	CONTACTOR
24 V	CONT	REF 138TA8266
48 V	CONT	REF 138TA8267
96 V		REF 138TA8268

used for: **ALBRIGHT** - series **SU60 - 100A**

SU60 - HEAVY DUTY DC CONTACTOR - 100A



VOLTAGE	REMARK	CONTACTOR
12 V		REF 138TA8250
24 V	CONT	REF 138TA8251
48 V		REF 138TA8261

used for: **ALBRIGHT** - series **SW80 - 100A**

SW80 - SINGLE POLE - NORMAL OPEN - 100A



VOLTAGE	REMARK	CONTACTOR
12 V	INT	REF 106TA1516
12 V	CONT	REF 106TA1517
24 V	INT	REF 107TA1227
24 V	INT AUX. SWITCH	REF 111TA3501
24 V	CONT	REF 106TA1521
36 V	INT	REF 106TA1523
36 V	CONT	REF 107TA1229

CONTACT KIT: REF [103TA1545](#)



SW80B - SINGLE POLE - NORMAL OPEN - 100A



VOLTAGE	REMARK	CONTACTOR
48 V	INT	REF 107TA1236
48 V	CONT	REF 106TA1544
48 V	CONT AUX. SWITCH	REF 106TA1552
72 V	INT	REF 106TA1899
72 V	CONT	REF 107TA1239
80 V	INT	REF 107TA1243
80 V	CONT	REF 107TA1241

CONTACT KIT: REF [103TA1545](#)





CONTACTORS

For all our latest catalogue updates and company info: www.tvh.com

SW80-L - SINGLE POLE - NORMAL OPEN - 100A



VOLTAGE	REMARK	CONTACTOR
6 V	INT	REF 111TA3502
24 V	INT	REF 107TA1244
24 V	CONT	REF 107TA1246

CONTACT KIT: REF [106TA1965](#)



SW80B-L - SINGLE POLE - NORMAL OPEN - 100A



VOLTAGE	REMARK	CONTACTOR
48 V	INT SPEC. JUNGHEINRICH	REF 107TA1248
48 V	CONT	REF 107TA1249

CONTACT KIT: REF [106TA1965](#)



SW82 - DOUBLE POLE - NORMAL OPEN - 100A



VOLTAGE	REMARK	CONTACTOR
12 V	CONT	REF 106TA1566
24 V	INT	REF 107TA1255
48 V	INT	REF 107TA1256
48 V	CONT	REF 106TA1570
72 V	CONT	REF 106TA1571

CONTACT KIT: REF [106TA1966](#)



SW82-L - DOUBLE POLE - NORMAL OPEN - 100A



VOLTAGE	REMARK	CONTACTOR
24 V	INT	REF 106TA1573
24 V	CONT	REF 107TA1258

CONTACT KIT: REF [110TA3621](#)



SW84 - SINGLE POLE - CHANGE OVER - 100A



VOLTAGE	REMARK	CONTACTOR
12 V	INT	REF 107TA1263
12 V	CONT	REF 106TA1584
24 V	INT	REF 105TA4805
24 V	CONT	REF 106TA1585
48 V	INT	REF 106TA1586
48 V	CONT	REF 107TA1264
48 V	CONT AUX. SWITCH	REF 107TA1265

CONTACT KIT: REF [106TA1970](#)



SW84B - SINGLE POLE - CHANGE OVER - 100A



VOLTAGE	REMARK	CONTACTOR
72 V	CONT	REF 106TA1589

CONTACT KIT: REF [106TA1970](#)



CONTACTORS



For all our latest catalogue updates and company info: www.tvh.com

SW822 - DOUBLE POLE - FOR MOTOR REVERSING - 100A



VOLTAGE	REMARK	CONTACTOR
24 V	INT	REF 106TA1576
24 V	CONT	REF 107TA1260
CONTACT KIT: REF 110TA3563		

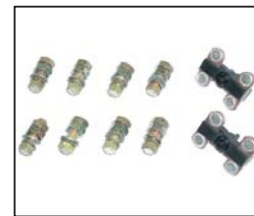

SW822-L - DOUBLE POLE - FOR MOTOR REVERSING - 100A



VOLTAGE	REMARK	CONTACTOR
24 V	INT	REF 107TA1261
24 V	CONT	REF 106TA1581
CONTACT KIT: REF 107TA1437		



SW88 - CHANGE OVER - FOR MOTOR REVERSING - 100A



VOLTAGE	REMARK	CONTACTOR
12 V	INT	REF 106TA1590
24 V	INT	REF 107TA1266
24 V	CONT	REF 106TA1842
36 V	INT	REF 106TA1592
48 V	INT	REF 106TA1594
48 V	CONT	REF 107TA1393
72 V	INT	REF 111TA3503
80 V	INT	REF 106TA1595
CONTACT KIT: REF 108TA7783		



DC88 - CHANGE OVER - MONOBLOC FOR MOTOR REVERSING - 100A

(This list shows only standard cover configurations)



VOLTAGE	REMARK	CONTACTOR
12 V	INT	REF 107TA1346
24 V	INT	REF 106TA1799
CONTACT KIT: REF 110TA3639		

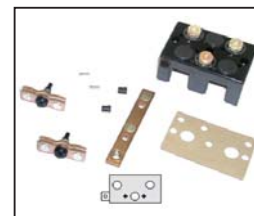

DC88B - CHANGE OVER - MONOBLOC FOR MOTOR REVERSING - 100A

(This list shows only standard cover configurations)



VOLTAGE	REMARK	CONTACTOR
36 V	CONT	REF 111TA3504
48 V	INT	REF 107TA1353
CONTACT KIT: REF 107TA1466		

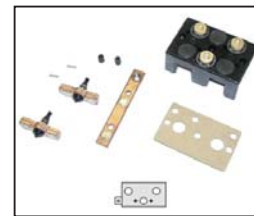

DC88-T - CHANGE OVER - MONOBLOC FOR MOTOR REVERSING - 100A

(This list shows only standard cover configurations)



VOLTAGE	REMARK	CONTACTOR
24 V	INT	DUST COVERS REF 107TA1349
CONTACT KIT: REF 107TA1464		

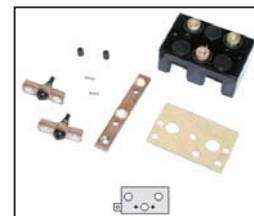



CONTACTORS

For all our latest catalogue updates and company info: www.tvh.com

DC88B-T - CHANGE OVER - MONOBLOC FOR MOTOR REVERSING - 100A

(This list shows only standard cover configurations)



VOLTAGE	REMARK	CONTACTOR
24 V	INT SPECIAL NYK-NICHIYU	REF 111TA3505
48 V	INT DUST COVERS	REF 107TA1354
48 V	INT SPECIAL NYK-NICHIYU	REF 111TA3506

DC92-L - SINGLE POLE - MONOBLOC - 100A

(This list shows only standard cover configurations)



VOLTAGE	REMARK	CONTACTOR
12 V	CONT	REF 111TA3507
24 V	CONT	REF 107TA1355

used for: **ALBRIGHT** - series SW100 - 125A

SW100 - SINGLE POLE - NORMAL OPEN - 125A



VOLTAGE	REMARK	CONTACTOR
24 V	INT	REF 106TA1604
48 V	INT	REF 106TA1605
110 V	CONT	REF 106TA1606

CONTACT KIT: REF [106TA1975](#)



SW100B - SINGLE POLE - NORMAL OPEN - 125A



VOLTAGE	REMARK	CONTACTOR
24 V	INT	REF 107TA1271
48 V	INT	REF 106TA1605
48 V	CONT	REF 106TA1608
72/80 V	INT	REF 106TA1609

CONTACT KIT: REF [106TA1975](#)



SW120 - DOUBLE POLE - NORMAL OPEN - 125A



VOLTAGE	REMARK	CONTACTOR
12 V		REF 107TA1273
24 V		REF 106TA1622
36 V		REF 107TA1274
48 V		REF 122TA7493

CONTACT KIT: REF [110TA3613](#)



SW101B - CHANGE OVER - 125A



VOLTAGE	REMARK	CONTACTOR
24 V	CONT	REF 106TA1610

CONTACT KIT: REF [106TA1976](#)

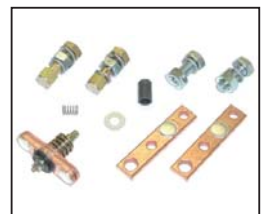

CONTACTORS



For all our latest catalogue updates and company info: www.tvh.com

SW102 - FOR MOTOR REVERSING - CHANGE OVER - 125A



VOLTAGE	REMARK	CONTACTOR
12 V	INT	REF 106TA1611
CONTACT KIT: REF 108TA8120		

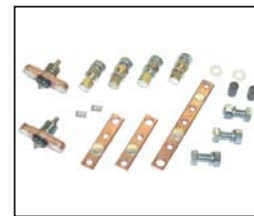

SW102B - FOR MOTOR REVERSING - CHANGE OVER - 125A



VOLTAGE	REMARK	CONTACTOR
24 V	INT	REF 106TA1613
48 V	INT	REF 106TA1614
80 V	INT DOUBLE L-BRACKET	REF 106TA1615
CONTACT KIT: REF 108TA8120		

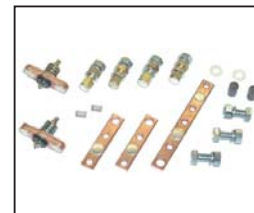

used for: **ALBRIGHT** - series SW180 - 150A

SW180 - SINGLE POLE - NORMAL OPEN - 150A



VOLTAGE	REMARK	CONTACTOR
12 V	INT	REF 107TA1278
24 V	INT	REF 106TA1631
24 V	CONT	REF 107TA1281
36 V	INT	REF 106TA1635
36 V	CONT	REF 107TA1282
48 V	INT	REF 106TA1637
48 V	CONT	REF 106TA1638
CONTACT KIT: REF 108TA8231		



SW180B - SINGLE POLE - NORMAL OPEN - 150A



VOLTAGE	REMARK	CONTACTOR
12 V	CONT	REF 106TA1644
24 V	INT	REF 106TA1645
24 V	CONT	REF 106TA1647
36 V	INT	REF 111TA3509
48 V	INT	REF 106TA1648
48 V	CONT	REF 106TA1651
72/80 V	INT	REF 106TA1653
72/80 V	CONT	REF 106TA1655
CONTACT KIT: REF 108TA8231		



SW180-L - SINGLE POLE - NORMAL OPEN - 150A



VOLTAGE	REMARK	CONTACTOR
24 V	INT	REF 106TA1640
24 V	CONT	REF 106TA1643
CONTACT KIT: REF 110TA3638		



SW180B-L - SINGLE POLE - NORMAL OPEN - 150A



VOLTAGE	REMARK	CONTACTOR
48 V	INT	REF 106TA1659
48 V	CONT	REF 106TA1660
48 V	CONT AUX. SWITCH	REF 107TA1287
CONTACT KIT: REF 110TA3638		





CONTACTORS

For all our latest catalogue updates and company info: www.tvh.com

SW185 - SINGLE POLE - NORMAL CLOSED - 150A



VOLTAGE	REMARK	CONTACTOR
48 V		REF 106TA1714
CONTACT KIT: REF 110TA3590		



SW190 - DOUBLE POLE - NORMAL OPEN - 150A



VOLTAGE	REMARK	CONTACTOR
24 V	CONT	REF 111TA3510
CONTACT KIT: REF 107TA1444		



SW190B - DOUBLE POLE - NORMAL OPEN - 150A



VOLTAGE	REMARK	CONTACTOR
24 V	INT	REF 111TA3511
48 V	CONT	REF 111TA3512
CONTACT KIT: REF 107TA1444		



SW181 - CHANGE OVER - 150A



VOLTAGE	REMARK	CONTACTOR
24 V	INT	REF 106TA1663
36 V	CONT	REF 106TA1664
48 V	INT	REF 106TA1665
48 V	CONT	REF 106TA1885
CONTACT KIT: REF 107TA1441		

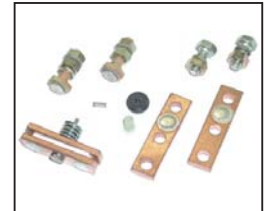

SW181B - CHANGE OVER - 150A



VOLTAGE	REMARK	CONTACTOR
12 V	INT	REF 106TA1667
24 V	INT	REF 106TA1668
24 V	CONT	REF 106TA1670
36 V	INT	REF 107TA1289
36/48 V	CONT	REF 111TA3513
48 V	INT	REF 106TA1672
48 V	PO	REF 107TA1291
48 V	PO	DUST COVERS REF 106TA1675
80 V	INT	AUX. SWITCH REF 106TA1666
80 V	PO	DUST COVERS REF 107TA1292
80 V	CONT	REF 106TA1677
CONTACT KIT: REF 107TA1441		



SW181B-T - CHANGE OVER - 150A



VOLTAGE	REMARK	CONTACTOR
24 V	INT	REF 107TA1293
24 V	PO	DUST COVERS REF 107TA1294
48 V	PO	REF 111TA3514
48 V	PO	DUST COVERS REF 107TA1295
80 V	PO	REF 111TA3515
CONTACT KIT: REF 107TA1442		



CONTACTORS



For all our latest catalogue updates and company info: www.tvh.com

SW192 - FOR MOTOR REVERSING - DOUBLE POLE - 150A



VOLTAGE	REMARK	CONTACTOR
24 V	INT NO	REF 135TA3231
CONTACT KIT: REF 106TA1986		

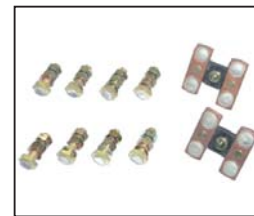

SW192B - FOR MOTOR REVERSING - DOUBLE POLE - 150A



VOLTAGE	REMARK	CONTACTOR
36/48 V	INT NO	REF 107TA1316
48 V	INT STD	REF 111TA3517
72/80 V	INT NO	REF 106TA1720
CONTACT KIT: REF 106TA1986		

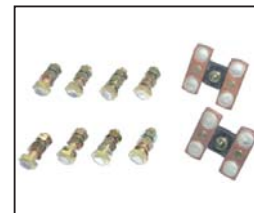

SW192-L - FOR MOTOR REVERSING - DOUBLE POLE - 150A



VOLTAGE	REMARK	CONTACTOR
60 V	CONT STD	REF 111TA3518
80 V	CONT STD	REF 107TA1315
CONTACT KIT: REF 106TA1987		

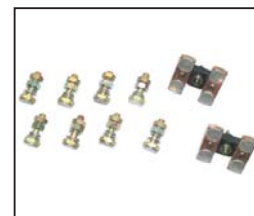

SW182 - FOR MOTOR REVERSING - CHANGE OVER - 150A



VOLTAGE	REMARK	CONTACTOR
12 V	INT	REF 107TA1296
24 V	INT	REF 107TA1297
24 V	INT AUX. SWITCH	REF 106TA1713
24 V	CONT	REF 107TA1300
36 V	INT	REF 107TA1301
CONTACT KIT: REF 110TA3573		



SW182B - FOR MOTOR REVERSING - CHANGE OVER - 150A



VOLTAGE	REMARK	CONTACTOR
48 V	INT	REF 106TA1696
48 V	CONT	REF 107TA1308
72/80 V	INT	REF 111TA3519
72/80 V	PO	REF 107TA1310
CONTACT KIT: REF 110TA3573		



SW182B-L - FOR MOTOR REVERSING - CHANGE OVER - 150A



VOLTAGE	REMARK	CONTACTOR
48 V	CONT	REF 106TA1711
72/80 V	INT DOUBLE L-BRACKET	REF 106TA1712
CONTACT KIT: REF 108TA8087		



DC182 - CHANGE OVER - MONOBLOC FOR MOTOR REVERSING - 150A

(This list shows only standard cover configurations)



VOLTAGE	REMARK	CONTACTOR
12 V	INT	REF 111TA3520
24 V	INT	REF 106TA1812
24 V	CONT DUST COVERS	REF 107TA1359
CONTACT KIT: REF 110TA3635		

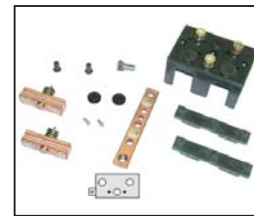

O.E.M. references are purely indicative and do not imply that parts originate from the original manufacturer.



CONTACTORS

For all our latest catalogue updates and company info: www.tvh.com

DC182B - FOR MOTOR REVERSING - CHANGE OVER - 150A

(This list shows only standard cover configurations)



VOLTAGE	REMARK	CONTACTOR
24 V	INT	REF 106TA1818
36 V	INT	REF 106TA1819
48 V	INT	REF 107TA1363
80 V	INT	REF 106TA1829
72/80 V	INT	REF 106TA1830
CONTACT KIT: REF 108TA7881		

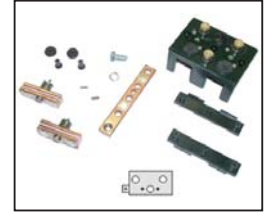

DC182-L - CHANGE OVER - MONOBLOC FOR MOTOR REVERSING - 150A

(This list shows only standard cover configurations)



VOLTAGE	REMARK	CONTACTOR
24 V	INT SUPPRESSION	REF 106TA1817
CONTACT KIT: REF 110TA3627		

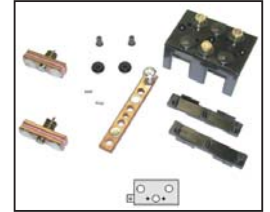

DC182B-T - CHANGE OVER - MONOBLOC FOR MOTOR REVERSING - 150A

(This list shows only standard cover configurations)



VOLTAGE	REMARK	CONTACTOR
24 V	INT	REF 107TA1364
48 V	INT	REF 111TA3521
CONTACT KIT: REF 110TA3605		

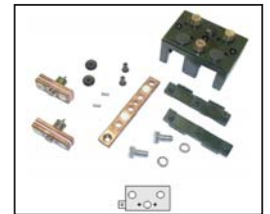

DC182EE - CHANGE OVER - MONOBLOC FOR MOTOR REVERSING - 150A

(This list shows only standard cover configurations)



VOLTAGE	REMARK	CONTACTOR
24 V	INT SPECIAL PROTECTED	REF 111TA3522



DC184B - SINGLE POLE - MONOBLOC - 150A



VOLTAGE	REMARK	CONTACTOR
48 V	INT SUPPRESSION	REF 106TA1836
80 V	INT SUPPRESSION	REF 107TA1369
CONTACT KIT: REF 107TA1451		



CONTACTORS



For all our latest catalogue updates and company info: www.tvh.com

used for: **ALBRIGHT - series SW200 - 250A**

SW200 - SINGLE POLE - NORMAL OPEN - 250A



VOLTAGE	REMARK	CONTACTOR
12 V	CONT	REF 106TA1721
24 V	INT	REF 107TA1317
24 V	CONT	REF 106TA1723
24 V	CONT AUX. SWITCH	REF 107TA1331
36 V	INT	REF 106TA1724
36 V	INT AUX. SWITCH	REF 106TA1751
36/48 V	CONT	REF 111TA3523
48 V	INT	REF 106TA1727
48 V	INT AUX. SWITCH	REF 106TA1752
48 V	CONT	REF 107TA1320
72 V	INT	REF 106TA1734
72 V	INT AUX. SWITCH	REF 106TA1753
72 V	CONT	REF 106TA1919
72/80 V	INT AUX. SWITCH	REF 106TA1754
72/80 V	PO AUX. SWITCH	REF 107TA1332
80 V	INT	REF 107TA1324
80 V	CONT	REF 107TA1327
96 V	CONT CLOSED COVER	REF 107TA1329

CONTACT KIT: REF [110TA3633](#)



SW200N - SINGLE POLE - NORMAL OPEN - 250A



VOLTAGE	REMARK	CONTACTOR
12 V	INT	REF 107TA1333
24 V	INT	REF 106TA1759
24 V	CONT	REF 111TA3524

CONTACT KIT: REF [110TA3633](#)



SW210 - SINGLE POLE - NORMAL CLOSED - 250A



VOLTAGE	REMARK	CONTACTOR
48 V	INT	REF 107TA1342
80 V	INT	REF 106TA1791

CONTACT KIT: REF [107TA1446](#)



SW201 - SINGLE POLE - CHANGE OVER - 250A



VOLTAGE	REMARK	CONTACTOR
24 V	INT	REF 107TA1334
24 V	CONT	REF 107TA1335
36 V	INT	REF 106TA1765
36/48 V	PO CLOSED COVER	REF 111TA3525
48 V	INT	REF 107TA1337
48 V	CONT	REF 107TA1400
80 V	INT	REF 106TA1768
80 V	PO	REF 106TA1769

CONTACT KIT: REF [106TA1988](#)



SW201N - SINGLE POLE - CHANGE OVER - 250A



VOLTAGE	REMARK	CONTACTOR
48 V	PO L-BRACKET	REF 106TA1770
48 V	PO	REF 107TA1338

CONTACT KIT: REF [106TA1988](#)





CONTACTORS

For all our latest catalogue updates and company info: www.tvh.com

SW201-T - SINGLE POLE - CHANGE OVER - 250A



VOLTAGE	REMARK	CONTACTOR
36 V	PO CLOSED COVER	REF 111TA3526
80 V	PO	REF 111TA3527

CONTACT KIT: REF [107TA1445](#)



SW202 - FOR MOTOR REVERSING - CHANGE OVER - 250A



VOLTAGE	REMARK	CONTACTOR
24 V	INT	REF 105TA4803
36 V	INT	REF 106TA1773
48 V	INT	REF 106TA1774
48 V	CONT	REF 106TA1777
72 V	INT	REF 106TA1778
72/80 V	CONT	REF 106TA1779
80 V	INT	REF 106TA1782

CONTACT KIT: REF [110TA3637](#)



SW202N - FOR MOTOR REVERSING - CHANGE OVER - 250A



VOLTAGE	REMARK	CONTACTOR
24 V	INT	REF 107TA1340

CONTACT KIT: REF [110TA3637](#)

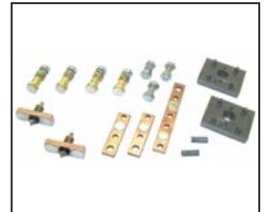



For all our latest catalogue updates and company info: www.tvh.com

used for: **ALBRIGHT - series SW500 - 500A**

SW500 - SINGLE POLE - NORMAL OPEN - 500A



VOLTAGE	REMARK	CONTACTOR
12 V		REF 138TA8262
30 V	CONT WITH AUX CONTACT	REF 138TA8248
60 V	CONT WITH AUX CONTACT	REF 138TA8247
80 V		REF 138TA8263

EXPLANATION ALBRIGHT CODES



code	REMARK
A	with Auxiliary switch
B	with Blow-outs (blow-outs are standard fitted on SW200)
T	Textured contact tips
L	with Large contacts
P	environmentally Protected
INT	coil for intermittent use (max.70%)
PO	coil for prolonged operation
CONT	coil for continuous operation

BRACKETS USED FOR ALBRIGHT CONTACTORS

	TYPE	REF
┌	Single bracket	SW 80 107TA1448
		SW 100/180 107TA1449
		SW 200 106TA1995
└	L-bracket	SW 80 107TA1450
		SW 100/180/200 106TA1997
┌└	Double bracket	SW 88, DC88, SW822 106TA1998
		SW 102/182, DC 182 106TA1999
		SW 202 106TA2000
┌└	Bracket pair	SW 80 107TA9696
		SW 100/180/200 106TA2001

On the following pages you can find a complete list of all the ALBRIGHT references known in our system.

Also other types can be supplied, if your requested part number is not mentioned in the list, please do not hesitate to ask.



CONTACTORS

For all our latest catalogue updates and company info: www.tvh.com

used for: **ALBRIGHT**

TYPE	VOLTAGE	COIL TYPE	TYPE	VOLTAGE	COIL TYPE
DC182-1	12V	INT	DC182B-403		
DC182-102	24V	INT	DC182B-40L		
DC182-116			DC182B-410D	48V	INT
DC182-148	24V	PO	DC182B-413		
DC182-180L	12V		DC182B-420		
DC182-181L	24V	INT	DC182B-426	72V	INT
DC182-207	24V		DC182B-428	36V/48V	
DC182-235	48V		DC182B-429	72V	PO
DC182-237	12V	INT	DC182B-432	80V	INT
DC182-24			DC182B-434		
DC182-248			DC182B-447		
DC182-24L			DC182B-450T		
DC182-254	48V	INT	DC182B-470	36V/48V	
DC182-2P			DC182B-474	48V	PO
DC182-36	36V		DC182B-48		
DC182-4	24V	CONT	DC182B-495	48V	PO
DC182-403	24V	INT	DC182B-499	80V	INT
DC182-406	24V	INT	DC182B-4L	24V	CONT
DC182-408	24V	INT	DC182B-508	24V	INT
DC182-411	80V	INT	DC182B-513L	48V	
DC182-416	24V		DC182B-515		
DC182-419	48V		DC182B-518T	72V/80V	
DC182-48	24V	CONT	DC182B-521	48V	INT
DC182B-103	48V	INT	DC182B-535T	24V	INT
DC182-5	36V	INT	DC182B-537T		
DC182-503	24V		DC182B-542T		
DC182-533	48V		DC182B-543	24V	CONT
DC182-537T			DC182B-544	36V	CONT
DC182-559T	24V		DC182B-545	48V	CONT
DC182-589	80V		DC182B-546	72V	CONT
DC182-590T	24V		DC182B-547	80V	CONT
DC182-6	36V	CONT	DC182B-556T		
DC182-611	24V	INT	DC182B-557T		
DC182-617T			DC182B-581T	80V	INT
DC182-627L			DC182B-586	48V	INT
DC182-628	24V	INT	DC182B-588		
DC182-635			DC182B-602	24V	
DC182-637	24V		DC182B-604	72V/80V	
DC182-646			DC182B-612T		
DC182-690			DC182B-615T	48V	INT
DC182-693	24V	INT	DC182B-643	48V	
DC182-698	80V		DC182B-648T		
DC182-8	48V	CONT	DC182B-655	24V	
DC182-80			DC182B-693	24V	
DC182A-51			DC182B-698		
DC182B-1	12V	INT	DC182B-7	48V	INT
DC182B-10			DC182B-710L	24V	
DC182B-11	72V	INT	DC182B-719L	24V	
DC182B-148			DC182B-80	80V	
DC182B-15	72V/80V		DC182EE-454	24V	
DC182B-202			DC182EE-468	24V	
DC182B-206	24V	INT	DC182EE-665	12V	
DC182B-235	48V	INT	DC182EE-681		
DC182B-247	24V	INT	DC182EE-B488L		
DC182B-252	24V	INT	DC184-417L	24V	
DC182B-256	72V	INT	DC184-421		
DC182B-3	24V	INT	DC184-422	24V	
DC182B-361			DC184-423L	24V	INT

O.E.M. references are purely indicative and do not imply that parts originate from the original manufacturer.

CONTACTORS



For all our latest catalogue updates and company info: www.tvh.com

used for: **ALBRIGHT**

TYPE	VOLTAGE	COIL TYPE	TYPE	VOLTAGE	COIL TYPE
DC184AB-429L	48V	CONT	DC88-6		
DC184AB-L429			DC88-643		
DC184B-101	48V		DC88-7	48V	
DC184B-426			DC88A-15		
DC66-14P	24V		DC88A-238	21/14V	
DC66-19P	12V		DC88A-24	72V	
DC66-33P833			DC88A-370	24V	
DC66-9P	12V		DC88B-1	24V	
DC88-1	24V	INT	DC88B-111	24V	INT
DC88-103	24V	INT	DC88B-116	24V	
DC88-111	24V	INT	DC88B-119	24V	INT
DC88-116	24V	INT	DC88B-122	48V	INT
DC88-119	24V		DC88B-123	36V	INT
DC88-128	24V	INT	DC88B-129	36V	
DC88-129	36V	INT	DC88B-137	24V	
DC88-130	48V	INT	DC88B-147	72V	INT
DC88-136	12V	INT	DC88B-148	80V	INT
DC88-166			DC88B-233	36V	
DC88-211E			DC88B-257	48V	
DC88-216E			DC88B-284		
DC88-217E	24V	CONT	DC88B-284T	48V	
DC88-220E	24V		DC88B-30		
DC88-221E	24V		DC88B-314T		
DC88-222E	12V		DC88B-317T	13/3V	
DC88-234	12V	INT	DC88B-325T	48V	INT
DC88-24			DC88B-326	48V	
DC88-241	24V	PO	DC88B-331	24V	INT
DC88-246	12V	INT	DC88B-334	72V	INT
DC88-247E	24V		DC88B-360T	48V	INT
DC88-252	24V		DC88B-398	72V	INT
DC88-259			DC88B-417L	36V	CONT
DC88-264	36V		DC88B-4	24V	
DC88-266			DC88B-456L	36V	CONT
DC88-267L			DC88B-467L	12V	
DC88-276P			DC88B-501	24V	
DC88-286L	12V	INT	DC88B-51	80V	
DC88-295P	36V		DC88B-8	48V	
DC88-303	24V		DC88B-80		
DC88-309T	12V		DC88B-91	12V	INT
DC88-314T	14/5V	INT	DC88E-244	24V	
DC88-323T	24V		DC88E-252	24V	CONT
DC88-339PE			DC88E-271	24V	CONT
DC88-355T	24V		DC88E-383	36V	CONT
DC88-368L	24V	INT	DC88EE-239	12V	
DC88-369E	24V		DC88EE-243	24V	
DC88-379T	36V	CONT	DC88EE-262	24V	
DC88-382T	12V	INT	DC88EE-337	24V	
DC88-394PL	12V		DC88L-142		
DC88-396E	24V		DC88L-227	36V	
DC88-398	72V	CONT	DC88L-283	12V	
DC88-399	24V		DC88P-279	12V	CONT
DC88-4	24V	CONT	DC88P-285	36V	CONT
DC88-408			DC88P-292	36V	CONT
DC88-409T	24V		DC88PL-389	24V	CONT
DC88-436PE	24V		DC8EE-249	24V	
DC88-437T	24V		DC92-1	24V	INT
DC88-468	24V		DC92-212E	24V	
DC88-5	36V		DC92-223L	24V	

O.E.M. references are purely indicative and do not imply that parts originate from the original manufacturer.



CONTACTORS

For all our latest catalogue updates and company info: www.tvh.com

used for: **ALBRIGHT**

TYPE	VOLTAGE	COIL TYPE	TYPE	VOLTAGE	COIL TYPE
DC92-225L	12V		SW102-36		
DC92-233L			SW102-3648	36/48V	
DC92-AL222	24V	CONT	SW102-4		
DC92B-224	48V	CONT	SW102-419		
DC92B-249	48V		SW102-48	72/80V	INT
DC92P-234	36V	CONT	SW102-6	48V	INT
SW100-124	36V		SW102-88	12V	INT
SW100-129	24V	CONT	SW102A-36	48V	INT
SW100-140	36V	CONT	SW102AB-25	24V	INT
SW100-152	24V		SW102B-111	40V	
SW100-16	72V	INT	SW102B-12		
SW100-163	230V		SW102B-2	12V	CONT
SW100-19			SW102B-32	48V	
SW100-20	48V		SW102B-45		
SW100-23	24V	INT	SW102B-46	36/48V	
SW100-24	24V	INT	SW102B-53	72V	
SW100-25	12V	INT	SW102B-54	72V	
SW100-3	24V	CONT	SW102B-55	24V	
SW100-36	36V		SW102B-80	80V	INT
SW100-5	36V		SW105A-24		
SW100-59	40		SW106-7		
SW100-62	120V	INT	SW106A-1		
SW100-74	36/48V	INT	SW106A-1M		
SW100-75	72/80V		SW106A-22M	36V	
SW100-79			SW106B-222	24V	INT
SW100-8			SW106B-378	48V	INT
SW100A-11	24V		SW110-9		
SW100A-58	48V	CONT	SW112-2	12V	
SW100AB-136	24V	INT	SW112-25	80V	
SW100AB-16	72V	INT	SW112-36	24V	
SW100AB-5	36V	INT	SW112-9	36V	
SW100AB-7	48V	INT	SW112A-17	12V	
SW100B-116	72V	INT	SW112A-19	32V	
SW100B-124			SW117-124	24V	
SW100B-19	72/80V	CONT	SW117-16		
SW100B-2	12V	CONT	SW117-4	48V	INT
SW100B-22	48V		SW117-5		
SW100B-26	80V	INT	SW118-8	48V	
SW100B-3	24V	CONT	SW118-9	36V	
SW100B-45	72/80V	INT	SW120-11	72V	CONT
SW100B-5	36V	INT	SW120-124		
SW100B-62	120V	INT	SW120-2	24V	
SW100B-72			SW120-27	28V	CONT
SW100B-74	48V	INT	SW120-36	36V	
SW100B-76	120V		SW120-4	24V	
SW100B-81			SW120-48	48V	
SW101-1	24V		SW120-7	48V	INT
SW101-2	12V		SW120-8	48V	CONT
SW101-22	48V		SW120A-29	12V	CONT
SW101-58			SW120A-31	24V	
SW101A-32	48V	CONT	SW120A-32	36V	INT
SW101B-1	24V	INT	SW120A-34	48V	
SW102-1	24V		SW120A-35	48V	
SW102-114	24V		SW120A-44	125V	
SW102-12	12V	INT	SW120A-48	48V	
SW102-13			SW120A-62	110V	CONT
SW102-19	24V	INT	SW120A-64	120V	CONT
SW102-27	36V	CONT	SW120A-91	110V	

O.E.M. references are purely indicative and do not imply that parts originate from the original manufacturer.

CONTACTORS



For all our latest catalogue updates and company info: www.tvh.com

used for: **ALBRIGHT**

TYPE	VOLTAGE	COIL TYPE	TYPE	VOLTAGE	COIL TYPE
SW120AB-36			SW160-12	48V	
SW121-1	12V	INT	SW160-14	24V	INT
SW121-10	60V	CONT	SW160-2		
SW121-111	120V	CONT	SW160-4		
SW121-12			SW161-1	24V	
SW121-2	12V	CONT	SW163-2	24V	
SW121-20	110V	CONT	SW163-3	12V	
SW121-3	24V	INT	SW180-521	24V	CONT
SW121-4	24V	CONT	SW180-0081		
SW121-78	12V	CONT	SW180-04	24V	CONT
SW121-8	48V	CONT	SW180-10	60V	CONT
SW121-80	48V	CONT	SW180-103L		
SW121-81	120V	CONT	SW180-106S	24V	INT
SW121-94	48V	CONT	SW180-108	24V	
SW121A-116			SW180-11	72V	INT
SW121A-121	28V	CONT	SW180-12	72V	CONT
SW121A-44	12V		SW180-123	144V	CONT
SW121A-50	48V		SW180-129	24V	CONT
SW121A-51	48V		SW180-13	80V	INT
SW121A-65	120V		SW180-130L	24V	
SW122-19L	24V		SW180-134	24V	INT
SW122-3	80V		SW180-137		
SW122-8	48V	CONT	SW180-139	12V	
SW125-41	48V	CONT	SW180-14	80V	CONT
SW125A-1			SW180-140	24V	CONT
SW125A-1M	18V		SW180-144	12V	CONT
SW125A-2			SW180-148	24V	
SW125A-59	120V	CONT	SW180-15		
SW126-6			SW180-152	12V	PO
SW128-47	72V	INT	SW180-16		
SW128-5	12V	INT	SW180-164L	48V	
SW128-54M	24V		SW180-19	110V	
SW128-9	48V		SW180-195		
SW129-2M	12V	INT	SW180-196	24V	CONT
SW12BA-2	80V		SW180-2	12V	CONT
SW130-13	24V		SW180-20	110V	CONT
SW130A-11	24V	CONT	SW180-201	28V	
SW130A-26	12V	CONT	SW180-21	120V	
SW132-20	110V	CONT	SW180-215L	24V	INT
SW132-4	24V	CONT	SW180-22	24V	INT
SW132-8	48V	CONT	SW180-224	48V	INT
SW132E-23	24V	CONT	SW180-226	72/80V	
SW135-1	48V		SW180-235	72V	
SW150-01	30V		SW180-261		
SW150-0A			SW180-267L		
SW150-0A31	110V		SW180-271		
SW150-0A38	120V	CONT	SW180-279		
SW150-0A4	60V		SW180-27L	36V	
SW152-1M	12V		SW180-280	12V	
SW155-1L			SW180-282	24V	
SW155-3			SW180-283	24V	
SW155-6			SW180-284	60V	
SW155-7			SW180-29L	48V	PO
SW155L-3			SW180-303	36V	CONT
SW158-1	24V		SW180-309L		
SW159-3			SW180-30L		
SW159L-1			SW180-313L		
SW160-10			SW180-332	36V	

O.E.M. references are purely indicative and do not imply that parts originate from the original manufacturer.



CONTACTORS

For all our latest catalogue updates and company info: www.tvh.com

used for: **ALBRIGHT**

TYPE	VOLTAGE	COIL TYPE	TYPE	VOLTAGE	COIL TYPE
SW180-334			SW180A-46	12V	CONT
SW180-33L	72V		SW180A-47	24V	INT
SW180-349	24V		SW180A-474	54V	CONT
SW180-352	24V	INT	SW180A-49	36V	INT
SW180-36	36/48V		SW180A-499L	24V	
SW180-3648	36/48V		SW180A-50	36V	CONT
SW180-37L			SW180A-500	30V	
SW180-382	28V		SW180A-51	48V	INT
SW180-38L			SW180A-52	48V	CONT
SW180-395	12V		SW180A-53	60V	INT
SW180-402	45V		SW180A-54	60V	CONT
SW180-412	24V		SW180A-546		
SW180-421	24V		SW180A-55	72V	INT
SW180-423			SW180A-56	72V	CONT
SW180-428			SW180A-57	80V	INT
SW180-42L	110V		SW180A-58	80V	CONT
SW180-441			SW180A-589	32V	
SW180-456	36V	CONT	SW180A-638	32V	
SW180-457	54V	CONT	SW180AB-12	72V	CONT
SW180-461L	12V	INT	SW180AB-127	240V	
SW180-462	36V	CONT	SW180AB-16	12V	
SW180-463	12V		SW180AB-207	50V	
SW180-464	12V		SW180AB-209	24V	CONT
SW180-480	48V	CONT	SW180AB-237	300V	CONT
SW180-496	24V	CONT	SW180AB-24	24V	INT
SW180-501	24V		SW180AB-328		
SW180-522	48V	CONT	SW180AB-365	80V	CONT
SW180-571L	24V		SW180AB-394	24V	
SW180-579	24V		SW180AB-409	120V	CONT
SW180-586	24V		SW180AB-45		
SW180-594T	24V		SW180AB-450	72/80V	CONT
SW180-646M	24V		SW180AB-451	24V	
SW180-64L			SW180AB-46		
SW180-677L	24V		SW180AB-47	24V	
SW180-695T	24V		SW180AB-48	24V	
SW180-715	24V		SW180AB-481	50V	
SW180-759L			SW180AB-491	60V	
SW180-809	24V	INT	SW180AB-50	36V	
SW180-820	36V		SW180AB-51	48V	
SW180-822	48V		SW180AB-53	60V	
SW180-8226	72/80V		SW180AB-54	60V	
SW180-89	28V	CONT	SW180AB-542	54V	CONT
SW180-895			SW180AB-545	48V	CONT
SW180-9	60V	INT	SW180AB-55	72V	
SW180-94L			SW180AB-56	72V	CONT
SW180-98L			SW180AB-57	80V	
SW180A-12	12V	INT	SW180AB-576	140V	
SW180A-12GE	12V		SW180AB-58	80V	
SW180A-209	24V	CONT	SW180AB-584	144V	
SW180A-24	24V		SW180AB-596	130V	
SW180A-256	60V	CONT	SW180AB-5A	60V	
SW180A-281	24V		SW180AB-603	60V	CONT
SW180A-294	60V		SW180AB-62	96V	
SW180A-310L			SW180AB-630	144V	
SW180A-328	12V	CONT	SW180AB-639	64V	
SW180A-406			SW180AB-65	120V	
SW180A-409	12V	CONT	SW180AB-66	120V	
SW180A-432	36V	CONT	SW180AB-67L		

O.E.M. references are purely indicative and do not imply that parts originate from the original manufacturer.

CONTACTORS



For all our latest catalogue updates and company info: www.tvh.com

used for: **ALBRIGHT**

TYPE	VOLTAGE	COIL TYPE	TYPE	VOLTAGE	COIL TYPE
SW180AB-69L	24V		SW180B-312L		
SW180AB-71L	36V		SW180B-33L	72V	
SW180AB-76L	60V		SW180B-351	24V	
SW180AB-95	36/48V		SW180B-357	48V	CONT
SW180AB-L350	24V	CONT	SW180B-35L		
SW180AB-L585	96V	CONT	SW180B-366	24V	
SW180AB-L68	12V	CONT	SW180B-379	80V	PO
SW180AB-L70	24V	CONT	SW180B-379T	80V	PO
SW180AB-L74	48V	CONT	SW180B-37L	72/80V	
SW180AB-L84	96V	CONT	SW180B-395		
SW180AL-70	24V	CONT	SW180B-400	80V	CONT
SW180B-10	60V		SW180B-407	36/48V	
SW180B-103	36/48V	INT	SW180B-419	48V	
SW180B-106	24V		SW180B-423	24V	
SW180B-108	48V	CONT	SW180B-425	24V	CONT
SW180B-11AG	72V	INT	SW180B-440	48V	PO
SW180B-12	72/80V	INT	SW180B-444	12V	CONT
SW180B-129	24V		SW180B-446		
SW180B-133	40V		SW180B-456		
SW180B-14	80V	CONT	SW180B-470	24V	CONT
SW180B-140	24V	CONT	SW180B-471		
SW180B-144	120V	CONT	SW180B-476	24V	PO
SW180B-146L	48V	INT	SW180B-482	36V	
SW180B-148			SW180B-484		
SW180B-152	12V	PO	SW180B-48F	24V	CONT
SW180B-154			SW180B-492	48V	PO
SW180B-157	72/80V	PO	SW180B-506		
SW180B-164L	48V	PO	SW180B-51		
SW180B-166L			SW180B-513L		
SW180B-18	96V		SW180B-516	60V	CONT
SW180B-199	48V	CONT	SW180B-537	150V	
SW180B-21	120V		SW180B-592	144V	
SW180B-212	72V	CONT	SW180B-6	36V	CONT
SW180B-22	12V		SW180B-605	88V	
SW180B-221	115V	CONT	SW180B-60C		
SW180B-223T	24V		SW180B-640	285V	
SW180B-227			SW180B-686	80V	CONT
SW180B-227L	72/80V		SW180B-72		
SW180B-234	48V		SW180B-729	24V	
SW180B-235	80V		SW180B-740	24V	INT
SW180B-23L	12V	INT	SW180B-9	60V	
SW180B-244	48V		SW180B-91	240V	
SW180B-24L	12V	CONT	SW180B-94L		
SW180B-251			SW180B-98L	48V	
SW180B-254	48V	INT	SW180BL-227	72/80V	
SW180B-255L	12V		SW180BL-24	12V	CONT
SW180B-259	260V		SW180BL-28	36V	CONT
SW180B-25I			SW180BL-29		
SW180B-25L	24V		SW180BL-30	48V	CONT
SW180B-265L			SW180BL-364	80V	CONT
SW180B-26L			SW180BL-368	24V	CONT
SW180B-27L	36V		SW180BL-503	80V	CONT
SW180B-285			SW180EE-355	24V	INT
SW180B-28L	36V		SW180EE-369L	24V	INT
SW180B-293	48V		SW180EE-372		
SW180B-29L	48V	INT	SW180EE-373L		
SW180B-303	36V		SW180EE-380	24V	
SW180B-30L	48V		SW180EE-432	24V	CONT

O.E.M. references are purely indicative and do not imply that parts originate from the original manufacturer.



CONTACTORS

For all our latest catalogue updates and company info: www.tvh.com

used for: **ALBRIGHT**

TYPE	VOLTAGE	COIL TYPE	TYPE	VOLTAGE	COIL TYPE
SW180EE-842			SW181AB-46	15V	CONT
SW180EE-B130L			SW181AB-48	24V	CONT
SW180EL-373	24V	CONT	SW181AB-50	36V	CONT
SW180L-111	24V		SW181AB-51	48V	
SW180L-113	36V		SW181AB-52		
SW180L-267	24V		SW181AB-54	60V	
SW180L-472	36V		SW181AB-56	71V	
SW180L-507	36V	CONT	SW181AB-61		
SW180L-90	28V	CONT	SW181AL-210	24V	CONT
SW180L-94	36/48V		SW181B-10	60V	
SW181-1	12V	INT	SW181B-100		
SW181-10	60V	CONT	SW181B-101		
SW1811-1	72V	INT	SW181B-104		
SW1811-2	72V	CONT	SW181B-11	72V	
SW1811-3	80V	INT	SW181B-141	24V	CONT
SW181-132	12V	CONT	SW181B-142		
SW181-136	36V		SW181B-147		
SW181-14	80V	CONT	SW181B-149		
SW181-141	240V	CONT	SW181B-15	72/80V	
SW181-15	72/80V		SW181B-150	24V	INT
SW181-16			SW181B-152	48V	
SW181-196	48V		SW181B-159		
SW181-198			SW181B-167		
SW181-2	12V	CONT	SW181B-170	24V	
SW181-232			SW181B-182	24V	
SW181-23L			SW181B-185	80V	
SW181-24	24V		SW181B-190	24V	
SW181-246			SW181B-191	36V	PO
SW181-25L			SW181B-192	48V	PO
SW181-26L	24V	CONT	SW181B-199		
SW181-29L			SW181B-20		
SW181-30L			SW181B-200	36V	CONT
SW181-311			SW181B-201	80V	PO
SW181-37L			SW181B-203	24V	
SW181-38L			SW181B-214	110V	CONT
SW181-4	24V	CONT	SW181B-216	48V	PO
SW181-5	36V	INT	SW181B-217	48V	PO
SW181-9	60V	INT	SW181B-218T	80V	
SW181-93			SW181B-219L	80V	PO
SW181-94L			SW181B-224T		
SW181A-20			SW181B-228T	48V	PO
SW181A-207	48V	CONT	SW181B-256T	24V	CONT
SW181A-257	24V		SW181B-267T	24V	PO
SW181A-45	12V	INT	SW181B-268T		
SW181A-46	12V	CONT	SW181B-276		
SW181A-47	24V	INT	SW181B-282	80V	
SW181A-48	24V	CONT	SW181B-283T	80V	
SW181A-49	36V	INT	SW181B-284	24V	
SW181A-50	36V	CONT	SW181B-290	48V	
SW181A-51	48V	INT	SW181B-317T	48V	
SW181A-52	48V	CONT	SW181B-6	36V	CONT
SW181A-53	60V	INT	SW181B-72		
SW181A-54	60V	CONT	SW181D-8	48V	CONT
SW181A-55	72V	INT	SW182-10	60V	CONT
SW181A-56	72V	CONT	SW182-100L	36/48V	
SW181A-57	80V	INT	SW182-102	24V	INT
SW181A-58	80V	CONT	SW182-103	48V	
SW181AB-162	80V	CONT	SW182-104	72/80V	INT

O.E.M. references are purely indicative and do not imply that parts originate from the original manufacturer.

CONTACTORS



For all our latest catalogue updates and company info: www.tvh.com

used for: **ALBRIGHT**

TYPE	VOLTAGE	COIL TYPE	TYPE	VOLTAGE	COIL TYPE
SW182-11	72V	INT	SW182A-52	48V	CONT
SW182-113	24V		SW182A-53	60V	INT
SW182-117	24V		SW182A-54	60V	CONT
SW182-12	72V	INT	SW182A-55	72V	INT
SW182-120L	36V		SW182A-56	72V	CONT
SW182-12E	12V	INT	SW182A-57	80V	INT
SW182-13	80V	INT	SW182A-58	80V	CONT
SW182-14	80V	CONT	SW182AB-224L	48V	
SW182-140	40V		SW182AB-47	24V	
SW182-143	24V	CONT	SW182AB-48	24V	
SW182-148	24V	PO	SW182AB-49	36V	
SW182-15			SW182AB-51	48V	
SW182-16			SW182AB-53		
SW182-18	24V		SW182AB-55		
SW182-198			SW182AB-56	72V	CONT
SW182-1AG	12V	INT	SW182AB-57		
SW182-2	12V	CONT	SW182AB-61		
SW182-204	24V	INT	SW182AB-67L	12V	
SW182-205D	24V	INT	SW182AB-69L		
SW182-207	36/48V		SW182AB-71L	36V	
SW182-209			SW182AB-72		
SW182-210D	48V	INT	SW182AB-L194	48V	
SW182-223			SW182AB-L70	24V	CONT
SW182-228	24V		SW182B-10	60V	CONT
SW182-232	12V	INT	SW182B-111L	24V	
SW182-233	24V		SW182B-113	24V	
SW182-23L			SW182B-11AG	72V	INT
SW182-24	24V	INT	SW182B-12	72V	CONT
SW182-246	48V		SW182B-124D	72/80V	INT
SW182-25L			SW182B-127L	24V	INT
SW182-260	18V		SW182B-135	72/80V	
SW182-269			SW182B-13AG	80V	INT
SW182-26L			SW182B-14	72/80V	CONT
SW182-281	36V		SW182B-143S		
SW182-282	48V		SW182B-144	84V	INT
SW182-295L	24V	CONT	SW182B-145	24V	CONT
SW182-29L			SW182B-148		
SW182-30L			SW182B-149		
SW182-36	36V	INT	SW182B-15	72V/80V	INT
SW182-3648	36/48V		SW182B-150	48V	PO
SW182-36L	80V		SW182B-1522	80V	
SW182-37L			SW182B-162		
SW182-38L			SW182B-16L		
SW182-408			SW182B-17	96V	
SW182-6	36V	CONT	SW182B-186	36V	
SW182-8	48V	CONT	SW182B-193	48V	INT
SW182-80P			SW182B-198		
SW182-9	60V	INT	SW182B-199D		
SW182-93	36/48V		SW182B-2	12V	CONT
SW182-94L			SW182B-20	110V	CONT
SW182-97			SW182B-200	120V	CONT
SW182A-45	12V	INT	SW182B-202	36V	INT
SW182A-46			SW182B-21	96V	
SW182A-47	24V	INT	SW182B-219	36V	PO
SW182A-48	24V	CONT	SW182B-225	72/80V	
SW182A-49	36V	INT	SW182B-234	24V	
SW182A-50	36V	CONT	SW182B-24	24V	INT
SW182A-51	48V	INT	SW182B-247	24V	

O.E.M. references are purely indicative and do not imply that parts originate from the original manufacturer.



CONTACTORS

For all our latest catalogue updates and company info: www.tvh.com

used for: **ALBRIGHT**

TYPE	VOLTAGE	COIL TYPE	TYPE	VOLTAGE	COIL TYPE
SW182B-252	24V	INT	SW190-2	12V	CONT
SW182B-253	36V	INT	SW190-20	110V	CONT
SW182B-25L			SW190-206	24V	CONT
SW182B-261	80V		SW190-24	24V	INT
SW182B-264	36/48V		SW190-269	24V	CONT
SW182B-268			SW190-4	24V	
SW182B-269			SW190-6	36V	CONT
SW182B-273	36V	CONT	SW190-7	48V	
SW182B-277	36/48V	CONT	SW190-89	28V	CONT
SW182B-278	72V		SW190A-110	120V	CONT
SW182B-286	72/80V	CONT	SW190A-111	12V	CONT
SW182B-29			SW190A-45	12V	
SW182B-300T	24V	INT	SW190A-46	12V	
SW182B-33L			SW190A-47	24V	
SW182B-35L			SW190A-68L	12V	CONT
SW182B-4	24V	CONT	SW190A-96L	36V	
SW182B-48	48V	INT	SW190AB-111	12V	CONT
SW182B-508	24V		SW190AB-135	12V	CONT
SW182B-537T	48V		SW190AB-137	220V	
SW182B-72			SW190AB-149	220V	
SW182B-89	28V	CONT	SW190AB-46	12V	
SW182B-9	60V		SW190AB-54	60V	CONT
SW182B-93L			SW190AB-58	80V	
SW182B-98L			SW190AB-68L	12V	
SW182BA-1L	80V		SW190AB-L68	12V	CONT
SW182BL-23	12V		SW190AL-120	28V	CONT
SW182BL-30	48V	CONT	SW190B-10	60V	
SW182BL-33			SW190B-12		
SW182L-119	24V		SW190B-133		
SW182L-12	12V		SW190B-163	48V	CONT
SW182L-120	36V		SW190B-189	28V	CONT
SW182L-204			SW190B-2		
SW182L-205			SW190B-207	120V	CONT
SW182L-24	24V	INT	SW190B-209	120V	CONT
SW182L-241	24V		SW190B-22	120V	CONT
SW182L-25	24V		SW190B-23L	12V	
SW182L-28	36V	CONT	SW190B-262	48V	
SW182L-48	48V		SW190B-300		
SW182L-97			SW190B-4	24V	
SW184-20			SW190B-89	28V	CONT
SW185-26	12V	CONT	SW190BL-24	12V	CONT
SW185-4	115V	CONT	SW190BL-32	60V	CONT
SW185-5	36V		SW190EE-147	24V	
SW185-59	48V		SW192-111	24V	INT
SW185-63	60V	CONT	SW192-118		
SW185A-37	12V	INT	SW192-13	80V	
SW185B-41L			SW192-4	24V	
SW185B-8			SW192-7	48V	INT
SW185B-96	48V		SW192A-48	24V	
SW189AB-16	60V	CONT	SW192AB-131		
SW190-1	12V	INT	SW192AB-46	12V	CONT
SW190-100	12V	CONT	SW192B-10		
SW190-123	24V	CONT	SW192B-103	48V	
SW190-134			SW192B-111	24V	
SW190-147			SW192B-12	72V	CONT
SW190-166	24V	CONT	SW192B-132	48V	
SW190-181	24V	CONT	SW192B-134	48V	INT
SW190-19	110V		SW192B-2		

O.E.M. references are purely indicative and do not imply that parts originate from the original manufacturer.

CONTACTORS



For all our latest catalogue updates and company info: www.tvh.com

used for: **ALBRIGHT**

TYPE	VOLTAGE	COIL TYPE	TYPE	VOLTAGE	COIL TYPE
SW192B-3	24V		SW200-487	11V	
SW192B-36L			SW200-50	60V	INT
SW192B-8	48V		SW200-510	36V	CONT
SW200-177	72V	INT	SW200-511	24V	CONT
SW200-637	48V	CONT	SW200-52	48V	
SW200-01	48V	INT	SW200-527	48V	CONT
SW200-104	60V	CONT	SW200-533	60V	CONT
SW200-11			SW200-555	60V	
SW200-113	96V		SW200-564	48V	CONT
SW200-114	48V		SW200-580	48V	CONT
SW200-117			SW200-583	80V	
SW200-1248	48V	INT	SW200-599	230V	
SW200-132	120V		SW200-61		
SW200-139	12V	CONT	SW200-660	72V	CONT
SW200-160			SW200-702		
SW200-166			SW200-712	56V	CONT
SW200-167	24V	CONT	SW200-720		
SW200-176	80V	CONT	SW200-740		
SW200-19	80V		SW200-771M	24V	
SW200-192			SW200-80	24V	CONT
SW200-200			SW200-802T		
SW200-214	36/48V		SW200-808		
SW200-2158	36/48V		SW200-81	36V	
SW200-218	80V	INT	SW200-825	80V	
SW200-22	12V	INT	SW200-84	24V	CONT
SW200-223	140V		SW200-859	36V	CONT
SW200-230	36V	CONT	SW200-862	80V	
SW200-232	24V		SW200-879		
SW200-239			SW200-88	24V	CONT
SW200-255	48V		SW200-89		
SW200-256	80V	INT	SW200-91	28V	
SW200-265	12V		SW200-951	48V	CONT
SW200-27	96V	CONT	SW200-961	48V	
SW200-277	72V	INT	SW200-990	48V	CONT
SW200-279	36/48V	CONT	SW200A-10	60V	CONT
SW200-28	120V	CONT	SW200A-105	80V	INT
SW200-281	24V	INT	SW200A-106	60V	INT
SW200-282	36V	INT	SW200A-111	50V	CONT
SW200-283	48V	INT	SW200A-117		
SW200-285	24V	CONT	SW200A-127		
SW200-286	80V		SW200A-128	48V	CONT
SW200-292	48V	CONT	SW200A-14	48V	INT
SW200-317	36V	INT	SW200A-140		CONT
SW200-329	36V	INT	SW200A-152	32V	CONT
SW200-332			SW200A-153	120V	CONT
SW200-333			SW200A-16	12V	CONT
SW200-334	48V	PO	SW200A-161	80V	CONT
SW200-336	24V	CONT	SW200A-162	96V	
SW200-337	12V		SW200A-176		
SW200-342	24V	PO	SW200A-179	36V	
SW200-364	60V	CONT	SW200A-188	36V	CONT
SW200-365	6V	CONT	SW200A-189	72V	INT
SW200-368			SW200A-192	72V	CONT
SW200-369D	48V	INT	SW200A-194	48V	
SW200-381	28V		SW200A-210		
SW200-393	220V		SW200A-211	12V	CONT
SW200-419	24V		SW200A-217	50V	
SW200-464	48V	CONT	SW200A-24		

O.E.M. references are purely indicative and do not imply that parts originate from the original manufacturer.



CONTACTORS

For all our latest catalogue updates and company info: www.tvh.com

used for: **ALBRIGHT**

TYPE	VOLTAGE	COIL TYPE	TYPE	VOLTAGE	COIL TYPE
SW200A-241	24V	CONT	SW200B-9	72V	
SW200A-25	24V		SW200EE-463	24V	
SW200A-261			SW200EE-691	36/48V	
SW200A-305	24V	CONT	SW200L-404	36V	
SW200A-306	48V	CONT	SW200L-406	24V	
SW200A-310	72V	CONT	SW200N-1	48V	
SW200A-32			SW200N-139	12V	CONT
SW200A-35	24V	INT	SW200N-15		
SW200A-367	50V		SW200N-173	12V	CONT
SW200A-391	24V		SW200N-183	120V	CONT
SW200A-41	72V	INT	SW200N-19	110V	CONT
SW200A-427	12V	CONT	SW200N-2	24V	INT
SW200A-430	12V	CONT	SW200N-20	48V	CONT
SW200A-44			SW200N-210	12V	CONT
SW200A-467	420V	CONT	SW200N-224	24V	CONT
SW200A-471	180V	CONT	SW200N-225	12V	
SW200A-478	80V		SW200N-230	36V	
SW200A-502	48V		SW200N-233	36V	
SW200A-509	180V	CONT	SW200N-262		
SW200A-517			SW200N-284	30V	CONT
SW200A-525	12V	CONT	SW200N-285	14V	CONT
SW200A-539	72/80V	INT	SW200N-331		
SW200A-547			SW200N-342	24V	PO
SW200A-553	54V	CONT	SW200N-344	120V	
SW200A-587	36V	CONT	SW200N-368D	24V	INT
SW200A-630			SW200N-369	48V	
SW200A-701			SW200N-482	24/36V	
SW200A-711	60V		SW200N-484	48V	
SW200A-732	96V	CONT	SW200N-494		
SW200A-760	64V		SW200N-528	120V	CONT
SW200A-761	144V		SW200N-588	120V	CONT
SW200A-762	285V		SW200N-67	48V	
SW200A-878	48V	PO	SW200N-715		
SW200A-93	43V		SW200N-742	36V	
SW200AB-44			SW200N-8	36V	INT
SW200AB-72	72V		SW200N-80	24V	
SW200AN-11	24V	CONT	SW200N-91	28V	CONT
SW200AN-117	24V		SW200N-92	36V	CONT
SW200AN-168			SW201-1	80V	INT
SW200AN-211	12V	CONT	SW201-104	12V	
SW200AN-391	24V		SW201-108	80V	INT
SW200AN-44	28V	CONT	SW201-118	12V	CONT
SW200AN-626			SW201-127	12V	CONT
SW200AN-759			SW201-137	60V	CONT
SW200AN-96	36V	INT	SW201-139	24V	CONT
SW200B-114			SW201-144	120V	CONT
SW200B-131	80V		SW201-154	48V	INT
SW200B-177			SW201-167		
SW200B-257	80V		SW201-173T		
SW200B-320			SW201-174T	36V	PO
SW200B-334			SW201-178T		
SW200B-335			SW201-179		
SW200B-342			SW201-186T	72/80V	
SW200B-423			SW201-188	80V	PO
SW200B-50			SW201-19	36V	CONT
SW200B-503			SW201-199	72/80V	
SW200B-80	72/80V	CONT	SW201-20	12V	
SW200B-88	24V		SW201-207T		

O.E.M. references are purely indicative and do not imply that parts originate from the original manufacturer.

CONTACTORS



For all our latest catalogue updates and company info: www.tvh.com

used for: **ALBRIGHT**

TYPE	VOLTAGE	COIL TYPE	TYPE	VOLTAGE	COIL TYPE
SW201-210T	48V		SW202-202	48V	CONT
SW201-24	24V		SW202-216	80V	INT
SW201-241			SW202-221	48V	INT
SW201-245	80V	PO	SW202-225		
SW201-253T	24V		SW202-23	48V	
SW201-26	72V	CONT	SW202-232	72V	CONT
SW201-29	12V	CONT	SW202-235	80V	
SW201-31	48V	INT	SW202-236		
SW201-50	12V	INT	SW202-239T	80V	
SW201-58	24V		SW202-24	24V	INT
SW201-59	120V	CONT	SW202-240	24V	
SW201-62	36/48V		SW202-250		
SW201-63	60V	CONT	SW202-27	72V	INT
SW201-7	220V		SW202-28	72V	
SW201-76	24V		SW202-34	96V	INT
SW201-8	72V	INT	SW202-37	24V	
SW201-84	24V	INT	SW202-397		
SW201-86	24V	INT	SW202-4148	48V	CONT
SW201A-12	24V	INT	SW202-42	60V	CONT
SW201A-122	60V		SW202-51	24V	
SW201A-14	24V	CONT	SW202-53	60V	INT
SW201A-25	60V	CONT	SW202-57	144V	INT
SW201A-30	12V	CONT	SW202-58	12V	
SW201A-32	48V	INT	SW202-6	24V	INT
SW201A-38	12V	INT	SW202-60	12V	CONT
SW201A-39	48V	CONT	SW202-62	36V	CONT
SW201A-40	80V	CONT	SW202-8	48V	
SW201A-41	36V	CONT	SW202-80	72/80V	CONT
SW201A-47	80V	CONT	SW202-83	48V	
SW201A-74	72V	CONT	SW202-84	24V	CONT
SW201A-90	96V		SW202-86	110V	
SW201AN-14	24V	CONT	SW202-9	12V	INT
SW201N-29	12V	CONT	SW202-95	72/80V	
SW201N-31			SW202-97	144V	
SW202-10	72V	PO	SW202A115	72V	CONT
SW202-102	120V		SW202A-12	24V	INT
SW202-104	12V	CONT	SW202A-120	36V	CONT
SW202-109	96V		SW202A-13	36V	INT
SW202-118	110V	CONT	SW202A-167	28V	CONT
SW202-12			SW202A-17	12V	INT
SW202-128	96V		SW202A-18	48V	INT
SW202-129			SW202A-181		
SW202-13	36V	INT	SW202A-19	72V	INT
SW202-134	60V	INT	SW202A-199	72/80V	
SW202-14	24V	INT	SW202A-24	24V	CONT
SW202-141	36V		SW202A-249		
SW202-142	48V	CONT	SW202A-25		
SW202-144	80V		SW202A-28	72V	
SW202-15			SW202A-47	80V	INT
SW202-150			SW202A-63	80V	CONT
SW202-152	48V	INT	SW202A-64	48V	
SW202-158	36/48V		SW202A-76	48V	
SW202-16	24V	CONT	SW202A-81	12V	CONT
SW202-165	110V	CONT	SW202AB-77	72V	INT
SW202-170	80V		SW202AN-237	110V	CONT
SW202-182			SW202AT-243	24V	
SW202-193	80V		SW202B-1		
SW202-20	36V		SW202B-108		

O.E.M. references are purely indicative and do not imply that parts originate from the original manufacturer.



CONTACTORS

For all our latest catalogue updates and company info: www.tvh.com

used for: **ALBRIGHT**

TYPE	VOLTAGE	COIL TYPE	TYPE	VOLTAGE	COIL TYPE
SW202B-109			SW210-123	48V	INT
SW202B-122			SW210-126		
SW202B-133			SW210-127	60V	CONT
SW202B-140			SW210-132	72V	
SW202B-152			SW210-2	12V	CONT
SW202B-154			SW210-5	36V	
SW202B-27			SW210-6	36V	CONT
SW202EE-185	24V		SW210-7	48V	INT
SW202N-119			SW210A-118	80V	
SW202N-141	36V	CONT	SW210A1-44	80V	
SW202N-2	24V		SW210A-50	36V	CONT
SW202N-238	110V	CONT	SW215-16	80V	INT
SW202N-295	12V		SW215-17	48V	INT
SW202N-58	12V		SW215-80	80V	INT
SW202N-6			SW215A-15	48V	INT
SW202N-60	12V	CONT	SW215A-8	80V	INT
SW202N-69	120V		SW215A-9	48V	INT
SW202N-84	12V	CONT	SW215N-13	36V	
SW202N-9	12V		SW218-1036A		
SW2031L			SW250-1016	24V	
SW203-3	120V		SW280-1	28V	CONT
SW204-1	24V		SW280AB-3		
SW204-167	36V	CONT	SW280B-114	48V	
SW204-173	64V		SW280B-1166		
SW204-195	48V	CONT	SW280B-117		
SW204-215	48V		SW280B-38	24V	CONT
SW204-4	28V		SW280B-70	48V	
SW204-53	48V	CONT	SW280B-8	12V	
SW204-58	12V	CONT	SW280B-86	36/48V	
SW204-60	24V	INT	SW280B-87	72/80V	INT
SW204-63	120V	CONT	SW282-4		
SW204-69	14V	CONT	SW338-282		
SW204-7	72V	INT	SW401-2		
SW2047-4	60V		SW401-4T		
SW204-8			SW600-10	24V	
SW204-81	96V		SW600-131	72/80V	INT
SW204-83	6V	CONT	SW600-17	24V	CONT
SW204A-117	24V	CONT	SW600-2	60V	CONT
SW204A-142	12V		SW600-20	33V	
SW204A-166	36V	CONT	SW600-3	24V	INT
SW204A-185	96V		SW600-39D		
SW204A-48	28V		SW600-54	36V	INT
SW204A-70	24V		SW600-58	48V	INT
SW204A-78	110V	CONT	SW600-7	48V	CONT
SW204A-82	120V	CONT	SW600-8	12V	
SW204N-3	36V	CONT	SW600-93	36/48V	INT
SW207-0151			SW600A-1	28V	CONT
SW207-041			SW600A-11	24V	CONT
SW208-33	24V	CONT	SW600A-11D	28V	
SW208-36	36V	CONT	SW600A-2	28V	CONT
SW208-4	28V		SW600A-3	60V	
SW208-42	270V	CONT	SW600A-43	28V	
SW208-44	24V	CONT	SW600A-51T	24V	CONT
SW210-04	24V	CONT	SW600A-53	28V	CONT
SW210-100	120V		SW600A-65	56V	CONT
SW210-104	230V		SW600A-66	28V	
SW210-110	9V	CONT	SW600A-69	60V	
SW210-113	120V	CONT	SW600A-70	48V	CONT

O.E.M. references are purely indicative and do not imply that parts originate from the original manufacturer.

CONTACTORS



For all our latest catalogue updates and company info: www.tvh.com

used for: **ALBRIGHT**

TYPE	VOLTAGE	COIL TYPE	TYPE	VOLTAGE	COIL TYPE
SW600A-72	125V		SW62A-124		
SW601	12V		SW62A-124M		
SW601-09			SW62A-136	12V	
SW601-17P			SW62A-137	24V	
SW601-39P	12V		SW62A-22	72V	CONT
SW601-4	80V		SW62A-22M	72V	
SW601-47			SW62A-24	24V	
SW601-48P			SW62A-33	12V	
SW601-49P			SW62A-44		
SW601-53P			SW62A-44M	36V	INT
SW601-83	24V		SW62A-49M	72V	
SW602			SW62A-5M		
SW602-00			SW62A-60	200V	CONT
SW602-011	24V		SW62A-66		
SW602-03P	24V		SW62A-86	48V	CONT
SW602-65	24V		SW62A-89	24V	CONT
SW602-78	48V		SW62A-90		
SW602A-1	28V	CONT	SW62A-91	36/48V	CONT
SW603	24V		SW62A-96	12V	CONT
SW603-50P	12V	INT	SW62A-97		
SW603-51P			SW62A-98	36V	
SW604	24V		SW62A-99M	36V	
SW606	36V	CONT	SW62C-56	36V	
SW608			SW64A-108	24V	
SW60A-175M			SW64A-22	24V	CONT
SW60A-176	24V		SW64A49M	72V	
SW60A-20			SW64B-107		
SW60A-22			SW65-1	24V	INT
SW60AB-22			SW65-1112		
SW60B-131			SW65-26	48V	
SW60B-14	80V	CONT	SW65-3		
SW60B-179	12V	CONT	SW65-45M	48V	
SW60B-182	28V	CONT	SW65A-1		
SW60B-193	80V	CONT	SW65A-11		
SW60B-2			SW65A-2	24V	
SW60B-238			SW65A-3		
SW60B-258	48V	CONT	SW65A-33	12V	
SW60B-266	48V		SW65A-33M		
SW60B-348			SW65A-43	12V	INT
SW60B-4			SW65A-49		
SW61-1	12V		SW65A-57M	240V	
SW61-105	48V		SW65A-58	200V	
SW61A-22	24V	CONT	SW65A-63	24V	
SW61B-4			SW65A-64	12V	
SW62-085A	36V	INT	SW65A-65M	36V	
SW62-090A	36V	CONT	SW65A-8M	72V	
SW62-102M	48V		SW66-106		
SW62-107	48V	INT	SW66-122	24V	
SW62-12	12V	INT	SW70-7		
SW62-13	16V	INT	SW70-72M	24V	
SW62-98	80V	INT	SW70A-1	24V	
SW62A-101	24V		SW70A-2	36V	
SW62A-102	72V		SW70A-62	24V	
SW62A-10M	48V	INT	SW70A-7		
SW62A-113			SW70A-70		
SW62A-114M			SW70A-70M	24V	
SW62A-123			SW70A-72		
SW62A-123M			SW70A-72M	24V	

O.E.M. references are purely indicative and do not imply that parts originate from the original manufacturer.



CONTACTORS

For all our latest catalogue updates and company info: www.tvh.com

used for: **ALBRIGHT**

TYPE	VOLTAGE	COIL TYPE	TYPE	VOLTAGE	COIL TYPE
SW711-11B	110V		SW801-86	36V	CONT
SW711-7B	48V		SW801-89	60V	CONT
SW74-18	12V	INT	SW801-93	36V	
SW74-18M	12V		SW802-00	14V	CONT
SW75-16			SW802-04		
SW75-16M	48V		SW802-12		
SW75-38	12V		SW802-20	24V	CONT
SW75-39	24V		SW802-23L	24V	
SW75-42	24V		SW802-32		
SW75-42M	24V		SW802-39	40V	
SW75-44	48V		SW802-43	80V	
SW76-1	24V		SW802-46	36/48V	
SW807-39L	24V	INT	SW802-54	120V	CONT
SW803-04L	24V	INT	SW802-55L	24V	CONT
SW800-04	24V		SW802-58		
SW800-24	24V		SW80-269	115V	CONT
SW801-010P	36V		SW802-8	28V	CONT
SW801-025	28V	CONT	SW802-83	12V	CONT
SW801-05F	24V		SW802-84	24V	CONT
SW801-06	48V	CONT	SW802-95L		
SW801-062	24V	CONT	SW803-07		
SW801-065P	48V		SW803-0F	80V	INT
SW801-06F	48V		SW803-16		
SW801-16	24V	CONT	SW803-25	24V	
SW801-160	24V		SW803-36		
SW801-17L			SW803-37		
SW801-2	12V	INT	SW803-5	12V	CONT
SW801-25	12V	INT	SW803-53P	36V	
SW801-275P			SW803-57P	24V	
SW801-3	60V	CONT	SW803-58	12V	CONT
SW801-307P	80V		SW803-61L		
SW801-326L	24V		SW803-648	36/48V	CONT
SW801-382L	24V		SW803-74P	12V	
SW801-383L	24V	CONT	SW803-75P	24V	
SW801-385PL	24V		SW803-78P		
SW801-4	12V	CONT	SW803-78PL	24V	
SW801-40	24V		SW803-81P		
SW801-41L			SW803-83P	36V	
SW801-424	24V		SW803-84P	12V	
SW801-47L			SW803-9	36/48V	
SW801-488	24V	CONT	SW803-90P	12V	
SW801-489L			SW803-98L		
SW801-5	72V	CONT	SW803-998	24V	INT
SW801-524L	24V		SW804-05	24V	
SW801-538L	24V		SW804-11		
SW801-56	48V	CONT	SW804-14	36V	CONT
SW801-595L			SW804-15P	48V	
SW801-608P	48V	INT	SW804-19	72V	
SW801-61			SW804-21	80V	CONT
SW801-614PE	24V		SW804-22	24V	CONT
SW801-66	30V		SW804-25	36/48V	CONT
SW801-666L			SW804-3		
SW801-67F	48V	INT	SW804-36P	24V	
SW801-723P			SW804-41	24V	CONT
SW801-75	72V	CONT	SW804-424		
SW801-78	60V		SW804-5L		
SW801-81	120V	CONT	SW804-7	36V	CONT
SW801-84	24V	CONT	SW804-71	24V	CONT

O.E.M. references are purely indicative and do not imply that parts originate from the original manufacturer.

CONTACTORS



For all our latest catalogue updates and company info: www.tvh.com

used for: **ALBRIGHT**

TYPE	VOLTAGE	COIL TYPE	TYPE	VOLTAGE	COIL TYPE
SW804-72	24V	CONT	SW808-26PL	24V	
SW804-73	48V		SW808-28488		
SW804-75PL	12V		SW808-30	24V	
SW804-8V	48V	INT	SW808-37P	24V	
SW804-9			SW808-53P	36/48V	CONT
SW804-93L			SW808-83T		
SW804-B40			SW808-84	80V	
SW804-GN			SW808-87P	24V	
SW805-08			SW808-87PE		
SW805-4			SW808-90L		
SW805-40			SW808-96P		
SW805-6	12V		SW808-97L	24V	INT
SW805-69L	24V	INT	SW808-98P	48V	CONT
SW805-6F	12V		SW809-00		
SW805-7			SW809-1		
SW805-70	80V		SW809-48		
SW805-71	24V	INT	SW809-55T	24V	CONT
SW805-75L			SW809-58	36V	
SW805-92			SW809-78L	48V	INT
SW806-0			SW809-8	12V	
SW806-08P			SW80A-124	48V	CONT
SW806-13P			SW80A-152	48V	CONT
SW806-15	24V	CONT	SW80A-16	12V	INT
SW806-2			SW80A-17	12V	CONT
SW806-29	12V	PO	SW80A-19	24V	CONT
SW806-3	28V	CONT	SW80A-195		
SW806-30P	36V		SW80A-20	36V	INT
SW806-4	24V		SW80A-202	80V	INT
SW806-42	12V		SW80A-21	36V	CONT
SW806-60			SW80A-22	48V	INT
SW806-61	24V	CONT	SW80A-225	115V	CONT
SW806-772			SW80A-233	60V	
SW806-78			SW80A-24	60V	INT
SW806-80L	24V		SW80A-25	60V	CONT
SW806-84	24V	CONT	SW80A-26	72V	INT
SW806-86	24V	CONT	SW80A-27	72V	CONT
SW806-96	12V	CONT	SW80A-29	28V	CONT
SW807-04	48V	INT	SW80A-296	24V	CONT
SW807-12PL	12V		SW80A-305	120V	CONT
SW807-19L			SW80A-331	160V	CONT
SW807-20L			SW80A-38	80V	CONT
SW807-34			SW80A-398	36/48V	
SW807-41	24V		SW80A-412	54V	CONT
SW807-42	24V		SW80A-437	120V	
SW807-46P	12V		SW80A-537	52V	CONT
SW807-47P	24V	CONT	SW80A-585	60V	
SW807-54P			SW80A-61	24V	INT
SW807-63	24V		SW80A-669	24V	
SW807-68PE	12V	INT	SW80A-765	60V	CONT
SW807-69PE	24V	INT	SW80A-87	30V	
SW807-76	110V	CONT	SW80A-902	32V	CONT
SW807-AG	36V	INT	SW80A-903P		
SW808-0	16V		SW80A-990	36V	
SW808-0E			SW80A-991	48V	CONT
SW808-1	240V		SW80AB-1004	140V	
SW808-10	36V		SW80AB-1089	32V	
SW808-20P			SW80AB-1090	64V	
SW808-2273L			SW80AB-1091	144V	

O.E.M. references are purely indicative and do not imply that parts originate from the original manufacturer.



CONTACTORS

For all our latest catalogue updates and company info: www.tvh.com

used for: **ALBRIGHT**

TYPE	VOLTAGE	COIL TYPE	TYPE	VOLTAGE	COIL TYPE
SW80AB-1092	285V		SW80B-243	80V	
SW80AB-115	110V		SW80B-245L	80V	CONT
SW80AB-120			SW80B-252	60V	CONT
SW80AB-16	12V		SW80B-255	80V	
SW80AB-17	12V		SW80B-260	72V	CONT
SW80AB-18	24V		SW80B-269	115V	CONT
SW80AB-19	24V	CONT	SW80B-276	96V	
SW80AB-22	60V	CONT	SW80B-286	36/48V	CONT
SW80AB-230	120V	CONT	SW80B2-90L	24V	
SW80AB-233	60V		SW80B-301	36/48V	
SW80AB-25			SW80B-305P	36/48V	
SW80AB-26	72V	INT	SW80B-351	12V	
SW80AB-27	72V		SW80B-398	36/48V	CONT
SW80AB-29			SW80B-39AG	36/48V	INT
SW80AB-305	110V	CONT	SW80B-4		
SW80AB-33			SW80B-406	72/80V	CONT
SW80AB-349	110V	CONT	SW80B-413	125V	
SW80AB-412	54V	CONT	SW80B-417L	48V	CONT
SW80AB-476	120V	CONT	SW80B-473	48V	CONT
SW80AB-531	24V	CONT	SW80B-489		
SW80AB-564	135V		SW80B-491	24V	INT
SW80AB-585	60V		SW80B-497		
SW80AB-605	54V	CONT	SW80B-538	72V	CONT
SW80AB-669	24V		SW80B-539		
SW80AB-690	50V	CONT	SW80B-543	48V	CONT
SW80AB-697	12V	CONT	SW80B-557		
SW80AB-818	127V		SW80B-562		
SW80AB-889	24V		SW80B-574	60V	
SW80AB-89	28V	CONT	SW80B-58	12V	CONT
SW80ABL-695	24V	CONT	SW80B-59	24V	CONT
SW80AL-P802	48V		SW80B-637	12V	CONT
SW80AP-903	72V	CONT	SW80B-644	60V	CONT
SW80AP-992	48V	CONT	SW80B-65	24V	CONT
SW80AT-1018	36V	CONT	SW80B-687	36/48V	CONT
SW80B-1014	140V		SW80B-69	110V	
SW80B-1031	60V	CONT	SW80B-775	60V	
SW80B-1032	88V		SW80B-78	120V	CONT
SW80B-1040L			SW80B-81	240V	CONT
SW80B-1045	220V		SW80B-838	60V	CONT
SW80B-105F	24V		SW80B-844L	96V	
SW80B-106	48V		SW80B-871	90V	CONT
SW80B-113L	24V	INT	SW80B-883		
SW80B-1148	48V	INT	SW80B-937	72/80V	CONT
SW80B-12	60V	INT	SW80B-96		
SW80B-124	24V	INT	SW80B-966	120V	CONT
SW80B-13	60V	CONT	SW80B-988	110V	
SW80B-1336L	80V		SW80B-993	60V	CONT
SW80B-14	72V		SW80BL-131	24V	CONT
SW80B-171			SW80BL-147	12V	
SW80B-174			SW80BL-151	30V	CONT
SW80B-178	60V	CONT	SW80BL-732	28V	CONT
SW80B-181	120V	CONT	SW80BL-748	74V	CONT
SW80B-193	36V	CONT	SW80BL-812	74V	CONT
SW80B-222			SW80BV-132	132V	CONT
SW80B-223	120V		SW80EE-567	24V	CONT
SW80B-224	65V	CONT	SW80EE-573	24V	
SW80B-226	36/48V		SW80EE-611	12V	
SW80B-239	40V		SW80EE-683	24V	CONT

O.E.M. references are purely indicative and do not imply that parts originate from the original manufacturer.

CONTACTORS



For all our latest catalogue updates and company info: www.tvh.com

used for: **ALBRIGHT**

TYPE	VOLTAGE	COIL TYPE	TYPE	VOLTAGE	COIL TYPE
SW80EE-786	24V	CONT	SW822-17L		
SW80EE-972	24V	CONT	SW822-18L		
SW80EE-B651L			SW822-22L		
SW80EE-B652L			SW822-23L		
SW80L-313	24V		SW822-6L	36V	CONT
SW80LP-354	36V	CONT	SW822-32L	24V	
SW80N-390	24V		SW822-36L		
SW80P-353	36V	CONT	SW822-40	24V	CONT
SW80P-357	24V	CONT	SW822-47P	12V	
SW80P-374	12V	INT	SW822-5	36V	INT
SW80P-384	13.8V	CONT	SW822-54L	48V	
SW80P-390	12V	CONT	SW822-55	24V	INT
SW80P-415	48V	CONT	SW822-60	24V	CONT
SW80P-416	48V	CONT	SW822-61	24V	INT
SW80P-522	48V	CONT	SW822-62PL		
SW80P-702	12V	CONT	SW822-65P	36V	
SW80P-727	48V	CONT	SW822-69	12V	INT
SW80P-747	24V	CONT	SW822-7	48V	INT
SW80P-754	36V	CONT	SW822-71		
SW80P-938			SW822-8	48V	CONT
SW80P-98	240V		SW822A-01L	24V	INT
SW80PL-475	12V		SW822AF-15L	24V	
SW80PT-778	24V	CONT	SW822P-42	36V	CONT
SW82-2	12V	CONT	SW822P-47	12V	
SW82-0828	24V	CONT	SW822P-50	12V	CONT
SW82-1	12V	INT	SW822P-52	48V	CONT
SW82-10	60V	CONT	SW822P-53	48V	CONT
SW82-102			SW822P-54	24V	CONT
SW82-104	24V		SW822P-65	36V	CONT
SW82-109	24V	INT	SW823-0	24V	
SW82-11	72/80V	INT	SW823-1	24V	CONT
SW82-126	24V	CONT	SW823-2L		
SW82-13	80V	CONT	SW823-8	30V	
SW82-139PL	24V	INT	SW823-9		
SW82-14	28V	CONT	SW824-7		
SW82-1482	24V		SW824-9	32V	CONT
SW82-148L	24V	INT	SW825-4	110V	CONT
SW82-15			SW825-8	110V	CONT
SW82-158P			SW826	36V	CONT
SW82-161L	24V	CONT	SW826-6		
SW82-16L			SW826-6P		
SW82-17L			SW827	48V	INT
SW82-181T	24V	CONT	SW828-2FL	24V	CONT
SW82-189	24V	CONT	SW828-6	24V	CONT
SW82-1972			SW828-7	24V	CONT
SW822-2	12V	CONT	SW828-8L	28V	
SW822-3	24V	INT	SW829	60V	INT
SW822-4	24V	CONT	SW829-3	12V	CONT
SW822-48P	24V	INT	SW82A-127	12V	CONT
SW822-0160	24V	INT	SW82A-144	24V	
SW822-07061			SW82A-170	32V	CONT
SW822-1	12V	INT	SW82L-118	24V	CONT
SW822-10	60V	CONT	SW82L-120	24V	CONT
SW822-11	72/80V	INT	SW82L-16	12V	
SW822-12	72V	CONT	SW82P-157	48V	CONT
SW822-3	80V	CONT	SW82P-160	12V	CONT
SW822-14			SW82P-195	96V	CONT
SW822-16			SW841-0	60V	INT

O.E.M. references are purely indicative and do not imply that parts originate from the original manufacturer.



CONTACTORS

For all our latest catalogue updates and company info: www.tvh.com

used for: **ALBRIGHT**

TYPE	VOLTAGE	COIL TYPE	TYPE	VOLTAGE	COIL TYPE
SW841-02	28V	CONT	SW84B-219	24V	
SW841-07	48V	CONT	SW84B-223	24V	
SW841-09	6V	CONT	SW84B-24	24V	INT
SW841-1	60V	CONT	SW84B-3	12V	
SW841-10	4V	CONT	SW84B-30	24V	CONT
SW841-2	12V	CONT	SW84B-31	80V	
SW841-25	24V		SW84B-36	36V	INT
SW841-28	36/48V		SW84B-4	24V	CONT
SW841-29	24V	CONT	SW84B-48		
SW841-3	72V	CONT	SW84B-5		
SW841-53			SW84B-67	120V	CONT
SW841-55			SW84B-7	48V	
SW841-77T	48V	INT	SW84B-8	48V	CONT
SW842-24	12V		SW84B-80		
SW842-4	72V		SW84B-89	48V	CONT
SW842-6	80V	INT	SW84B-98	120V	CONT
SW842-61	12V		SW851-06		
SW843-0	24V		SW851-6		
SW843-1	80V	CONT	SW851-71	12V	CONT
SW843-6			SW852	24V	
SW843-AG	12V	PO	SW852-0	12V	CONT
SW844-8	36/48V	CONT	SW853-7	12V	
SW845	36V	INT	SW855-0	48V	
SW846	36V	CONT	SW856-5	28V	
SW846-7	120V	CONT	SW857-4	110V	
SW847-AG	48V	INT	SW858-9	48V	
SW849-4	24V	CONT	SW859	24V	INT
SW849-6	72V	CONT	SW85A-57	120V	
SW849-7	12V	CONT	SW85AP-T174		
SW84A-136	60V	CONT	SW85AT-173		
SW84A-137	120V	CONT	SW85B-108	48V	CONT
SW84A-14	12V		SW85B-115	60V	CONT
SW84A-15	12V		SW85B-117	60V	CONT
SW84A-16	24V		SW85B-2	24V	
SW84A-168			SW85B-20	12V	
SW84A-17	24V		SW85B-50	48V	
SW84A-172	54V	CONT	SW85B-91	80V	
SW84A-19	36V	CONT	SW85PT-172	24V	CONT
SW84A-20	48V		SW867	36V	CONT
SW84A-2417T	24V	INT	SW86A-10	12V	INT
SW84A-250	48V		SW86A-19	48V	
SW84A-3	12V	INT	SW86P-190	12V	CONT
SW84A-60			SW88-10	60V	CONT
SW84AB-16	24V		SW88-101	12V	
SW84AB-20	48V		SW88-104L		
SW84AB-21	48V		SW88-11	72V	INT
SW84AB-23	60V	CONT	SW88-116	24V	INT
SW84AB-61	120V	CONT	SW88-119	24V	INT
SW84B-1	24V	INT	SW88-12	72V	CONT
SW84B-113	110V	CONT	SW88-120	24V	
SW84B-128			SW88-124		
SW84B-130			SW88-12V	12V	INT
SW84B-143	48V		SW88-134	24V	
SW84B-170	28V	CONT	SW88-142L		
SW84B-180T	80V	PO	SW88-143	48V	
SW84B-181T	48V	PO	SW88-150	36V	CONT
SW84B-182T			SW88-151	48V	CONT
SW84B-212T	24V	PO	SW88-158L		

O.E.M. references are purely indicative and do not imply that parts originate from the original manufacturer.

CONTACTORS



For all our latest catalogue updates and company info: www.tvh.com

used for: **ALBRIGHT**

TYPE	VOLTAGE	COIL TYPE	TYPE	VOLTAGE	COIL TYPE
SW88-161	36V		SW88B-257T	48V	
SW88-163			SW88B-28	48V	
SW88-164T	12V	INT	SW88B-30		
SW88-167T	24V	INT	SW88B-36		
SW88-169	24V	CONT	SW88B-55	24V	CONT
SW882	12V	CONT	SW88B-6	36V	CONT
SW882-5AG	80V	INT	SW88B-67	12V	INT
SW882-7	24V	INT	SW88B-7	48V	
SW882-8	36/48V		SW88B-74	72/80V	
SW883-4	12V		SW88B-76	36/48V	
SW883-5	12V	INT	SW88B-79	48V	
SW884-6	24V	INT	SW88B-8	48V	CONT
SW884-8	48V		SW88B-80	36/48V	
SW885-1	80V	CONT	SW88B-92	110V	CONT
SW885-5	24V	CONT	SW88B-94	36V	INT
SW886	36V	CONT	SW88B-96	230V	CONT
SW886-6	120V	CONT	SW88LB-48	48V	
SW886-7	12V		SW89-107	48V	
SW886-9	12V		SW89-11	24V	
SW887-3			SW89-18M	12V	
SW887-4			SW89-21M	72V	
SW887-5	36V		SW89-42	48V	
SW887-6			SW89-42M		
SW887-8L			SW89-43		
SW887-AG	48V	INT	SW89-63	48V	
SW888-3	12V		SW90-177		
SW889	60V	INT	SW92-1	24V	INT
SW88A-13	12V	INT	SW92-1K1	24V	
SW88A-14	12V	CONT	SW92-2	24V	
SW88A-15	24V	INT	SW92-3L	24V	INT
SW88A-16	24V	CONT	SW92-1L	24V	
SW88A-17	36V	INT	SW92-7	24V	INT
SW88A-18	36V	CONT	SW92B-29	60V	
SW88A-19	48V	INT			
SW88A-20	48V	CONT			
SW88A-21	60V	INT			
SW88A-22	60V	CONT			
SW88A-23	72V	INT			
SW88A-24	72V	CONT			
SW88AB-15					
SW88AB-16	24V				
SW88AB-19	48V				
SW88AB-20	48V	INT			
SW88AB-21	60V				
SW88AB-22	48V				
SW88AB-23	72V				
SW88AB-48	48V				
SW88AB-L159	24V	CONT			
SW88B-1	24V	INT			
SW88B-104L	24V	INT			
SW88B-114	220V	CONT			
SW88B-122	48V				
SW88B-128	24V	INT			
SW88B-134					
SW88B-149					
SW88B-2	12V	CONT			
SW88B-24	24V				
SW88B-25	24V				

O.E.M. references are purely indicative and do not imply that parts originate from the original manufacturer.



CONTACTORS

For all our latest catalogue updates and company info: www.tvh.com

used for: AMEISE-JUNGHEINRICH



VOLTAGE	REMARK	CONTACTOR
24 V		REF 106TA2159
36 V		REF 106TA2160
48 V		REF 106TA2161
72 V		REF 106TA2162
80 V		REF 106TA2163
CONTACT KIT: REF 106TA2366 (order 4x)		

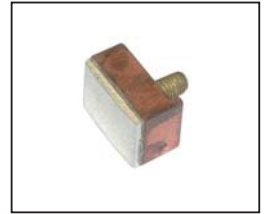

used for: STILL - LINDE



VOLTAGE	REMARK	CONTACTOR
24 V	with copper contacts	REF 107TA8443
48 V	with copper contacts	REF 106TA2170
80 V	with copper contacts	REF 106TA2172
CONTACT KIT: REF 105TA4721 (order 4x)		



used for: STILL - LINDE



VOLTAGE	REMARK	CONTACTOR
24 V	with silver contacts	REF 106TA2169
48 V	with silver contacts	REF 106TA2171
80 V	with silver contacts	REF 106TA2173
CONTACT KIT: REF 105TA4720 (order 4x)		



used for: STILL



VOLTAGE	REMARK	CONTACTOR
12 V		REF 107TA8444
24 V		REF 106TA2174
48 V		REF 106TA2175
80 V		REF 106TA2176
CONTACT KIT: REF 110TA2788 (order 4x)		



used for: LINDE - with blow-outs

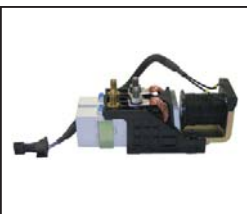

VOLTAGE	REMARK	CONTACTOR
48 V		REF 123TA7167
80 V		REF 123TA7168



used for: LANSING



VOLTAGE	REMARK	CONTACTOR
48 V	3005078	REF 111TA3724
72 V	3005152	REF 111TA3725



For all our latest catalogue updates and company info: www.tvh.com

used for: **FIAT / OM-PIMESPO**

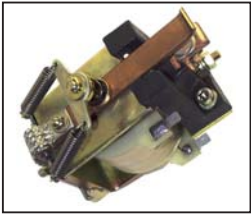

VOLTAGE	REMARK	CONTACTOR
24 V	single pole - normal open	REF 106TA2181
24 V	single pole - change-over	REF 107TA1539



CONTACTORS

For all our latest catalogue updates and company info: www.tvh.com

used for: **AMETEK - HB - PRESTOLITE**

HB111 - 100A



VOLTAGE	REMARK	CONTACTOR
24 V	BT	REF 106TA2234
36 V		REF 135TA1977
CONTACT KIT: REF 106TA2236		



HB117 - 100A



VOLTAGE	REMARK	CONTACTOR
24 V	BT	REF 106TA2237
CONTACT KIT: REF 106TA2239		



HBSP102 - 100A

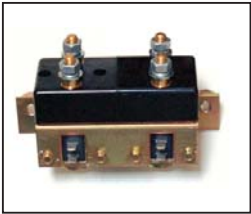

VOLTAGE	REMARK	CONTACTOR
24 V	BT	REF 106TA2240
CONTACT KIT: REF 106TA2241 (2 x)		



HBSP193 - 100A



VOLTAGE	REMARK	CONTACTOR
24 V	LAFIS	REF 107TA1551
CONTACT KIT: REF 106TA2241 (2 x)		



HBSP103 - 100A



VOLTAGE	REMARK	CONTACTOR
24 V	BT / LAFIS	REF 107TA1552
CONTACT KIT: REF 106TA2241 (1 x) + REF 106TA2245 (2 x)		

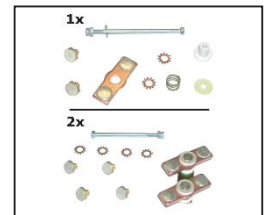

HBSP197 - 100A



VOLTAGE	REMARK	CONTACTOR
24 V		REF 111TA3560
CONTACT KIT: REF 106TA2236 (2 x) + REF 106TA2239 (2 x)		

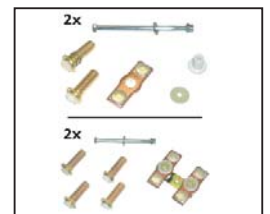

CONTACTORS



For all our latest catalogue updates and company info: www.tvh.com

HBSP182 - 100A



VOLTAGE	REMARK	CONTACTOR
48 V	BT	REF 111TA3561
CONTACT KIT: REF 106TA2245 (2 x)		



HBSP206 - 100A



VOLTAGE	REMARK	CONTACTOR
24 V		REF 111TA3562
CONTACT KIT: REF 106TA2236 (1 x) + REF 106TA2239 (3 x)		

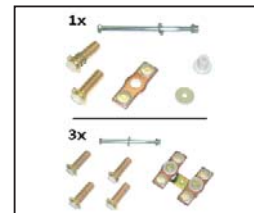

HBSP218 - 100A



VOLTAGE	REMARK	CONTACTOR
	no longer available, please buy contactors separately	
CONTACT KIT: REF 106TA2236 (3 x) + REF 106TA2239 (2 x)		

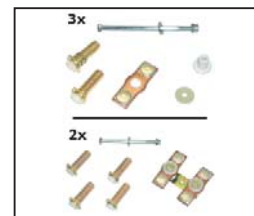

HBSP198 - 100A



VOLTAGE	REMARK	CONTACTOR
24 V	BT	REF 111TA6220
CONTACT KIT: REF 106TA2236 (3 x) + REF 106TA2239 (2 x)		

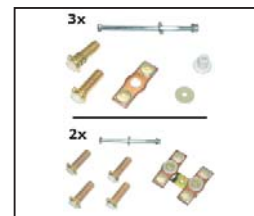

HB401 - 100A



VOLTAGE	REMARK	CONTACTOR
24 V	BT	REF 106TA2252
24 V	LAFIS	REF 106TA2254
CONTACT KIT: REF 110TA3581		

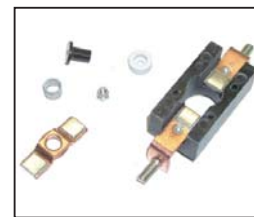

HB401 - 100A



VOLTAGE	REMARK	CONTACTOR
36 V	CAT	REF C399716
CONTACT KIT: REF 110TA3588		



HB403 - 100A



VOLTAGE	REMARK	CONTACTOR
24 V	BT	REF 106TA2248
CONTACT KIT: REF 108TA7988		

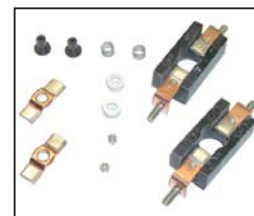



CONTACTORS

For all our latest catalogue updates and company info: www.tvh.com

HB407 - 100A



VOLTAGE	REMARK	CONTACTOR
24 V	BT	REF 106TA2249
48 V	BT	REF 106TA2251

CONTACT KIT: REF [108TA8173](#)

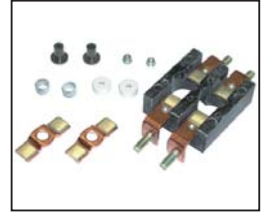

HB407 - 100A



VOLTAGE	REMARK	CONTACTOR
36 V	CAT	REF C399707

CONTACT KIT: REF [108TA7552](#)

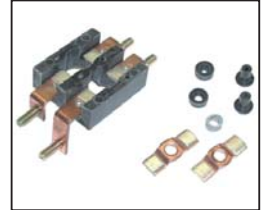

HB409 - 100A



VOLTAGE	REMARK	CONTACTOR
36 V	CAT	REF C399717

CONTACT KIT: REF [108TA8056](#)

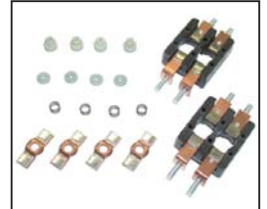

HB431 - 150A



VOLTAGE	REMARK	CONTACTOR
24 V	ATLET	REF 106TA2254
48 V	ATLET	REF 135TA1978

CONTACT KIT: REF [110TA3578](#)



HB431 - 150A



VOLTAGE	REMARK	CONTACTOR
48 V	BT CONT	REF B74453
48 V	BT INT	REF B74451

CONTACT KIT: REF [108TA8249](#)



HB433 - 150A

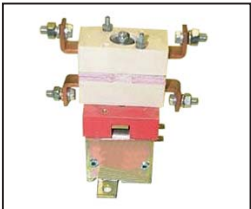

VOLTAGE	REMARK	CONTACTOR
48 V	BT	REF 111TA3568

CONTACT KIT: REF [112TA2907](#)

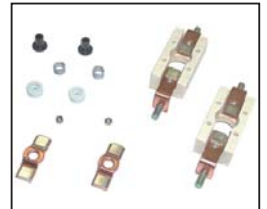

HB437 - 150 AMPS



VOLTAGE	REMARK	CONTACTOR
24 V	BT	REF 106TA2256
48 V	BT	REF 106TA2258

CONTACT KIT: REF [108TA7751](#)

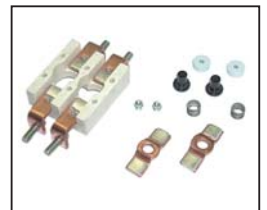

CONTACTORS



For all our latest catalogue updates and company info: www.tvh.com

HB437 - 150 AMPS



VOLTAGE	REMARK	CONTACTOR
48 V	ATLET	REF 106TA2257
CONTACT KIT: REF 105TA4710		

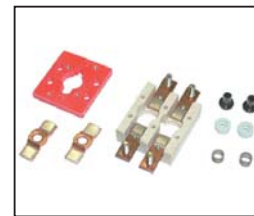

SERIES HB1 - 200A



VOLTAGE	REMARK	CONTACTOR
24 V	BT/ATLET	REF 106TA2259
48 V	ATLET	REF 106TA2262
CONTACT KIT: REF 110TA3569		



SERIES HB1 - 200A

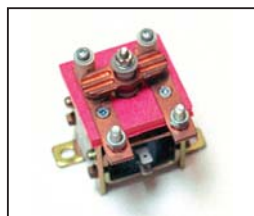

VOLTAGE	REMARK	CONTACTOR
36 V	CAT	REF C386641
36 V	CAT	REF C394391
72 V	CAT	REF C396580
72 V	CAT	REF C396581
CONTACT KIT: REF 110TA3587		

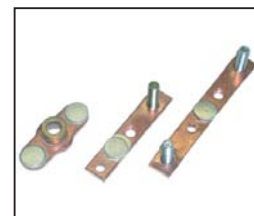

SERIES HB1 - 200A

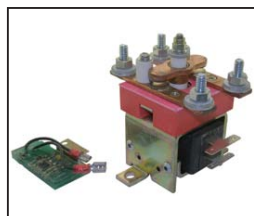

VOLTAGE	REMARK	CONTACTOR
	no longer available, please buy contact kit	
CONTACT KIT: REF 110TA3559		



SERIES HB1 - 200A



VOLTAGE	REMARK	CONTACTOR
36 V	CAT	REF C399712
CONTACT KIT: REF 108TA8063		



SERIES HB1 - 200A

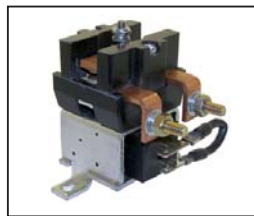

VOLTAGE	REMARK	CONTACTOR
36 V	CAT	REF C924355
36 V	CAT	REF C924356
CONTACT KIT: REF 108TA7549		

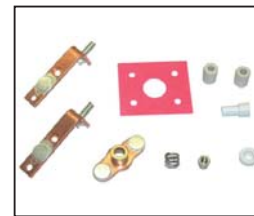

SERIES HB3 - 200A



VOLTAGE	REMARK	CONTACTOR
24 V	YALE	REF 111TA3570
CONTACT KIT: REF 108TA7845		





CONTACTORS

For all our latest catalogue updates and company info: www.tvh.com

SERIES HB30 - 300A

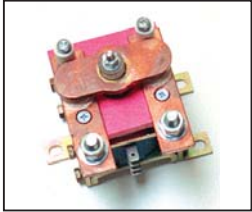

VOLTAGE	REMARK	CONTACTOR
24 V	HYSTER	REF 106TA2271
48 V	CLARK/CAT	REF 106TA2272
CONTACT KIT: REF 108TA7886		

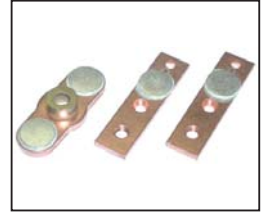

SERIES HB30 - 300A



VOLTAGE	REMARK	CONTACTOR
36 V	CAT	REF C3C7394
72 V	CAT	REF C396582
CONTACT KIT: REF 108TA7902		



SERIES HB30 - 300A



VOLTAGE	REMARK	CONTACTOR
no longer available, please buy contact kit		
CONTACT KIT: REF 111TA4050		



SERIES HB36 - 300A



VOLTAGE	REMARK	CONTACTOR
no longer available, please buy contact kit		
CONTACT KIT: REF 108TA8032		



SERIES HB38 - 300A



VOLTAGE	REMARK	CONTACTOR
no longer available, please buy contact kit		
CONTACT KIT: REF 110TA3591		

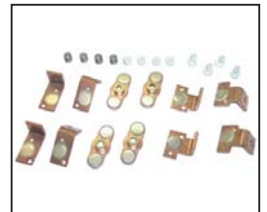

SERIES HB60



VOLTAGE	REMARK	CONTACTOR
36 V		REF 111TA3572
CONTACT KIT: REF 110TA3555		



SERIES HB7 - 200A



VOLTAGE	REMARK	CONTACTOR
24 V	BT	REF 106TA2268
36 V	CAT	REF C914052
36 V	CAT	REF C924667
48 V	BT	REF 122TA7498
CONTACT KIT: REF 108TA7682		

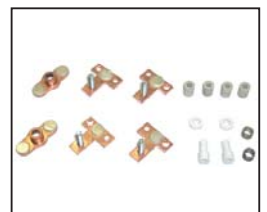



For all our latest catalogue updates and company info: www.tvh.com

SERIES HB70 - 100A

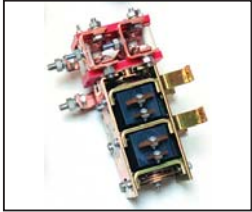

VOLTAGE	REMARK	CONTACTOR
	no longer available, please buy contact kit	
	CONTACT KIT: REF 108TA7837	





CONTACTORS

For all our latest catalogue updates and company info: www.tvh.com

used for: **BALKANCAR**

KPE 4 - 63 AMPS

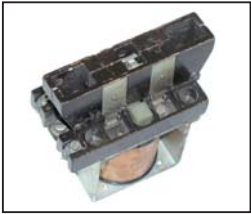

VOLTAGE	REMARK	CONTACTOR
40V	55 Ohm	REF 123TA1932
CONTACT KIT: REF 123TA5758		



KPE 5 - 160 AMPS



VOLTAGE	REMARK	CONTACTOR
40V	52 Ohm	REF 123TA1974
CONTACT KIT: REF 123TA5759		



KPE 6 - 160 AMPS



VOLTAGE	REMARK	CONTACTOR
40V	23 Ohm	REF 123TA7169
CONTACT KIT: REF 123TA5760		



KPD 5 - 100 AMPS



VOLTAGE	REMARK	CONTACTOR
40V	40,7 Ohm	REF 123TA1935
80V	180 Ohm	REF 135TA1975
CONTACT KIT: REF 123TA5759 (2x)		



KPD 6 - 160 AMPS



VOLTAGE	REMARK	CONTACTOR
40V	40,6 Ohm	REF 123TA5757
80V	180 Ohm	REF 135TA1976
CONTACT KIT: REF 123TA5760 (2x)		



CONTACTORS



For all our latest catalogue updates and company info: www.tvh.com

used for: **BOSCH**

SERIES 200 - NORMAL OPEN - 230A



VOLTAGE	REMARK	CONTACTOR
24 V	0333200010 horizontal support mounting	REF 111TA6157
24 V	0333200012 vertical support mounting	REF 111TA6158
48 V	0333200016	REF 111TA6159
80 V	0333200013	REF 111TA6160

CONTACT KIT: REF [110TA3561](#)



SERIES 201 - CHANGE OVER - 230A



VOLTAGE	REMARK	CONTACTOR
24 V	0333201010	REF 111TA6161
24 V	0333201011 auxiliary switch	REF 111TA6162
48 V	0333201015	REF 111TA6163
80 V	0333201012	REF 111TA6164
80 V	0333201013 auxiliary switch	REF 111TA6165

CONTACT KIT: REF [111TA6191](#)



SERIES 007 - SINGLE POLE - NORMAL OPEN - 150A



VOLTAGE	REMARK	CONTACTOR
24 V	0333007002	REF 111TA6166

CONTACT KIT: REF [111TA6167](#)



SERIES 007 - DOUBLE POLE - NORMAL OPEN - 150A

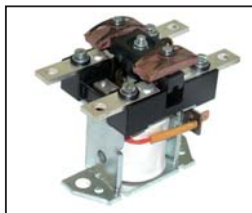

VOLTAGE	REMARK	CONTACTOR
24 V	0333007004	REF 111TA6168

CONTACT KIT: REF [111TA6169](#)

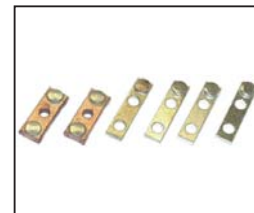

NO = normal open
CO = change over

BOSCH solenoids

POWER RELAYS SERIES 006 - 80A CONT - NO



VOLTAGE	REMARK	SOLENOID
6 V		REF 134TA9152
12 V		REF 106TA2315
24 V		REF 106TA2316

POWER RELAYS SERIES 006 - 80A CONT - 1NO + 1CO



VOLTAGE	REMARK	SOLENOID
12 V		REF 134TA9156



CONTACTORS

For all our latest catalogue updates and company info: www.tvh.com

POWER RELAYS SERIES 006 - 100A CONT - 1NC



VOLTAGE	REMARK	SOLENOID
24 V		REF 134TA9157

POWER RELAYS SERIES 009 - 150A CONT - NO



VOLTAGE	REMARK	SOLENOID
12 V	screw terminal	REF 106TA2317
24 V	screw terminal	REF 116TA4686

POWER RELAYS SERIES 009 - 150A CONT - NO



VOLTAGE	REMARK	SOLENOID
24 V	fast-on terminal	REF 106TA2319

KISSLING solenoids

SERIES 29 - 300A - NO



VOLTAGE	REMARK	SOLENOID
24 V		REF 134TA9153
28 V	diode	REF 125TA4562
48 V		REF 123TA1940



For all our latest catalogue updates and company info: www.tvh.com

ESSEX / WHITE-RODGERS solenoids

TYPE 124 - 100A - SINGLE POLE - NO



VOLTAGE	REMARK	SOLENOID
12 V		REF 107TA1568
24 V		REF 107TA1569
36 V		REF 122TA7508

TYPE 124 - 100A - SINGLE POLE - CO



VOLTAGE	REMARK	SOLENOID
12 V		REF 111TA3727
24 V		REF 107TA1571
36 V		REF 107TA1572
48 V		REF 134TA9154

TYPE 586 - 200A - SINGLE POLE - NO



VOLTAGE	REMARK	SOLENOID
12 V	water resistant	REF 122TA7509
24 V	water resistant	REF 111TA4054
36 V	water resistant	REF 122TA7510
48 V	water resistant	REF 123TA9532

TYPE 586 - 200A - SINGLE POLE - CO



VOLTAGE	REMARK	SOLENOID
24 V	water resistant	REF 122TA7511
36 V	water resistant	REF 111TA4055

TYPE 120 - 100A



VOLTAGE	REMARK	SOLENOID
12 V	water resistant - high vibration resistant	REF 122TA7512
24 V	water resistant - high vibration resistant	REF 115TA6891
36 V	water resistant - high vibration resistant	REF 111TA4056

RAVIOLI solenoids - equivalent to BOSCH

SERIES T106 - 80A - NO



VOLTAGE	REMARK	SOLENOID
12 V	fast-on terminal	REF 122TA7516
24 V	fast-on terminal	REF 122TA7501



CONTACTORS

For all our latest catalogue updates and company info: www.tvh.com

SERIES T106 - 80A - CO



VOLTAGE	REMARK	SOLENOID
12 V	fast-on terminal	REF 122TA7504
24 V	fast-on terminal	REF 122TA7505
36 V	fast-on terminal	REF 122TA7506

SERIES T156 - 100A - NO



VOLTAGE	REMARK	SOLENOID
12 V	fast-on terminal	REF 111TA3714
24 V	fast-on terminal	REF 134TA9155

SERIES T154 - 100A - NO



VOLTAGE	REMARK	SOLENOID
12 V	screw terminal	REF 111TA4052
24 V	screw terminal	REF 111TA4053
36 V	screw terminal	REF 122TA7507

SERIES T206 - 150A - NO



VOLTAGE	REMARK	SOLENOID
12 V	fast-on terminal	REF 122TA7502
24 V	fast-on terminal	REF 122TA7503

SERIES T204 - 150A - NO



VOLTAGE	REMARK	SOLENOID
12 V	screw terminal	REF 107TA1564
24 V	screw terminal	REF 107TA1565

UNIVERSAL solenoids - equivalent to BOSCH

- = CURVED BRACKET
- = STANDARD BRACKET

SOLENOID 140A - DOUBLE POLE - 1NO + 1NC



VOLTAGE	REMARK	SOLENOID
12 V		REF 107TA1570

CONTACTORS



For all our latest catalogue updates and company info: www.tvh.com

SOLENOID 120A - DOUBLE POLE - 1NO + 1NC



VOLTAGE	REMARK	SOLENOID
24 V		REF 107TA1563

BEST BUY - 150A - NO



VOLTAGE	REMARK	SOLENOID
24 V		REF 106TA2325

used for HPI



VOLTAGE	REMARK	SOLENOID
12 V	80 A	REF 125TA4563
12 V	150 A	REF 134TA8202
24 V	80 A curved bracket	REF 125TA4565
24 V	150 A curved bracket	REF 125TA4564

used for BT, PRAMAC, ICEM



VOLTAGE	REMARK	SOLENOID
12 V		REF 125TA4566

used for SAZ 4201 DUY MARINE



VOLTAGE	REMARK	SOLENOID
12 V		REF 125TA4567

SOLENOIDS used for TOYOTA





VOLTAGE	REMARK	SOLENOID
12 V		REF 125TA4558
24 V		REF 125TA4559
48 V		REF 125TA4560



CONTACTORS

For all our latest catalogue updates and company info: www.tvh.com

UNIVERSAL SMALL SIZE SOLENOIDS

 = CURVED BRACKET
 = STANDARD BRACKET

SOLENOID - 3 TERMINALS - COPPER CONTACTS - 80 A



VOLTAGE	REMARK	SOLENOID
12 V	intermittent duty - curved bracket	REF 106TA2334
12 V	intermittent duty - standard bracket	REF 123TA7733
12 V	continuous duty - standard bracket	REF 106TA2333
24 V	intermittent duty - standard bracket	REF 123TA7734

SOLENOID - 3 TERMINALS - SILVER CONTACTS - 150 A



VOLTAGE	REMARK	SOLENOID
12 V	continuous duty - curved bracket	REF 106TA2335

SOLENOID - 4 TERMINALS - COPPER CONTACTS - 80 A



VOLTAGE	REMARK	SOLENOID
12 V	continuous duty - standard bracket	REF 106TA2336

SOLENOID - 4 TERMINALS - SILVER CONTACTS - 150 A



VOLTAGE	REMARK	SOLENOID
12 V	150 A continuous duty - standard bracket	REF 106TA2337
24 V	100 A continuous duty - standard bracket	REF 106TA2338
24 V	100 A continuous duty - curved bracket	REF 107TA1566
36 V	60 A continuous duty - standard bracket	REF 106TA2340
48 V	60 A continuous duty - standard bracket	REF 122TA7499
72 V	60 A continuous duty - stand-offs	REF 107TA1567

SOLENOID - 6 TERMINALS - 80 A



VOLTAGE	REMARK	SOLENOID
12 V		REF 123TA5764
24 V		REF 123TA5765

ECONOMICAL VERSION - 80 A



VOLTAGE	REMARK	SOLENOID
12 V	intermittent duty - 3 terminals	REF 111TA3726
12 V	intermittent duty - 4 terminals	REF 123TA5763

CONTACTORS



For all our latest catalogue updates and company info: www.tvh.com

MAC 15D - 150 A



VOLTAGE	REMARK	SOLENOID
12 V		REF 125TA4561
24 V		REF 123TA1937
CONTACT KIT: REF 115TA5501		



MAC 15R - 150 A



VOLTAGE	REMARK	SOLENOID
12 V		REF 123TA1938
24 V		REF 123TA1939
CONTACT KIT: REF 122TA7677		





CONTACTORS

For all our latest catalogue updates and company info: www.tvh.com

used for: **CABLEFORM - series 1000**

SERIES 1000 - SINGLE POLE - NORMAL OPEN - 200A



VOLTAGE	REMARK	CONTACTOR
12 V		REF 103TA1556
24 V		REF 103TA1557
36 V		REF 103TA1558
48 V		REF 103TA1559
72 V		REF 111TA3528
CONTACT KIT: REF 105TA4712		

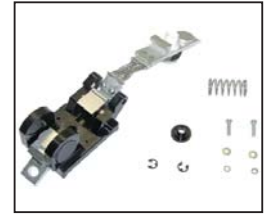

SERIES 1000 - DOUBLE POLE - CHANGE OVER - 200A



VOLTAGE	REMARK	CONTACTOR
24 V		REF 103TA1567
48 V		REF 103TA1568
72 V		REF 103TA1569
CONTACT KIT: REF 103TA1570		

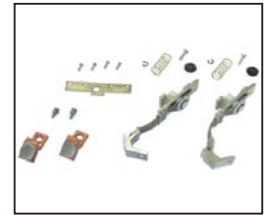

used for: **CABLEFORM - series 1100**

SERIES 1100 - SINGLE POLE - NORMAL OPEN - 200A

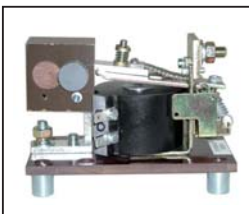

VOLTAGE	REMARK	CONTACTOR
24 V		REF 103TA1580
48 V		REF 103TA1581
72 V		REF 103TA1582
80 V		REF 103TA1583
CONTACT KIT: REF 108TA7874		

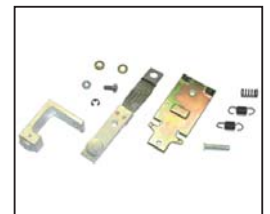

SERIES 1100 - SINGLE POLE - CHANGE OVER - 200A



VOLTAGE	REMARK	CONTACTOR
24 V		REF 111TA3529
48 V		REF 103TA1603
72 V	without panel	REF 111TA3530
CONTACT KIT: REF 103TA1604		



SERIES 1100 - DOUBLE POLE - CHANGE OVER - 200A

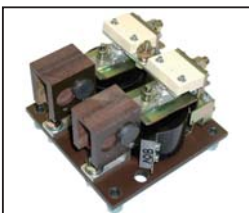

VOLTAGE	REMARK	CONTACTOR
24 V		REF 111TA3531
48 V		REF 103TA1613
72 V		REF 111TA3532
80 V		REF 108TA4148
CONTACT KIT: REF 108TA7931		

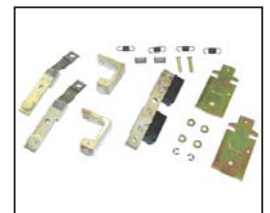

used for: **CABLEFORM - series 1200**

SERIES 1200 - SINGLE POLE - NORMAL OPEN - 300A



VOLTAGE	REMARK	CONTACTOR
72 V		REF 135TA1983
CONTACT KIT: REF 135TA2447		



CONTACTORS



For all our latest catalogue updates and company info: www.tvh.com

used for: **CABLEFORM - series 1300**

SERIES 1300 - SINGLE POLE - NORMAL OPEN - 120A



VOLTAGE	REMARK	CONTACTOR
12 V		REF 103TA1618
24 V		REF 103TA1619
24 V	with diode	REF 111TA3533
36 V		REF 111TA3534
48 V		REF 111TA3535
48 V	with diode	REF 103TA1624
72 V		REF 103TA1622



CONTACT KIT: REF [135TA1982](#)

SERIES 1300 - SINGLE POLE - CHANGE OVER - 120A



VOLTAGE	REMARK	CONTACTOR
12 V		REF 103TA1641
24 V		REF 103TA1642
24 V	with diode	REF 111TA3536
36 V		REF 111TA3537
48 V		REF 103TA1644
48 V	with diode	REF 111TA3538
72 V		REF 103TA1645



CONTACT KIT: REF [110TA3567](#)

used for: **CABLEFORM - series 1400**

SERIES 1400 - SINGLE POLE - NORMAL OPEN - 250A



VOLTAGE	REMARK	CONTACTOR
12 V		REF 103TA1509
24 V		REF 111TA3539
36 V		REF 103TA1511
48 V		REF 103TA1512
72 V		REF 103TA1513
80 V		REF 111TA3540



CONTACT KIT: REF [108TA8167](#)

SERIES 1400 - SINGLE POLE - CHANGE OVER - 250A



VOLTAGE	REMARK	CONTACTOR
24 V		REF 103TA1539
36 V		REF 111TA3541
48 V		REF 111TA3542
72 V		REF 111TA3543
80 V		REF 103TA1543



CONTACT KIT: REF [108TA8164](#)



CONTACTORS

For all our latest catalogue updates and company info: www.tvh.com

used for: **GENERAL ELECTRIC - SERIES IC4482CTRA - EV1**

EV1 150A - SINGLE POLE - NORMAL OPEN - Config. AH



VOLTAGE	REMARK	CONTACTOR
12 V	CTRA 700	REF 107TA1468
24 V	CTRA 700	REF 106TA2021
36 V	CTRA 700	REF 107TA1469
36/48 V	CTRA 700	REF 107TA1470
48 V	CTRA 700	REF 107TA1471
72/80 V	CTRA 710 ARCSHIELDS	REF 107TA1472

CONTACT KIT: REF [106TA2026](#)

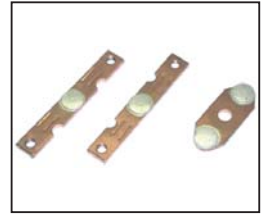

EV1 300A - SINGLE POLE - NORMAL OPEN - Config. AH



VOLTAGE	REMARK	CONTACTOR
24 V	CTRA 800	REF 111TA3552
36 V	CTRA 800	REF 111TA3553
36/48 V	CTRA 800	REF 111TA3554
48 V	CTRA 800	REF 106TA2030
72/80 V	CTRA 810 ARCSHIELDS	REF 107TA1475
36/48 V	CTRA 800 CONT	REF 106TA2029

CONTACT KIT: REF [107TA1476](#)

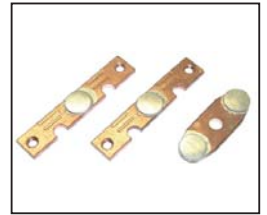

EV1 150A - SINGLE POLE - NORMAL OPEN - Config. AA



VOLTAGE	REMARK	CONTACTOR
36 V	CTRA 700	REF 107TA1477
36/48 V	CTRA 700	REF 111TA3555
72/80 V	CTRA 700	REF 106TA2035
36/48 V	CTRA 700 CONT	REF 107TA1478

CONTACT KIT: REF [107TA1479](#)



EV1 300A - SINGLE POLE - NORMAL OPEN - Config. AA



VOLTAGE	REMARK	CONTACTOR
36 V	CTRA 800	REF 107TA1480
36/48 V	CTRA 800	REF 111TA3556
36/48 V	CTRA 800 ARCSHIELDS	REF 115TA1830
72/80 V	CTRA 800	REF 107TA1482
36/48 V	CTRA 800 CONT	REF 107TA1481

CONTACT KIT: REF [107TA1483](#)



EV1 150A - CHANGE OVER - Config. BB

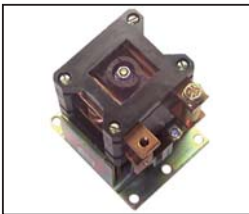

VOLTAGE	REMARK	CONTACTOR
36/48 V	CTRA 701	REF 106TA2041
72/80 V	CTRA 701	REF 135TA2422

CONTACT KIT: REF [108TA7561](#)



EV1 300A - CHANGE OVER - Config. BB



VOLTAGE	REMARK	CONTACTOR
36 V	CTRA 802	REF 116TA7799
36/48 V	CTRA 802	REF 135TA2424

CONTACT KIT: REF [135TA2423](#)



CONTACTORS



For all our latest catalogue updates and company info: www.tvh.com

EV1 150A - CHANGE OVER - Config. BC



VOLTAGE	REMARK	CONTACTOR
24 V	CTRA 702 HEAVY-DUTY	REF 122TA7495
36 V	CTRA 701	REF 111TA3557

CONTACT KIT: REF [135TA2425](#)



EV1 300A - CHANGE OVER - Config. BC



VOLTAGE	REMARK	CONTACTOR
36 V	CTRA 802	REF 116TA7800
36/48 V	CTRA 802	REF 135TA2426

CONTACT KIT: REF [135TA2427](#)



EV1 150A - CHANGE OVER - Config. BD

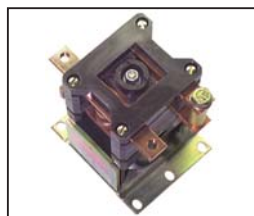

VOLTAGE	REMARK	CONTACTOR
24 V	CTRA 701	REF 106TA2043
36 V	CTRA 701	REF 107TA1485
36/48 V	CTRA 701	REF 106TA2045
72/80 V	CTRA 711 ARCSHIELDS	REF 106TA2046

CONTACT KIT: REF [107TA1486](#)



EV1 150A - CHANGE OVER - Config. BD - HEAVY DUTY

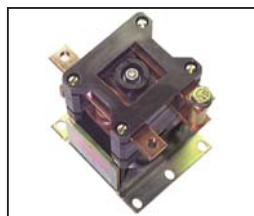

VOLTAGE	REMARK	CONTACTOR
24 V	CTRA 702 HEAVY-DUTY	REF 135TA1988
36 V	CTRA 702 HEAVY-DUTY	REF 135TA1989

CONTACT KIT: REF [107TA1487](#)



EV1 300A - CHANGE OVER - Config. BD - HEAVY DUTY



VOLTAGE	REMARK	CONTACTOR
72/80 V	CTRA 812 ARCSHIELDS / HEAVY-DUTY	REF 111TA3558

CONTACT KIT: REF [107TA1490](#)



EV1 300A - CHANGE OVER - Config. BD



VOLTAGE	REMARK	CONTACTOR
24 V	CTRA 801	REF 135TA2445
36 V	CTRA 801	REF 135TA2446

CONTACT KIT: REF [107TA1488](#)



EV1 150A - CHANGE OVER - Config. BE



VOLTAGE	REMARK	CONTACTOR
24 V	CTRA 701	REF 106TA2052
36 V	CTRA 701	REF 135TA2428
36/48 V	CTRA 701	REF 107TA1491
72/80 V	CTRA 711 ARCSHIELDS	REF 107TA1492

CONTACT KIT: REF [106TA2055](#)





CONTACTORS

For all our latest catalogue updates and company info: www.tvh.com

EV1 150A - CHANGE OVER - Config. BE - HEAVY DUTY



VOLTAGE	REMARK	CONTACTOR
24 V	CTRA 702 HEAVY-DUTY	REF 122TA7496
36 V	CTRA 702 HEAVY-DUTY	REF 135TA2429
36/48 V	CTRA 702 HEAVY-DUTY	REF 135TA2430
CONTACT KIT: REF 110TA3574		



EV1 300A - CHANGE OVER - Config. BE



VOLTAGE	REMARK	CONTACTOR
24 V	CTRA 801	REF 135TA1987
36/48 V	CTRA 801	REF 107TA1494
CONTACT KIT: REF 107TA1493		

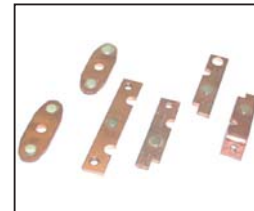

EV1 300A - CHANGE OVER - Config. BE - HEAVY DUTY



VOLTAGE	REMARK	CONTACTOR
36/48 V	CTRA 812 ARCSHIELDS / HEAVY-DUTY	REF 135TA2431
72/80 V	CTRA 812 ARCSHIELDS / HEAVY-DUTY	REF 106TA2057
CONTACT KIT: REF 107TA1495		



used for: **GENERAL ELECTRIC - SERIES IC4482CTTA - EV100**

EV100 100A - SINGLE POLE - NORMAL OPEN - Config. AH



VOLTAGE	REMARK	CONTACTOR
24 V	CTTA 100 INT	REF 107TA1498
24 V	CTTA 100 CONT	REF 111TA3559
36 V	CTTA 100 INT	REF 135TA2432
36/48 V	CTTA 100	REF 135TA2433
48 V	CTTA 100 CONT	REF 107TA1497
72/80 V	CTTA 100	REF 107TA1496
CONTACT KIT: REF 107TA1499		

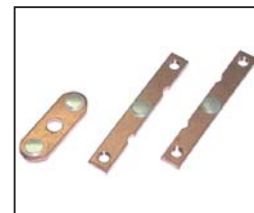

EV100 150A - SINGLE POLE - NORMAL OPEN - Config. AH



VOLTAGE	REMARK	CONTACTOR
12 V	CTTA 150 INT	REF 135TA2434
24 V	CTTA 150 INT	REF 107TA1502
24 V	CTTA 150 ARCSHIELDS / INT	REF 106TA2064
24 V	CTTA 150 SPECIAL	REF 106TA2068
36 V	CTTA 150 INT	REF 107TA1500
36/48 V	CTTA 150	REF 106TA2066
72/80 V	CTTA 150	REF 135TA2435
72/80 V	CTTA 150 ARCSHIELDS	REF 107TA1501
CONTACT KIT: REF 106TA2071		



EV100 300A - SINGLE POLE - NORMAL OPEN - Config. AH



VOLTAGE	REMARK	CONTACTOR
24 V	CTTA 300	REF 107TA1503
24 V	CTTA 300 ARCSHIELDS	REF 107TA1504
36 V	CTTA 300 INT	REF 135TA2436
36/48 V	CTTA 300	REF 107TA1505
36/48 V	CTTA 300 ARCSHIELDS	REF 135TA2437
72/80 V	CTTA 300	REF 106TA2074
72/80 V	CTTA 300 ARCSHIELDS	REF 106TA2075
CONTACT KIT: REF 106TA2077		



CONTACTORS



For all our latest catalogue updates and company info: www.tvh.com

EV100 100A - SINGLE POLE - NORMAL OPEN - Config. AA



VOLTAGE	REMARK	CONTACTOR
24 V	CTTA 100 INT	REF 107TA1506
36/48 V	CTTA 100	REF 115TA1831
72/80 V	CTTA 100	REF 135TA2439
CONTACT KIT: REF 107TA1507		



EV100 150A - SINGLE POLE - NORMAL OPEN - Config. AA



VOLTAGE	REMARK	CONTACTOR
24 V	CTTA 150	REF 107TA1508
36 V	CTTA 150 INT	REF 135TA2438
36/48 V	CTTA 150	REF 107TA1509
CONTACT KIT: REF 108TA8009		



EV100 300A - SINGLE POLE - NORMAL OPEN - Config. AA



VOLTAGE	REMARK	CONTACTOR
24 V	CTTA 300 INT	REF 107TA1510
36/48 V	CTTA 300	REF 106TA2083
48 V	CTTA 300 CONT	REF 135TA2441
72/80 V	CTTA 300	REF 135TA2440
CONTACT KIT: REF 110TA3617		



EV100 100A - CHANGE OVER (MOTOR REVERSING) - Config. FR



VOLTAGE	REMARK	CONTACTOR
24 V	CTTA 104 INT	REF 107TA1511
36 V	CTTA 104 INT	REF 135TA2442
CONTACT KIT: REF 107TA1512		

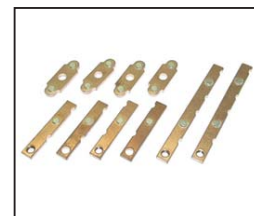

EV100 150A - CHANGE OVER (MOTOR REVERSING) - Config. FR

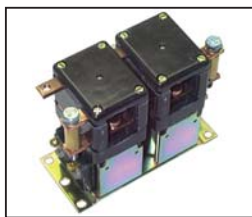

VOLTAGE	REMARK	CONTACTOR
24 V	CTTA 154 INT	REF 106TA2086
36 V	CTTA 154 INT	REF 135TA2443
36/48 V	CTTA 154	REF 106TA2088
72/80 V	CTTA 154	REF 106TA2089
CONTACT KIT: REF 106TA2091		

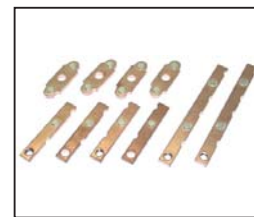

EV100 160A - CHANGE OVER (MOTOR REVERSING) - Config. FR



VOLTAGE	REMARK	CONTACTOR
24 V	CTTA 158	REF 106TA2090
CONTACT KIT: REF 107TA1513		

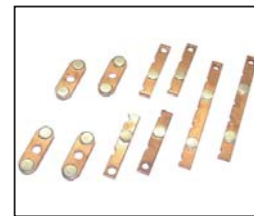

EV100 300A - CHANGE OVER (MOTOR REVERSING) - Config. FR



VOLTAGE	REMARK	CONTACTOR
24 V	CTTA 304 INT	REF 106TA2093
36/48 V	CTTA 304	REF 106TA2094
72/80 V	CTTA 304	REF 106TA2095
72/80 V	CTTA 304 ARCSHIELDS	REF 135TA2444
24	CTTA 304 CONT	REF 107TA1514
CONTACT KIT: REF 106TA2097		

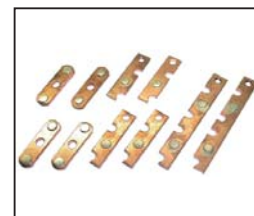



CONTACTORS

For all our latest catalogue updates and company info: www.tvh.com

used for: **GENERAL ELECTRIC - SERIES IC2800M**

IC2800 M610



VOLTAGE	REMARK	CONTACTOR
12 V		REF 107TA8597
24 V		REF 107TA8598
36 V	CONT	REF 107TA8599

IC2800 M611 AE



VOLTAGE	REMARK	CONTACTOR
12 V		REF 107TA8600
24 V		REF 107TA8601

IC2800 M611 AD



VOLTAGE	REMARK	CONTACTOR
12 V		REF 107TA8602
12 V	with aux. switch	REF 107TA8603
24 V		REF 107TA8604

CONTACTORS



For all our latest catalogue updates and company info: www.tvh.com

used for: **HARDELLET - SERIES 20000 - 100A**



C20000 - SINGLE POLE - 100A



VOLTAGE	REMARK	CONTACTOR
12 V	STANDARD BRACKET	REF 106TA2295
24 V	STANDARD BRACKET	REF 106TA2296
24 V	ALBRIGHT TYPE BRACKET	REF 111TA3544

CONTACT KIT: REF [106TA2281](#)



DP20000 - DOUBLE POLE - 100A



VOLTAGE	REMARK	CONTACTOR
24 V	STANDARD BRACKET	REF 106TA2298
24 V	ALBRIGHT TYPE BRACKET	REF 111TA3545

CONTACT KIT: REF [106TA2282](#)



BDP20000 - MOTOR REVERSER - 100A



VOLTAGE	REMARK	CONTACTOR
24 V	STANDARD BRACKET	REF 111TA3546
24 V	ALBRIGHT TYPE BRACKET	REF 111TA3547

CONTACT KIT: REF [106TA2282](#) (2x)



used for: **HARDELLET - SERIES MURENE - 200A**

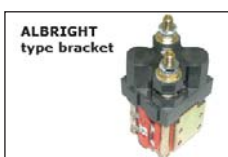

C1200 - SINGLE POLE - 200A



VOLTAGE	REMARK	CONTACTOR
24 V	STANDARD BRACKET	REF 107TA1556
24 V	ALBRIGHT TYPE BRACKET	REF 111TA3548

CONTACT KIT: REF [106TA2279](#)



DP2200 - DOUBLE POLE - 200A



VOLTAGE	REMARK	CONTACTOR
24 V	STANDARD BRACKET	REF 107TA1557
24 V	ALBRIGHT TYPE BRACKET	REF 111TA3549

CONTACT KIT: REF [107TA1555](#)





CONTACTORS

For all our latest catalogue updates and company info: www.tvh.com

BDP2200 - MOTOR REVERSER - 200A



VOLTAGE	REMARK	CONTACTOR
24 V	STANDARD BRACKET	REF 111TA3550
24 V	ALBRIGHT TYPE BRACKET	REF 111TA3551
CONTACT KIT: REF 107TA1555 (2x)		



used for: **HARDELLET - SERIES 24000**

SINGLE POLE - NORMAL OPEN - 100A

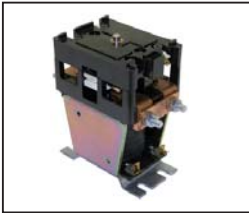

VOLTAGE	REMARK	CONTACTOR
no longer available, please buy contact kit		
CONTACT KIT: REF 106TA2288		

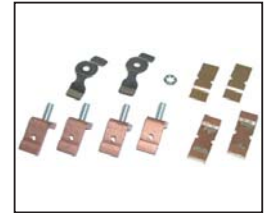

SINGLE POLE - NORMAL OPEN - 150A



VOLTAGE	REMARK	CONTACTOR
no longer available, please buy contact kit		
CONTACT KIT: REF 106TA2287		



SINGLE POLE - CHANGE OVER - 150A



VOLTAGE	REMARK	CONTACTOR
no longer available, please buy contact kit		
CONTACT KIT: REF 106TA2290		



SINGLE POLE - NORMAL OPEN - 350A



VOLTAGE	REMARK	CONTACTOR
no longer available, please buy contact kit		
CONTACT KIT: REF 106TA2291		

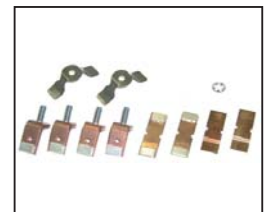

SINGLE POLE - CHANGE OVER - 350A



VOLTAGE	REMARK	CONTACTOR
no longer available, please buy contact kit		
CONTACT KIT: REF 106TA2292		

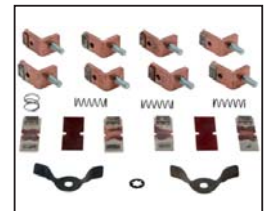

CONTACTORS



For all our latest catalogue updates and company info: www.tvh.com

JAPANESE CONTACTORS used for: MEIDEN

MA11 - CHANGE OVER - 150A



VOLTAGE	REMARK	CONTACTOR
46 V	used for TOYOTA	REF 106TA2347
CONTACT KIT: REF 111TA3716		



MA20 - NORMAL OPEN - 150A



VOLTAGE	REMARK	CONTACTOR
46 V	used for TOYOTA	REF 106TA2348
CONTACT KIT: REF 111TA3717		



MA22 - NORMAL OPEN - 150A



VOLTAGE	REMARK	CONTACTOR
46 V	used for TOYOTA	REF 106TA2349
CONTACT KIT: REF 111TA3718		



ME 251 - NORMAL OPEN



VOLTAGE	REMARK	CONTACTOR
36 V		REF 123TA1941
CONTACT KIT: REF 123TA1942		



ME 250 - CHANGE OVER



VOLTAGE	REMARK	CONTACTOR
36 V		REF 123TA1943
CONTACT KIT: REF 123TA1944		



MZ11A - CHANGE OVER - 150A



VOLTAGE	REMARK	CONTACTOR
24 V	used for TOYOTA	REF 135TA1980
34 V	used for TOYOTA	REF 135TA1981
46 V	used for TOYOTA	REF 107TA1573
CONTACT KIT: REF 115TA1843		





CONTACTORS

For all our latest catalogue updates and company info: www.tvh.com

MX160BC - NORMAL OPEN - 280A



VOLTAGE	REMARK	CONTACTOR
48 V	used for TOYOTA	REF 107TA1574
CONTACT KIT: REF 115TA1844		



MY 11 M1 - CHANGE OVER - 100A



VOLTAGE	REMARK	CONTACTOR
48 V		REF 123TA1945
CONTACT KIT: REF 116TA6991		



JAPANESE CONTACTORS used for: KYORITSU KEIKI

CM16T - SHORT - NORMAL OPEN



VOLTAGE	REMARK	CONTACTOR
46 V	used for TOYOTA	REF 108TA4149
CONTACT KIT: REF 122TA7513		



CM16T - PUMP - NORMAL OPEN



VOLTAGE	REMARK	CONTACTOR
46 V	used for TOYOTA	REF 108TA4150
CONTACT KIT: REF 122TA7514		



CM16T - DRIVE - CHANGE OVER



VOLTAGE	REMARK	CONTACTOR
46 V	used for TOYOTA	REF 107TA1575
CONTACT KIT: REF 122TA7515		



CM16A - NORMAL OPEN



VOLTAGE	REMARK	CONTACTOR
48 V	used for KOMATSU	REF 108TA4151
CONTACT KIT: REF 108TA8018		



CONTACTORS



For all our latest catalogue updates and company info: www.tvh.com

CM16TC - CHANGE OVER



VOLTAGE	REMARK	CONTACTOR
48 V	used for KOMATSU	REF 108TA4152
CONTACT KIT: REF 108TA8019		



CM16H - NORMAL OPEN



VOLTAGE	REMARK	CONTACTOR
36/48 V	used for NISSAN	REF 107TA1577
72/80 V	used for NISSAN	REF 111TA6192
CONTACT KIT: REF 108TA8018		



CM16H - CHANGE OVER



VOLTAGE	REMARK	CONTACTOR
36/48 V	used for NISSAN	REF 107TA1576
72/80 V	used for NISSAN	REF 111TA6193
CONTACT KIT: REF 108TA8019		



GO31 - NORMAL OPEN



VOLTAGE	REMARK	CONTACTOR
48 V	used for KOMATSU	REF 107TA1585
CONTACT KIT: REF 111TA3737		



GN05 - NORMAL OPEN



VOLTAGE	REMARK	CONTACTOR
80 V	used for NISSAN	REF 116TA5561
CONTACT KIT: REF 111TA3737		



GN03 - NORMAL OPEN



VOLTAGE	REMARK	CONTACTOR
48 V	used for TOYOTA / KOMATSU	REF 108TA4156
CONTACT KIT: REF 111TA3740		



GO5 - NORMAL OPEN



VOLTAGE	REMARK	CONTACTOR
48 V	used for NISSAN / TCM	REF 111TA3738
72/80 V	used for NISSAN	REF 116TA5560
CONTACT KIT: REF 111TA3739		





CONTACTORS

For all our latest catalogue updates and company info: www.tvh.com

CM2 - NORMAL OPEN



VOLTAGE	REMARK	CONTACTOR
48 V	used for KOMATSU	REF 123TA1946
CONTACT KIT: REF 123TA1947		



PN18 - A



VOLTAGE	REMARK	CONTACTOR
48 V	used for KOMATSU	REF 123TA1948
CONTACT KIT: REF 123TA1949		



PA15

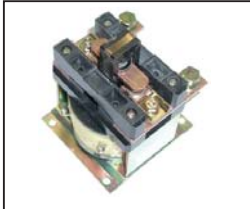

VOLTAGE	REMARK	CONTACTOR
48 V	used for KOMATSU	REF 123TA1950
CONTACT KIT: REF 123TA1951		



PN12 - TC



VOLTAGE	REMARK	CONTACTOR
48 V	used for KOMATSU	REF 123TA1952
CONTACT KIT: REF 123TA1953		



JAPANESE CONTACTORS used for: NYK-NICHI YU

MS3 SERIES - NORMAL OPEN



VOLTAGE	REMARK	CONTACTOR
24 V	MS3200	REF 111TA3719
48 V	MS3400	REF 107TA1578
48 V	MS3420	REF 123TA7644
CONTACT KIT: REF 111TA3720		



MS3 SERIES - CHANGE OVER

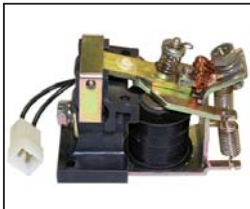

VOLTAGE	REMARK	CONTACTOR
24 V	MS3203	REF 116TA5559
48 V	MS3403	REF 107TA1579
48 V	MS3423	REF 123TA7645
CONTACT KIT: REF 111TA3721		



CONTACTORS



For all our latest catalogue updates and company info: www.tvh.com

MS3 SERIES - CHANGE OVER - FORWARD REVERSE ASSEMBLY



VOLTAGE	REMARK	CONTACTOR
48 V	MS3403	REF 107TA1580
48 V	MS3423	REF 123TA7646
CONTACT KIT: REF 111TA3722		



MS9- SERIES - NORMAL OPEN



VOLTAGE	REMARK	CONTACTOR
48 V		REF 107TA1581
CONTACT KIT: REF 111TA3723		



JAPANESE CONTACTORS used for: HITACHI

Contact connections



NORMAL OPEN - coil height: 36 mm



VOLTAGE	REMARK	CONTACTOR
24 V	15 Ohm (eccentric connections) white tape - used for NISSAN	REF 108TA4153
48 V	66 Ohm (eccentric connections) red tape - used for TCM	REF 111TA3731
CONTACT KIT: REF 111TA3728		

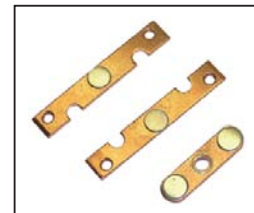

NORMAL OPEN - coil height: 48 mm

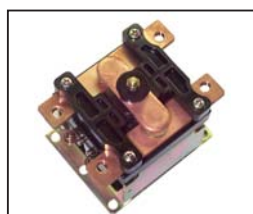

VOLTAGE	REMARK	CONTACTOR
48 V	66 Ohm (eccentric connections) white tape - used for NISSAN	REF 111TA3730
48 V	66 Ohm (eccentric connections) red tape - used for TCM	REF 115TA6892
CONTACT KIT: REF 111TA3728		

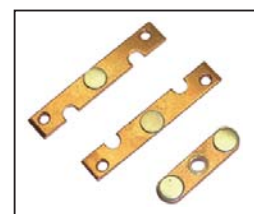

NORMAL OPEN - coil height: 48 mm

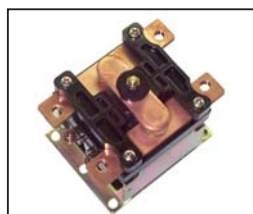

VOLTAGE	REMARK	CONTACTOR
48 V	66 Ohm (middle connections) yellow tape - used for TCM	REF 111TA3732
CONTACT KIT: REF 111TA3729		



NORMAL CLOSED



VOLTAGE	REMARK	CONTACTOR
48 V	66 Ohm (middle connections) yellow tape - used for TCM	REF 108TA4158
CONTACT KIT: REF 111TA3733		





CONTACTORS

For all our latest catalogue updates and company info: www.tvh.com

CHANGE OVER - coil height: 36 mm



VOLTAGE	REMARK	CONTACTOR
24 V	15 Ohm (eccentric connections) white tape - used for NISSAN	REF 108TA4154
CONTACT KIT: REF 111TA3734		

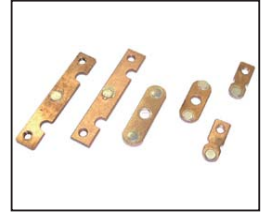

CHANGE OVER - coil height: 48 mm

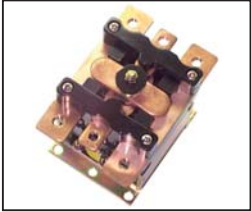

VOLTAGE	REMARK	CONTACTOR
48 V	66 Ohm (eccentric connections) white tape - used for NISSAN	REF 108TA4155
48 V	66 Ohm (eccentric connections) red tape - used for TCM	REF 115TA6893
CONTACT KIT: REF 111TA3734		

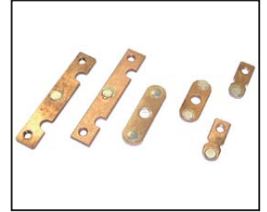

CHANGE OVER - coil height: 48 mm

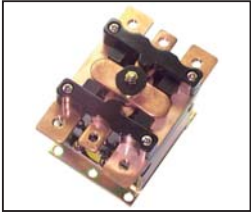

VOLTAGE	REMARK	CONTACTOR
48 V	66 Ohm (middle connections) yellow tape - used for TCM	REF 111TA3736
CONTACT KIT: REF 111TA3735		



CONTACTORS



For all our latest catalogue updates and company info: www.tvh.com

used for: **SCHALTBAU**

S137 - NO - 50A



VOLTAGE	REMARK	CONTACTOR
24 V		REF 106TA2099
48 V		REF 106TA2100
80 V		REF 106TA2101
CONTACT KIT: REF 110TA3570		



S137 - CO - 50A



VOLTAGE	REMARK	CONTACTOR
24 V		REF 106TA2102
CONTACT KIT: REF 110TA3604		

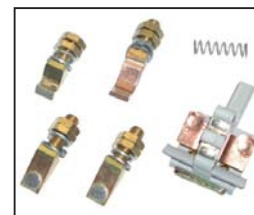

S163 - NO - 100A



VOLTAGE	REMARK	CONTACTOR
24 V		REF 106TA2110
48 V		REF 106TA2111
80 V		REF 106TA2112
CONTACT KIT: REF 108TA7659		

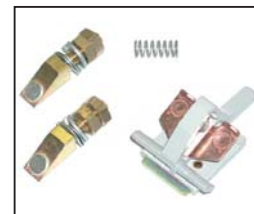

S163 - CO - 100A



VOLTAGE	REMARK	CONTACTOR
24 V		REF 106TA2114
CONTACT KIT: REF 110TA3611		



S164 - NO - 140A



VOLTAGE	REMARK	CONTACTOR
24 V		REF 106TA2116
48 V		REF 107TA1519
80 V		REF 106TA2118
CONTACT KIT: REF 108TA7757		



S164 - CO - 140A



VOLTAGE	REMARK	CONTACTOR
24 V		REF 106TA2122
48 V		REF 106TA2123
80 V		REF 106TA2124
CONTACT KIT: REF 108TA8182		

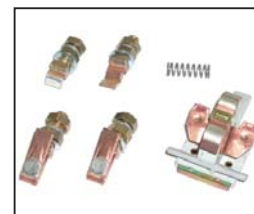



CONTACTORS

For all our latest catalogue updates and company info: www.tvh.com

S165 - NO - 220A



VOLTAGE	REMARK	CONTACTOR
24 V		REF 106TA2126
48 V		REF 107TA1521
80 V		REF 107TA1522
CONTACT KIT: REF 110TA3641		

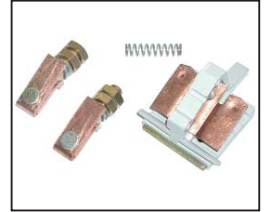

S165 - CO - 220A



VOLTAGE	REMARK	CONTACTOR
24 V		REF 107TA1524
80 V		REF 107TA1525
CONTACT KIT: REF 110TA3615		



S195 - NO - 260A



VOLTAGE	REMARK	CONTACTOR
24 V		REF 107TA1533
48 V		REF 107TA1534
80 V		REF 106TA2148
CONTACT KIT: REF 108TA8109		



S195 - CO - 260A

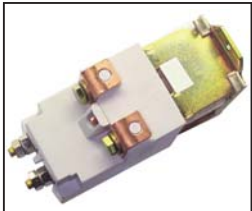

VOLTAGE	REMARK	CONTACTOR
24 V		REF 106TA2149
48 V		REF 107TA1535
CONTACT KIT: REF 110TA3623		



S187A10 - 160A

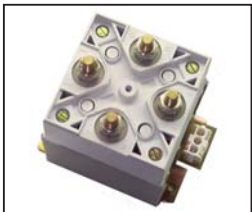

VOLTAGE	REMARK	CONTACTOR
80 V		REF 107TA1530
CONTACT KIT: REF 111TA1881		



S187A17 - 160A



VOLTAGE	REMARK	CONTACTOR
24 V		REF 106TA2139
48 V		REF 107TA1531
CONTACT KIT: REF 111TA1877		



S187A21 - 160A



VOLTAGE	REMARK	CONTACTOR
48 V		REF 106TA2141
CONTACT KIT: REF 111TA1878		



CONTACTORS



For all our latest catalogue updates and company info: www.tvh.com

S187A28 - 160A

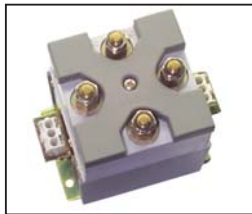

VOLTAGE	REMARK	CONTACTOR
24 V		REF 106TA2142
48 V		REF 106TA2143
80 V		REF 106TA2144
CONTACT KIT: REF 111TA1878		



S187A29 - 160A



VOLTAGE	REMARK	CONTACTOR
24 V	CONT	REF 108TA4146
80 V	CONT	REF 107TA1532
CONTACT KIT: REF 111TA1878		



S167 - 125A



VOLTAGE	REMARK	CONTACTOR
24 V		REF 106TA2132
CONTACT KIT: REF 107TA1526		



S127



VOLTAGE	REMARK	CONTACTOR
		REF 106TA2158

S152

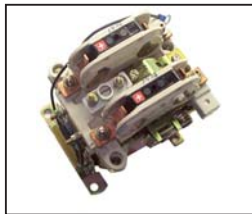

VOLTAGE	REMARK	CONTACTOR
24 V		REF 107TA1538

S152M

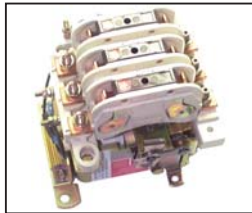

VOLTAGE	REMARK	CONTACTOR
24 V		REF 106TA2157

S168



VOLTAGE	REMARK	CONTACTOR
24 V		REF 106TA2134



CONTACTORS

For all our latest catalogue updates and company info: www.tvh.com

used for: **TELEMECANIQUE OR AMELEC**

used for: TELEMECANIQUE - single pole - NO



VOLTAGE	REMARK	CONTACTOR
12 V		REF 106TA2200
24 V		REF 106TA2201
36 V		REF 106TA2202
48 V		REF 106TA2203
72 V		REF 106TA2204
CONTACT KIT: REF 106TA2193		



used for: TELEMECANIQUE - double pole - NO



VOLTAGE	REMARK	CONTACTOR
24 V		REF 106TA2205
36 V		REF 107TA1542
48 V		REF 106TA2207
CONTACT KIT: REF 107TA1540		
CONTACT KIT for original TELEMECANIQUE: REF 106TA2208		

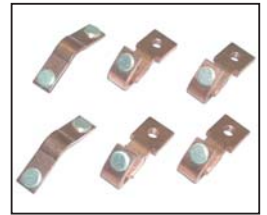

used for: FENWICK - single pole - NO



VOLTAGE	REMARK	CONTACTOR
12 V	F3.025.937 2 screws on coil	REF 106TA2326
24 V	F3.043.471 2 screws on coil	REF 106TA2327
24 V	F3.304.368 1 screw on coil + earth	REF 106TA2328
CONTACT KIT: REF 106TA2329		



used for: FENWICK - double pole - 1NO + 1NC



VOLTAGE	REMARK	CONTACTOR
24 V	F3.043.484 NO-NC 2 screws on coil	REF 106TA2330
24 V	F3.304.365 NO-NC 1 screw on coil + earth	REF 106TA2331
CONTACT KIT: REF 106TA2332		



CONTACTORS MOULDED - Large types: single pole - NO



VOLTAGE	REMARK	CONTACTOR
24 V		REF 106TA2186
36 V		REF 106TA2187
CONTACT KIT: REF 106TA2183 + REF 106TA2184		

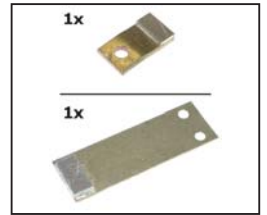

CONTACTORS MOULDED - Large types: double pole - NO



VOLTAGE	REMARK	CONTACTOR
24 V		REF 106TA2188
CONTACT KIT: 2x REF 106TA2183 + 2x REF 106TA2184		

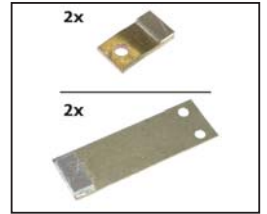

CONTACTORS



For all our latest catalogue updates and company info: www.tvh.com

CONTACTORS MOULDED - Large types: double pole - CO



VOLTAGE	REMARK	CONTACTOR
24 V	length: 165 mm, width: 95 mm	REF 106TA2190
36 V	length: 165 mm, width: 95 mm	REF 106TA2191

CONTACT KIT: 2x REF [106TA2183](#) + REF [106TA2185](#) + 4x REF [106TA2184](#)

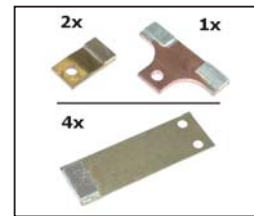

CONTACTORS MOULDED - Small type: single pole - NO



VOLTAGE	REMARK	CONTACTOR
24 V	length: 115 mm, width: 46 mm	REF 106TA2192

CONTACT KIT: REF [110TA8464](#) + REF [110TA8358](#)



CONTACTORS WITH OPEN COILS - single pole - NO



VOLTAGE	REMARK	CONTACTOR
24 V		REF 106TA2230
36 V		REF 106TA2231

CONTACT KIT: REF [106TA2217](#) + REF [106TA2218](#)

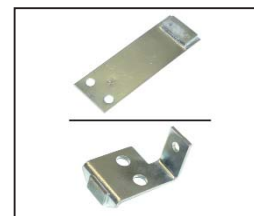

CONTACTORS WITH OPEN COILS - single pole - CO

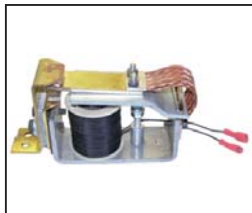

VOLTAGE	REMARK	CONTACTOR
24 V		REF 106TA2232
36 V		REF 106TA2233

CONTACT KIT: 2x REF [106TA2219](#) + REF [106TA2220](#) + REF [106TA2221](#)





CONTACTORS

For all our latest catalogue updates and company info: www.tvh.com

used for: **UNELEC**

SERIES MAC1 - NORMAL OPEN - 180A



VOLTAGE	REMARK	CONTACTOR
12 V	length: 113 mm	REF 111TA6170
24 V	length: 113 mm	REF 111TA6171
36 V	length: 113 mm	REF 111TA6172
48 V	length: 113 mm	REF 111TA6173
80 V	length: 113 mm	REF 116TA5558

CONTACT KIT: REF [108TA7634](#)



SERIES MAC1 - CHANGE OVER - 180A



VOLTAGE	REMARK	CONTACTOR
12 V	length: 113 mm	REF 111TA6174
24 V	length: 113 mm	REF 111TA6175
36 V	length: 113 mm	REF 111TA6176
48 V	length: 113 mm	REF 111TA6177
80 V	length: 113 mm	REF 111TA6178

CONTACT KIT: REF [108TA7621](#)



SERIES MAC2 - NORMAL OPEN - 240A



VOLTAGE	REMARK	CONTACTOR
12 V	length: 134 mm	REF 111TA6179
24 V	length: 134 mm	REF 111TA6180
36 V	length: 134 mm	REF 111TA6181
48 V	length: 134 mm	REF 111TA6182
80 V	length: 134 mm	REF 111TA6183

CONTACT KIT: REF [110TA6775](#)



SERIES MAC2 - CHANGE OVER - 240A



VOLTAGE	REMARK	CONTACTOR
12 V	length: 134 mm	REF 111TA6184
24 V	length: 134 mm	REF 111TA6185
36 V	length: 134 mm	REF 111TA6186
48 V	length: 134 mm	REF 111TA6187
80 V	length: 134 mm	REF 111TA6188

CONTACT KIT: REF [110TA3595](#)

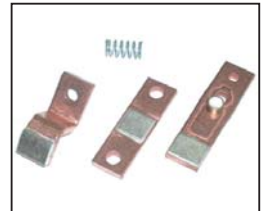



TOTALSOURCE[®]

Look up
these parts via

PS ProductSearch

Part: 2 CONTACTS & CONTACT KITS

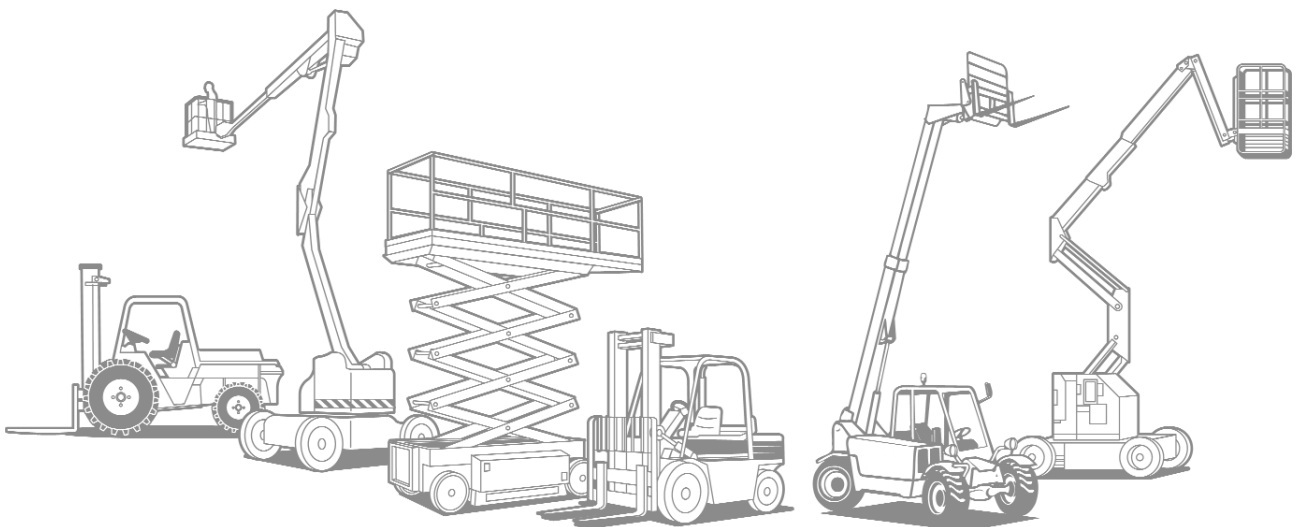



Technische fiche
CONTACT CONTACTOR



02-01-02-00



gegevens klant:

Type machine:
Serie nr. machine:

- prijsaanvraag
 bestelling

CODE:	TY-CT x AT-GA x AT-PL x AT-TI x AT-CT x L x L2 x L3 x D1 x D2 x B x TA x INC x MERK x TY-CR
--------------	---

- TY-CT Type contact:
Fixed.
Fixed assy.
Fixed back.
Moving.
Moving assy.
Special.
Stud.
Tip.
- .. AT-GA Aantal gaten.
- .. AT-PL Aantal plooiën.
- .. AT-TI Aantal tips.
- .. AT-TC Aantal contacten.
- L Totale lengte van het contact (mm).
- L2 Breedte van de tip (mm).
- L3 Lengte van de tip (mm).
- D1 diameter van de tip (mm)
- D2 Diameter kleinste gat (mm).
- B Totale breedte (mm).
- TA Draadsoort, indien aanwezig.
- . INC Inclusief:
V = veer. Bij combinatie van meerdere worden deze in
P = plastic. volgorde geplaatst.
H = hardware. Vb.: PH = plastic en hardware.
- MERK Merk van de contactor.
- TY-CR Type contactor.





AFMETINGEN

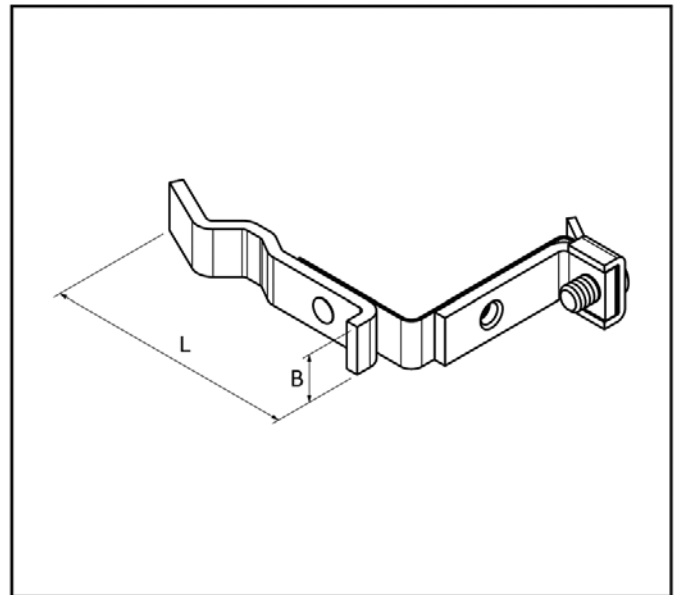
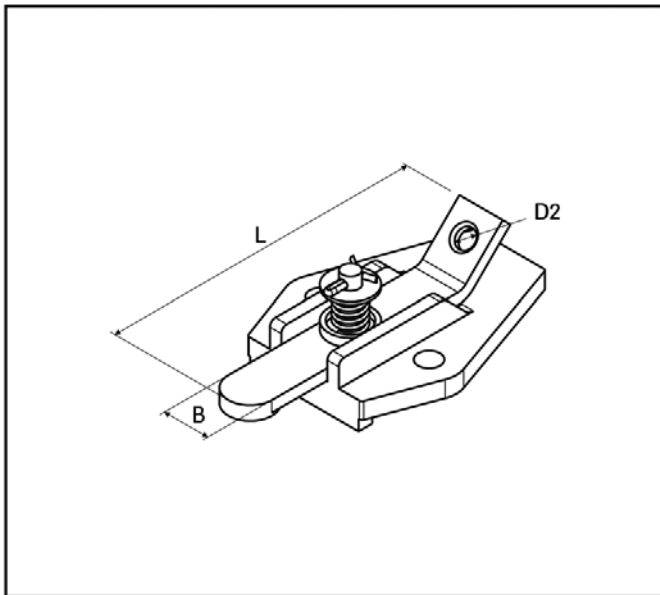
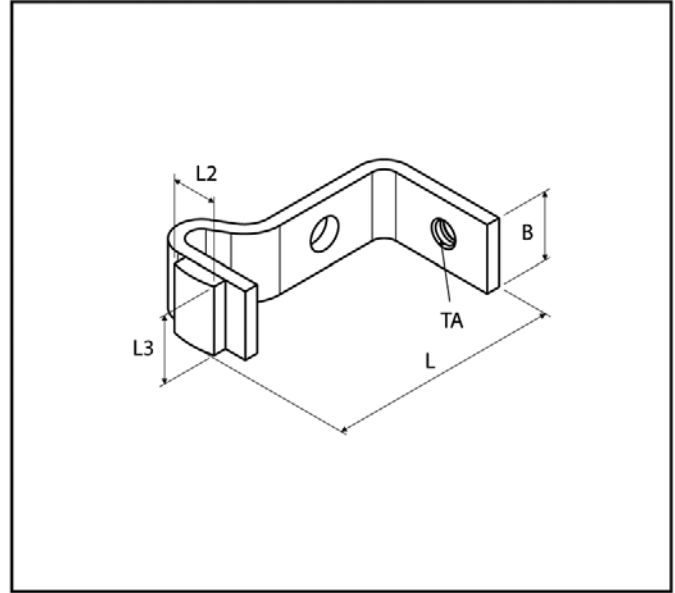
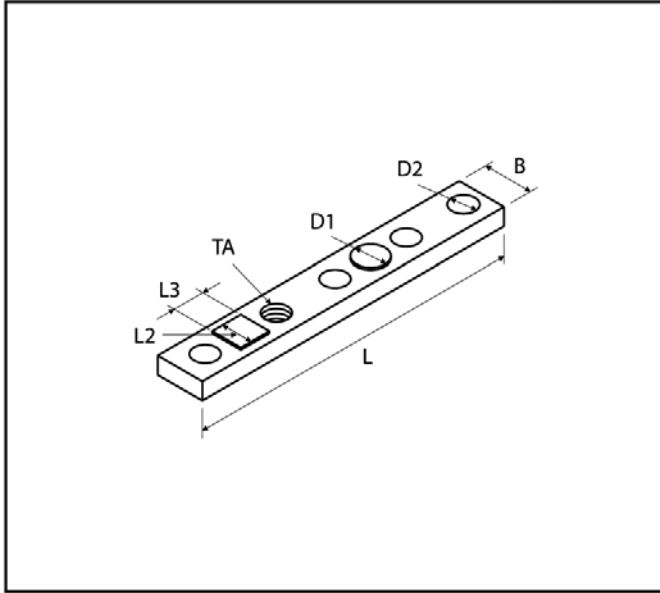



CONTACTS

For all our latest catalogue updates and company info: www.tvh.com



Fiche technique CONTACT DE CONTACTEUR



02-01-02-00



nom de votre société:

Type machine:
 No. série machine:

demande de prix
 commande

CODE : TY-CT x AT-GA x AT-PL x AT-TI x AT-CT x L x L2 x L3 x D1 x D2 x B x TA x INC x MERK x TY-CR

.....

..

..

..

..

.....

.....

.....

.....

.....

.....

.....

.....

.....

.....

.....

.....

.....

.....

.....

.....

.....

- TY-CT Type de contact :
 - Fixed.
 - Fixed assy.
 - Fixed back.
 - Moving.
 - Moving assy.
 - Special.
 - Stud.
 - Tip.
- AT-GA..... Nombre de trous.
- AT-PL Nombre de plis.
- AT-TI..... Nombre de pastilles.
- AT-TC Nombre de contacts.
- L..... Longueur totale du contact (mm).
- L2..... Largeur de la pastille du contact (mm).
- L3..... Longueur de la pastille du contact (mm).
- D1 Diamètre de la pastille du contact (mm).
- D2 Diamètre du plus petit trou (mm).
- B..... Largeur totale (mm).
- TA Type de filetage, si présent.
- INC..... Inclusif :
 - V = ressort.
 - P = plastic.
 - H = hardware.
- MERK Marque du contacteur.
- TY-CR Type contacteur.

En cas de combinaison de plusieurs, nous les mettons par ordre.
 p.ex. : PH = plastic et hardware.





DIMENSIONS

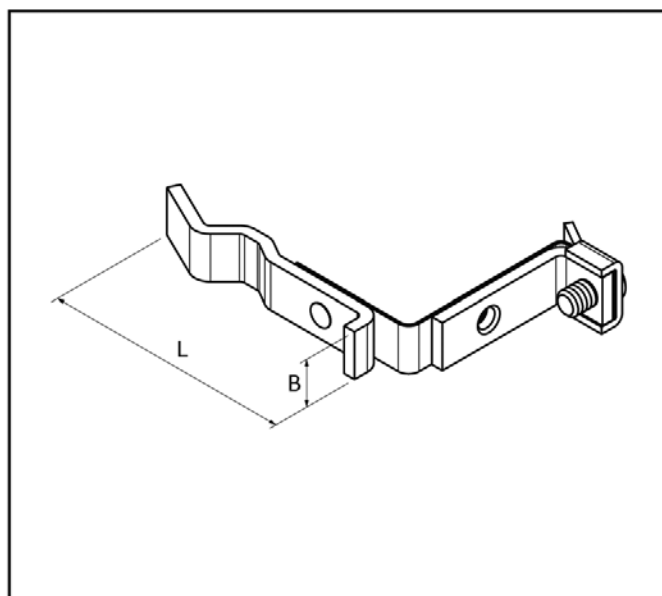
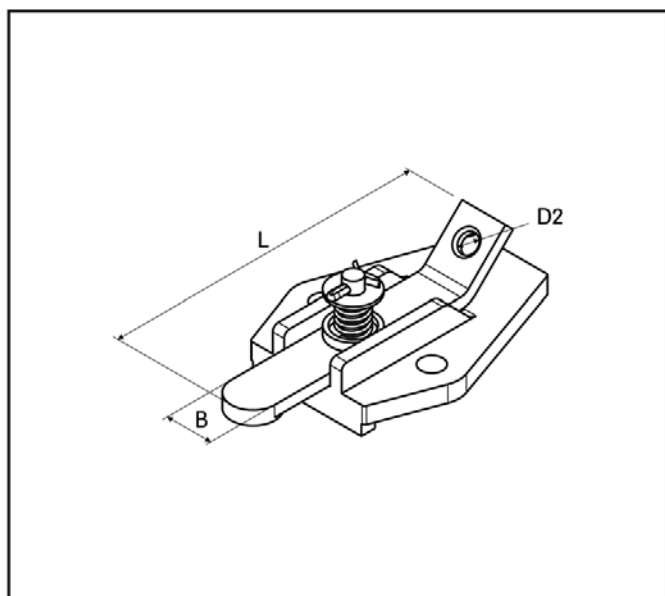
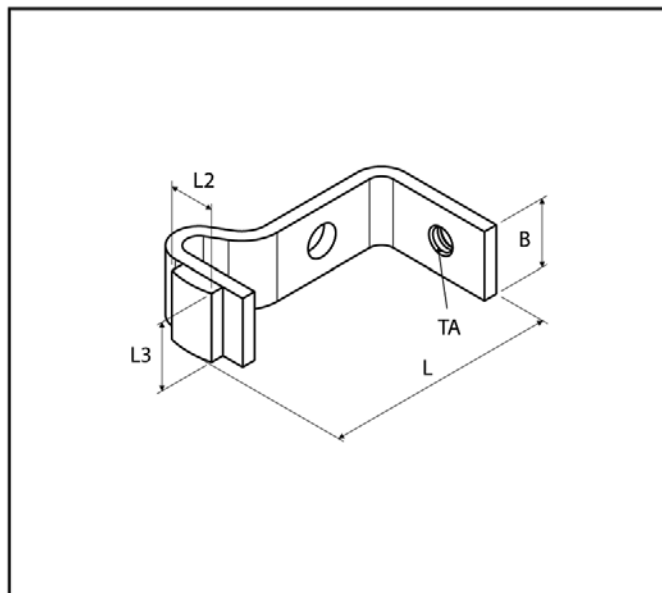
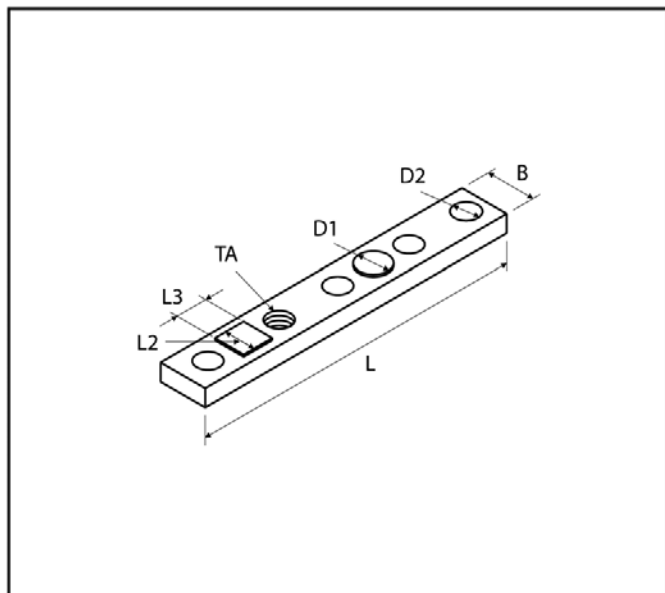



Technical detail
CONTACT CONTACTOR

02-01-02-00



example

customer details:



Truck type:
 Truck serial no.:

inquiry
 order

CODE: TY-CT x AT-GA x AT-PL x AT-TI x AT-CT x L x L2 x L3 x D1 x D2 x B x TA x INC x MERK x TY-CR

.....		TY-CT Type of contact:
..		AT-GA Number of holes.
..		AT-PL Number of curves.
..		AT-TI Number of tips.
..		AT-TC Number of contacts.
.....		L Total length of contact (mm).
.....		L2 Width of tip (mm).
.....		L3 Length of tip (mm).
.,.,.		D1 Diameter of contact tip (mm).
.,.,.		D2 Diameter of the smallest hole (mm).
.,.,.		B Total width (mm).
.....		TA Thread type, if any.
.		INC Included:
.....		MERK Contactor brand.
.....		TY-CR Contactor type.

TY-CT Type of contact:

- Fixed.*
- Fixed assy.*
- Fixed back.*
- Moving.*
- Moving assy.*
- Special.*
- Stud.*
- Tip.*

AT-GA Number of holes.

AT-PL Number of curves.

AT-TI Number of tips.

AT-TC Number of contacts.

L Total length of contact (mm).

L2 Width of tip (mm).

L3 Length of tip (mm).

D1 Diameter of contact tip (mm).

D2 Diameter of the smallest hole (mm).

B Total width (mm).

TA Thread type, if any.

INC Included:

- V = spring.*
- P = plastic.*
- H = hardware.*

When combination, we put them in order.
 E.g.: PH = plastic and hardware.

MERK Contactor brand.

TY-CR Contactor type.



DIMENSIONS

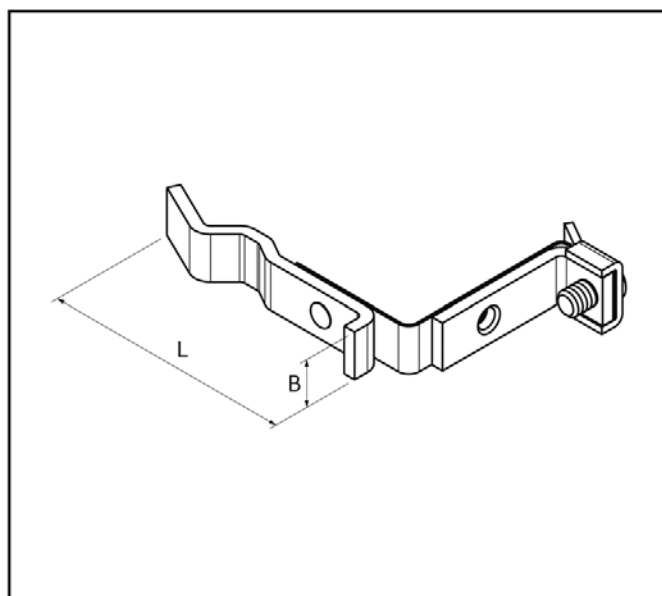
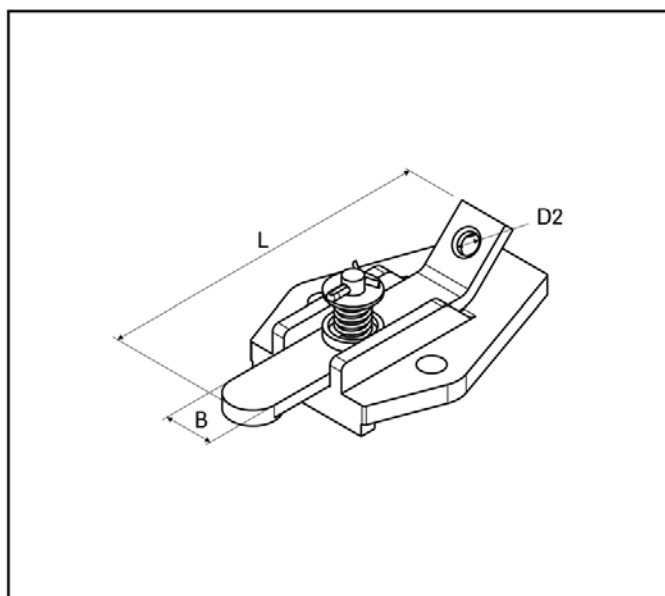
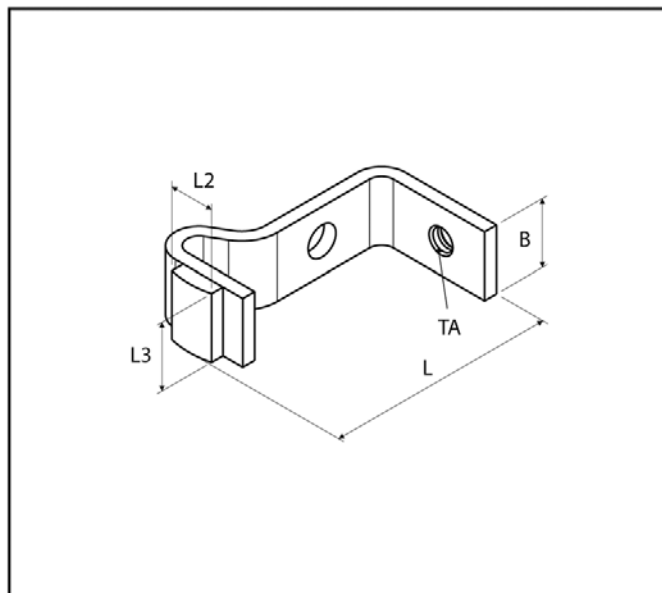
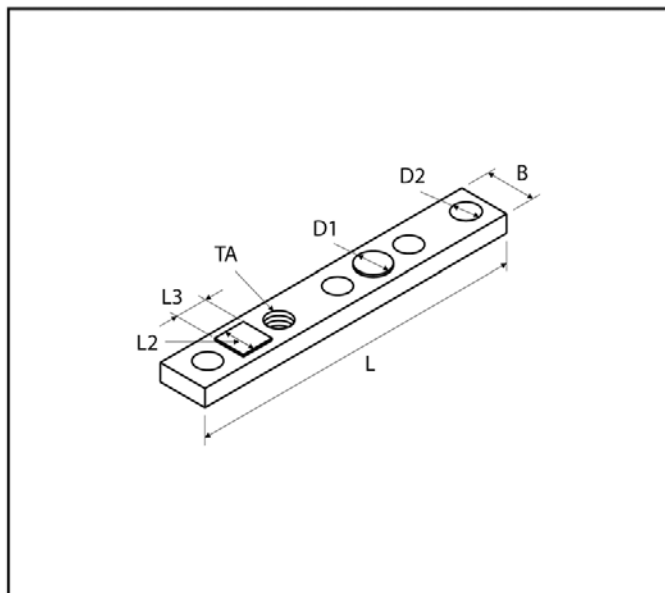



Technische Daten RELAISKONTAKTE

02-01-02-00



Beispiel

Kundendaten:

Maschinentyp:
Maschine Seriennr.:

Preisanfrage
 Bestellung

CODE: TY-CT x AT-GA x AT-PL x AT-TI x AT-CT x L x L2 x L3 x D1 x D2 x B x TA x INC x MERK x TY-CR

.....
..
..
..
..
.....
.....
.....
.....
.....
.....
.....
.....
.....
.....
.....
.....
.....
.....
.....
.....
.....
.....
.....

TY-CT Kontakttyp:
Fixed.
Fixed assy.
Fixed back.
Moving.
Moving assy.
Special.
Stud.
Tip.
AT-GA..... Löcherzahl.
AT-PL Rillenzahl.
AT-TI..... Faltenzahl.
AT-TC Anzahl Kontakte.
L..... Gesamtlänge des Kontaktes (mm).
L2..... Breite der Kontaktspitze (mm).
L3..... Länge der Kontaktspitze (mm).
D1 Kontaktspitzendurchmesser (mm).
D2 Durchmesser des kleinsten Loches (mm).
B..... Gesamtbreite (mm).
TA Gewindetyp, wenn vorhanden.
INC..... Inklusive:
V = Feder. Bei Kombination von mehreren Kontakten, diese
P = Plastik. in Reihenfolge anordnen.
H = Hardware. Z.B. PH = Plastik und Hardware.
MERK Relaismarke.
TY-CR Relaisstyp.





ABMESSUNGEN

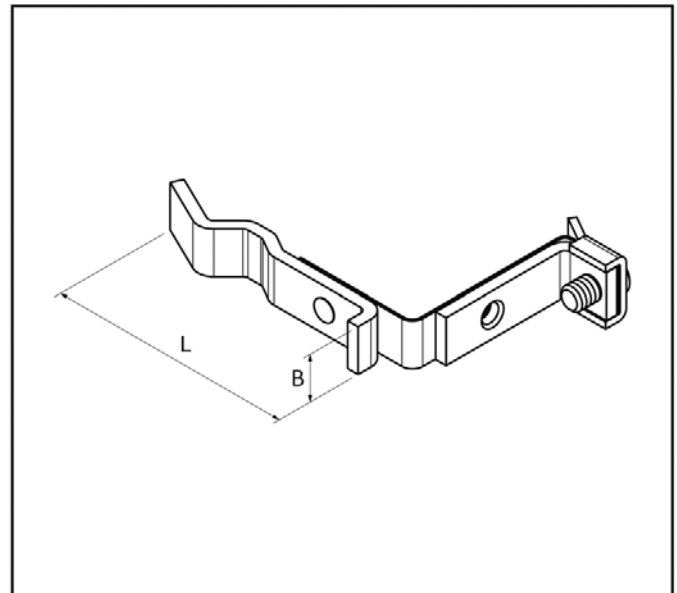
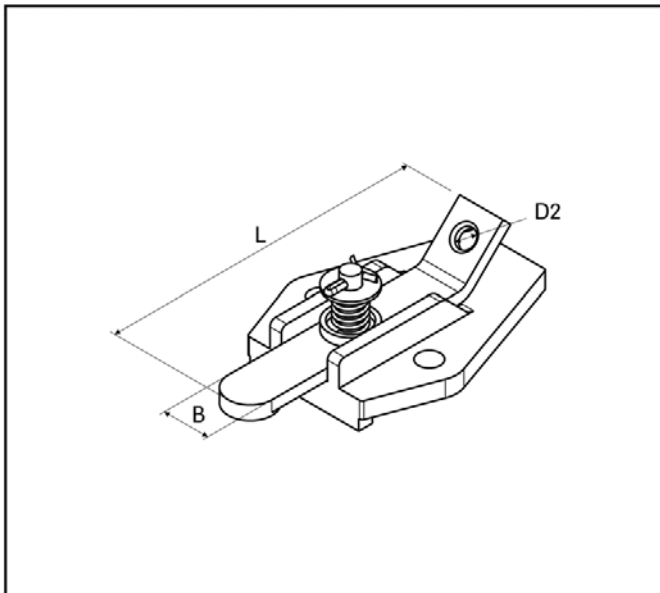
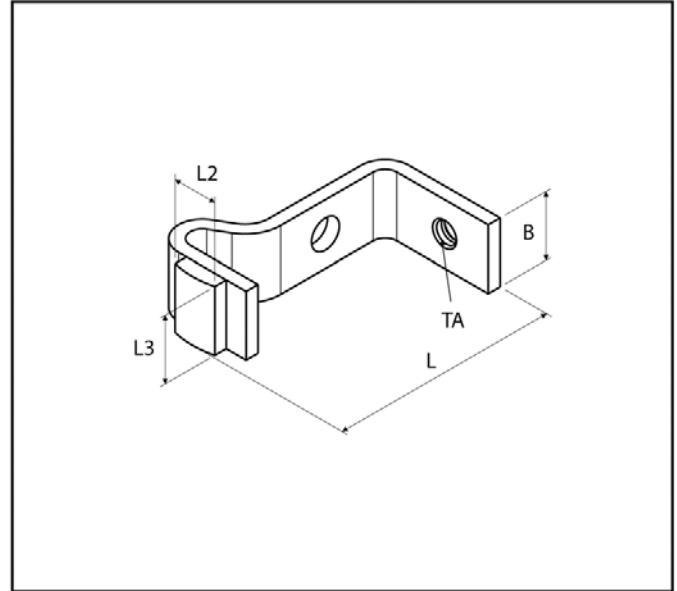
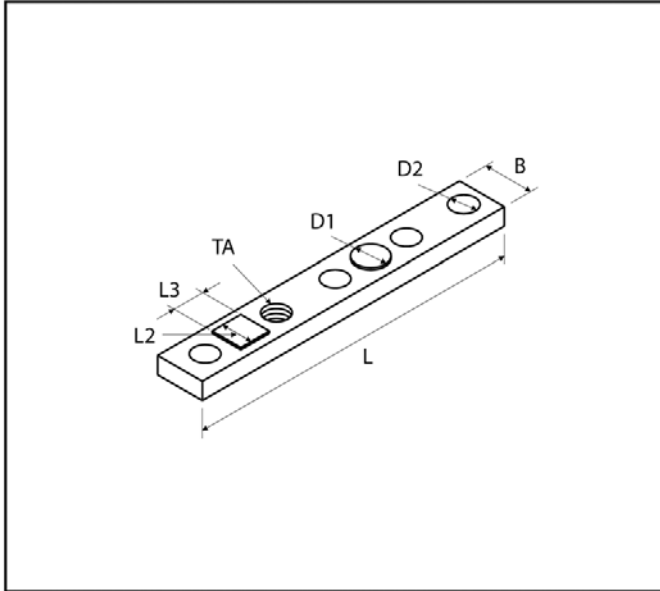



Technische fiche CONTACT KIT CONTACTOR

02-01-02-01

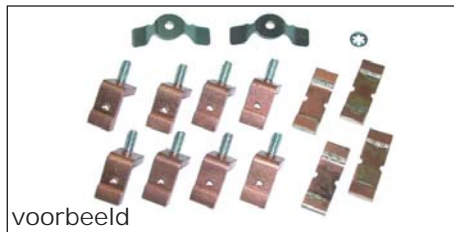

voorbeeld

gegevens klant:



Type machine:
Serie nr. machine:

prijsaanvraag
 bestelling

Code: AT-CT x D x L1 x L2 x AT-TI x AT-PL x MERK x TY-CR

.. AT-CT .. aantal contacten

.... D diameter van de grootste tip

.... L1 kleinste afmeting van de grootste tip - indien niet rond van vorm

.... L2 grootste afmeting van de grootste tip - indien niet rond van vorm

.. AT-TI ... totaal aantal tips van alle contacten in de kit

.. AT-PL ... totaal aantal plooiën van alle contacten in de kit

..... MERK ... merk van de contactor

..... TY-CR ... type van de contactor





For all our latest catalogue updates and company info: www.tvh.com



Fiche technique

KIT CONTACT DE CONTACTEUR

02-01-02-01

nom de votre société:



Type machine:
No série machine:

demande de prix
 commande

CODE: AT-CT x D x L1 x L2 x AT-TI x AT-PL x MERK x TY-CR

..

....

....

....

..

..

.....

.....

- AT-CT . . nombre de contacts
- D diamètre de la plus grande pastille
- L1 plus petite dimension de la plus grande pastille - si la forme n'est pas ronde
- L2 plus grande dimension de la plus grande pastille - si la forme n'est pas ronde
- AT-TI . . nombre total de pastilles de tous les contacts dans le kit
- AT-PL . . nombre total de plis de tous les contacts dans le kit
- MERK . . marque du contacteur
- TY-CR . . type contacteur





Technical detail

CONTACT KIT CONTACTOR

02-01-02-01



customer details:



Truck type:
Truck serial no.:

inquiry
 order

CODE: AT-CT x D x L1 x L2 x AT-TI x AT-PL x MERK x TY-CR

..

....

....

....

..

..

.....

.....

- AT-CT . . . number of contacts
- D diameter of the largest tip
- L1 minimum dimension of the largest tip - if shape is not round
- L2 maximum dimension of the largest tip - if shape is not round
- AT-TI . . . total number of tips of all contacts in the kit
- AT-PL . . . total number of curves of all contacts in the kit
- MERK . . . contactor brand
- TY-CR . . . contactor type





For all our latest catalogue updates and company info: www.tvh.com



Technische Daten

SATZ RELAI SKONTAKTE



02-01-02-01



Beispiel

Kundendaten:

Maschinentyp:
 Maschine Seriennr.:

Preisanfrage
 Bestellung

KODE: AT-CT x D x L1 x L2 x AT-TI x AT-PL x MERK x TY-CR

..

....

....

....

....

....

....

....

....

- AT-CT .. Anzahl Kontakte
- D Durchmesser der größten Spitze
- L1..... kleinste Abmessung der größten Spitze - wenn nicht rund
- L2..... größte Abmessung der größten Spitze - wenn nicht rund
- AT-TI... Spitzenzahl von allen Kontakten im Satz
- AT-PL .. Faltenzahl von allen Kontakten im Satz
- MERK .. Relaismarke
- TY-CR .. Relaistyp





TOTALSOURCE[®]

Look up
these parts via

PS ProductSearch

used for:
ALBRIGHT

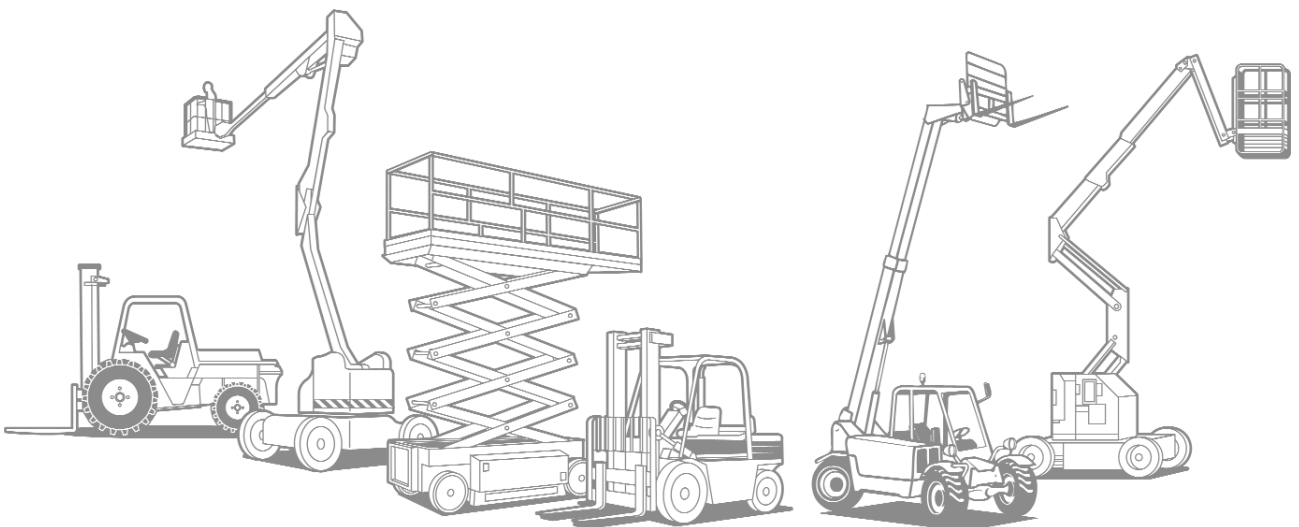



CONTACTS

For all our latest catalogue updates and company info: www.tvh.com

ALBRIGHT

ALBRIGHT

used for: **ALBRIGHT**

Type: DC182

Tip size: Ø 10,3 mm
Width: 15,8 mm
Length: 52 mm
Number of tips: 4

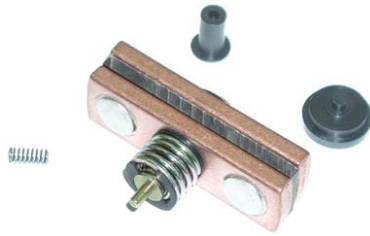

REF 132TA2029

Type: DC182

Tip size: Ø 10,3 mm
Width: 16,3 mm
Length: 108,7 mm
Number of tips: 2



REF 138TA6192

Type: DC182

Tip size: Ø 10,3 mm
Width: 16,5 mm
Length: 128 mm
Number of tips: 2



REF 138TA6209

Type: DC182

Tip size: Ø 10,3 mm
Width: 63 mm
Length: 92 mm
Number of tips: 6



REF 138TA6257

Type: DC182

Tip size: Ø 10,3 mm
Width: 63 mm
Length: 92 mm
Number of tips: 6



REF 138TA6259

Type: DC182

Tip size: Ø 10,3 mm
Width: 63 mm
Length: 92 mm
Number of tips: 6



REF 138TA6254

Type: DC182-L

Tip size: Ø 15,2 mm
Width: 63 mm
Length: 92 mm
Number of tips: 6



REF 138TA6256

Type: DC182B-BLOWOUTS

Tip size: Ø 10,3 mm
Width: 63 mm
Length: 92 mm
Number of tips: 6



REF 138TA6258

Type: DC182B-BLOWOUTS

Tip size: Ø 10,3 mm
Width: 63 mm
Length: 92 mm
Number of tips: 6



REF 138TA6255

Type: DC182B-BLOWOUTS

Tip size: Ø 10,3 mm
Width: 63 mm
Length: 92 mm
Number of tips: 6



REF 138TA6260

Type: DC182B-BLOWOUTS

Tip size: Ø 10,3 mm
Width: 63 mm
Length: 92 mm
Number of tips: 6



REF 138TA6263

Type: DC182B-BLOWOUTS

Tip size: Ø 10,3 mm
Width: 63 mm
Length: 92 mm
Number of tips: 6



REF 132TA2412

Type: DC182EE

Tip size: Ø 10,3 mm
Width: 16 mm
Length: 105,5 mm
Number of tips: 2



REF 138TA6237

Type: DC182EE

Tip size: Ø 10,3 mm
Width: 16 mm
Length: 129 mm
Number of tips: 2



REF 138TA6267

CONTACTS

For all our latest catalogue updates and company info: www.tvh.com



ALBRIGHT

used for: **ALBRIGHT**

Type: DC184B-BLOWOUTS

Tip size: Ø 10,3 mm
Width: 63 mm
Length: 92 mm
Number of tips: 4



REF 138TA6261



Type: DC184B-BLOWOUTS

Tip size: Ø 10,3 mm
Width: 63 mm
Length: 92 mm
Number of tips: 4



REF 138TA6262

Type: DC88

Tip size: Ø 8 mm
Width: 13 mm
Length: 89 mm
Number of tips: 2



REF 138TA6117

Type: DC88

Tip size: Ø 8 mm
Width: 52 mm
Length: 80 mm
Number of tips: 6



REF 138TA6264

Type: DC88B-BLOWOUTS

Tip size: Ø 8 mm
Width: 52 mm
Length: 80 mm
Number of tips: 6



REF 110TA9038

Type: DC88B-BLOWOUTS

Tip size: Ø 8 mm
Width: 52 mm
Length: 80 mm
Number of tips: 6



REF 138TA6266



Type: DC88B-BLOWOUTS

Tip size: Ø 8 mm
Width: 52 mm
Length: 80 mm
Number of tips: 6



REF 138TA6265



Type: SW100

Tip size: Ø 10,3 mm
Length: 34,7 mm
Number of tips: 1



REF 138TA6180

Type: SW100

Tip size: Ø 10,3 mm
Width: 12,7 mm
Length: 47 mm
Number of tips: 2



REF 138TA5975

Type: SW101

Tip size: Ø 10,3 mm
Width: 13 mm
Length: 59,3 mm
Number of tips: 1



REF 138TA5866

Type: SW101/102

Tip size: Ø 10,3 mm
Width: 12,5 mm
Length: 47,6 mm
Number of tips: 4



REF 138TA5868

Type: SW102

Tip size: Ø 10,3 mm
Width: 13 mm
Length: 105 mm
Number of tips: 2



REF 138TA5864

Type: SW106/125

Tip size: Ø 15,2 mm
Width: 16 mm
Length: 45,6 mm
Number of tips: 2



REF 138TA6226

Type: SW120

Tip size: Ø 10,3 mm
Width: 10,2 mm
Length: 39 mm
Number of tips: 4



REF 138TA6277



CONTACTS

For all our latest catalogue updates and company info: www.tvh.com

used for: **ALBRIGHT**

Type: SW125/155

Tip size: Ø 15,2 mm
Length: 39 mm
Number of tips: 1



REF 108TA5197

Type: SW128

Tip size: Ø 8 mm
Width: 29 mm
Length: 36,5 mm
Number of tips: 2



REF 138TA5974

Type: SW159

Tip size: Ø 10,3 mm
Length: 44,5 mm
Number of tips: 2



REF 138TA6352

Type: SW180

Tip size: Ø 10,3 mm
Length: 34,4 mm
Number of tips: 1



REF 138TA6208

Type: SW180

Tip size: Ø 10,3 mm
Width: 15,9 mm
Length: 52 mm
Number of tips: 2



REF 138TA6187

Type: SW180L-LARGE CONTACT

Tip size: Ø 15,2 mm
Length: 34,3 mm
Number of tips: 1



REF 138TA5889

Type: SW180L-LARGE CONTACTS

Tip size: Ø 15,2 mm
Width: 16 mm
Length: 52 mm
Number of tips: 2



REF 138TA6173

Type: SW180T

Tip size: Ø 10,3 mm
Width: 16 mm
Length: 48,7 mm
Number of tips: 2



REF 138TA6334

Type: SW181/182

Tip size: Ø 10,3 mm
Width: 15,8 mm
Length: 52 mm
Number of tips: 4



REF 138TA6175

Type: SW181L-LARGE CONTACTS

Tip size: Ø 15,2 mm
Width: 15,8 mm
Length: 52,2 mm
Number of tips: 4



REF 138TA5876

Type: SW181T

Tip size: Ø 10,3 mm
Width: 16 mm
Length: 52,5 mm
Number of tips: 4



REF 138TA6310

Type: SW181T

Tip size: Ø 10,3 mm
Width: 16 mm
Length: 62 mm
Number of tips: 1



REF 115TA5485

Type: SW181T-NISSAN

Tip size: Ø 10,3 mm
Width: 15,8 mm
Length: 52 mm
Number of tips: 4



REF 138TA6268

Type: SW182

Tip size: Ø 10,3 mm
Width: 16 mm
Length: 108,3 mm
Number of tips: 3



REF 138TA5807

CONTACTS

For all our latest catalogue updates and company info: www.tvh.com



ALBRIGHT

used for: **ALBRIGHT**

Type: SW185

Tip size: Ø 10,3 mm
Width: 16 mm
Length: 52,4 mm
Number of tips: 2



REF 138TA6272

Type: SW190

Tip size: Ø 10,3 mm
Width: 16 mm
Length: 45,8 mm
Number of tips: 4



REF 138TA6235

Type: SW190L-LARGE CONTACTS

Tip size: Ø 15,2 mm
Width: 16 mm
Length: 45,8 mm
Number of tips: 4



REF 138TA5883

Type: SW200 SERIES

Tip size: Ø 18 mm
Length: 52 mm
Number of tips: 1



REF 138TA6042

Type: SW200-JUNGH(M8)

Tip size: Ø 18 mm
Length: 47 mm
Number of tips: 1



REF 109TA7989

Type: SW201

Tip size: Ø 15,2 mm
Width: 19 mm
Length: 57,5 mm
Number of tips: 2



REF 138TA5882

Type: SW201 - JUNGH(M8)

Tip size: Ø 15,2 mm
Width: 19,3 mm
Length: 73,2 mm
Number of tips: 1



REF 109TA8677

Type: SW201-TCM

Tip size: Ø 18 mm
Length: 57,5 mm
Number of tips: 4



REF 122TA7615

Type: SW201/202

Tip size: Ø 15,2 mm
Width: 19 mm
Length: 74 mm
Number of tips: 1



REF 132TA2461

Type: SW201/202

Tip size: Ø 15,2 mm
Width: 19,5 mm
Length: 73,5 mm
Number of tips: 1



REF 138TA6317

Type: SW201/202

Tip size: Ø 18 mm
Width: 19 mm
Length: 58 mm
Number of tips: 4



REF 138TA6183

Type: SW201/202

Tip size: Ø 18 mm
Width: 19 mm
Length: 74 mm
Number of tips: 1



REF 138TA6039

Type: SW201T

Tip size: Ø 15,2 mm
Width: 19,1 mm
Length: 74,1 mm
Number of tips: 1



REF 122TA7614

Type: SW202

Tip size: Ø 15,2 mm
Width: 19 mm
Length: 131 mm
Number of tips: 2



REF 123TA8984



CONTACTS

For all our latest catalogue updates and company info: www.tvh.com

used for: **ALBRIGHT**

Type: SW202

Tip size: Ø 15,2 mm
Width: 19 mm
Length: 132 mm
Number of tips: 2

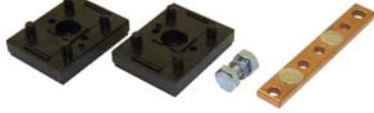

REF 138TA6044

Type: SW202

Tip size: Ø 15,2 mm
Width: 19,2 mm
Length: 131,5 mm
Number of tips: 2



REF 132TA2460

Type: SW202-JUNGH(M8)

Tip size: Ø 15,2 mm
Width: 19,2 mm
Length: 132 mm
Number of tips: 2



REF 110TA2736

Type: SW210

Tip size: Ø 18 mm
Width: 19 mm
Length: 57,7 mm
Number of tips: 2



REF 138TA6184

Type: SW215

Tip size: Ø 18 mm
Width: 19 mm
Length: 57,6 mm
Number of tips: 4



REF 138TA6170

Type: SW280

Tip size: Ø 15,2 mm
Length: 52 mm
Number of tips: 1



REF 138TA6269

Type: SW280

Tip size: Ø 15,2 mm
Width: 19 mm
Length: 57,5 mm
Number of tips: 2



REF 138TA6270

Type: SW62

Tip size: Ø 10,4 mm
Length: 34,7 mm
Number of tips: 1



REF 138TA5808

Type: SW62

Tip size: Ø 10,4 mm
Width: 43 mm
Length: 44,5 mm
Number of tips: 2



REF 138TA6179

Type: SW65

Tip size: Ø 10,4 mm
Width: 36,6 mm
Length: 44,5 mm
Number of tips: 2



REF 138TA5968

Type: SW74

Tip size: Ø 10,3 mm
Width: 10,3 mm
Length: 38,7 mm
Number of tips: 2



REF 138TA5836

Type: SW80L-LARGE CONTACT

Tip size: Ø 10,3 mm
Length: 31 mm
Number of tips: 1



REF 138TA6153

Type: SW80L-LARGE CONTACTS

Tip size: Ø 10,3 mm
Width: 11,6 mm
Length: 42 mm
Number of tips: 2



REF 138TA6284

Type: SW80SERIES

Tip size: Ø 8 mm
Length: 30,8 mm
Number of tips: 1



REF 138TA5817

CONTACTS

For all our latest catalogue updates and company info: www.tvh.com



ALBRIGHT

used for: **ALBRIGHT**

Type: SW82/822

Tip size: Ø 8 mm
Width: 12,7 mm
Length: 34 mm
Number of tips: 2



REF 138TA6210

Type: SW82/822L-LARGE CONTACTS

Tip size: Ø 10,3 mm
Width: 12,7 mm
Length: 33,8 mm
Number of tips: 2



REF 138TA6206

Type: SW84/88

Tip size: Ø 8 mm
Width: 12,8 mm
Length: 57,4 mm
Number of tips: 1



REF 138TA5865

Type: SW84/88/DC88

Tip size: Ø 8 mm
Width: 11,4 mm
Length: 41,6 mm
Number of tips: 4



REF 138TA5914

Type: SW84L/88L/DC88L-LARGE CONTA

Tip size: Ø 10,3 mm
Width: 11,5 mm
Length: 42 mm
Number of tips: 4



REF 138TA5885

Type: SW87/107/108

Tip size: Ø 10,3 mm
Length: 10,7 mm
Number of tips: 1



REF 138TA5854

Type: SW87/107/108

Tip size: Ø 10,3 mm
Width: 34,8 mm
Length: 44,4 mm
Number of tips: 2

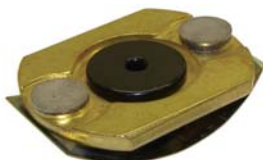

REF 138TA6364

Type: SW87/107/108

Tip size: Ø 10,3 mm
Width: 35 mm
Length: 44,8 mm
Number of tips: 2



REF 122TA7638

Type: SW88

Tip size: Ø 8,5 mm
Width: 12,7 mm
Length: 98 mm
Number of tips: 2



REF 138TA5898

Type: SW89

Tip size: Ø 10,3 mm
Length: 51,5 mm
Number of tips: 1



REF 138TA6231

Type: SW89

Tip size: Ø 10,3 mm
Width: 48,2 mm
Length: 57,2 mm
Number of tips: 2



REF 138TA6219

Type: SW89

Tip size: Ø 15,5 mm
Width: 48 mm
Length: 57,2 mm
Number of tips: 2



REF 138TA5967

Look up
these parts via

PS ProductSearch

CONTACT KITS

For all our latest catalogue updates and company info: www.tvh.com

used for: **ALBRIGHT**

Type: DC182
Tip size: \varnothing 10,3 mm

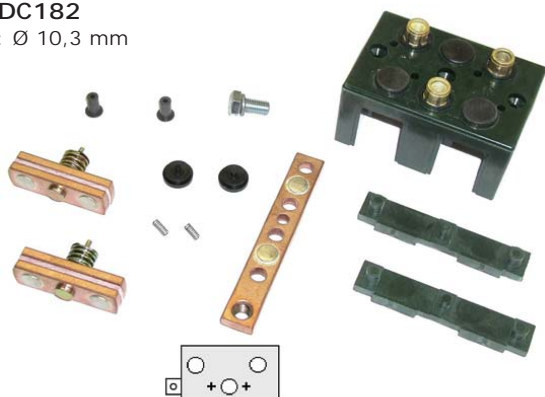

REF 133TA3479

Type: DC182
Tip size: \varnothing 10,3 mm

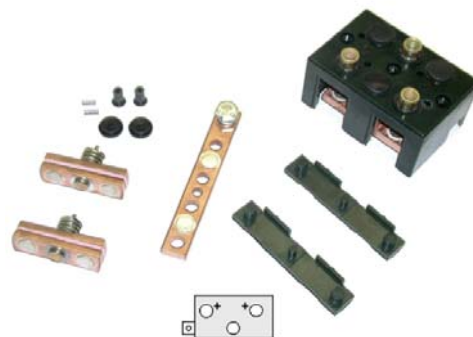

REF 132TA3188

Type: DC182 - MALE
Tip size: \varnothing 10,3 mm

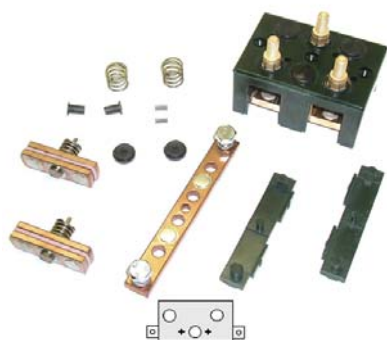

REF 133TA3480

Type: DC182- SPECIAL DAEWOO
Tip size: \varnothing 10,3 mm

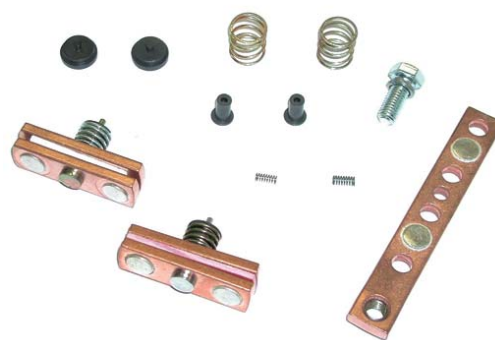

REF 133TA6076

Type: DC182-L - LARGE CONTACTS
Tip size: \varnothing 15,2 mm

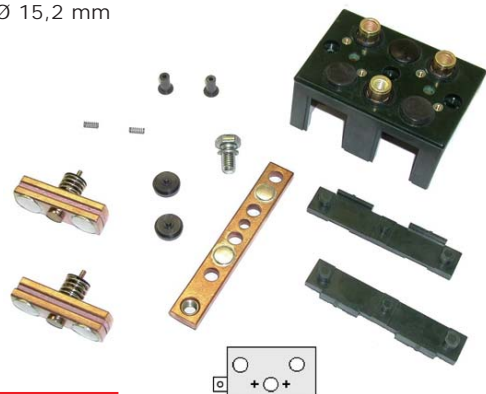

REF 133TA6143

Type: DC182-MALE-SPECIAL JUNGH
Tip size: \varnothing 10,3 mm

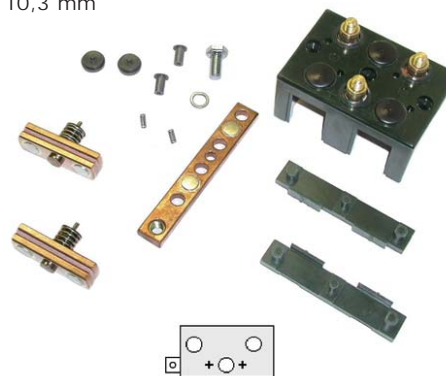

REF 138TA6520

Type: DC182-SPECIAL CROWN
Tip size: \varnothing 10,3 mm

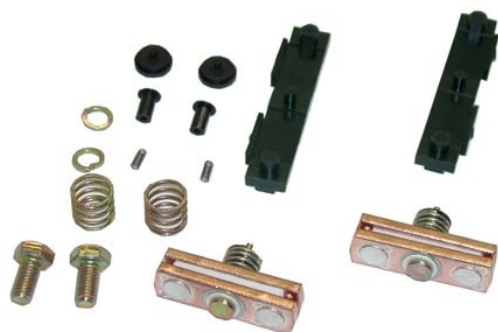

REF 133TA7540

Type: DC182-TEXTURED TIPS
Tip size: \varnothing 10,3 mm

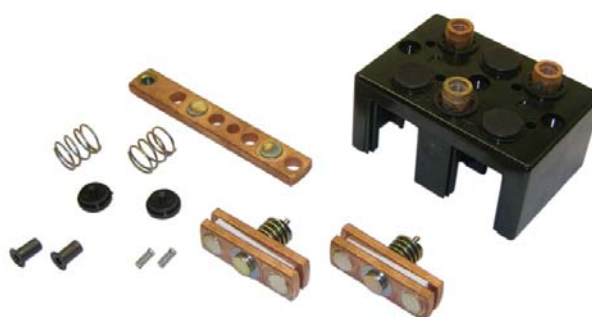

REF 133TA7775

CONTACT KITS

For all our latest catalogue updates and company info: www.tvh.com



ALBRIGHT

used for: **ALBRIGHT**

Type: DC182B
Tip size: Ø 10,3 mm

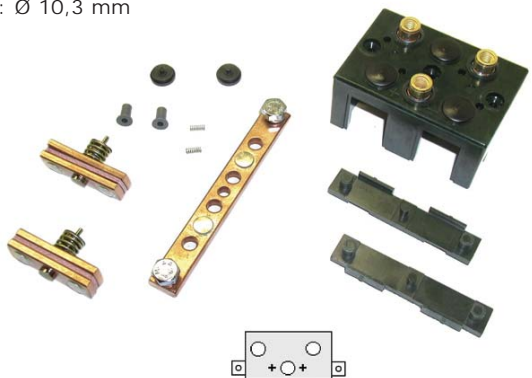

REF 138TA6508

Type: DC182B
Tip size: Ø 10,3 mm

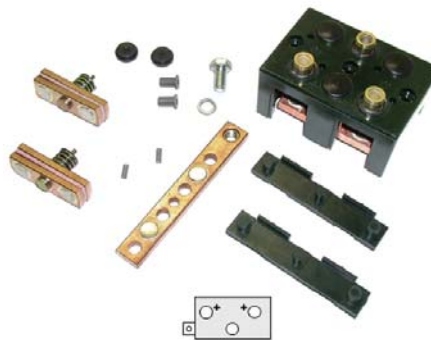

REF 133TA5368

Type: DC182B
Tip size: Ø 10,3 mm

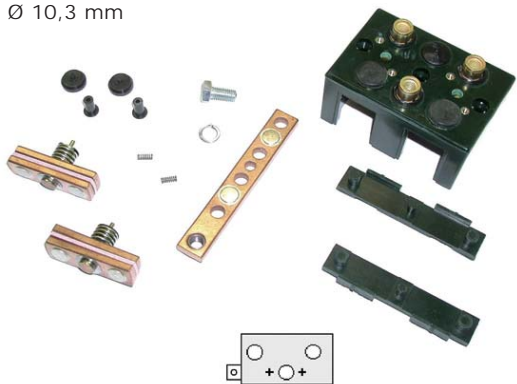

REF 133TA5284

Type: DC182B
Tip size: Ø 10,3 mm

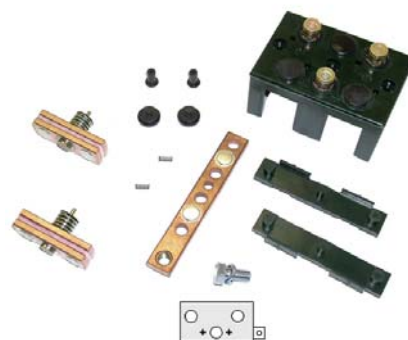

REF 133TA5936

Type: DC182B - CLOSED COVER
Tip size: Ø 10,3 mm

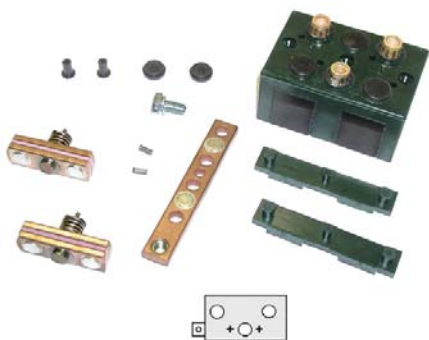

REF 133TA6917

Type: DC182B - MALE
Tip size: Ø 10,3 mm

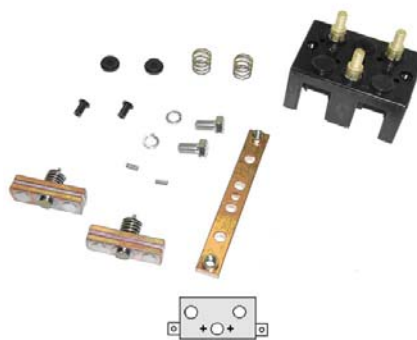

REF 133TA7299

Type: DC182B - TEXTURED TIPS
Tip size: Ø 10,3 mm

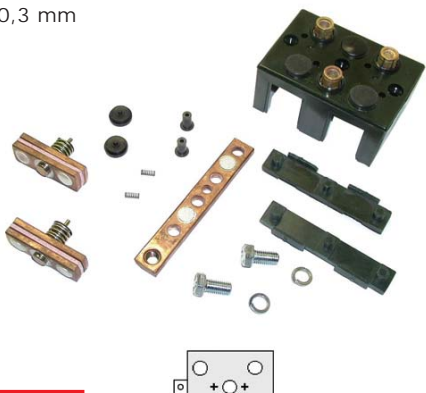

REF 133TA5940

Type: DC182B-L -LARGE CONTACTS
Tip size: Ø 15,2 mm

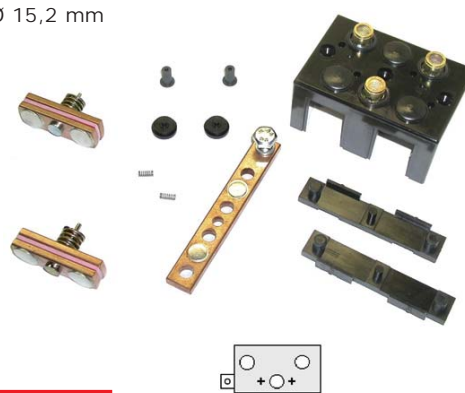

REF 133TA6447

CONTACT KITS

For all our latest catalogue updates and company info: www.tvh.com

used for: **ALBRIGHT**

Type: DC182B-TEXTURED TIPS
Tip size: Ø 10,3 mm

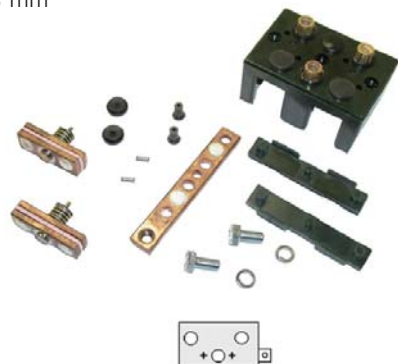

REF 122TA7494

Type: DC184-LARGE CONTACTS
Tip size: Ø 15,2 mm



REF 116TA5557

Type: DC184B
Tip size: Ø 10,3 mm



REF 107TA1451

Type: DC88
Tip size: Ø 8 mm

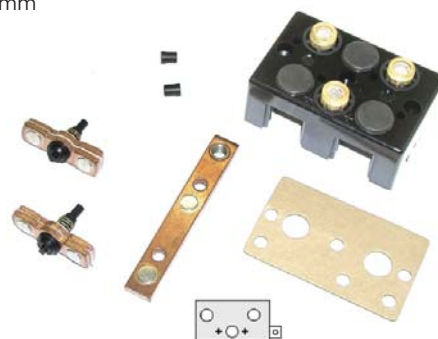

REF 133TA5749

Type: DC88
Tip size: Ø 8 mm

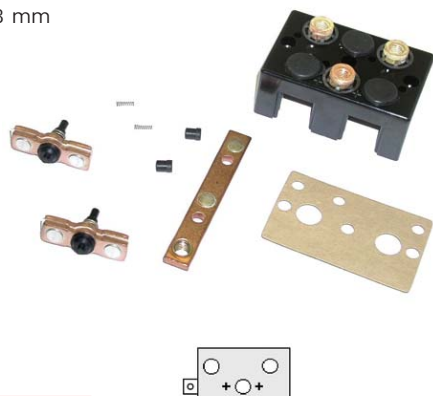

REF 133TA7080

Type: DC88-L -LARGE CONTACTS
Tip size: Ø 10,3 mm

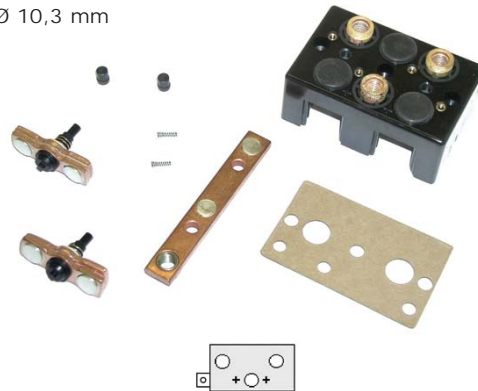

REF 133TA6031

Type: DC88B
Tip size: Ø 8 mm

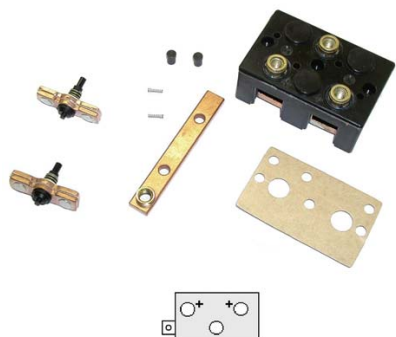

REF 133TA5814

Type: DC88B
Tip size: Ø 8 mm

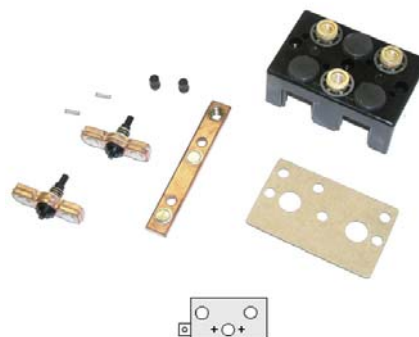

REF 133TA4429

CONTACT KITS

For all our latest catalogue updates and company info: www.tvh.com



ALBRIGHT

used for: **ALBRIGHT**

Type: DC88B
Tip size: \varnothing 8 mm

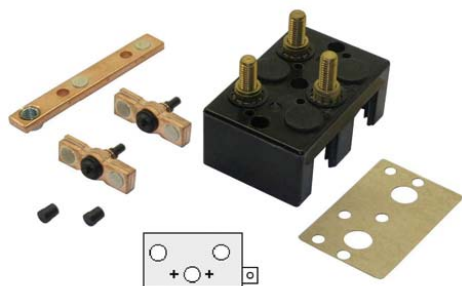

REF 133TA7721

Type: DC88B - TEXTURED TIPS
Tip size: \varnothing 8 mm

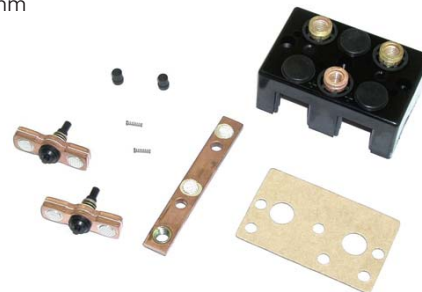

REF 138TA6514

Type: DC88B- L - LARGE CONTACTS
Tip size: \varnothing 10,3 mm

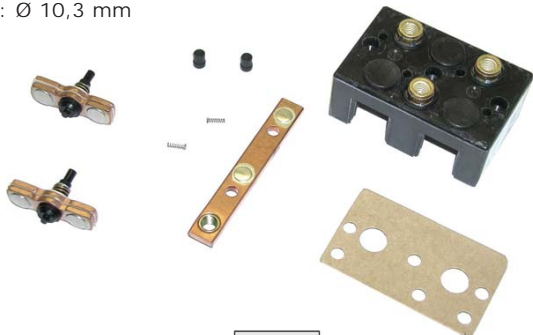

REF 110TA3624

Type: DC88B-L-SPECIAL DAEWOO
Tip size: \varnothing 10,3 mm



REF 122TA7668

Type: ED125/SD150
Tip size: \varnothing 8 mm

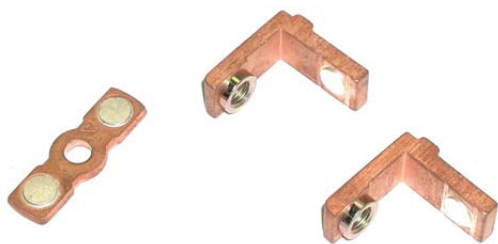

REF 133TA6201

Type: ED250
Tip size: \varnothing 10,3 mm



REF 138TA6512

Type: SW100
Tip size: \varnothing 10,3 mm



REF 133TA4301

Type: SW100
Tip size: \varnothing 10,3 mm



REF 133TA5489

CONTACT KITS

For all our latest catalogue updates and company info: www.tvh.com

used for: **ALBRIGHT**

Type: SW101
Tip size: \varnothing 10,3 mm

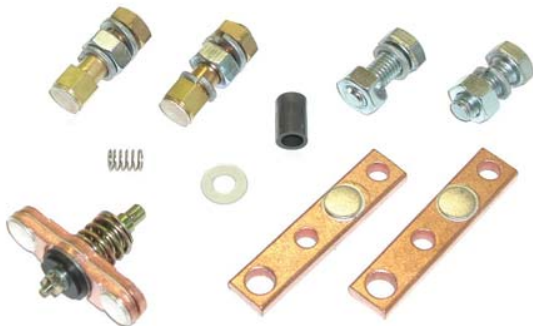

REF 133TA5662

Type: SW102
Tip size: \varnothing 10,3 mm

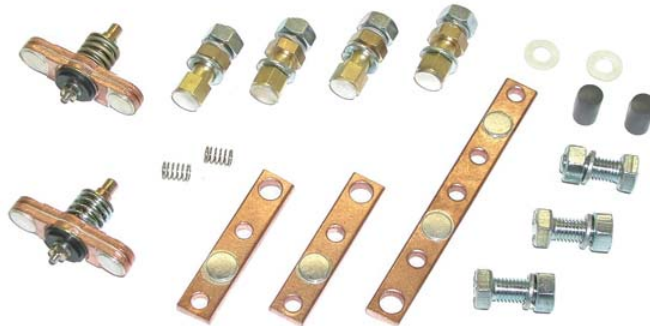

REF 133TA6501

Type: SW102- HYSTER
Tip size: \varnothing 10,3 mm



REF 108TA7891

Type: SW112
Tip size: \varnothing 10,3 mm



REF 133TA4094

Type: SW120
Tip size: \varnothing 10,3 mm



REF 132TA3267

Type: SW120
Tip size: \varnothing 10,3 mm



REF 133TA6134

Type: SW128
Tip size: \varnothing 8 mm



REF 133TA3539

Type: SW160
Tip size: \varnothing 10,3 mm



REF 110TA3560

CONTACT KITS

For all our latest catalogue updates and company info: www.tvh.com



ALBRIGHT

used for: **ALBRIGHT**

Type: SW160
Tip size: \varnothing 10,3 mm



REF 108TA8023

Type: SW180
Tip size: \varnothing 10,3 mm



REF 133TA7094

Type: SW180
Tip size: \varnothing 10,3 mm

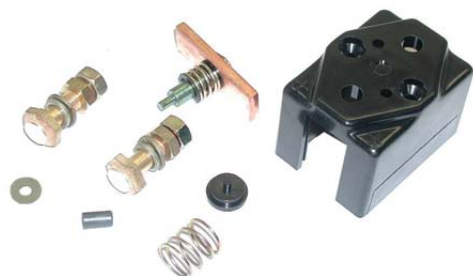

REF 133TA7446

Type: SW180L-LARGE CONTACTS
Tip size: \varnothing 15,2 mm



REF 133TA7630

Type: SW181
Tip size: \varnothing 10,3 mm

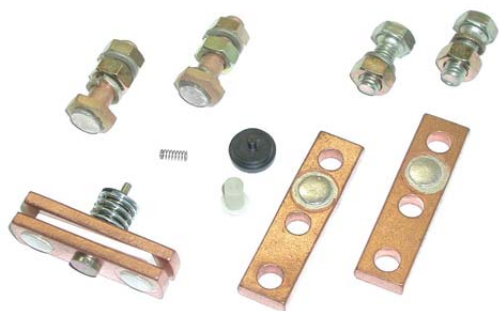

REF 133TA5958

Type: SW181B - CLARK
Tip size: \varnothing 10,3 mm

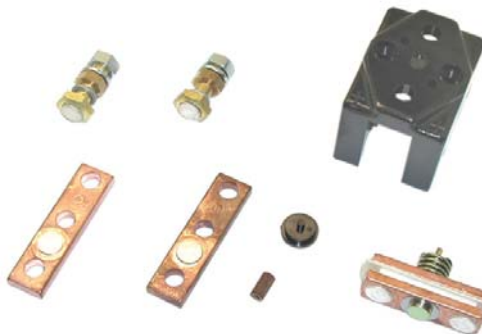

REF 133TA5953

Type: SW181L - LARGE CONTACTS
Tip size: \varnothing 15,2 mm

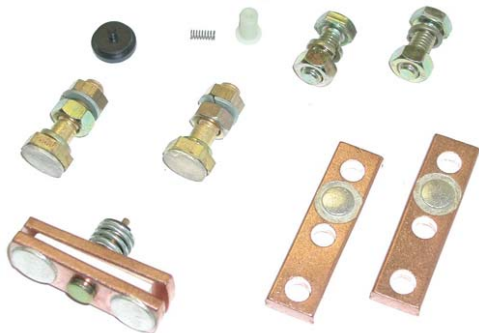

REF 133TA6112

Type: SW181T - TEXTURED TIPS
Tip size: \varnothing 10,3 mm

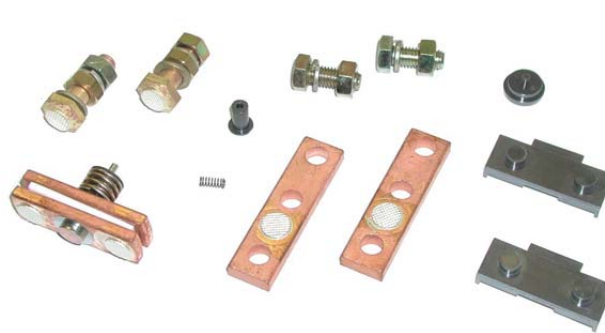

REF 133TA6193

CONTACT KITS

For all our latest catalogue updates and company info: www.tvh.com

used for: **ALBRIGHT**

Type: SW182
Tip size: \varnothing 10,3 mm

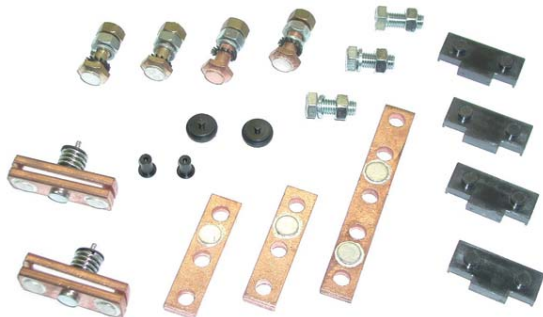

REF 133TA4647

Type: SW182 + SPRINGS
Tip size: \varnothing 10,3 mm

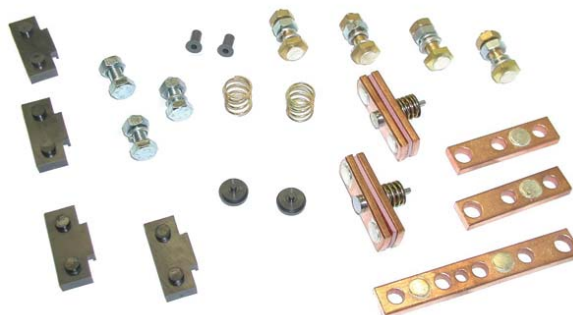

REF 133TA3470

Type: SW182B + COVERS/SPRINGS
Tip size: \varnothing 10,3 mm

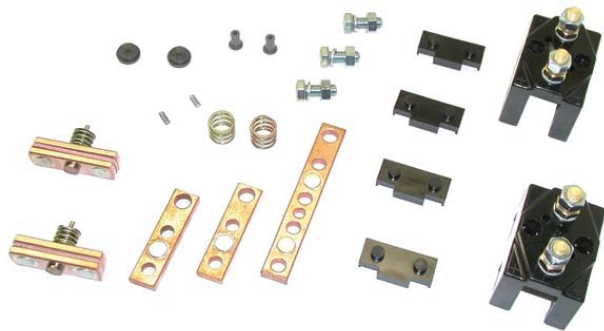

REF 133TA5271

Type: SW182L - LARGE CONTACTS
Tip size: \varnothing 15,2 mm

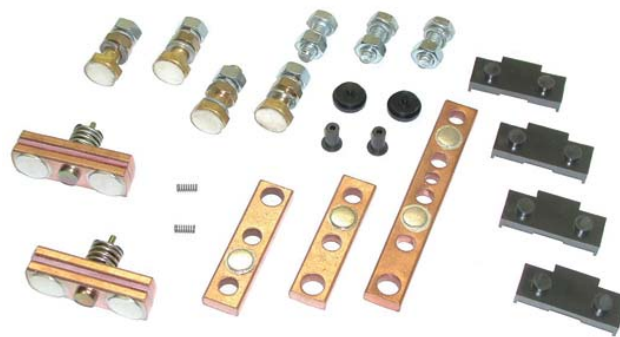

REF 133TA6353

Type: SW185
Tip size: \varnothing 10,3 mm



REF 133TA5583

Type: SW190
Tip size: \varnothing 10,3 mm



REF 133TA5906

Type: SW190L - LARGE CONTACTS
Tip size: \varnothing 15,2 mm



REF 133TA6539

Type: SW192
Tip size: \varnothing 10,3 mm



REF 133TA5830

CONTACT KITS

For all our latest catalogue updates and company info: www.tvh.com



ALBRIGHT

used for: **ALBRIGHT**

Type: SW192L - LARGE CONTACTS

Tip size: \varnothing 15,2 mm



REF 133TA3394

Type: SW200

Tip size: \varnothing 18 mm



REF 133TA6250

Type: SW200

Tip size: \varnothing 18 mm



REF 138TA6518

Type: SW200 - LINDE

Tip size: \varnothing 18 mm



REF 133TA5066

Type: SW200-JUNGH(M8)

Tip size: \varnothing 18 mm



REF 138TA6506

Type: SW200A - AUX.

Tip size: \varnothing 18 mm



REF 133TA5659

Type: SW200N - NO BLOWOUTS

Tip size: \varnothing 18 mm



REF 133TA5435

Type: SW200T-TEXTURED TIPS

Tip size: \varnothing 15,2 mm



REF 115TA5500

CONTACT KITS

For all our latest catalogue updates and company info: www.tvh.com

used for: **ALBRIGHT**

Type: SW201
Tip size: Ø 18 mm



REF 133TA5187

Type: SW201
Tip size: Ø 18 mm

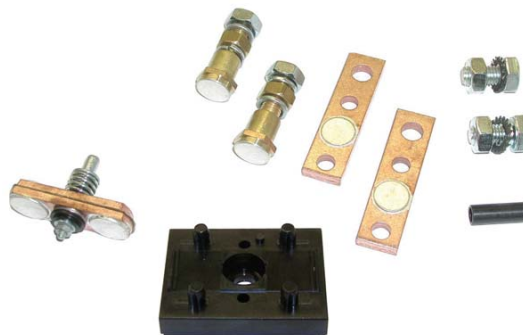

REF 133TA6221

Type: SW201 - JUNGH(M8)
Tip size: Ø 18 mm

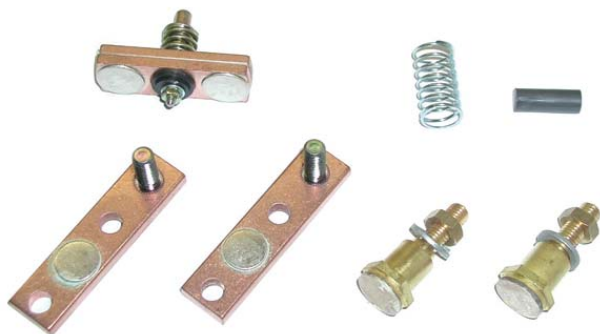

REF 138TA6498

Type: SW201T-TEXTURED TIPS
Tip size: Ø 18 mm



REF 133TA7504

Type: SW202
Tip size: Ø 18 mm



REF 133TA7040

Type: SW202- JUNGH(M8)
Tip size: Ø 18 mm

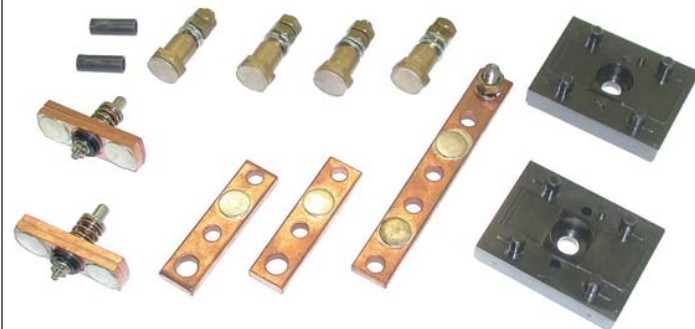

REF 138TA6509

Type: SW202T - TEXTURED TIPS
Tip size: Ø 15,2 mm



REF 133TA7452

Type: SW210
Tip size: Ø 18 mm



REF 133TA4344

CONTACT KITS

For all our latest catalogue updates and company info: www.tvh.com



ALBRIGHT

used for: **ALBRIGHT**

Type: SW215
Tip size: Ø 18 mm



REF 133TA6340

Type: SW280 - LINDE
Tip size: Ø 15,2 mm



REF 132TA3322

Type: SW62
Tip size: Ø 10,3 mm



REF 138TA6513

Type: SW62
Tip size: Ø 10,3 mm



REF 133TA4402

Type: SW62
Tip size: Ø 10,3 mm



REF 133TA5613

Type: SW65
Tip size: Ø 10,3 mm



REF 133TA6614

Type: SW80
Tip size: Ø 8 mm



REF 138TA6515

Type: SW80
Tip size: Ø 8 mm

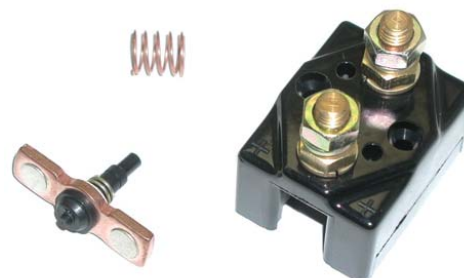

REF 133TA4849

CONTACT KITS

For all our latest catalogue updates and company info: www.tvh.com

used for: **ALBRIGHT**

Type: SW80L - LARGE CONTACTS

Tip size: \varnothing 10,3 mm



REF 133TA3628

Type: SW80L - LARGE CONTACTS

Tip size: \varnothing 10,3 mm



REF 133TA4630

Type: SW80L - LARGE CONTACTS

Tip size: \varnothing 10,3 mm



REF 133TA6208

Type: SW82

Tip size: \varnothing 8 mm



REF 138TA6505

Type: SW822

Tip size: \varnothing 8 mm



REF 133TA4172

Type: SW822L - LARGE CONTACTS

Tip size: \varnothing 10,3 mm



REF 133TA6608

Type: SW82L

Tip size: \varnothing 10,3 mm



REF 133TA7722

Type: SW82L - LARGE CONTACTS

Tip size: \varnothing 10,3 mm



REF 133TA4769

CONTACT KITS

For all our latest catalogue updates and company info: www.tvh.com



ALBRIGHT

used for: **ALBRIGHT**

Type: **SW82L - LARGE CONTACTS**

Tip size: \varnothing 10,3 mm



REF 133TA6256

Type: **SW84**

Tip size: \varnothing 8 mm



REF 133TA6925

Type: **SW84L - LARGE CONTACTS**

Tip size: \varnothing 10,3 mm



REF 133TA5239

Type: **SW88**

Tip size: \varnothing 8 mm

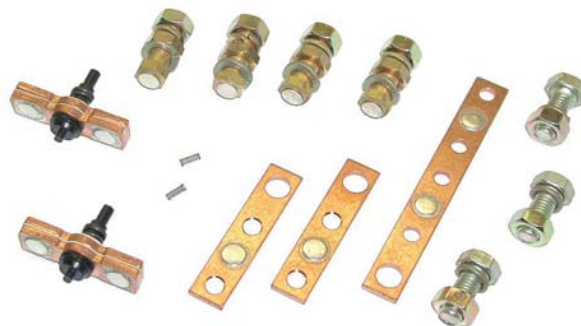

REF 133TA4703

Type: **SW88L - LARGE CONTACTS**

Tip size: \varnothing 10,3 mm

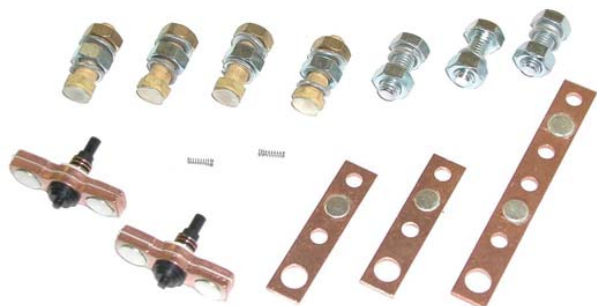

REF 133TA5483

Type: **SW88T-TEXTURED TIPS**

Tip size: \varnothing 8 mm

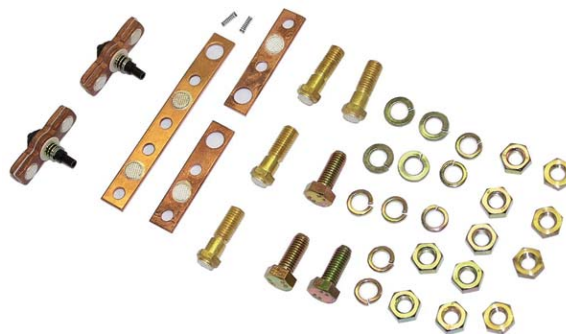

REF 133TA7569

Type: **SW89**

Tip size: \varnothing 15,2 mm



REF 133TA3586

Type: **SW92L - LARGE CONTACTS**

Tip size: \varnothing 10,3 mm



REF 107TA1439



TOTALSOURCE[®]

Look up
these parts via

PS ProductSearch

used for:
CABLEFORM

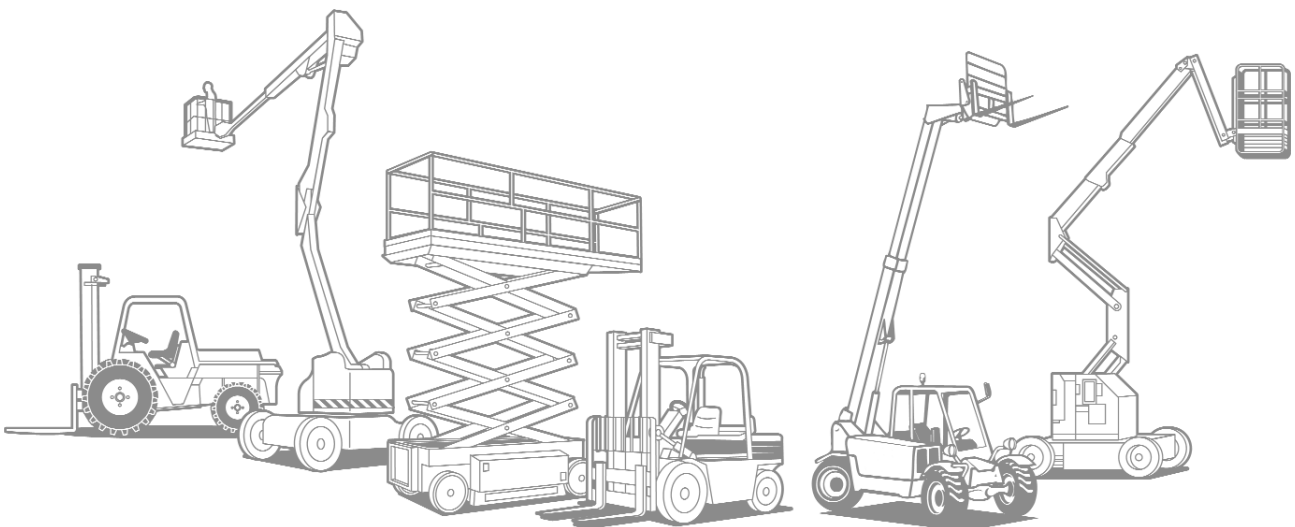



CONTACTS

For all our latest catalogue updates and company info: www.tvh.com

used for: **CABLEFORM**

Type:

Width: 22,2 mm
Length: 55 mm
Number of tips: 0



REF 132TA2513

Type: 100

Tip size: Ø 16 mm
Width: 16 mm
Length: 16 mm
Number of tips: 1



REF 138TA6004

Type: 100

Tip size: Ø 16 mm
Width: 16 mm
Length: 57 mm
Number of tips: 1



REF 138TA6024

Type: 100

Tip size: Ø 16 mm
Width: 21 mm
Length: 61 mm
Number of tips: 2



REF 138TA6149

Type: 100-CO

Tip size: Ø 16 mm
Width: 16 mm
Length: 56 mm
Number of tips: 1



REF 138TA6021

Type: 100-SP

Width: 16 mm
Length: 56 mm
Number of tips: 0



REF 138TA6040

Type: 1000

Tip size: Ø 16 mm
Width: 16 mm
Length: 40,5 mm
Number of tips: 1



REF 138TA6337

Type: 1000-CO

Tip size: Ø 16 mm
Width: 16 mm
Length: 71 mm
Number of tips: 2



REF 138TA5850

Type: 1000-CO

Tip size: Ø 16 mm
Width: 18 mm
Length: 71,4 mm
Number of tips: 2



REF 138TA5830

Type: 1000-DPCO

Tip size: 3,4 X 18,3 mm
Width: 13,8 mm
Length: 82,4 mm
Number of tips: 2

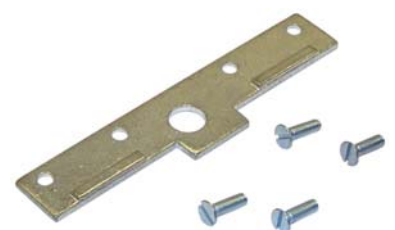

REF 138TA5813

Type: 1000-SPNO

Tip size: Ø 16 mm
Width: 18 mm
Length: 71 mm
Number of tips: 1



REF 138TA5810

Type: 1000-SPNO

Tip size: Ø 16 mm
Width: 18 mm
Length: 71 mm
Number of tips: 1



REF 138TA5857

Type: 1100

Tip size: Ø 15 mm
Width: 16,3 mm
Length: 105,6 mm
Number of tips: 2



REF 132TA2487

Type: 1100

Tip size: Ø 16 mm
Width: 16 mm
Length: 100,7 mm
Number of tips: 2



REF 138TA6232

CABLEFORM

CABLEFORM

CONTACTS

For all our latest catalogue updates and company info: www.tvh.com



used for: **CABLEFORM**

CABLEFORM

CABLEFORM

Type: 1100

Tip size: Ø 16 mm
Width: 16 mm
Length: 103 mm
Number of tips: 2



REF 132TA2425

Type: 1100

Tip size: Ø 16 mm
Width: 18 mm
Length: 49 mm
Number of tips: 1



REF 138TA5997

Type: 1100-SPCO

Tip size: Ø 16 mm
Width: 16 mm
Length: 56 mm
Number of tips: 2



REF 109TA8944

Type: 1100-SPCO

Tip size: Ø 16 mm
Width: 16 mm
Length: 60 mm
Number of tips: 2



REF 138TA5841

Type: 1100-SPCO-LH

Tip size: Ø 16 mm
Width: 16 mm
Length: 57,4 mm
Number of tips: 1



REF 108TA6378

Type: 1100-SPCO-RH

Tip size: Ø 16 mm
Width: 16 mm
Length: 57,7 mm
Number of tips: 1



REF 108TA6371

Type: 1100-SPNO

Tip size: Ø 16 mm
Width: 16 mm
Length: 56 mm
Number of tips: 1



REF 138TA6028

Type: 1127

Tip size: Ø 16 mm
Width: 16 mm
Length: 122,5 mm
Number of tips: 2



REF 138TA6188

Type: 1200-CO

Tip size: Ø 20 mm
Width: 22,2 mm
Length: 136 mm
Number of tips: 2



REF 134TA2266

Type: 1200-NO

Tip size: Ø 19 mm
Width: 22,4 mm
Length: 135,5 mm
Number of tips: 1



REF 138TA6201

Type: 1300

Tip size: 8 X 12 mm
Width: 12 mm
Length: 40 mm
Number of tips: 1



REF 138TA6025

Type: 1300-SPCO

Tip size: 8 X 12 mm
Width: 12 mm
Length: 44 mm
Number of tips: 1



REF 109TA9589

Type: 1300-SPCO

Tip size: 8 X 12 mm
Width: 12 mm
Length: 62 mm
Number of tips: 2



REF 138TA6026

Type: 1300-SPNO

Tip size: 8 X 12 mm
Width: 12 mm
Length: 62 mm
Number of tips: 1



REF 138TA6027



CONTACTS

For all our latest catalogue updates and company info: www.tvh.com

used for: **CABLEFORM**

CABLEFORM

CABLEFORM

Type: 1400

Tip size: 15 X 18 mm
Width: 18,2 mm
Length: 59 mm
Number of tips: 1



REF 110TA2091

Type: 1400

Tip size: Ø 16 mm
Width: 18 mm
Length: 45,5 mm
Number of tips: 1



REF 138TA6167

Type: 1400-SPCO

Tip size: 15 X 18 mm
Width: 18,5 mm
Length: 87,6 mm
Number of tips: 2



REF 138TA5847

Type: 1400-SPNO

Tip size: 15 X 18 mm
Width: 18 mm
Length: 88 mm
Number of tips: 1



REF 138TA5820

Type: 200

Width: 16,3 mm
Length: 19,5 mm
Number of tips: 0



REF 138TA6354

Type: 200

Tip size: 16 X 19 mm
Width: 17 mm
Length: 79 mm
Number of tips: 1



REF 138TA6168

Type: 200

Tip size: Ø 22,2 mm
Width: 22,2 mm
Length: 56,5 mm
Number of tips: 1



REF 108TA5457

Type: 200

Tip size: Ø 22,5 mm
Width: 22,4 mm
Length: 25,5 mm
Number of tips: 1



REF 138TA5851

Type: 200-DP

Tip size: Ø 22 mm
Width: 22,3 mm
Length: 98,3 mm
Number of tips: 2



REF 138TA5844

Type: 200-DP

Tip size: Ø 22 mm
Width: 22,3 mm
Length: 98,5 mm
Number of tips: 2



REF 108TA7307

Type: 200-SPCO

Tip size: Ø 22,2 mm
Width: 22 mm
Length: 81 mm
Number of tips: 2



REF 138TA5831

Type: 200-SPNO

Tip size: Ø 22,2 mm
Width: 22,5 mm
Length: 81,3 mm
Number of tips: 1



REF 138TA5845

Type: 200/300

Tip size: Ø 22,2 mm
Width: 22,2 mm
Length: 73 mm
Number of tips: 1



REF 108TA5335

Type: 300-CO

Tip size: Ø 22,2 mm
Width: 22,3 mm
Length: 136,8 mm
Number of tips: 2



REF 138TA5823



used for: CABLEFORM

Type: 300-DP

Tip size: Ø 22,2 mm
Width: 22,3 mm
Length: 127,4 mm
Number of tips: 2



REF 138TA5848

Type: 300-NO

Tip size: Ø 22,2 mm
Width: 22,2 mm
Length: 137 mm
Number of tips: 1



REF 138TA5849

CABLEFORM

CABLEFORM



CONTACT KITS

For all our latest catalogue updates and company info: www.tvh.com

used for: **CABLEFORM**

Type: a. 100-NO
Tip size: Ø 16 mm

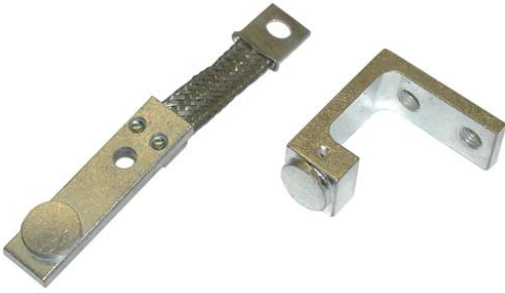

REF 133TA3792

Type: b. 100-DPCO
Tip size: Ø 16 mm



REF 133TA5380

Type: c. 1000-NO-SPECIAL CLARK
Tip size: Ø 16 mm



REF 108TA8036

Type: d. 1000-NO
Tip size: Ø 16 mm



REF 133TA4765

Type: e. 1000-CO CHANGEOVER
Tip size: Ø 16 mm



REF 133TA3400

Type: f. 1000-DPCO
Tip size: Ø 16 mm

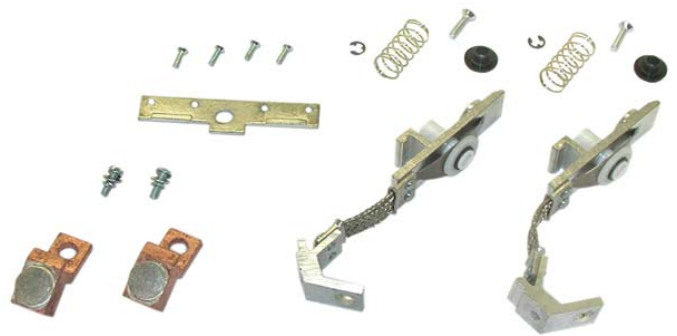

REF 103TA1570

Type: g. 1100-SPNO
Tip size: Ø 16 mm

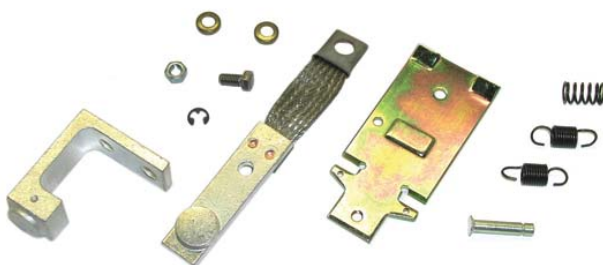

REF 133TA5259

Type: h. 1100-SPCO
Tip size: Ø 16 mm

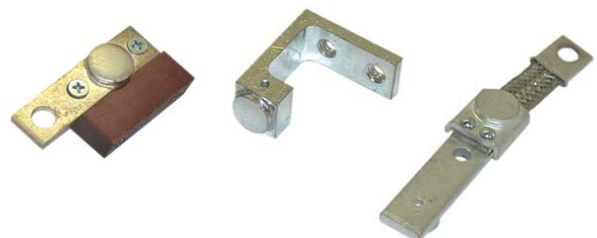

REF 103TA1604



used for: **CABLEFORM**

CABLEFORM

CABLEFORM

Type: i. 1100-DPCO
Tip size: Ø 16 mm

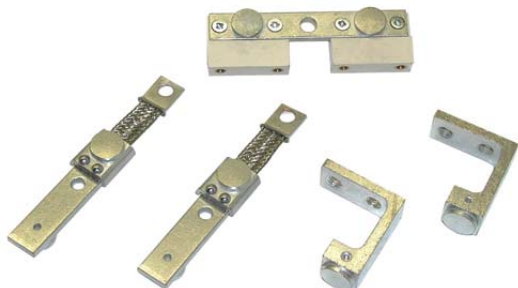

REF 133TA3663

Type: j. 1100-DPCO- SPECIAL CLARK
Tip size: Ø 16 mm

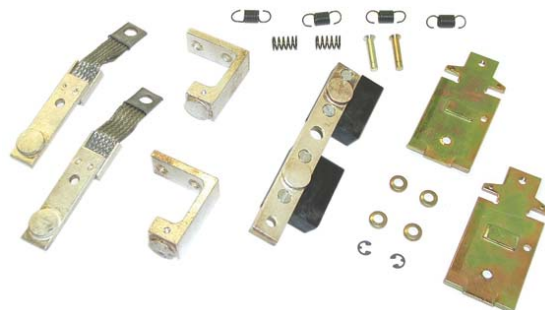

REF 133TA5590

Type: K. 1300-NO
Tip size: 8 X 12 mm



REF 133TA7484

Type: M. 1300-CO
Tip size: 8 X 12 mm



REF 133TA6020

Type: o. 1400-NO
Tip size: 15 X 18 mm



REF 133TA6766

Type: p. 1400-CO
Tip size: Ø 16 mm



REF 133TA6751

Look up
these parts via





GENERAL ELECTRIC

GENERAL ELECTRIC

TOTAL SOURCE[®]

Look up
these parts via

PS ProductSearch

used for:
GENERAL ELECTRIC

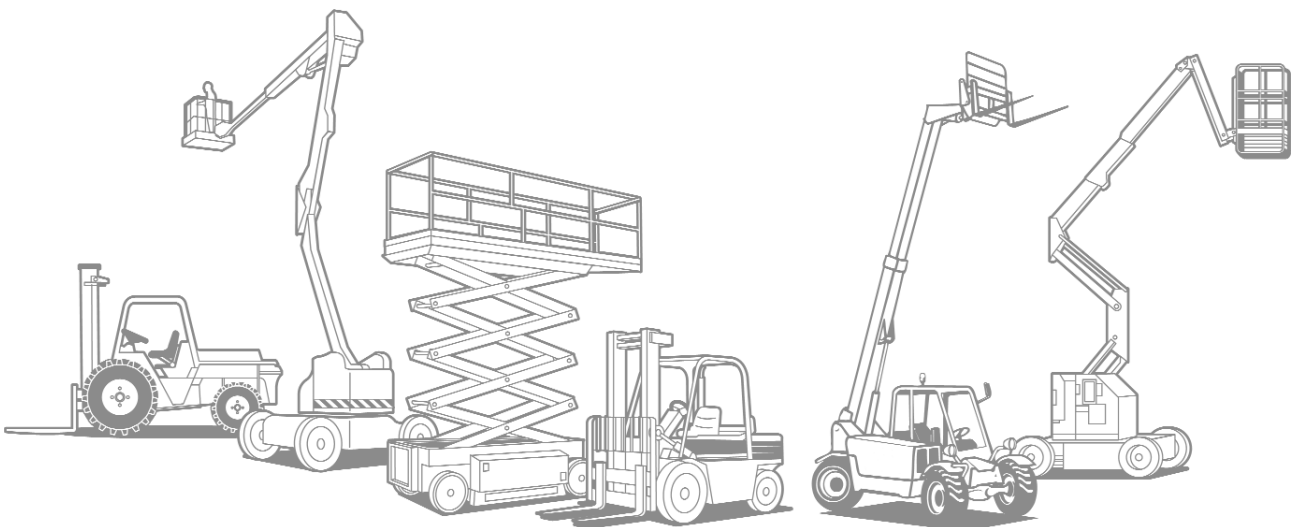



CONTACTS

For all our latest catalogue updates and company info: www.tvh.com

used for: **GENERAL ELECTRIC**

Type: 100A

Tip size: Ø 16 mm
Length: 12,7 mm
Number of tips: 1



REF 138TA5992

Type: A1 : CTRA700/710

Tip size: Ø 15,9 mm
Width: 15,9 mm
Length: 102 mm
Number of tips: 1



REF 138TA6002

Type: A2 : CTRA700/710 NEW STYLE

Tip size: Ø 12,7 mm
Width: 16 mm
Length: 102 mm
Number of tips: 1



REF 138TA6301

Type: B1 : CTRA700/710

Tip size: Ø 15,9 mm
Width: 15,9 mm
Length: 80 mm
Number of tips: 1

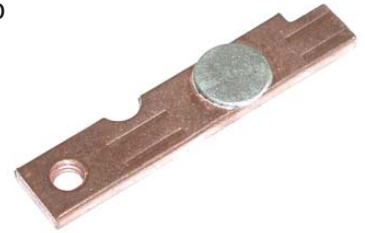

REF 138TA6017

Type: B2 : CTRA700/710 NEW STYLE

Tip size: Ø 12,7 mm
Width: 15,9 mm
Length: 80 mm
Number of tips: 1



REF 138TA6315

Type: C1 : CTRA700/710

Tip size: Ø 15,9 mm
Width: 15,9 mm
Length: 80 mm
Number of tips: 1

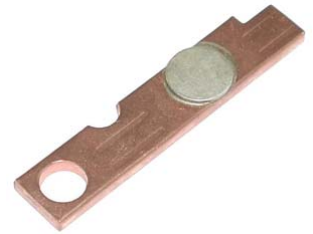

REF 109TA9180

Type: CTRA801/811

Tip size: Ø 10 mm
Width: 19 mm
Length: 75 mm
Number of tips: 1



REF 138TA6010

Type: CTRA801/811

Tip size: Ø 10 mm
Width: 19 mm
Length: 75 mm
Number of tips: 1



REF 138TA6011

Type: CTRA801/811

Tip size: Ø 10 mm
Width: 19 mm
Length: 80 mm
Number of tips: 1

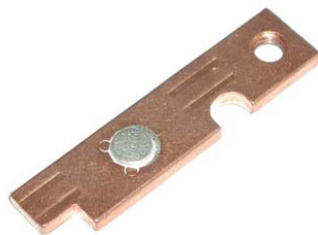

REF 138TA6012

Type: CTRA801/811

Tip size: Ø 10 mm
Width: 19 mm
Length: 80 mm
Number of tips: 1



REF 138TA6009

Type: CTRA801/811

Tip size: Ø 10 mm
Width: 19 mm
Length: 80 mm
Number of tips: 1



REF 138TA6007

Type: CTRA801/811

Tip size: Ø 10 mm
Width: 19 mm
Length: 80 mm
Number of tips: 1



REF 109TA9316

Type: CTRA801/811

Tip size: Ø 10 mm
Width: 19 mm
Length: 103 mm
Number of tips: 1



REF 138TA6008

Type: CTRA801/811

Tip size: Ø 10 mm
Width: 25 mm
Length: 70 mm
Number of tips: 2



REF 138TA6006

GENERAL ELECTRIC

GENERAL ELECTRIC

CONTACTS



For all our latest catalogue updates and company info: www.tvh.com

used for: **GENERAL ELECTRIC**

Type: CTTA 300

Tip size: Ø 15,9 mm
Width: 19 mm
Length: 73 mm
Number of tips: 1



REF 138TA6057

Type: CTTA 300

Tip size: Ø 15,9 mm
Width: 19 mm
Length: 73 mm
Number of tips: 1



REF 138TA6063

Type: CTTA 300

Tip size: Ø 15,9 mm
Width: 19 mm
Length: 135 mm
Number of tips: 2

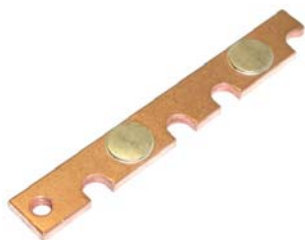

REF 138TA6062

Type: CTTA100

Tip size: Ø 10,3 mm
Width: 19 mm
Length: 54 mm
Number of tips: 2



REF 110TA1315

Type: CTTA100AA

Tip size: Ø 10,3 mm
Width: 12,7 mm
Length: 73 mm
Number of tips: 1



REF 138TA6056

Type: CTTA100AA

Tip size: Ø 10,3 mm
Width: 12,7 mm
Length: 73 mm
Number of tips: 1



REF 138TA6058

Type: CTTA100AH

Tip size: Ø 10,3 mm
Width: 12,7 mm
Length: 93 mm
Number of tips: 1



REF 138TA6050

Type: CTTA104/154

Tip size: Ø 7,5 mm
Width: 12,7 mm
Length: 73 mm
Number of tips: 1



REF 138TA6030

Type: CTTA104/154

Tip size: Ø 7,5 mm
Width: 12,7 mm
Length: 73 mm
Number of tips: 1



REF 138TA6043

Type: CTTA104/154

Tip size: Ø 7,5 mm
Width: 12,7 mm
Length: 135 mm
Number of tips: 2



REF 138TA6032

Type: CTTA150

Tip size: Ø 12,7 mm
Width: 19 mm
Length: 64,8 mm
Number of tips: 2



REF 138TA6227

Type: CTTA150/158

Tip size: Ø 12,7 mm
Width: 19 mm
Length: 54 mm
Number of tips: 2



REF 138TA6031

Type: CTTA150AA/158

Tip size: Ø 12,7 mm
Width: 12,7 mm
Length: 73 mm
Number of tips: 1



REF 138TA6045

Type: CTTA150AA/158

Tip size: Ø 12,7 mm
Width: 12,8 mm
Length: 73 mm
Number of tips: 1



REF 138TA5915

GENERAL ELECTRIC

GENERAL ELECTRIC



CONTACTS

For all our latest catalogue updates and company info: www.tvh.com

used for: **GENERAL ELECTRIC**

Type: CTTA150AH

Tip size: Ø 12,7 mm
Width: 12,7 mm
Length: 93 mm
Number of tips: 1

REF 138TA6029



Type: CTTA158

Tip size: Ø 12,7 mm
Width: 12,7 mm
Length: 73 mm
Number of tips: 1

REF 138TA6055



Type: CTTA158

Tip size: Ø 12,7 mm
Width: 12,7 mm
Length: 73 mm
Number of tips: 1

REF 110TA1338

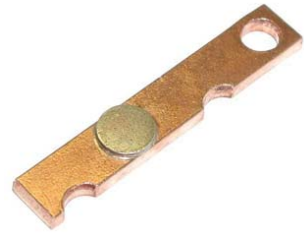

Type: CTTA158

Tip size: Ø 12,7 mm
Width: 12,7 mm
Length: 135 mm
Number of tips: 2

REF 110TA1352



Type: CTTA300

Tip size: Ø 10 mm
Width: 19 mm
Length: 64 mm
Number of tips: 2

REF 138TA6312



Type: CTTA300

Tip size: Ø 15,9 mm
Width: 19 mm
Length: 54,2 mm
Number of tips: 2

REF 138TA5910



Type: CTTA300

Tip size: Ø 15,9 mm
Width: 19 mm
Length: 64,4 mm
Number of tips: 2

REF 110TA1002



Type: CTTA300AA

Tip size: Ø 15,9 mm
Width: 19 mm
Length: 73 mm
Number of tips: 1

REF 110TA1141



Type: CTTA300AH

Tip size: Ø 15,9 mm
Width: 19 mm
Length: 92,5 mm
Number of tips: 1

REF 138TA6297

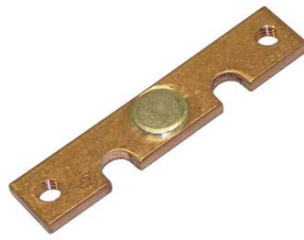

Type: CTTA304

Tip size: Ø 10,4 mm
Width: 19 mm
Length: 73 mm
Number of tips: 1

REF 138TA6046



Type: CTTA304

Tip size: Ø 10,4 mm
Width: 19 mm
Length: 73 mm
Number of tips: 1

REF 138TA6048



Type: CTTA304

Tip size: Ø 10,4 mm
Width: 19 mm
Length: 73 mm
Number of tips: 1

REF 138TA6047



Type: CTTA304

Tip size: Ø 10,4 mm
Width: 19 mm
Length: 73 mm
Number of tips: 1

REF 109TA9841



Type: CTTA304

Tip size: Ø 10,4 mm
Width: 19 mm
Length: 135 mm
Number of tips: 2

REF 138TA6049



GENERAL ELECTRIC

GENERAL ELECTRIC

CONTACTS



For all our latest catalogue updates and company info: www.tvh.com

used for: **GENERAL ELECTRIC**

Type: D1 : CTRA700/710

Tip size: Ø 15,9 mm
Width: 16 mm
Length: 82 mm
Number of tips: 1



REF 138TA6299

Type: D2 : CTRA700/710 NEW STYLE

Tip size: Ø 12,7 mm
Width: 16 mm
Length: 82 mm
Number of tips: 1



REF 138TA6326

Type: E1 : CTRA700/710

Tip size: Ø 15,9 mm
Width: 25,4 mm
Length: 63 mm
Number of tips: 2



REF 138TA6003

Type: E2 : CTRA 700/710 NEW STYLE

Tip size: Ø 12,7 mm
Width: 25,4 mm
Length: 63 mm
Number of tips: 2



REF 138TA6300

Type: F1 : CTRA700/710

Tip size: Ø 15,9 mm
Width: 16 mm
Length: 80,2 mm
Number of tips: 1



REF 109TA9628

Type: F2 : CTRA700/710 NEW STYLE

Tip size: Ø 12,7 mm
Width: 16 mm
Length: 80 mm
Number of tips: 1



REF 138TA6332

Type: G1 : CTRA701/711

Tip size: Ø 10 mm
Width: 15,9 mm
Length: 102 mm
Number of tips: 1



REF 138TA5986

Type: G2 : CTRA 701/711 NEW STYLE

Tip size: Ø 7,5 mm
Width: 16 mm
Length: 102 mm
Number of tips: 1



REF 138TA6339

Type: H1 : CTRA701/711

Tip size: Ø 10 mm
Width: 15,9 mm
Length: 74 mm
Number of tips: 1



REF 138TA5999

Type: H2 : CTRA 701/711 NEW STYLE

Tip size: Ø 7,5 mm
Width: 15,9 mm
Length: 74 mm
Number of tips: 1



REF 138TA6340

Type: I1 : CTRA701/711

Tip size: Ø 10 mm
Width: 15,9 mm
Length: 74 mm
Number of tips: 1



REF 138TA6019

Type: I2 : CTRA710/711 NEW STYLE

Tip size: Ø 7,5 mm
Width: 15,9 mm
Length: 74 mm
Number of tips: 1



REF 122TA7659

Type: IC2800M610-TYPE WITH WINGS

Tip size: 8 X 9 mm
Width: 9,2 mm
Length: 52 mm
Number of tips: 2



REF 138TA5874

Type: IC2800M610/611

Tip size: 8 X 9 mm
Width: 12,7 mm
Length: 67,6 mm
Number of tips: 1

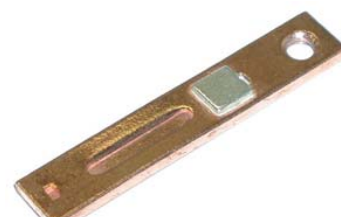

REF 138TA5875

GENERAL ELECTRIC

GENERAL ELECTRIC



CONTACTS

For all our latest catalogue updates and company info: www.tvh.com

used for: **GENERAL ELECTRIC**

Type: IC2800M611

Tip size: 8 X 9 mm
Width: 12,7 mm
Length: 83 mm
Number of tips: 1



REF 138TA5899

Type: IC2800M611-STANDARD TYPE

Tip size: 8 X 9 mm
Width: 9,2 mm
Length: 52 mm
Number of tips: 4

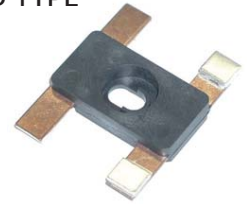

REF 138TA5896

Type: IC2800M611-TYPE WINGS

Tip size: 8 X 9 mm
Width: 9,2 mm
Length: 52 mm
Number of tips: 4



REF 122TA7639

Type: IC800M210

Tip size: Ø 15,9 mm
Length: 11,6 mm
Number of tips: 1



REF 138TA5852

Type: J1 : CTRA701/711

Tip size: Ø 10 mm
Width: 15,9 mm
Length: 80 mm
Number of tips: 1



REF 138TA5985

Type: J2 : CTRA 701/711 NEW STYLE

Tip size: Ø 7,5 mm
Width: 16 mm
Length: 79,5 mm
Number of tips: 1



REF 138TA6316

Type: K1 : CTRA701/711

Tip size: Ø 10 mm
Width: 15,9 mm
Length: 80 mm
Number of tips: 1



REF 138TA5988

Type: K2 : CTRA701/711 NEW STYLE

Tip size: Ø 7,5 mm
Width: 15,9 mm
Length: 80 mm
Number of tips: 1



REF 138TA6328

Type: L1 : CTRA701/711

Tip size: Ø 10 mm
Width: 15,9 mm
Length: 80 mm
Number of tips: 1



REF 138TA5987

Type: M1 : CTRA701/711

Tip size: Ø 10 mm
Width: 15,9 mm
Length: 80 mm
Number of tips: 1



REF 138TA5984

Type: M2 : CTRA 701/711 NEW STYLE

Tip size: Ø 7,5 mm
Width: 16 mm
Length: 80 mm
Number of tips: 1



REF 138TA6347

Type: N1 : CTRA701/711

Tip size: Ø 10 mm
Width: 25,4 mm
Length: 63 mm
Number of tips: 2



REF 138TA5998

Type: O1 : CTRA702/712

Tip size: Ø 15,9 mm
Width: 15,9 mm
Length: 75 mm
Number of tips: 1



REF 109TA9165

Type: O2 : CTRA702/712 NEW STYLE

Tip size: Ø 12,7 mm
Width: 15,9 mm
Length: 75 mm
Number of tips: 1



REF 138TA6329

GENERAL ELECTRIC

GENERAL ELECTRIC

CONTACTS



For all our latest catalogue updates and company info: www.tvh.com

used for: **GENERAL ELECTRIC**

Type: P1 : CTRA702/712

Tip size: Ø 15,9 mm
Width: 15,9 mm
Length: 75 mm
Number of tips: 1



REF 138TA6018

Type: Q1 : CTRA800/810

Tip size: Ø 19 mm
Width: 19 mm
Length: 103 mm
Number of tips: 1



REF 138TA6001

Type: Q2 : CTRA800/810 NEW STYLE

Tip size: Ø 15,9 mm
Width: 19 mm
Length: 104 mm
Number of tips: 1



REF 138TA6303

Type: R1 : CTRA800/810

Tip size: Ø 19 mm
Width: 19 mm
Length: 80 mm
Number of tips: 1



REF 138TA6015

Type: R2 : CTRA800/810 NEW STYLE

Tip size: Ø 15,9 mm
Width: 19 mm
Length: 80 mm
Number of tips: 1



REF 138TA6304

Type: S1 : CTRA800/810

Tip size: Ø 19 mm
Width: 19 mm
Length: 80 mm
Number of tips: 1



REF 138TA6013

Type: S2 : CTRA800/810 NEW STYLE

Tip size: Ø 15,9 mm
Width: 19,2 mm
Length: 80 mm
Number of tips: 1



REF 138TA6345

Type: T1 : CTRA800/810

Tip size: Ø 19 mm
Width: 19 mm
Length: 80 mm
Number of tips: 1

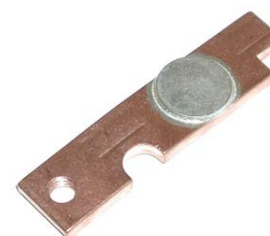

REF 138TA5989

Type: T2 : CTRA800/810 NEW STYLE

Tip size: Ø 15,9 mm
Width: 19 mm
Length: 80 mm
Number of tips: 1



REF 138TA6327

Type: U1 : CTRA800/810

Tip size: Ø 19 mm
Width: 19 mm
Length: 80 mm
Number of tips: 1



REF 138TA6016

Type: U2 : CTRA800/810 NEW STYLE

Tip size: Ø 15,9 mm
Width: 19 mm
Length: 80 mm
Number of tips: 1



REF 138TA6331

Type: V1 : CTRA800/810

Tip size: Ø 19 mm
Width: 25,4 mm
Length: 70 mm
Number of tips: 2



REF 138TA6000

Type: W1 : CTRA812

Tip size: Ø 19 mm
Width: 19 mm
Length: 73 mm
Number of tips: 1



REF 138TA6014

Type: W2 : CTRA812 NEW STYLE

Tip size: Ø 15,9 mm
Width: 19 mm
Length: 73 mm
Number of tips: 1



REF 138TA6322

GENERAL ELECTRIC

GENERAL ELECTRIC



CONTACTS

For all our latest catalogue updates and company info: www.tvh.com

used for: **GENERAL ELECTRIC**

Type: X1 : CTRA812

Tip size: Ø 19 mm
Width: 19 mm
Length: 73 mm
Number of tips: 1



REF 138TA6041

Type: X2 : CTRA812 NEW STYLE

Tip size: Ø 15,9 mm
Width: 19 mm
Length: 73 mm
Number of tips: 1



REF 138TA6330

Type: Y1 : CTTA304

Tip size: Ø 10,4 mm
Width: 19,2 mm
Length: 65 mm
Number of tips: 2



REF 138TA6302

Type: Y2 : CTTA 304 NEW STYLE

Tip size: Ø 7,5 mm
Width: 19 mm
Length: 64,5 mm
Number of tips: 2



REF 138TA6294

GENERAL ELECTRIC

GENERAL ELECTRIC





For all our latest catalogue updates and company info: www.tvh.com

used for: **GENERAL ELECTRIC**

Type: 100A
Tip size: Ø 16 mm



REF 133TA4115

Type: 200A
Tip size: Ø 22,2 mm



REF 138TA6501

Type: CTRA 800 AA
Tip size: Ø 19 mm



REF 122TA7672

Type: CTRA 800 AH
Tip size: Ø 19 mm



REF 122TA7674

Type: CTRA 800AE
Tip size: Ø 15,9 mm

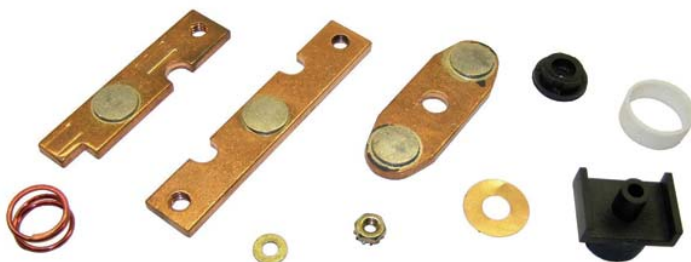

REF 133TA7709

Type: CTRA700/710 NEW STYLE
Tip size: Ø 12,7 mm

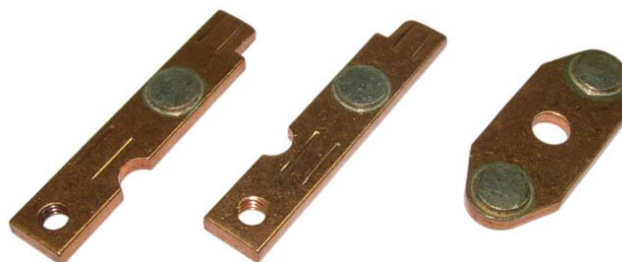

REF 138TA6530

Type: CTRA700AA
Tip size: Ø 15,9 mm



REF 133TA3496

Type: CTRA700AA-CAT
Tip size: Ø 15,9 mm



REF 133TA6671

CONTACT KITS

For all our latest catalogue updates and company info: www.tvh.com

used for: **GENERAL ELECTRIC**

Type: CTRA700AE
Tip size: Ø 15,9 mm



REF 133TA4182

Type: CTRA700AH
Tip size: Ø 15,9 mm

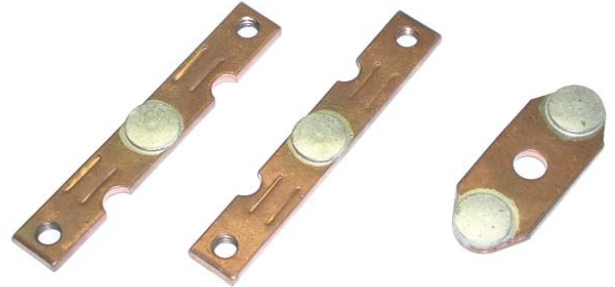

REF 138TA6500

Type: CTRA701-CLARK
Tip size: Ø 10 mm



REF 133TA3817

Type: CTRA701BB
Tip size: Ø 10 mm



REF 133TA3526

Type: CTRA701BD
Tip size: Ø 10 mm

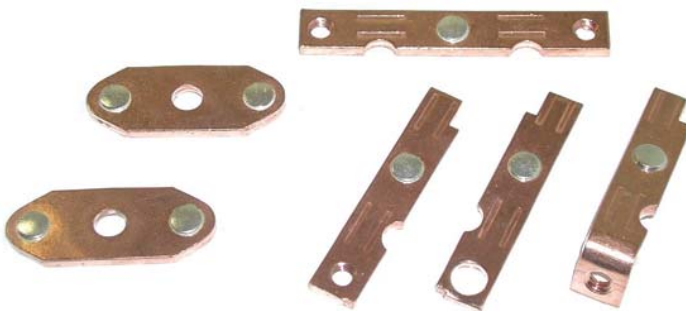

REF 133TA3695

Type: CTRA701BE
Tip size: Ø 10 mm

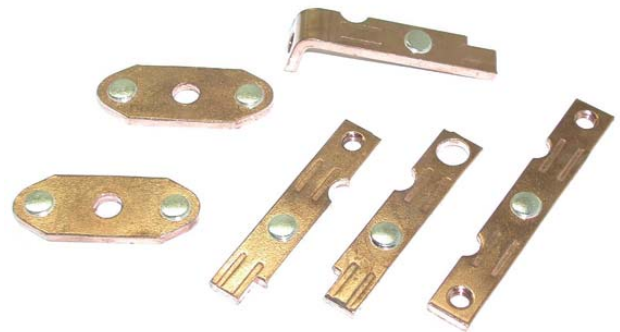

REF 133TA4253

Type: CTRA701BE - YALE
Tip size: Ø 10 mm

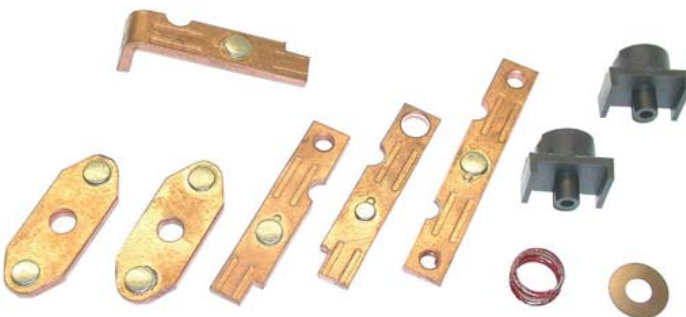

REF 133TA5096

Type: CTRA702BD
Tip size: Ø 15,9 mm



REF 133TA6085

CONTACT KITS



For all our latest catalogue updates and company info: www.tvh.com

used for: **GENERAL ELECTRIC**

Type: CTRA702BE
Tip size: \varnothing 15,9 mm

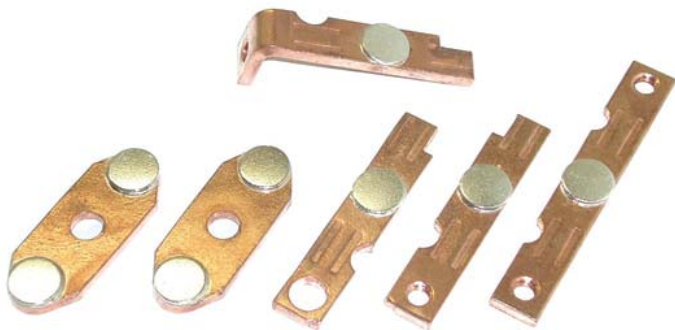

REF 138TA6504

Type: CTRA800AA
Tip size: \varnothing 19 mm

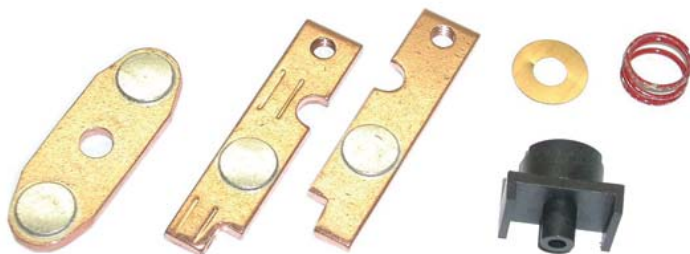

REF 133TA5075

Type: CTRA800AA
Tip size: \varnothing 19 mm



REF 133TA4351

Type: CTRA800AE
Tip size: \varnothing 19 mm

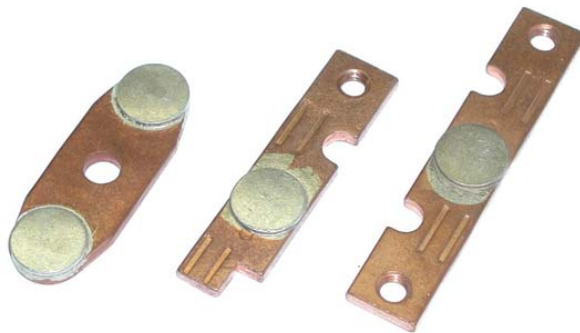

REF 110TA3616

Type: CTRA800AH
Tip size: \varnothing 19 mm

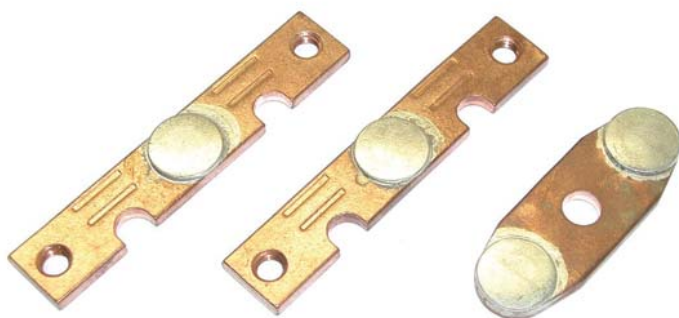

REF 133TA3983

Type: CTRA801BD
Tip size: \varnothing 10 mm



REF 133TA5598

Type: CTRA802BD
Tip size: \varnothing 19 mm



REF 133TA4373

Type: CTRA802BE
Tip size: \varnothing 19 mm



REF 138TA6499

CONTACT KITS

For all our latest catalogue updates and company info: www.tvh.com

used for: **GENERAL ELECTRIC**

Type: CTTA 304
Tip size: Ø 10,3 mm

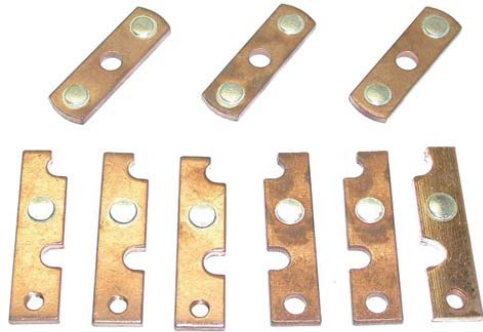

REF 133TA3840

Type: CTTA100AA
Tip size: Ø 10,3 mm



REF 133TA5926

Type: CTTA100AH
Tip size: Ø 10,3 mm

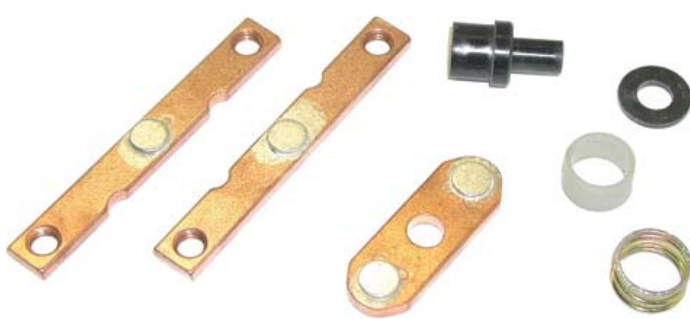

REF 133TA4369

Type: CTTA100AH
Tip size: Ø 10,3 mm

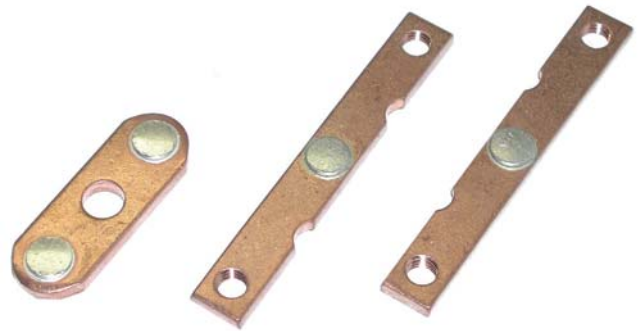

REF 133TA6627

Type: CTTA150AA
Tip size: Ø 10,3 mm

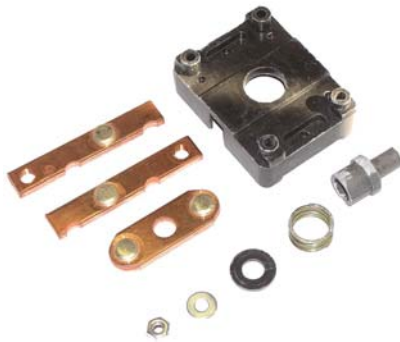

REF 133TA7571

Type: CTTA150AA
Tip size: Ø 12,7 mm



REF 110TA3753

Type: CTTA150AA
Tip size: Ø 12,7 mm



REF 133TA3807

Type: CTTA150AA
Tip size: Ø 12,7 mm



REF 133TA6014



used for: GENERAL ELECTRIC

Type: CTTA150AA
Tip size: Ø 12,7 mm



REF 133TA3363

Type: CTTA150AH
Tip size: Ø 12,7 mm

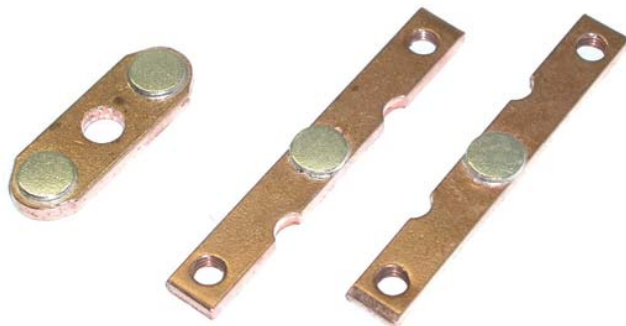

REF 133TA4220

Type: CTTA150AH
Tip size: Ø 12,7 mm



REF 133TA7546

Type: CTTA154FR
Tip size: Ø 7,6 mm

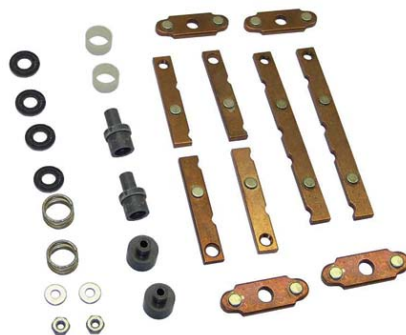

REF 138TA6529

Type: CTTA154FR
Tip size: Ø 7,6 mm

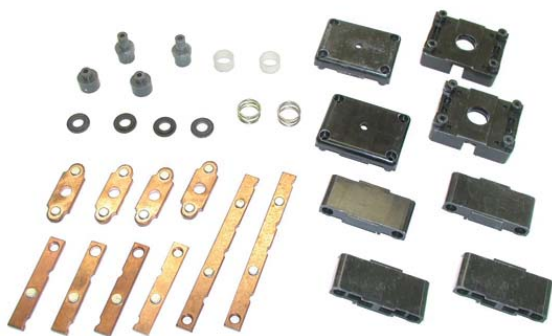

REF 133TA5296

Type: CTTA154FR
Tip size: Ø 7,6 mm

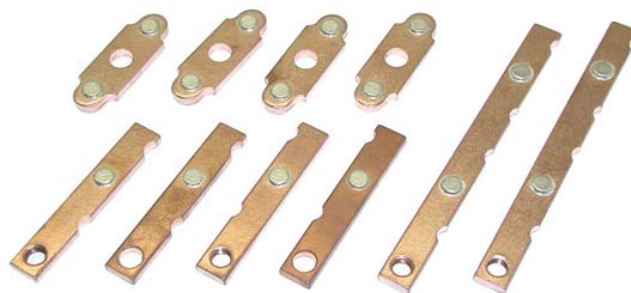

REF 133TA4445

Type: CTTA154FR
Tip size: Ø 12,7 mm



REF 133TA5995

Type: CTTA158FR
Tip size: Ø 12,7 mm

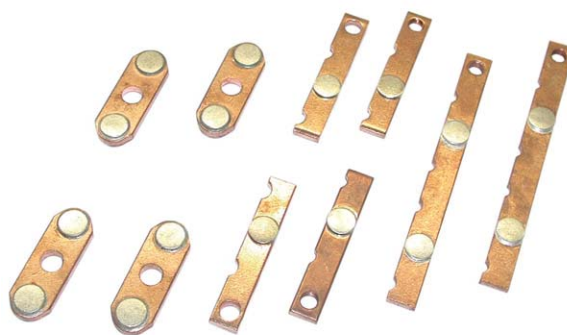

REF 133TA7463

GENERAL ELECTRIC

GENERAL ELECTRIC

CONTACT KITS

For all our latest catalogue updates and company info: www.tvh.com

used for: **GENERAL ELECTRIC**

Type: CTTA300AA
Tip size: Ø 15,9 mm



REF 138TA6502

Type: CTTA300AA
Tip size: Ø 15,9 mm



REF 133TA6173

Type: CTTA300AH
Tip size: Ø 15,9 mm



REF 133TA3944

Type: CTTA300AH
Tip size: Ø 15,9 mm



REF 110TA6748

Type: CTTA304FR
Tip size: Ø 10,4 mm



REF 133TA5391

Type: CTTA304FR
Tip size: Ø 10,4 mm

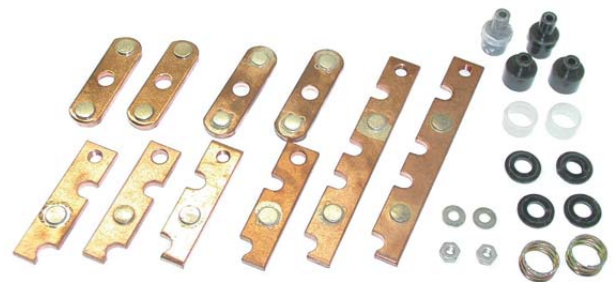

REF 133TA5056

Type: IC2800M210
Tip size: Ø 15,9 mm



REF 133TA3676

Type: IC2800M250
Tip size: Ø 15,5 mm



REF 133TA4515



used for: **GENERAL ELECTRIC**

Type: IC2800M420
Tip size: Ø 15,5 mm



REF 133TA7006

Type: IC2800M610
Tip size: 8 X 9 mm



REF 133TA5120

Type: IC2800M610
Tip size: 8 X 9 mm

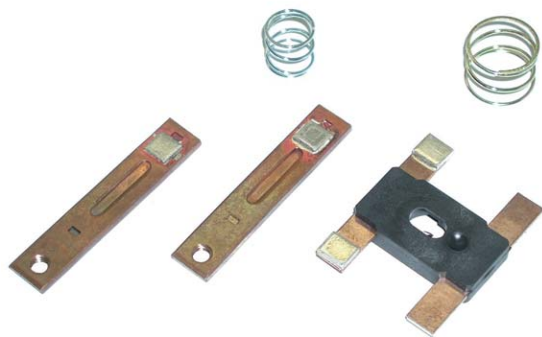

REF 133TA5840

Type: IC2800M610 - TYPE WINGS
Tip size: 8 X 9 mm

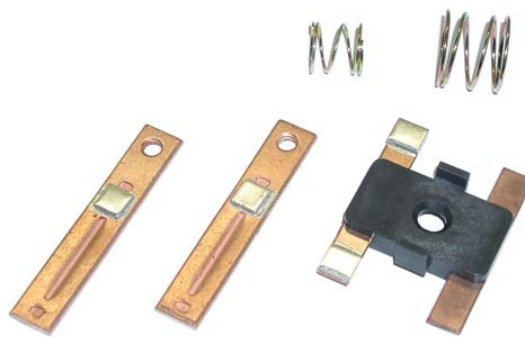

REF 133TA5136

Type: IC2800M611
Tip size: 8 X 9 mm

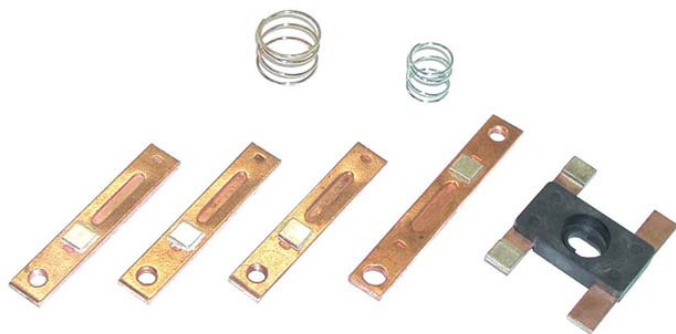

REF 133TA7524

Type: YALE
Tip size: Ø 15,9 mm



REF 133TA6204

Look up
these parts via





TOTALSOURCE®

Look up
these parts via

PS ProductSearch

used for:
HARDELLET

HARDELLET

HARDELLET

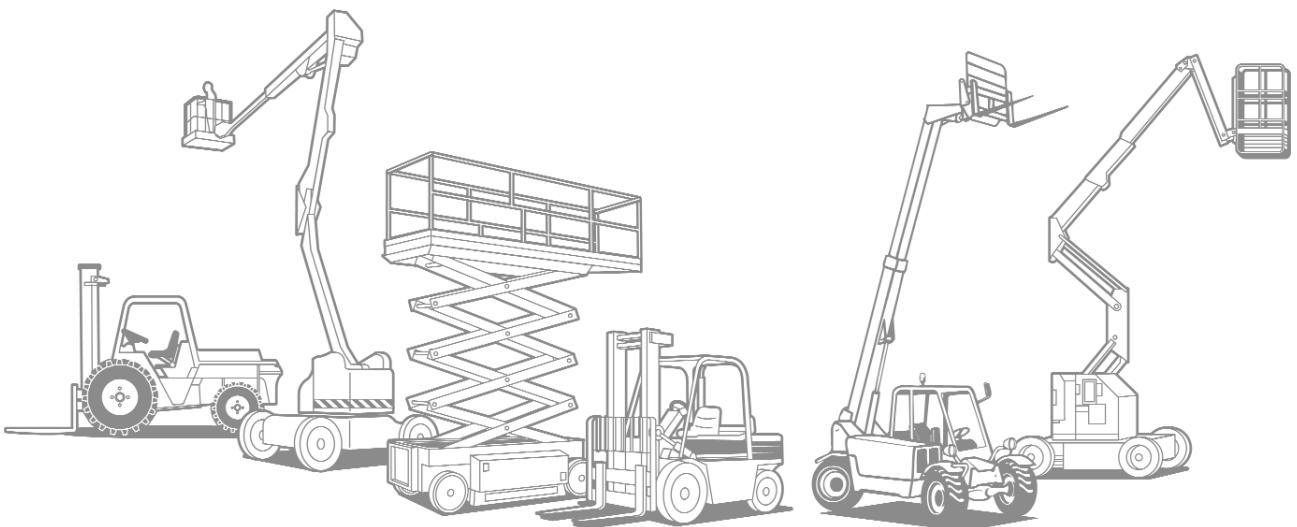



CONTACTS

For all our latest catalogue updates and company info: www.tvh.com

used for: **HARDELLET**

Type: C/I24350

Tip size: 7,7 X 15 mm
Width: 16,3 mm
Length: 28,5 mm
Number of tips: 1



REF 132TA2059

Type: C20000

Tip size: Ø 8,5 mm
Width: 10,3 mm
Length: 46,2 mm
Number of tips: 2



REF 134TA2279

Type: C20000

Tip size: Ø 8,8 mm
Width: 10 mm
Length: 10 mm
Number of tips: 1



REF 134TA2278

Type: C24100

Tip size: 6 X 12,2 mm
Width: 16,3 mm
Length: 28,5 mm
Number of tips: 1



REF 138TA6223

Type: DP20000

Tip size: Ø 8,8 mm
Width: 10 mm
Length: 36 mm
Number of tips: 1



REF 134TA2292

Type: IFH

Tip size: 4,9 X 12,2 mm
Length: 36 mm
Number of tips: 1



REF 110TA2884

Type: IFH

Tip size: 5,8 X 13 mm
Width: 20 mm
Length: 35,5 mm
Number of tips: 2



REF 110TA2883



HARDELLET

HARDELLET

CONTACT KITS



For all our latest catalogue updates and company info: www.tvh.com

used for: **HARDELLET**

Type: C1200
Tip size: \varnothing 12,6 mm



REF 133TA5879

Type: C20000
Tip size: \varnothing 8,5 mm



REF 133TA6403

Type: C23050
Tip size: 10 X 16 mm



REF 133TA4855

Type: C23100
Tip size: 6 X 12 mm

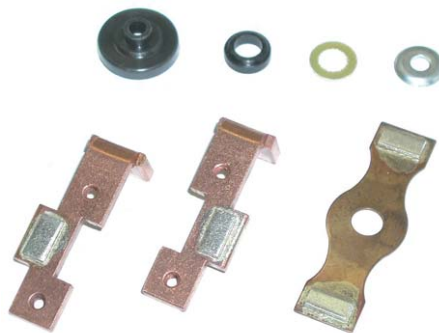

REF 133TA5807

Type: C24100
Tip size: 8,5 X 16,2 mm



REF 138TA6517

Type: C24150
Tip size: 5,9 X 12 mm



REF 133TA5561

Type: C24350
Tip size: 6 X 6 mm



REF 133TA5732

Type: CP24150 - BC24150
Tip size: 8 X 12 mm



REF 133TA6161

HARDELLET

HARDELLET

CONTACT KITS

For all our latest catalogue updates and company info: www.tvh.com

used for: **HARDELLET**

Type: CP24350 - BC24350
Tip size: 8 X 12 mm



REF 133TA5230

Type: DP20000
Tip size: Ø 8,5 mm



REF 133TA6275

Type: DP2200
Tip size: Ø 12,7 mm



REF 133TA6181

Type: I23050
Tip size: 8 X 15 mm

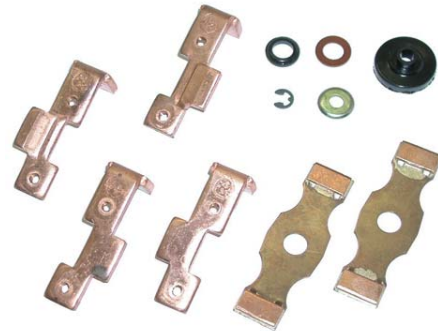

REF 133TA5870

Type: I23100
Tip size: 5,9 X 12 mm

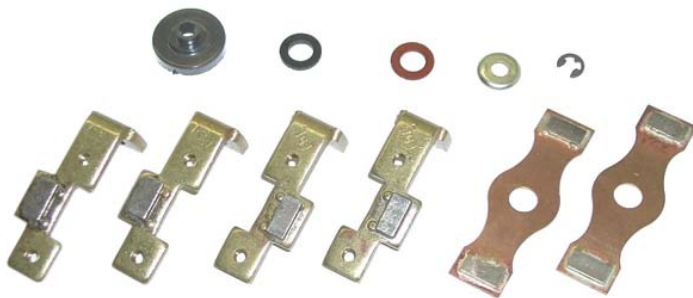

REF 133TA5705

Type: I24100
Tip size: 8,5 X 16 mm



REF 133TA5846

Type: I24350S
Tip size: 8 X 12,5 mm

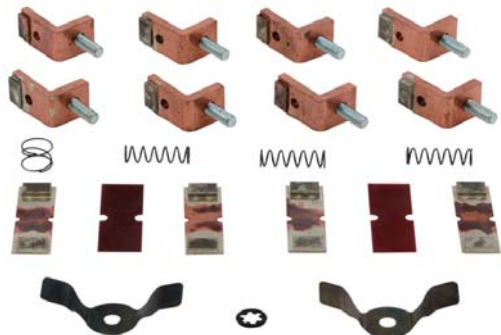

REF 108TA7959

Type: IFH
Tip size: 5 X 15,8 mm

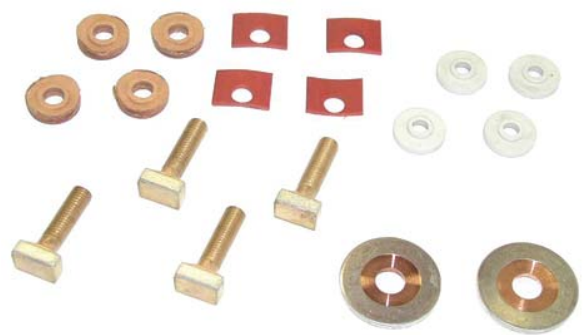

REF 106TA2332

HARDELLET

HARDELLET



For all our latest catalogue updates and company info: www.tvh.com

used for: **HARDELLET**

Type: RFH
Tip size: 5,2 X 16 mm



REF 108TA7901

HARDELLET

HARDELLET

Look up
these parts via

PS ProductSearch



TOTALSOURCE[®]

Look up
these parts via

PS ProductSearch

used for:
PRESTOLITE

PRESTOLITE

PRESTOLITE

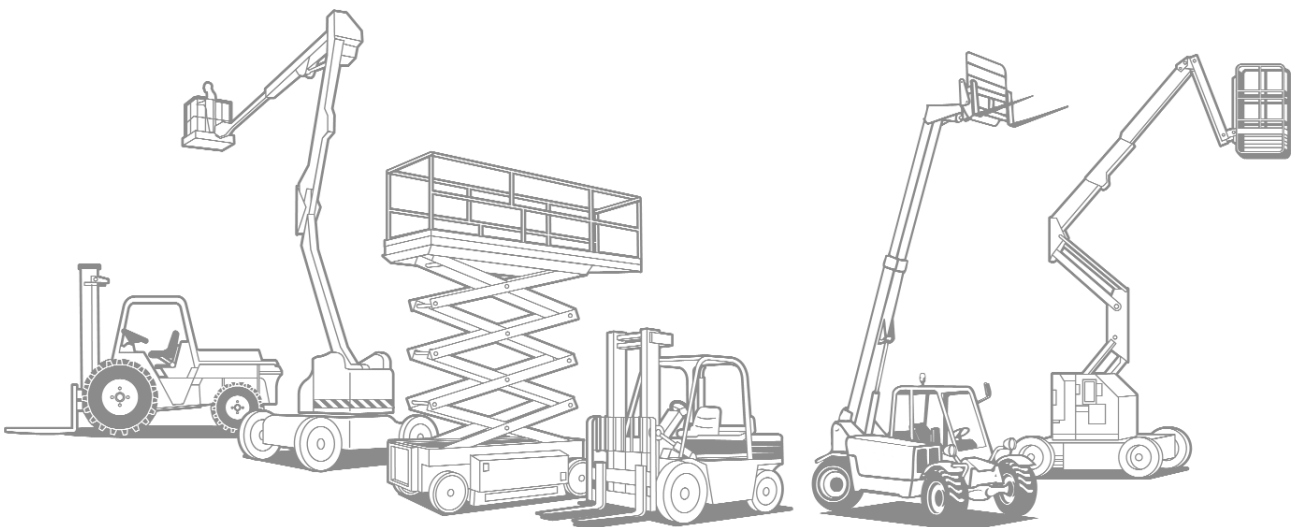



CONTACTS

For all our latest catalogue updates and company info: www.tvh.com

used for: **PRESTOLITE**

Type:

Tip size: Ø 12,6 mm
Width: 12,7 mm
Length: 64 mm
Number of tips: 1



REF 138TA6348

Type:

Tip size: Ø 12,7 mm
Width: 12,7 mm
Length: 42 mm
Number of tips: 1



REF 138TA6282

Type: 200A

Tip size: Ø 13 mm
Width: 15,6 mm
Length: 39,3 mm
Number of tips: 1



REF 138TA5855

Type: HB1

Tip size: Ø 12,7 mm
Width: 12,6 mm
Length: 62,7 mm
Number of tips: 1



REF 138TA5893

Type: HB1

Tip size: Ø 12,7 mm
Width: 12,8 mm
Length: 58 mm
Number of tips: 1



REF 138TA5884

Type: HB1

Tip size: Ø 12,7 mm
Width: 15 mm
Length: 30 mm
Number of tips: 1



REF 138TA5886

Type: HB1-CAT

Tip size: Ø 10,5 mm
Width: 13,3 mm
Length: 42,5 mm
Number of tips: 2



REF 138TA6285

Type: HB1/7

Tip size: Ø 12,7 mm
Width: 15 mm
Length: 47,6 mm
Number of tips: 2



REF 138TA5842

Type: HB111

Tip size: Ø 9,4 mm
Width: 11 mm
Length: 28 mm
Number of tips: 1



REF 116TA5824

Type: HB1KG

Tip size: Ø 12,7 mm
Width: 13 mm
Length: 84 mm
Number of tips: 1

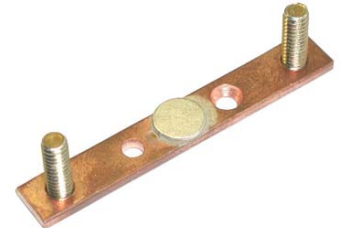

REF 138TA6186

Type: HB30

Tip size: Ø 19 mm
Width: 19 mm
Length: 74 mm
Number of tips: 1



REF 138TA5991

Type: HB30

Tip size: Ø 19 mm
Width: 19 mm
Length: 102 mm
Number of tips: 1



REF 138TA5891

Type: HB30/36

Tip size: Ø 19 mm
Width: 23 mm
Length: 68 mm
Number of tips: 2



REF 138TA5990

Type: HB30LA

Tip size: Ø 19 mm
Width: 19 mm
Length: 72 mm
Number of tips: 1



REF 138TA5892

PRESTOLITE

PRESTOLITE

CONTACTS



For all our latest catalogue updates and company info: www.tvh.com

used for: **PRESTOLITE**

Type: HB32

Tip size: Ø 19 mm
Width: 19,3 mm
Length: 68,5 mm
Number of tips: 1



REF 138TA6213

Type: HB36

Tip size: Ø 19 mm
Width: 42,4 mm
Length: 40,3 mm
Number of tips: 1



REF 138TA6353

Type: HB36

Tip size: Ø 19 mm
Width: 42,5 mm
Length: 52 mm
Number of tips: 1



REF 138TA6324

Type: HB401

Tip size: 9,5 X 9,5 mm
Width: 13,3 mm
Length: 45 mm
Number of tips: 2



REF 138TA5860

Type: HB401/407

Tip size: 9,5 X 9,5 mm
Width: 13 mm
Length: 40 mm
Number of tips: 2



REF 138TA5909

Type: HB401KE

Tip size: 9,5 X 9,5 mm
Width: 19 mm
Length: 35 mm
Number of tips: 2



REF 108TA5813

Type: HB401KP

Tip size: 9,5 X 9,5 mm
Width: 13,3 mm
Length: 35,6 mm
Number of tips: 2



REF 138TA6214

Type: HB407

Tip size: 9,8 X 9,8 mm
Width: 13 mm
Length: 30 mm
Number of tips: 4



REF 138TA6230

Type: HB407

Tip size: 9,5 X 9,5 mm
Width: 13 mm
Length: 34,5 mm
Number of tips: 4



REF 138TA5873

Type: HB407/409

Tip size: 9,5 X 9,5 mm
Width: 12,8 mm
Length: 30 mm
Number of tips: 4



REF 138TA5859

Type: HB431

Tip size: 9,5 X 9,5 mm
Width: 13,5 mm
Length: 31,5 mm
Number of tips: 2



REF 110TA2719

Type: HB431/437

Tip size: 9,5 X 9,5 mm
Width: 13,3 mm
Length: 40,2 mm
Number of tips: 2



REF 138TA5902

Type: HB437

Tip size: 9,5 X 9,5 mm
Width: 13 mm
Length: 30 mm
Number of tips: 4



REF 138TA6229

Type: HB70JC

Tip size: Ø 12,7 mm
Width: 15 mm
Length: 31 mm
Number of tips: 1



REF 138TA5835

PRESTOLITE

PRESTOLITE



CONTACTS

For all our latest catalogue updates and company info: www.tvh.com

used for: **PRESTOLITE**

Type: HB70JC

Tip size: Ø 12,7 mm
Width: 15 mm
Length: 35,8 mm
Number of tips: 1



REF 116TA5823

Type: HB70JC

Tip size: Ø 12,7 mm
Width: 27,6 mm
Length: 35,8 mm
Number of tips: 1



REF 116TA5822

Type: HB7KL

Tip size: Ø 12,7 mm
Width: 14,7 mm
Length: 38,8 mm
Number of tips: 1



REF 138TA6137

Type: HB7KL

Tip size: Ø 12,7 mm
Width: 15,5 mm
Length: 38,8 mm
Number of tips: 1

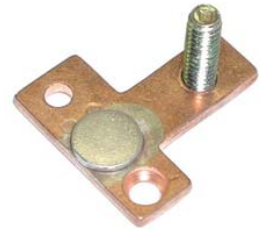

REF 138TA5897

Type: HB7KL

Tip size: Ø 12,7 mm
Width: 15,6 mm
Length: 36 mm
Number of tips: 1



REF 138TA5856

Type: HBSP102/HBSP103

Tip size: Ø 9,5 mm
Width: 10 mm
Length: 9 mm
Number of tips: 1



REF 138TA6295

Type: HBSP103

Tip size: Ø 9,5 mm
Width: 13 mm
Length: 42 mm
Number of tips: 4



REF 138TA6307

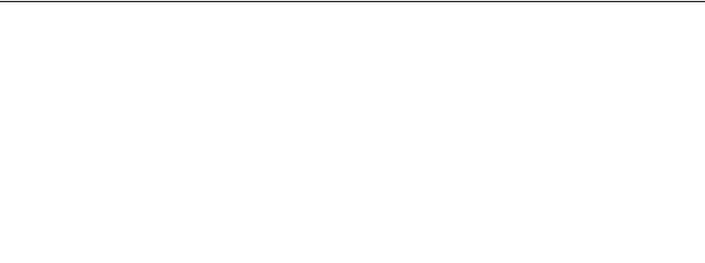

PRESTOLITE

PRESTOLITE

CONTACT KITS



For all our latest catalogue updates and company info: www.tvh.com

used for: **PRESTOLITE**

Type: HB111
Tip size: Ø 9,5 mm



REF 133TA5788

Type: HB111
Tip size: Ø 9,5 mm



REF 133TA5003

Type: HB117
Tip size: Ø 9,5 mm



REF 133TA3555

Type: HB117
Tip size: Ø 9,5 mm



REF 106TA2238

Type: HB1K
Tip size: Ø 12,7 mm



REF 133TA4388

Type: HB1KC/SC
Tip size: Ø 12,7 mm

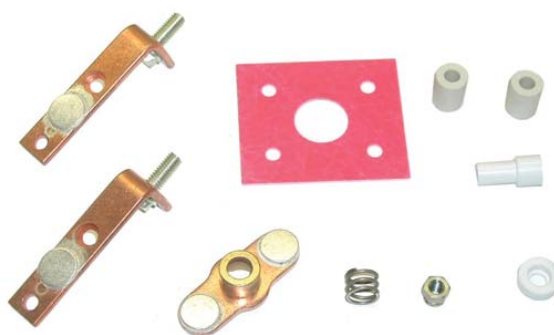

REF 133TA3424

Type: HB1KG
Tip size: Ø 12,7 mm



REF 133TA5454

Type: HB1KW
Tip size: Ø 12,7 mm



REF 133TA5105

PRESTOLITE

PRESTOLITE

CONTACT KITS

For all our latest catalogue updates and company info: www.tvh.com

used for: **PRESTOLITE**

Type: HB1SM
Tip size: Ø 12,7 mm

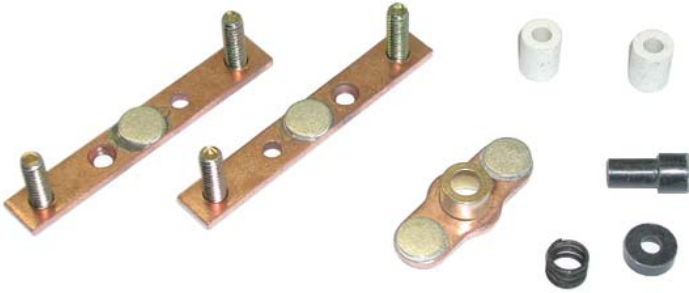

REF 133TA4039

Type: HB1UM
Tip size: Ø 12,7 mm

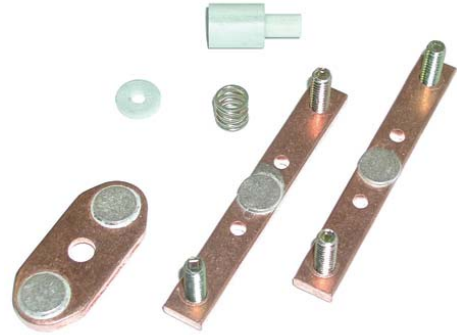

REF 138TA6511

Type: HB30
Tip size: Ø 19 mm

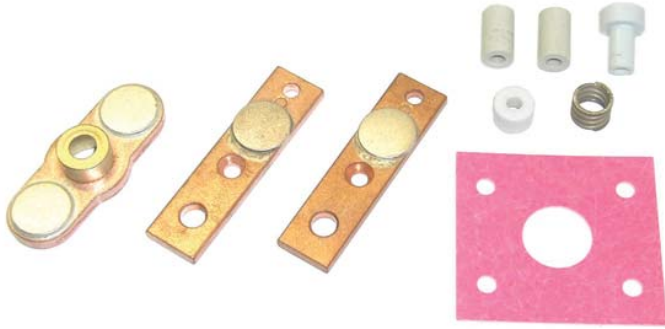

REF 133TA4143

Type: HB30
Tip size: Ø 19 mm

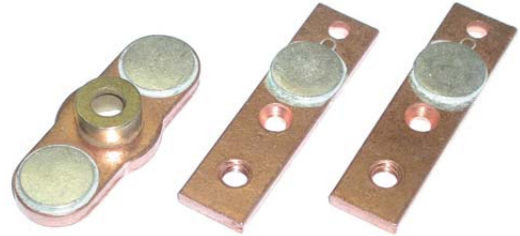

REF 133TA5341

Type: HB30KT
Tip size: Ø 19 mm



REF 110TA3630

Type: HB30LA
Tip size: Ø 19 mm



REF 111TA4050

Type: HB32K
Tip size: Ø 19 mm

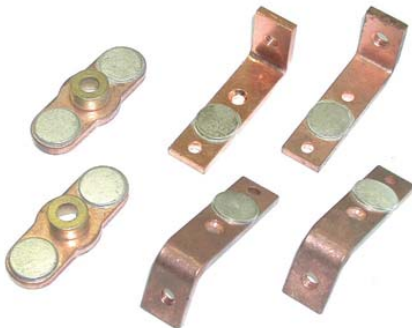

REF 133TA4805

Type: HB36
Tip size: Ø 19 mm

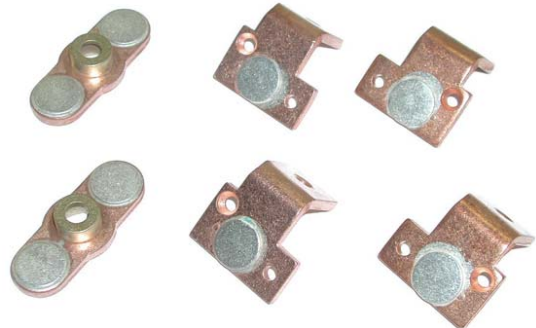

REF 133TA6105

PRESTOLITE

PRESTOLITE

CONTACT KITS



For all our latest catalogue updates and company info: www.tvh.com

used for: **PRESTOLITE**

Type: HB36
Tip size: \varnothing 19 mm



REF 133TA6066

Type: HB36KL
Tip size: \varnothing 19 mm



REF 110TA3589

Type: HB36KR
Tip size: \varnothing 19 mm

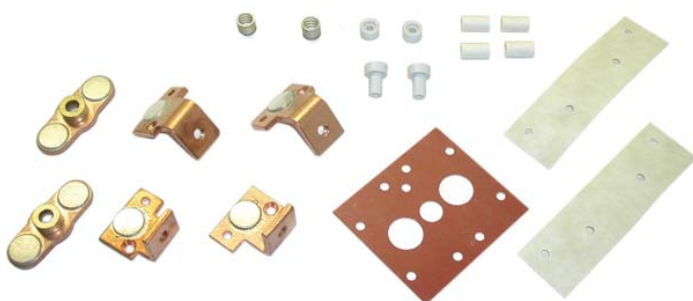

REF 133TA5521

Type: HB3KS
Tip size: \varnothing 12,7 mm

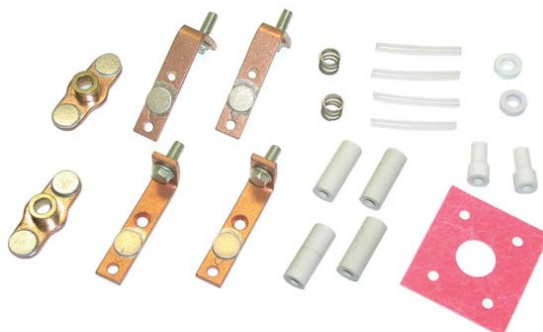

REF 138TA6507

Type: HB3KT
Tip size: \varnothing 9,5 mm

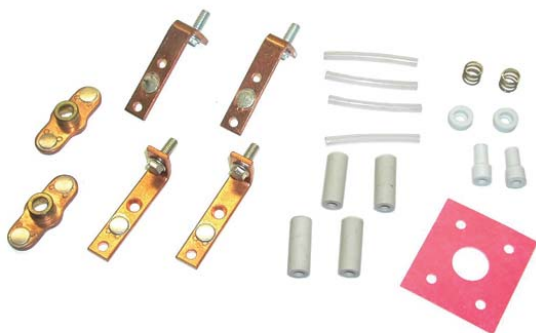

REF 108TA7845

Type: HB401
Tip size: 9,5 X 9,5 mm

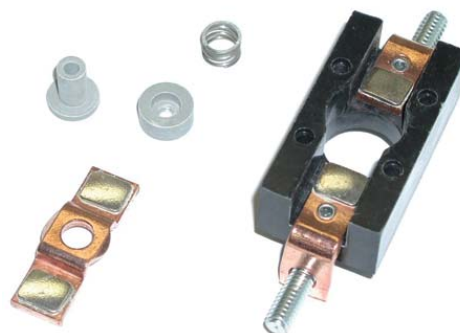

REF 133TA7335

Type: HB401
Tip size: 9,5 X 9,5 mm

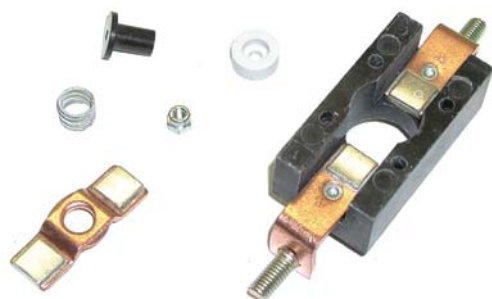

REF 133TA5149

Type: HB401KS
Tip size: 9,5 X 9,5 mm



REF 133TA5529

PRESTOLITE

PRESTOLITE

CONTACT KITS

For all our latest catalogue updates and company info: www.tvh.com

used for: **PRESTOLITE**

Type: HB403
Tip size: 9,5 X 9,5 mm

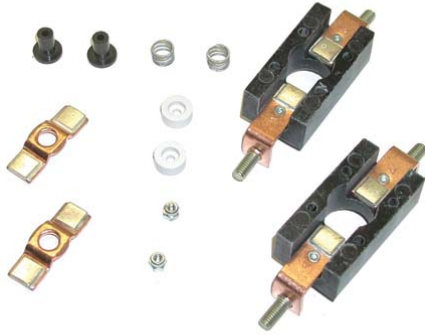

REF 133TA5856

Type: HB403 - CLARK
Tip size: 9,5 X 9,5 mm

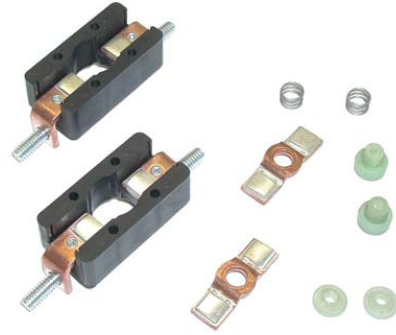

REF 133TA5819

Type: HB407
Tip size: 9,5 X 9,5 mm



REF 133TA6832

Type: HB407KF
Tip size: 9,5 X 9,5 mm

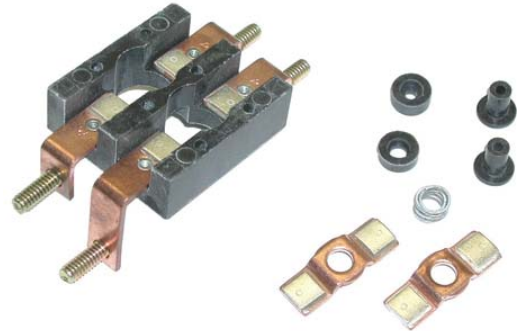

REF 133TA3450

Type: HB407SQ
Tip size: 9,5 X 9,5 mm

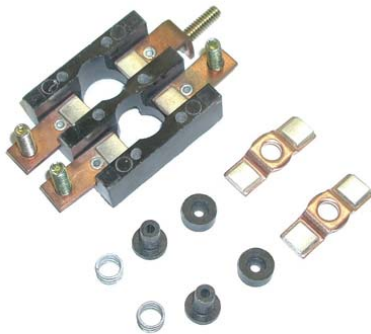

REF 110TA9050

Type: HB409KC
Tip size: 9,5 X 9,5 mm

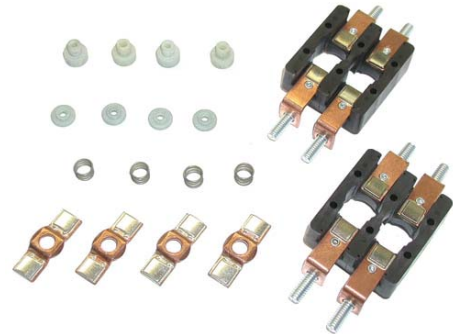

REF 133TA6385

Type: HB40X
Tip size: 9,5 X 9,5 mm

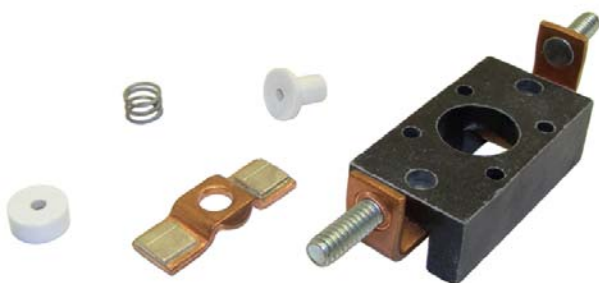

REF 110TA3659

Type: HB431
Tip size: 9,5 X 9,5 mm



REF 133TA7177

PRESTOLITE

PRESTOLITE

CONTACT KITS



For all our latest catalogue updates and company info: www.tvh.com

used for: **PRESTOLITE**

Type: HB431-CAT
Tip size: 9,5 X 9,5 mm

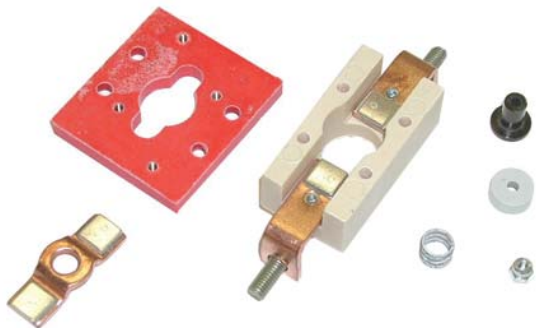

REF 108TA8021

Type: HB431KP
Tip size: 9,5 X 9,5 mm



REF 133TA4985

Type: HB433
Tip size: 9,5 X 9,5 mm

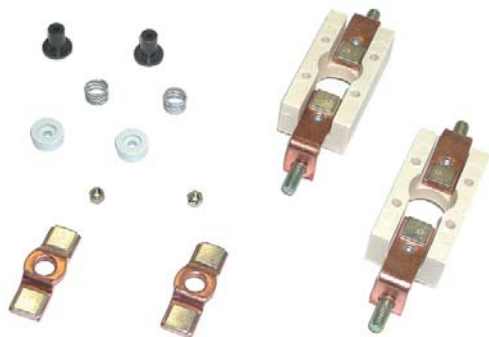

REF 133TA7455

Type: HB437K
Tip size: 9,5 X 9,5 mm

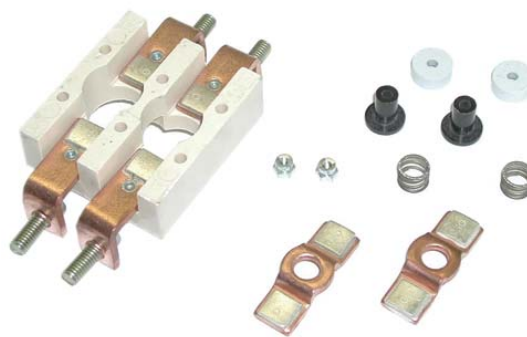

REF 133TA4582

Type: HB437KP
Tip size: 9,5 X 9,5 mm

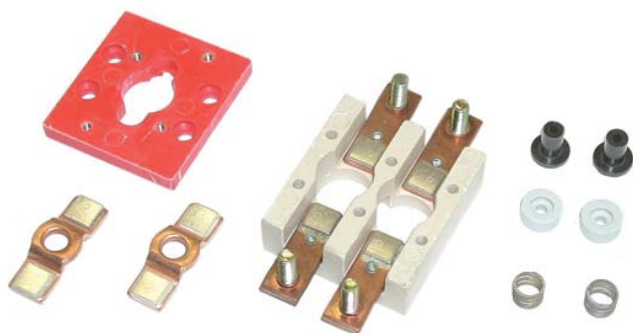

REF 133TA4826

Type: HB60KC
Tip size: Ø 19 mm



REF 133TA3612

Type: HB60SC
Tip size: Ø 16 mm

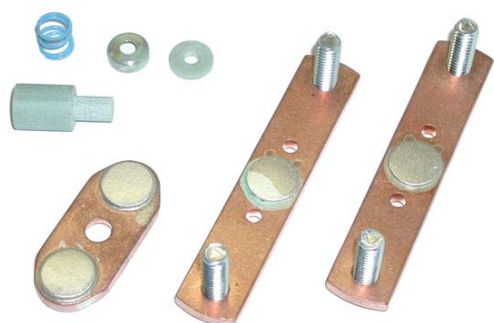

REF 133TA5759

Type: HB631
Tip size: Ø 19 mm

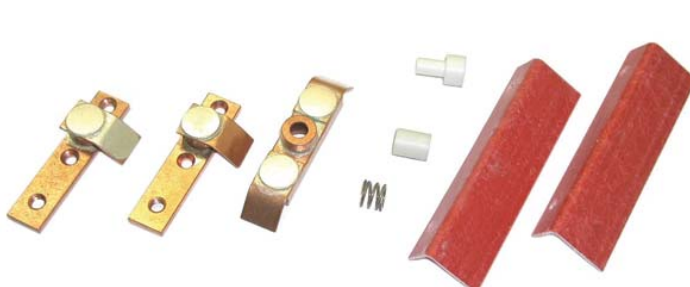

REF 133TA5251

PRESTOLITE

PRESTOLITE



CONTACT KITS

For all our latest catalogue updates and company info: www.tvh.com

used for: **PRESTOLITE**

Type: HB7
Tip size: Ø 12,7 mm



REF 133TA6306

Type: HB701
Tip size: Ø 12,7 mm

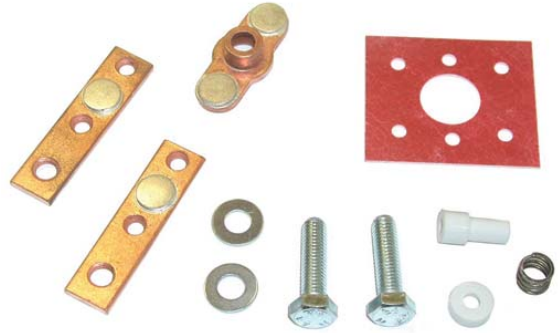

REF 108TA7699

Type: HB70JC
Tip size: Ø 12,7 mm

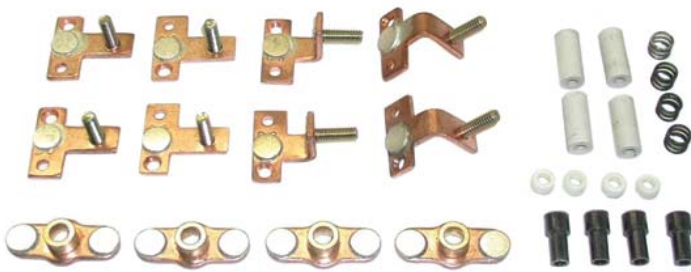

REF 133TA5037

Type: HB7KL/SL
Tip size: Ø 12,7 mm

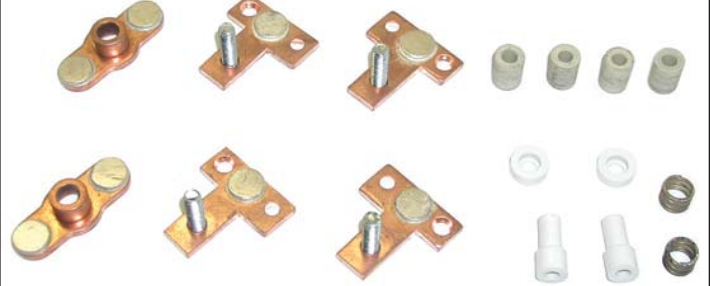

REF 133TA4197

Type: HBSP102
Tip size: Ø 9,5 mm

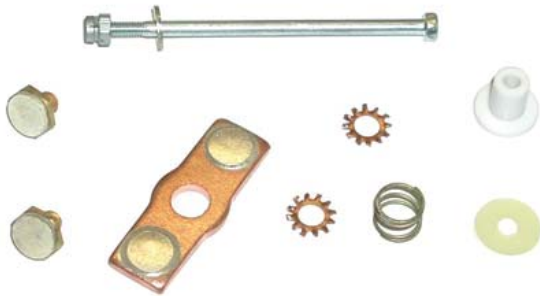

REF 133TA5308

Type: HBSP103
Tip size: Ø 9,5 mm



REF 133TA6793

Type: JAM
Tip size: Ø 9,5 mm

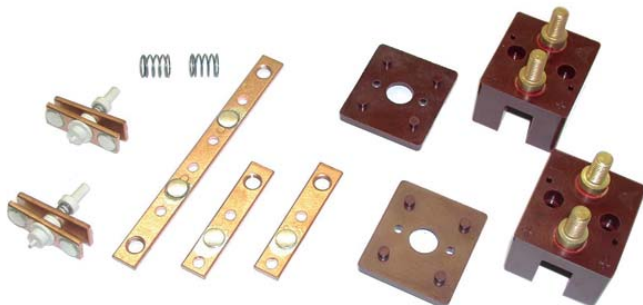

REF 133TA5414



PRESTOLITE

PRESTOLITE



TOTALSOURCE®

Look up
these parts via

PS ProductSearch

used for:
AMERICAN

AMERICAN

AMERICAN

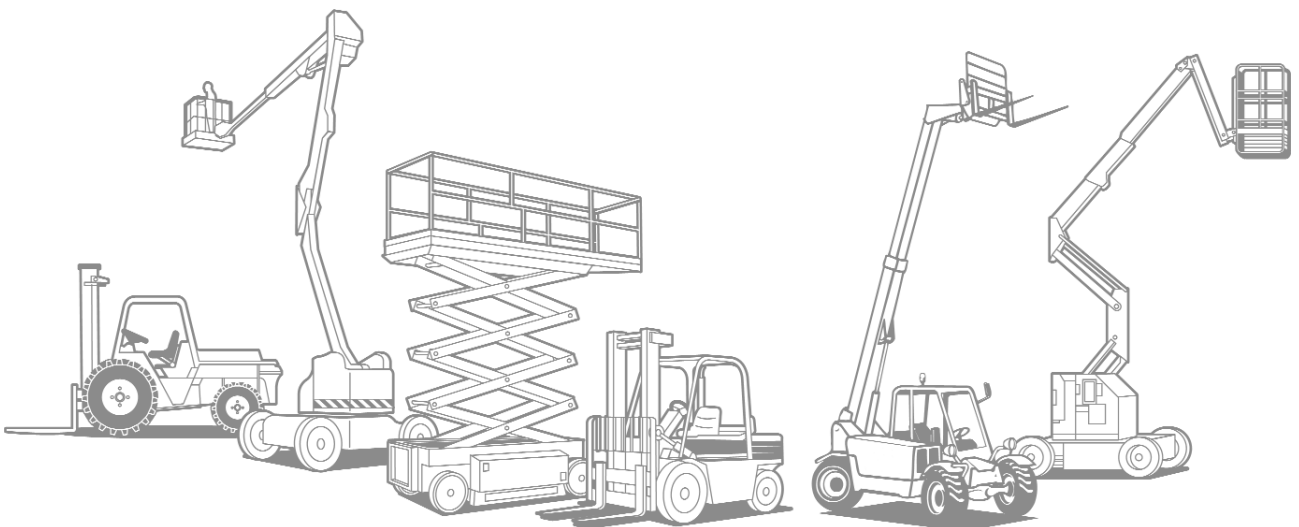



CONTACTS

For all our latest catalogue updates and company info: www.tvh.com

used for: **AMERICAN**

Type: ALLIS CHALMERS 100A

Tip size: Ø 15,9 mm
Length: 12,7 mm
Number of tips: 1



REF 138TA5828

Type: ALLIS CHALMERS 200A

Width: 25 mm
Length: 32 mm
Number of tips: 0



REF 138TA6311

Type: ALLIS CHALMERS 200A

Tip size: Ø 22,2 mm
Length: 18 mm
Number of tips: 1



REF 138TA5996

Type: CONTACT INDUSTRIES-300A

Tip size: Ø 16,6 mm
Width: 18 mm
Length: 95,2 mm
Number of tips: 1

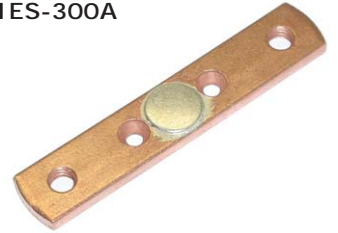

REF 138TA6065

Type: CONTACT INDUSTRIES-300A

Tip size: Ø 16,6 mm
Width: 37 mm
Length: 63,6 mm
Number of tips: 2



REF 138TA6066

Type: HYSTER

Tip size: Ø 16 mm
Width: 16 mm
Length: 88,6 mm
Number of tips: 1



REF 138TA6217

Type: HYSTER

Tip size: Ø 16 mm
Width: 19 mm
Length: 63,5 mm
Number of tips: 1



REF 138TA6216

Type: PETTIBONE

Width: 19,2 mm
Length: 25,3 mm
Number of tips: 0



REF 138TA6193

Type: PETTIBONE

Width: 24 mm
Length: 28 mm
Number of tips: 0



REF 138TA6194

Type: PETTIBONE

Tip size: 19,2 X 25,4 mm
Width: 25,7 mm
Length: 132,5 mm
Number of tips: 1



REF 138TA6200

Type: RAYMOND

Tip size: 16 X 19 mm
Width: 19 mm
Length: 38 mm
Number of tips: 1



REF 138TA6313

Type: RAYMOND

Tip size: Ø 11 mm
Width: 11,5 mm
Length: 17 mm
Number of tips: 1



REF 138TA6319

Type: RAYMOND

Tip size: Ø 11 mm
Width: 11,5 mm
Length: 51 mm
Number of tips: 2



REF 138TA6318

Type: RAYMOND

Tip size: Ø 12,7 mm
Length: 48 mm
Number of tips: 2



REF 138TA6281

AMERICAN

AMERICAN

CONTACTS



For all our latest catalogue updates and company info: www.tvh.com

used for: **AMERICAN**

Type: RAYMOND

Tip size: Ø 12,7 mm
Width: 12,6 mm
Length: 58,5 mm
Number of tips: 1



REF 109TA7745

Type: RAYMOND

Tip size: Ø 12,7 mm
Width: 12,6 mm
Length: 63 mm
Number of tips: 1



REF 122TA7617

Type: RAYMOND

Tip size: Ø 19 mm
Width: 19 mm
Length: 43 mm
Number of tips: 1



REF 138TA6286

Type: RAYMOND

Tip size: Ø 19 mm
Width: 19 mm
Length: 69,4 mm
Number of tips: 1



REF 138TA6278

Type: RAYMOND

Tip size: Ø 19 mm
Width: 19 mm
Length: 70 mm
Number of tips: 1



REF 122TA7624

Type: RAYMOND

Tip size: Ø 19 mm
Width: 21,5 mm
Length: 66,6 mm
Number of tips: 2



REF 138TA6287

Type: RAYMOND

Tip size: Ø 19 mm
Width: 25,4 mm
Length: 52 mm
Number of tips: 1



REF 122TA7632

Type: RAYMOND

Tip size: Ø 19 mm
Width: 44,5 mm
Length: 60,5 mm
Number of tips: 1

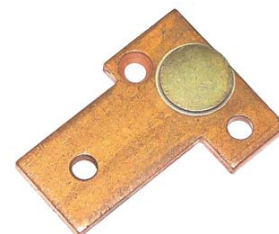

REF 138TA6288

Type: SQUARE D

Tip size: 11 X 12,7 mm
Width: 12,7 mm
Length: 34,6 mm
Number of tips: 1



REF 110TA2501

Type: SQUARE D

Tip size: Ø 12,7 mm
Width: 16 mm
Length: 47 mm
Number of tips: 2



REF 122TA7660

Type: SQUARE D

Tip size: Ø 12,7 mm
Width: 16,2 mm
Length: 47 mm
Number of tips: 1



REF 138TA6293

Type: SQUARE D

Tip size: Ø 13,3 mm
Width: 19,3 mm
Length: 80,5 mm
Number of tips: 1



REF 138TA6236

Type: SQUARE D

Tip size: Ø 15,9 mm
Width: 15,9 mm
Length: 37,8 mm
Number of tips: 2



REF 138TA5887

Type: SQUARE D

Tip size: Ø 15,9 mm
Width: 16 mm
Length: 30,4 mm
Number of tips: 1



REF 134TA2283

AMERICAN

AMERICAN



CONTACTS

For all our latest catalogue updates and company info: www.tvh.com

used for: **AMERICAN**

Type: SQUARE D

Tip size: Ø 15,9 mm
Width: 16 mm
Length: 37,8 mm
Number of tips: 1



REF 109TA8571

Type: SQUARE D

Tip size: Ø 15,9 mm
Width: 16 mm
Length: 52 mm
Number of tips: 1



REF 138TA5930

Type: SQUARE D

Tip size: Ø 15,9 mm
Width: 16 mm
Length: 56 mm
Number of tips: 1



REF 138TA5877

Type: SQUARE D

Tip size: Ø 15,9 mm
Width: 19 mm
Length: 43 mm
Number of tips: 1



REF 138TA5904

Type: SQUARE D

Tip size: Ø 15,9 mm
Width: 19 mm
Length: 56,3 mm
Number of tips: 1



REF 138TA5920

Type: SQUARE D

Tip size: Ø 15,9 mm
Width: 19 mm
Length: 57,5 mm
Number of tips: 1



REF 110TA2444

Type: SQUARE D

Tip size: Ø 15,9 mm
Width: 19 mm
Length: 63,5 mm
Number of tips: 1



REF 138TA6196

Type: SQUARE D

Tip size: Ø 15,9 mm
Width: 19 mm
Length: 64,5 mm
Number of tips: 1



REF 138TA6195

Type: SQUARE D

Tip size: Ø 15,9 mm
Width: 19 mm
Length: 78 mm
Number of tips: 1



REF 138TA5907

Type: SQUARE D

Tip size: Ø 15,9 mm
Width: 19 mm
Length: 78 mm
Number of tips: 2



REF 110TA9040

Type: SQUARE D

Tip size: Ø 15,9 mm
Width: 19 mm
Length: 80 mm
Number of tips: 2

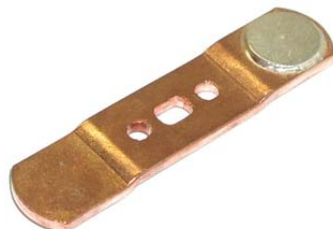

REF 138TA6181

Type: SQUARE D

Tip size: Ø 15,9 mm
Width: 19 mm
Length: 92 mm
Number of tips: 2

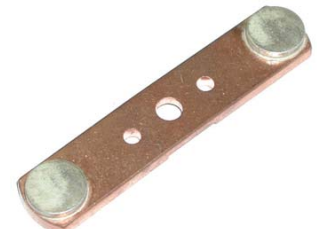

REF 108TA5356

Type: SQUARE D

Tip size: Ø 15,9 mm
Width: 19 mm
Length: 94 mm
Number of tips: 2



REF 138TA5944

Type: SQUARE D

Tip size: Ø 15,9 mm
Width: 19,4 mm
Length: 22 mm
Number of tips: 1



REF 138TA5906

AMERICAN

AMERICAN

CONTACTS



For all our latest catalogue updates and company info: www.tvh.com

used for: **AMERICAN**

Type: **SQUARE D**

Tip size: Ø 15,9 mm
Width: 20,6 mm
Length: 37 mm
Number of tips: 1



REF 110TA2672

Type: **SQUARE D**

Tip size: Ø 22,3 mm
Length: 15,2 mm
Number of tips: 1



REF 138TA5843

Type: **SQUARE D**

Tip size: Ø 28,6 mm
Length: 15 mm
Number of tips: 1



REF 138TA6296

Type: **YALE**

Tip size: Ø 22,3 mm
Width: 25,5 mm
Length: 39,7 mm
Number of tips: 1



REF 138TA6233

AMERICAN

AMERICAN

Look up
these parts via

PS ProductSearch

CONTACT KITS

For all our latest catalogue updates and company info: www.tvh.com

used for: **AMERICAN**

Type: ALLIS CHALMERS 100A
Tip size: \varnothing 15,9 mm



REF 133TA4951

Type: ALLIS CHALMERS 200A
Tip size: \varnothing 22,2 mm



REF 133TA3326

Type: CLARK
Tip size: \varnothing 9,5 mm

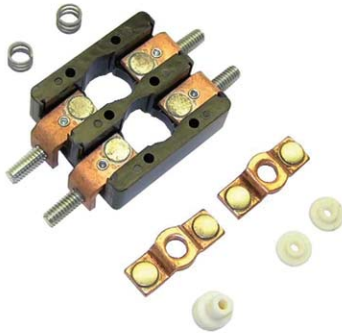

REF 133TA7617

Type: CONTACT INDUSTRIES 300A
Tip size: \varnothing 16,6 mm

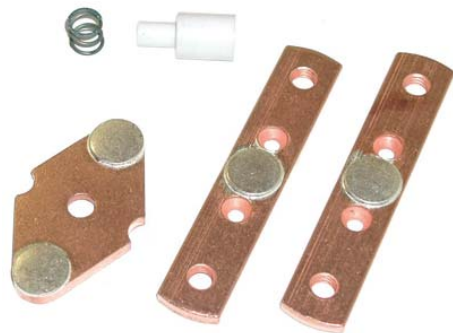

REF 133TA5692

Type: CROWN
Tip size: \varnothing 19 mm

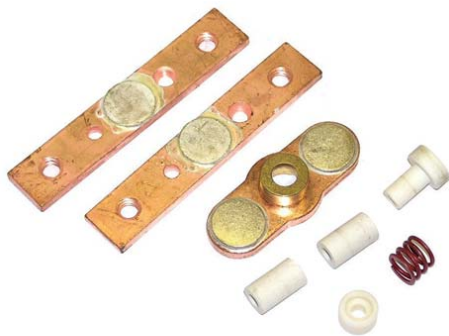

REF 122TA7667

Type: RAYMOND
Tip size: 9,5 X 9,5 mm

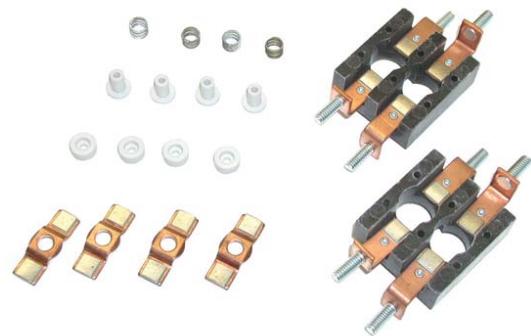

REF 133TA6567

Type: RAYMOND
Tip size: 9,5 X 9,5 mm



REF 133TA6544

Type: RAYMOND
Tip size: \varnothing 9,5 mm



REF 133TA7338

AMERICAN

AMERICAN

CONTACT KITS



For all our latest catalogue updates and company info: www.tvh.com

used for: **AMERICAN**

Type: RAYMOND
Tip size: \varnothing 9,5 mm

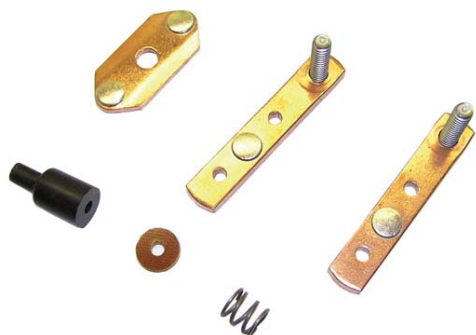

REF 133TA7584

Type: RAYMOND
Tip size: \varnothing 9,7 mm

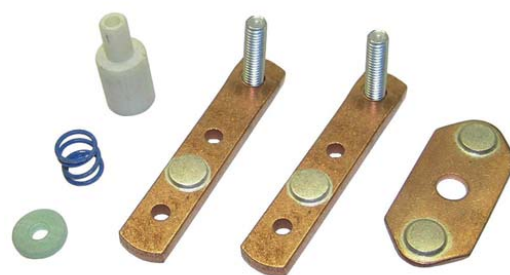

REF 133TA7717

Type: RAYMOND
Tip size: \varnothing 10,4 mm



REF 133TA4308

Type: RAYMOND
Tip size: \varnothing 12,7 mm



REF 133TA3373

Type: RAYMOND
Tip size: \varnothing 12,7 mm



REF 133TA4321

Type: RAYMOND
Tip size: \varnothing 12,7 mm

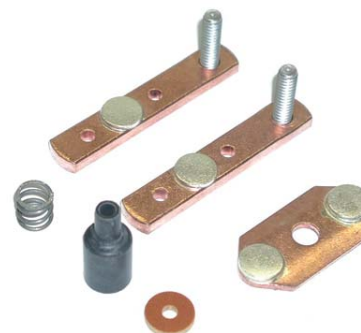

REF 133TA7358

Type: RAYMOND
Tip size: \varnothing 12,7 mm

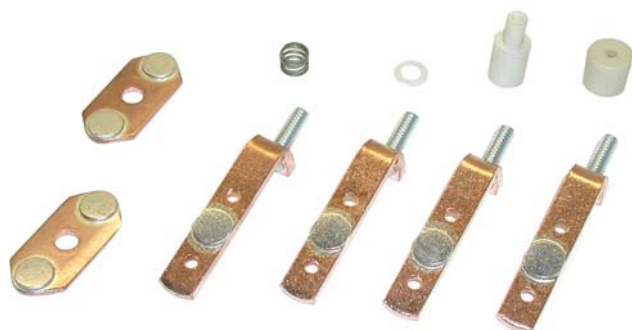

REF 133TA7288

Type: RAYMOND
Tip size: \varnothing 16 mm

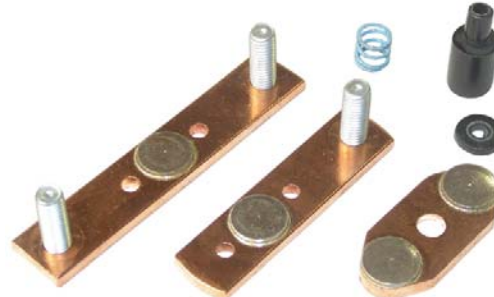

REF 138TA6532

AMERICAN

AMERICAN

CONTACT KITS

For all our latest catalogue updates and company info: www.tvh.com

used for: **AMERICAN**

Type: RAYMOND
Tip size: Ø 19 mm

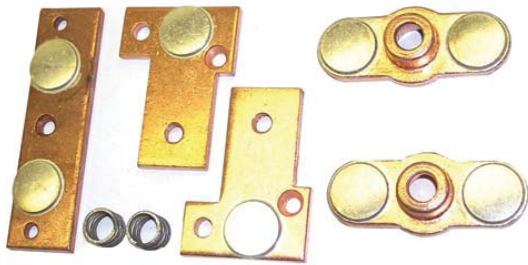

REF 133TA7575

Type: RAYMOND
Tip size: Ø 19 mm



REF 133TA5463

Type: SQUARE D
Tip size: Ø 15,9 mm



REF 133TA6582

Type: SQUARE D
Tip size: Ø 15,9 mm



REF 133TA6490

Type: SQUARE D
Tip size: Ø 15,9 mm



REF 133TA6663

Type: SQUARE D
Tip size: Ø 15,9 mm



REF 108TA8115

Type: SQUARE D
Tip size: Ø 22,3 mm



REF 133TA4036

Type: SQUARE D
Tip size: Ø 28,6 mm



REF 133TA6463

AMERICAN

AMERICAN



TOTALSOURCE®

Look up
these parts via

PS ProductSearch

used for:
SPECIAL FRENCH

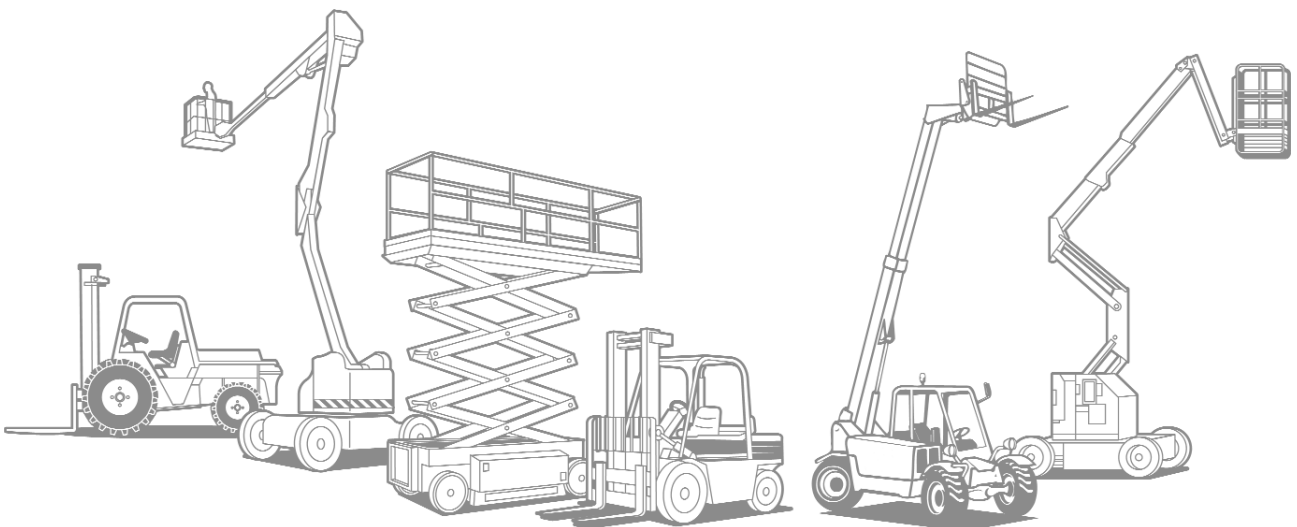

SPECIAL FRENCH

SPECIAL FRENCH



CONTACTS

For all our latest catalogue updates and company info: www.tvh.com

used for: **SPECIAL FRENCH**

Type: AMELEC

Tip size: 10,5 X 12,5 mm
Width: 14 mm
Length: 64 mm
Number of tips: 2



REF 108TA7360

Type: AMELEC

Tip size: 9,5 X 11,9 mm
Width: 15 mm
Length: 25,3 mm
Number of tips: 1



REF 138TA5903

Type: AMELEC

Tip size: 10,3 X 20 mm
Width: 15 mm
Length: 70 mm
Number of tips: 2



REF 138TA5901

Type: AMELEC

Tip size: 10 X 10 mm
Width: 16 mm
Length: 40 mm
Number of tips: 1



REF 110TA1865

Type: AMELEC

Tip size: 9,6 X 12 mm
Width: 20 mm
Length: 77 mm
Number of tips: 1



REF 138TA6135

Type: AMELEC

Tip size: 10 X 20 mm
Width: 25 mm
Length: 75 mm
Number of tips: 1



REF 138TA5870

Type: AMELEC

Tip size: 11 X 19 mm
Width: 40 mm
Length: 56,2 mm
Number of tips: 1



REF 138TA5900

Type: AMELEC

Tip size: 10 X 20 mm
Width: 40 mm
Length: 70 mm
Number of tips: 1



REF 138TA5943

Type: AMELEC - DP

Tip size: Ø 10,2 mm
Width: 20 mm
Length: 75 mm
Number of tips: 1



REF 134TA2285

Type: AMELEC-1

Tip size: 25,2 X 50 mm
Width: 25,2 mm
Length: 50 mm
Number of tips: 1



REF 138TA5977

Type: AMELEC-1

Tip size: 10 X 53 mm
Width: 66 mm
Length: 43 mm
Number of tips: 1



REF 138TA5978

Type: AMELEC-Ag

Tip size: 10,2 X 20 mm
Width: 20 mm
Length: 38,2 mm
Number of tips: 1



REF 138TA6241

Type: AMELEC-Ag

Tip size: 10 X 20 mm
Width: 25 mm
Length: 75,4 mm
Number of tips: 1



REF 138TA5818

Type: AMELEC-Cu

Tip size: 10,3 X 18,2 mm
Width: 20,2 mm
Length: 37,6 mm
Number of tips: 1



REF 108TA5733

SPECIAL FRENCH

SPECIAL FRENCH



For all our latest catalogue updates and company info: www.tvh.com

used for: **SPECIAL FRENCH**

Type: AMELEC-W+Ag

Tip size: 10 X 20 mm
Width: 25 mm
Length: 75 mm
Number of tips: 1



REF 138TA5871

Type: FENWICK

Tip size: 11,7 X 11,7 mm
Width: 14 mm
Length: 25 mm
Number of tips: 1



REF 132TA2549

Type: FENWICK

Width: 20 mm
Length: 22 mm
Number of tips: 0



REF 132TA2511

Type: FENWICK

Tip size: 23,7 X 23,7 mm
Width: 24 mm
Length: 24,5 mm
Number of tips: 1

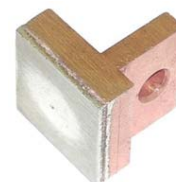

REF 138TA5858

Type: FENWICK

Tip size: 25 X 25,6 mm
Width: 25 mm
Length: 25,6 mm
Number of tips: 1



REF 108TA7416

Type: TELEMECANIQUE

Width: 24 mm
Length: 32,2 mm
Number of tips: 0



REF 138TA6242

Type: TELEMECANIQUE-CC3HB

Tip size: Ø 13 mm
Width: 18 mm
Length: 63,5 mm
Number of tips: 2

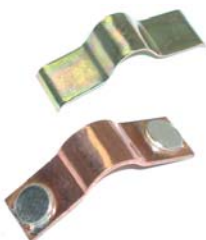

REF 138TA6125

Type: TELEMECANIQUE-CC3HB

Tip size: Ø 13 mm
Width: 19,2 mm
Length: 63 mm
Number of tips: 1



REF 138TA6123

SPECIAL FRENCH

SPECIAL FRENCH

Look up
these parts via

PS ProductSearch



CONTACT KITS

For all our latest catalogue updates and company info: www.tvh.com

used for: **SPECIAL FRENCH**

Type: AMELEC
Tip size: 10 X 20 mm



REF 132TA3292

Type: AMELEC
Tip size: Ø 10,2 mm



REF 132TA3147

Type: AMELEC - 2-CO
Tip size: 10 X 12 mm



REF 108TA7669

Type: AMELEC - 2-NO
Tip size: 10 X 12 mm



REF 108TA7674

Type: AMELEC - DP
Tip size: 10,5 X 12,5 mm

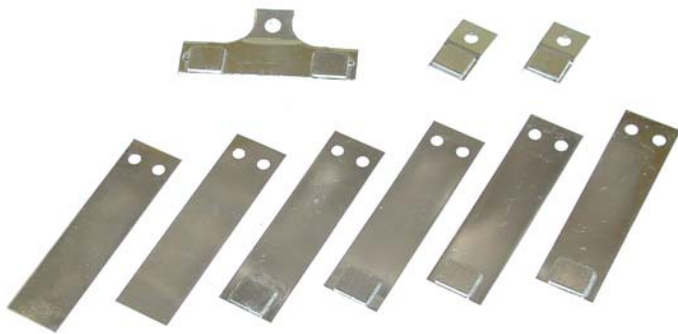

REF 108TA7662

Type: AMELEC - DP
Tip size: Ø 10 mm

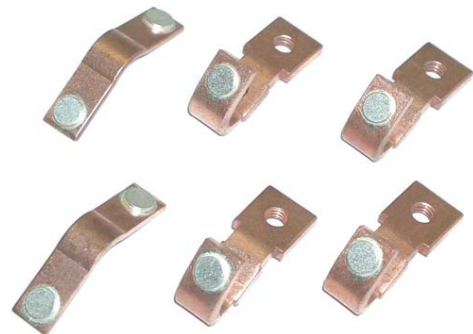

REF 132TA3211

Type: AMELEC - NO
Tip size: 11,5 X 11,5 mm



REF 138TA6510

Type: TELEMECANIQUE
Tip size: Ø 10,5 mm



REF 133TA7319

SPECIAL FRENCH

SPECIAL FRENCH



For all our latest catalogue updates and company info: www.tvh.com

used for: **SPECIAL FRENCH**

Type: **TELEMECANIQUE - CC3FB**
Tip size: \varnothing 10 mm



REF 133TA6979

Type: **TELEMECANIQUE - CC3HB**
Tip size: \varnothing 13 mm

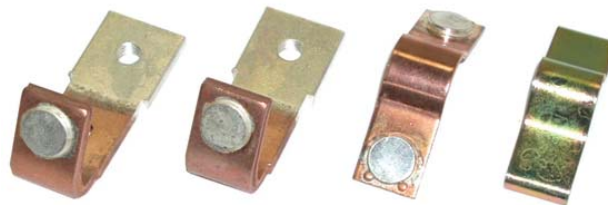

REF 133TA6950

SPECIAL FRENCH

SPECIAL FRENCH

Look up
these parts via

PS ProductSearch



TOTALSOURCE®

Look up
these parts via

PS ProductSearch

used for:
SPECIAL GERMAN

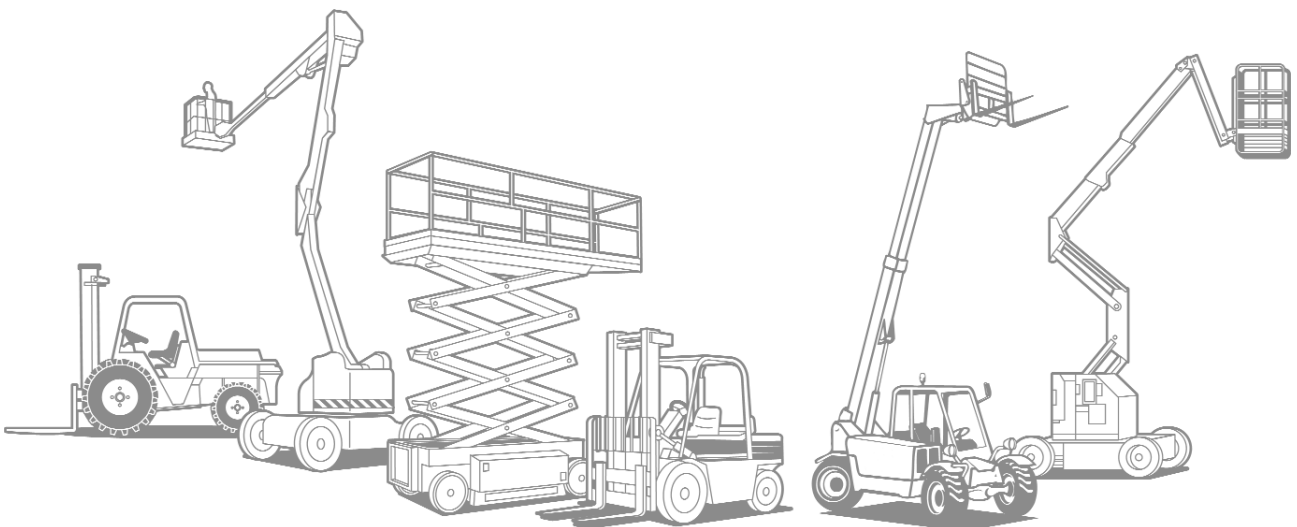

SPECIAL GERMAN

SPECIAL GERMAN



CONTACTS

For all our latest catalogue updates and company info: www.tvh.com

used for: **SPECIAL GERMAN**

Type:

Tip size: 16 X 18 mm
Width: 18 mm
Length: 78 mm
Number of tips: 1



REF 110TA2529

Type:

Tip size: Ø 8,2 mm
Width: 10,7 mm
Length: 26,8 mm
Number of tips: 2



REF 110TA2740

Type: BOSCH

Tip size: Ø 10 mm
Length: 27 mm
Number of tips: 1



REF 138TA5964

Type: BOSCH

Tip size: Ø 15,1 mm
Width: 16,1 mm
Length: 117,5 mm
Number of tips: 1



REF 138TA6321

Type: BOSCH 03331032004

Tip size: Ø 8 mm
Width: 12 mm
Length: 41 mm
Number of tips: 1



REF 138TA6298

Type: BOSCH-0333006004

Tip size: Ø 10,8 mm
Width: 20,2 mm
Length: 156 mm
Number of tips: 2



REF 138TA5957

Type: BOSCH-0333006004

Tip size: Ø 11 mm
Width: 20 mm
Length: 40,5 mm
Number of tips: 1



REF 138TA5970

Type: BOSCH-0333007002

Tip size: 7,5 X 29,6 mm
Width: 13 mm
Length: 60,3 mm
Number of tips: 1



REF 138TA6140

Type: BOSCH-0333007002

Width: 14,2 mm
Length: 70,6 mm
Number of tips: 0



REF 138TA6197

Type: BOSCH-0333007002

Tip size: 5,5 X 26,5 mm
Width: 40 mm
Length: 46 mm
Number of tips: 2

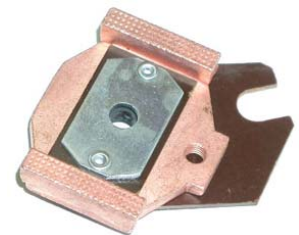

REF 138TA6139

Type: BOSCH-0333007004

Tip size: Ø 8 mm
Width: 13,2 mm
Length: 32,4 mm
Number of tips: 4



REF 138TA5880

Type: BOSCH-0333007004

Tip size: Ø 9 mm
Width: 10 mm
Length: 41,2 mm
Number of tips: 1



REF 138TA5922

Type: BOSCH-0333007004

Tip size: Ø 9 mm
Width: 13 mm
Length: 32,8 mm
Number of tips: 2



REF 138TA5953

Type: BOSCH-033320

Tip size: Ø 15 mm
Width: 16 mm
Length: 50,5 mm
Number of tips: 1



REF 138TA6185

SPECIAL GERMAN

SPECIAL GERMAN

CONTACTS



For all our latest catalogue updates and company info: www.tvh.com

used for: **SPECIAL GERMAN**

Type: **BOSCH-0333200**

Tip size: Ø 15 mm
Width: 16 mm
Length: 68,5 mm
Number of tips: 1



REF 138TA5878

Type: **BOSCH-0333200**

Tip size: Ø 15 mm
Width: 16 mm
Length: 69 mm
Number of tips: 1



REF 138TA5956

Type: **BOSCH-0333201**

Tip size: Ø 10 mm
Length: 38 mm
Number of tips: 1



REF 138TA5834

Type: **BOSCH-0333201**

Tip size: Ø 15 mm
Width: 16 mm
Length: 69,5 mm
Number of tips: 2



REF 138TA5827

Type: **BOSCH-201**

Tip size: Ø 15 mm
Width: 16 mm
Length: 69,5 mm
Number of tips: 2



REF 138TA6271

Type: **JUNGHEINRICH**

Tip size: 14,8 X 20 mm
Width: 15,2 mm
Length: 20,5 mm
Number of tips: 1



REF 138TA6239

Type: **JUNGHEINRICH**

Tip size: Ø 18,8 mm
Width: 19 mm
Length: 40 mm
Number of tips: 1



REF 138TA5872

Type: **JUNGHEINRICH**

Tip size: Ø 18,8 mm
Width: 19,3 mm
Length: 40,5 mm
Number of tips: 1



REF 138TA6243

Type: **JUNGHEINRICH**

Tip size: Ø 18,9 mm
Width: 19 mm
Length: 133 mm
Number of tips: 6



REF 138TA6069

Type: **JUNGHEINRICH**

Tip size: Ø 19 mm
Length: 25,5 mm
Number of tips: 1



REF 138TA6244

Type: **JUNGHEINRICH**

Tip size: Ø 19 mm
Width: 19 mm
Length: 65 mm
Number of tips: 1



REF 138TA6204

Type: **JUNGHEINRICH**

Tip size: Ø 19 mm
Width: 19 mm
Length: 65 mm
Number of tips: 1



REF 138TA6068

Type: **JUNGHEINRICH**

Tip size: Ø 19 mm
Width: 19,2 mm
Length: 40 mm
Number of tips: 1



REF 138TA5971

Type: **SCHALTBAU**

Tip size: Ø 9 mm
Width: 20,5 mm
Length: 38,3 mm
Number of tips: 2



REF 110TA2692

SPECIAL GERMAN

SPECIAL GERMAN



CONTACTS

For all our latest catalogue updates and company info: www.tvh.com

used for: **SPECIAL GERMAN**

Type: SCHALTBAU-S137

Tip size: \varnothing 6,3 mm
Width: 8 mm
Length: 33 mm
Number of tips: 1



REF 138TA5916

Type: SCHALTBAU-S137-CO

Tip size: 4 X 8 mm
Width: 8 mm
Length: 28,3 mm
Number of tips: 1



REF 138TA5947

Type: SCHALTBAU-S137-CO

Tip size: 5 X 8 mm
Width: 8,1 mm
Length: 38 mm
Number of tips: 1



REF 108TA5359

Type: SCHALTBAU-S137-CO

Tip size: \varnothing 6 mm
Width: 13,4 mm
Length: 28 mm
Number of tips: 4



REF 138TA6253

Type: SCHALTBAU-S137-NO

Tip size: \varnothing 6 mm
Width: 13,4 mm
Length: 28 mm
Number of tips: 2



REF 138TA5931

Type: SCHALTBAU-S163

Tip size: \varnothing 8 mm
Width: 10 mm
Length: 45 mm
Number of tips: 1



REF 108TA5847

Type: SCHALTBAU-S163-CO

Tip size: 5,5 X 8,8 mm
Length: 45,5 mm
Number of tips: 1



REF 108TA7285

Type: SCHALTBAU-S163-CO

Tip size: 6 X 9 mm
Width: 9 mm
Length: 37,5 mm
Number of tips: 1



REF 138TA6290

Type: SCHALTBAU-S163-CO

Tip size: \varnothing 8 mm
Width: 23 mm
Length: 33 mm
Number of tips: 4



REF 138TA6289

Type: SCHALTBAU-S163-NO

Tip size: \varnothing 8 mm
Width: 21 mm
Length: 33 mm
Number of tips: 2



REF 108TA7178

Type: SCHALTBAU-S164

Tip size: \varnothing 9 mm
Width: 10,2 mm
Length: 45 mm
Number of tips: 1

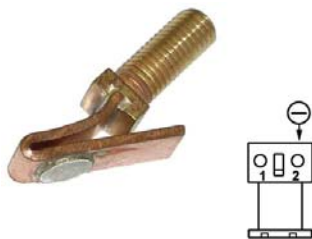

REF 138TA5911

Type: SCHALTBAU-S164

Tip size: \varnothing 9 mm
Width: 10,5 mm
Length: 44,7 mm
Number of tips: 1



REF 138TA5918

Type: SCHALTBAU-S164-CO

Tip size: 6,6 X 10,1 mm
Width: 10,1 mm
Length: 33 mm
Number of tips: 1



REF 138TA5948

Type: SCHALTBAU-S164-CO

Tip size: 7 X 10 mm
Width: 10,2 mm
Length: 41,7 mm
Number of tips: 1



REF 108TA5835

SPECIAL GERMAN

SPECIAL GERMAN



used for: SPECIAL GERMAN

Type: SCHALTBAU-S164-CO

Tip size: Ø 9 mm
Width: 20,4 mm
Length: 38 mm
Number of tips: 4



REF 138TA5979

Type: SCHALTBAU-S164-NO

Tip size: Ø 9 mm
Width: 21 mm
Length: 38 mm
Number of tips: 2



REF 138TA5881

Type: SCHALTBAU-S165

Tip size: Ø 11,3 mm
Width: 15,1 mm
Length: 60 mm
Number of tips: 1

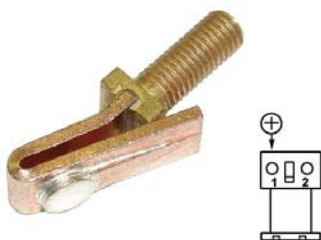

REF 138TA5927

Type: SCHALTBAU-S165-NO

Tip size: Ø 11,3 mm
Width: 15,2 mm
Length: 60 mm
Number of tips: 1

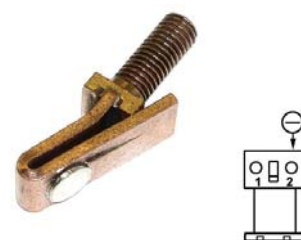

REF 108TA5966

Type: SCHALTBAU-S165-NO

Tip size: Ø 11,3 mm
Width: 53,5 mm
Length: 36 mm
Number of tips: 2



REF 138TA5894

Type: SCHALTBAU-S167A

Tip size: Ø 12 mm
Width: 14 mm
Length: 26,6 mm
Number of tips: 1



REF 138TA6072

Type: SCHALTBAU-S971A

Tip size: Ø 8,8 mm
Length: 29 mm
Number of tips: 1



REF 138TA6071

Type: SCHALTBAU-S971A

Tip size: Ø 8,8 mm
Length: 29 mm
Number of tips: 4



REF 108TA7076

Type: SCHALTBAU-S971A

Tip size: Ø 8,8 mm
Width: 23,3 mm
Length: 47,4 mm
Number of tips: 2



REF 138TA6070

Type: STEINBOCK

Tip size: 15 X 20 mm
Width: 20 mm
Length: 29 mm
Number of tips: 1



REF 138TA5867

Type: STEINBOCK

Tip size: 15 X 20 mm
Width: 20 mm
Length: 38 mm
Number of tips: 1



REF 138TA5869

Type: STILL

Width: 12 mm
Length: 31,6 mm
Number of tips: 0



REF 132TA2463

Type: STILL

Tip size: 20 X 30 mm
Width: 20 mm
Length: 30 mm
Number of tips: 1

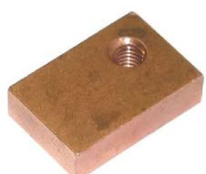

REF 138TA6178

Type: STILL

Width: 20 mm
Length: 53,5 mm
Number of tips: 0



REF 132TA2526



CONTACTS

For all our latest catalogue updates and company info: www.tvh.com

used for: **SPECIAL GERMAN**

Type: STILL

Tip size: Ø 11,9 mm

Length: 11,9 mm

Number of tips: 1



REF 138TA5838

Type: STILL

Tip size: Ø 13 mm

Length: 12 mm

Number of tips: 1



REF 138TA6274

Type: STILL

Tip size: Ø 20 mm

Length: 12 mm

Number of tips: 1



REF 138TA6176

Type: STILL

Tip size: Ø 20 mm

Width: 18 mm

Length: 56 mm

Number of tips: 1



REF 108TA7450

Type: STILL/ LINDE

Tip size: 9,9 X 15,3 mm

Width: 16 mm

Length: 28 mm

Number of tips: 1



REF 138TA6238

Type: STILL/ LINDE

Width: 16 mm

Length: 29 mm

Number of tips: 1



REF 138TA6240

SPECIAL GERMAN

SPECIAL GERMAN



CONTACT KITS



For all our latest catalogue updates and company info: www.tvh.com

used for: **SPECIAL GERMAN**

Type:
Tip size: Ø 6 mm

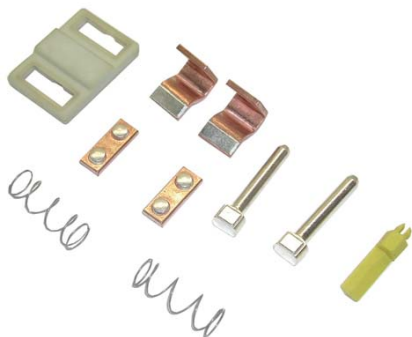

REF 133TA7521

Type: BOSCH - 0333007002

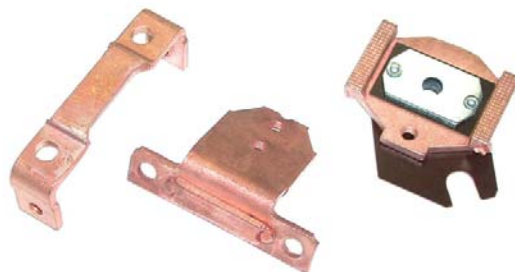

REF 111TA6167

Type: BOSCH - 0333007004
Tip size: Ø 9 mm



REF 111TA6169

Type: BOSCH - 0333200
Tip size: Ø 15 mm



REF 110TA3561

Type: BOSCH - 0333201
Tip size: Ø 15 mm

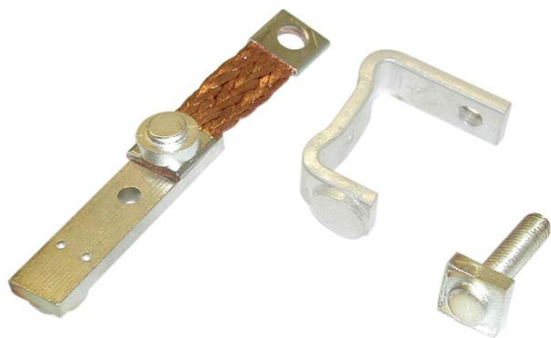

REF 111TA6191

Type: SCHALTBAU-S137-CO
Tip size: Ø 6 mm



REF 133TA5898

Type: SCHALTBAU-S137-NO
Tip size: Ø 6 mm

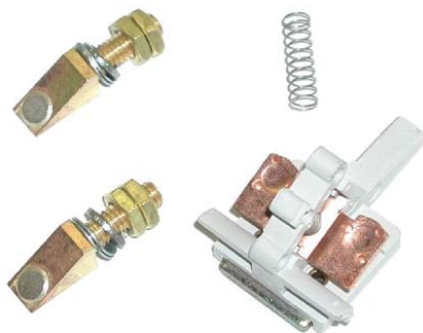

REF 133TA4418

Type: SCHALTBAU-S137-NO + COVER
Tip size: Ø 6 mm

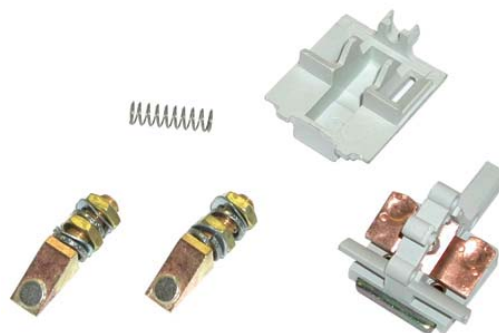

REF 133TA6036

SPECIAL GERMAN

SPECIAL GERMAN

CONTACT KITS

For all our latest catalogue updates and company info: www.tvh.com

used for: **SPECIAL GERMAN**

Type: SCHALTBAU-S163-CO
Tip size: Ø 8 mm

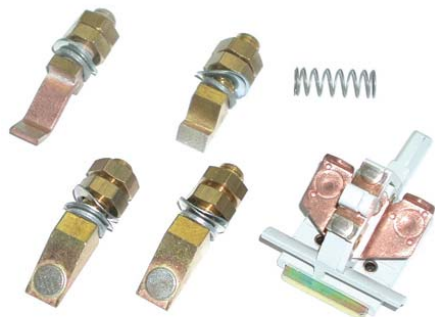

REF 133TA6078

Type: SCHALTBAU-S163-NO
Tip size: Ø 8 mm

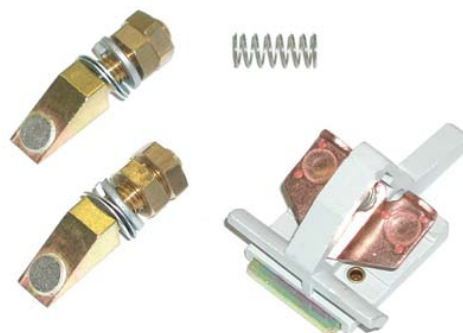

REF 133TA4065

Type: SCHALTBAU-S164-CO
Tip size: Ø 9 mm



REF 138TA6516

Type: SCHALTBAU-S164-CO + COVER
Tip size: Ø 9 mm

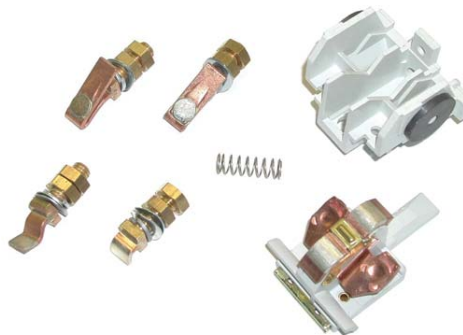

REF 133TA3546

Type: SCHALTBAU-S164-NO
Tip size: Ø 9 mm

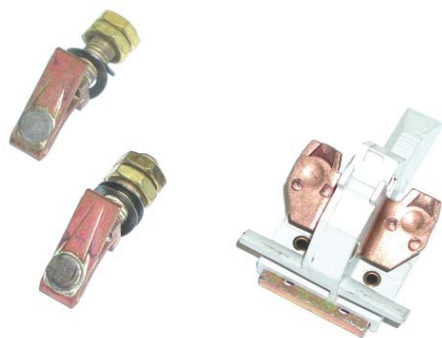

REF 133TA4609

Type: SCHALTBAU-S165-CO
Tip size: Ø 11,3 mm

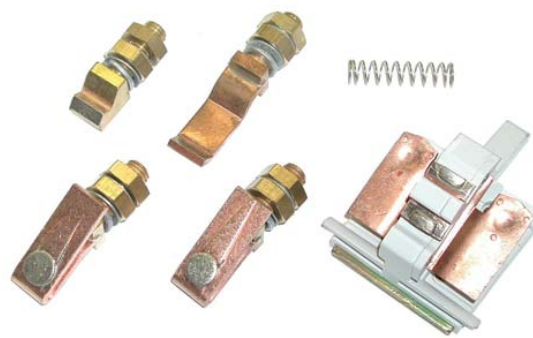

REF 133TA6150

Type: SCHALTBAU-S165-NO
Tip size: Ø 11,3 mm

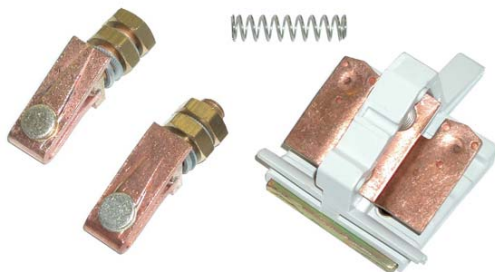

REF 138TA6519

Type: SCHALTBAU-S167A
Tip size: Ø 12 mm



REF 107TA1526

SPECIAL GERMAN

SPECIAL GERMAN



For all our latest catalogue updates and company info: www.tvh.com

used for: **SPECIAL GERMAN**

Type: SCHALTBAU-S187A10
Width: 80 X 80 mm



REF 118TA4298

Type: SCHALTBAU-S187A17
Width: 80 X 80 mm



REF 138TA6521

Type: SCHALTBAU-S187A28/29
Width: 80 X 80 mm



REF 133TA7385

Type: SCHALTBAU-S195S
Tip size: 10 X 11,5 mm



REF 133TA6451

Type: SCHALTBAU-S195W
Tip size: Ø 8 mm



REF 133TA6330

Type: SCHALTBAU-S306-200A
Width: 27 mm



REF 133TA7397

Type: SCHALTBAU-S306M-160A
Width: 27 mm



REF 133TA7411

Type: SCHALTBAU-S307-250A
Width: 31 mm



REF 133TA7435

SPECIAL GERMAN

SPECIAL GERMAN



used for: **SPECIAL GERMAN**

Type: **STILL**

Tip size: \varnothing 13 mm



REF 108TA7710

Look up
these parts via

PS ProductSearch



TOTALSOURCE®

Look up
these parts via

PS ProductSearch

used for:
JAPANESE

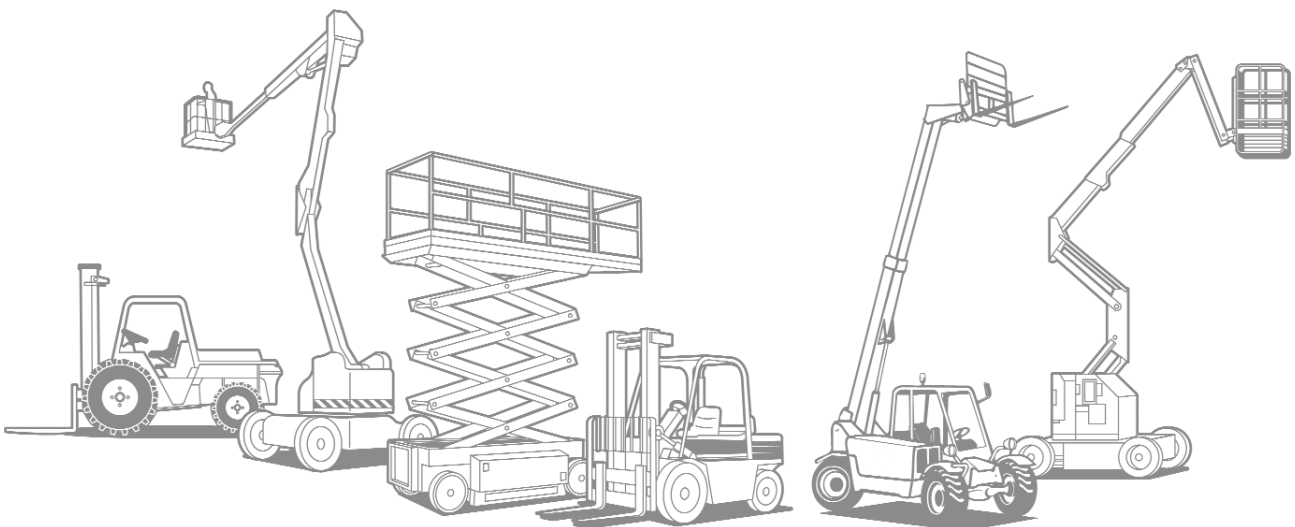



CONTACTS

For all our latest catalogue updates and company info: www.tvh.com

used for: **JAPANESE**

Type:

Tip size: Ø 8 mm
Width: 22 mm
Length: 50 mm
Number of tips: 2



REF 138TA6391

Type: DENSO

Tip size: 12,5 X 12,5 mm
Width: 18 mm
Length: 59 mm
Number of tips: 1



REF 138TA6134

Type: DENSO

Tip size: 15,7 X 15,7 mm
Width: 18 mm
Length: 97 mm
Number of tips: 1



REF 138TA6110

Type: DENSO

Tip size: 15,5 X 15,5 mm
Width: 18 mm
Length: 97,3 mm
Number of tips: 2



REF 108TA6952

Type: DENSO

Tip size: Ø 10 mm
Width: 15 mm
Length: 48 mm
Number of tips: 4



REF 138TA6103

Type: DENSO

Tip size: Ø 10 mm
Width: 15 mm
Length: 63,7 mm
Number of tips: 1



REF 138TA6073

Type: DENSO

Tip size: Ø 10 mm
Width: 15 mm
Length: 64,3 mm
Number of tips: 1



REF 138TA6162

Type: DENSO

Tip size: Ø 10 mm
Width: 15,2 mm
Length: 48 mm
Number of tips: 2



REF 138TA6085

Type: DENSO

Tip size: Ø 13 mm
Width: 15 mm
Length: 49 mm
Number of tips: 2



REF 108TA7021

Type: DENSO

Tip size: Ø 13 mm
Width: 15 mm
Length: 64,5 mm
Number of tips: 1



REF 138TA6127

Type: DENSO

Tip size: Ø 13 mm
Width: 15 mm
Length: 64,5 mm
Number of tips: 1



REF 138TA6128

Type: DENSO

Tip size: Ø 15 mm
Length: 18 mm
Number of tips: 1



REF 138TA6119

Type: DENSO

Tip size: Ø 15 mm
Width: 20 mm
Length: 42,5 mm
Number of tips: 1



REF 138TA6215

Type: DENSO

Tip size: Ø 16 mm
Length: 19 mm
Number of tips: 1



REF 138TA6120

JAPANESE

JAPANESE



used for: JAPANESE

Type: DENSO-3

Tip size: 13,4 X 13,4 mm
Width: 18 mm
Length: 66,3 mm
Number of tips: 1



REF 138TA6101

Type: DENSO-4

Tip size: 13 X 14 mm
Width: 17,8 mm
Length: 66 mm
Number of tips: 1



REF 138TA6086

Type: DENSO-4

Tip size: 15 X 15 mm
Width: 18 mm
Length: 50 mm
Number of tips: 1



REF 138TA6090

Type: DENSO-4

Tip size: 13,5 X 13,5 mm
Width: 18 mm
Length: 97 mm
Number of tips: 1



REF 138TA6087

Type: HITACHI

Tip size: Ø 12,2 mm
Width: 16 mm
Length: 52,2 mm
Number of tips: 2



REF 108TA5823

Type: HITACHI MS4252

Tip size: Ø 7,3 mm
Width: 13,8 mm
Length: 32,7 mm
Number of tips: 1



REF 108TA5740

Type: HITACHI MS4252

Tip size: Ø 7,3 mm
Width: 16 mm
Length: 87,3 mm
Number of tips: 1

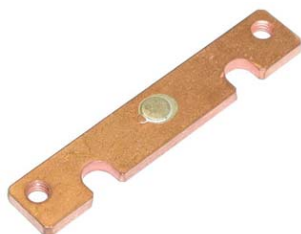

REF 108TA5520

Type: HITACHI MS4252

Tip size: Ø 7,3 mm
Width: 16,2 mm
Length: 52 mm
Number of tips: 2



REF 108TA5509

Type: HITACHI MS4252

Tip size: Ø 7,3 mm
Width: 16,4 mm
Length: 38,2 mm
Number of tips: 2



REF 108TA5169

Type: HITACHI-MS

Tip size: Ø 12 mm
Width: 16 mm
Length: 86,6 mm
Number of tips: 1

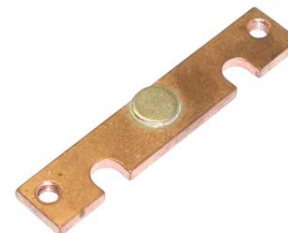

REF 108TA5521

Type: HITACHI-MS31

Tip size: Ø 16 mm
Width: 25,3 mm
Length: 124,2 mm
Number of tips: 1



REF 138TA5814

Type: HITACHI-MS32

Tip size: Ø 9,6 mm
Width: 25,4 mm
Length: 124 mm
Number of tips: 1



REF 138TA6074

Type: HITACHI-MS32/42

Tip size: Ø 10,3 mm
Width: 24 mm
Length: 47 mm
Number of tips: 2



REF 109TA8505

Type: HITACHI-MS41

Tip size: Ø 16 mm
Width: 20 mm
Length: 66 mm
Number of tips: 2

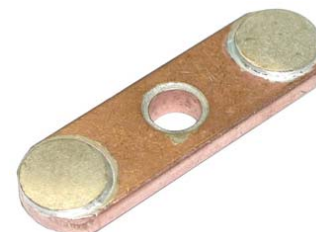

REF 138TA6138



CONTACTS

For all our latest catalogue updates and company info: www.tvh.com

used for: **JAPANESE**

Type: HITACHI-MS4120

Tip size: Ø 16 mm
Width: 20 mm
Length: 110 mm
Number of tips: 1

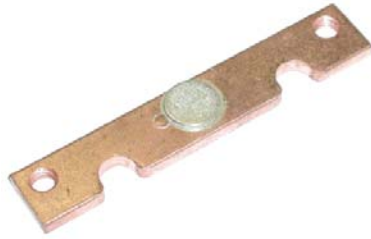

REF 138TA6111

Type: HITACHI-MS42

Tip size: Ø 9,5 mm
Width: 15,8 mm
Length: 41,5 mm
Number of tips: 1



REF 138TA6077

Type: HITACHI-MS42

Tip size: Ø 9,5 mm
Width: 20 mm
Length: 47 mm
Number of tips: 2



REF 138TA6075

Type: HITACHI-MS42

Tip size: Ø 10 mm
Width: 20 mm
Length: 66,5 mm
Number of tips: 2



REF 138TA6076

Type: HITACHI-MS4220

Tip size: Ø 9,5 mm
Width: 20 mm
Length: 110,5 mm
Number of tips: 1



REF 138TA6166

Type: HITACHI-MSx2

Tip size: Ø 9,5 mm
Width: 15,8 mm
Length: 41,3 mm
Number of tips: 1



REF 138TA6113

Type: HITACHI-MSx2

Tip size: Ø 10,2 mm
Width: 16 mm
Length: 41,5 mm
Number of tips: 1



REF 109TA6625

Type: HITACHI-MSx3

Tip size: Ø 16 mm
Width: 20 mm
Length: 66 mm
Number of tips: 2

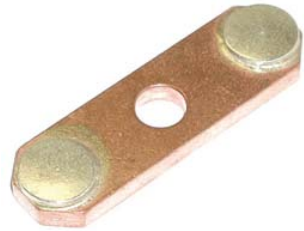

REF 108TA7010

Type: KOMATSU

Tip size: 10 X 15 mm
Width: 15 mm
Length: 51 mm
Number of tips: 1

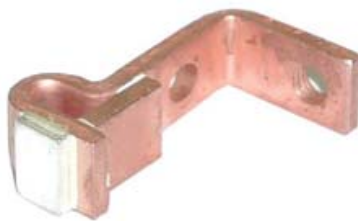

REF 138TA6275

Type: KOMATSU

Tip size: 15 X 15 mm
Width: 16 mm
Length: 68 mm
Number of tips: 1



REF 138TA6143

Type: KOMATSU

Tip size: 14,4 X 19,2 mm
Width: 20 mm
Length: 48 mm
Number of tips: 1



REF 138TA6100

Type: KOMATSU

Tip size: 15 X 19,3 mm
Width: 20 mm
Length: 58 mm
Number of tips: 1



REF 138TA6091

Type: KOMATSU

Tip size: 14 X 19,2 mm
Width: 20 mm
Length: 70 mm
Number of tips: 2



REF 138TA6250

Type: KOMATSU

Tip size: Ø 12 mm
Width: 14 mm
Length: 73,5 mm
Number of tips: 1



REF 132TA2494

JAPANESE

JAPANESE

CONTACTS



For all our latest catalogue updates and company info: www.tvh.com

used for: **JAPANESE**

Type: KOMATSU

Tip size: Ø 13,8 mm
Width: 20 mm
Length: 47,5 mm
Number of tips: 1



REF 108TA6979

Type: KOMATSU

Tip size: Ø 15 mm
Width: 15,8 mm
Length: 68 mm
Number of tips: 1



REF 132TA2521

Type: KOMATSU

Tip size: Ø 15,4 mm
Width: 20 mm
Length: 48 mm
Number of tips: 1



REF 138TA6116

Type: KOMATSU

Tip size: Ø 16 mm
Width: 16 mm
Length: 68 mm
Number of tips: 2

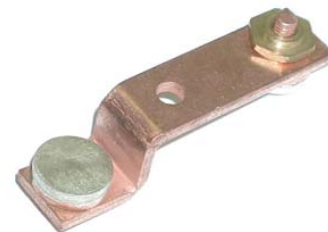

REF 138TA6095

Type: KOMATSU

Tip size: Ø 16 mm
Width: 20 mm
Length: 58 mm
Number of tips: 1

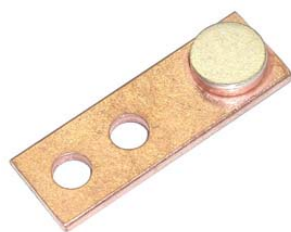

REF 138TA6115

Type: KOMATSU-2

Tip size: Ø 8 mm
Width: 15 mm
Length: 27 mm
Number of tips: 1



REF 138TA5983

Type: KOMATSU-2

Tip size: Ø 10 mm
Width: 12,2 mm
Length: 22 mm
Number of tips: 1



REF 132TA2429

Type: KOMATSU-2

Tip size: Ø 10 mm
Width: 12,4 mm
Length: 52 mm
Number of tips: 2



REF 132TA2122

Type: KOMATSU-4

Tip size: Ø 16,1 mm
Width: 20 mm
Length: 63,6 mm
Number of tips: 2



REF 138TA5879

Type: KOMATSU-4

Tip size: Ø 16,2 mm
Width: 25 mm
Length: 38,5 mm
Number of tips: 1



REF 138TA6130

Type: KYORITSU

Tip size: Ø 8 mm
Width: 15 mm
Length: 77 mm
Number of tips: 2



REF 132TA2502

Type: KYORITSU - CM16TC-KOMATSU

Tip size: Ø 12,8 mm
Width: 19 mm
Length: 53 mm
Number of tips: 1



REF 108TA6901

Type: KYORITSU -CM16A-KOMATSU

Tip size: 10 X 15 mm
Width: 19 mm
Length: 51,7 mm
Number of tips: 1

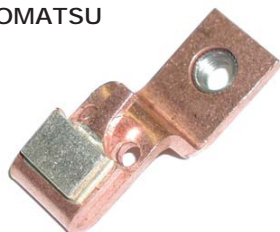

REF 108TA7053

Type: KYORITSU CA10

Tip size: Ø 8 mm
Width: 15 mm
Length: 76 mm
Number of tips: 2



REF 122TA7610

JAPANESE

JAPANESE



CONTACTS

For all our latest catalogue updates and company info: www.tvh.com

used for: **JAPANESE**

Type: KYORITSU CA10

Tip size: Ø 8 mm
Width: 15,2 mm
Length: 42 mm
Number of tips: 2

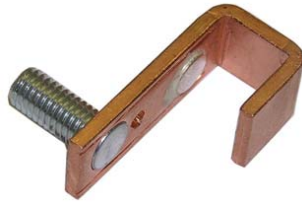

REF 122TA7611

Type: KYORITSU KEIKI

Tip size: Ø 7 mm
Width: 15 mm
Length: 58 mm
Number of tips: 2



REF 138TA6336

Type: KYORITSU KEIKI

Tip size: Ø 12 mm
Width: 22 mm
Length: 60 mm
Number of tips: 2



REF 138TA6333

Type: KYORITSU KEIKI-CM16

Tip size: 10 X 15 mm
Width: 20,3 mm
Length: 37 mm
Number of tips: 1



REF 108TA7066

Type: KYORITSU KEIKI-CM16

Tip size: Ø 11,5 mm
Width: 20,5 mm
Length: 35,5 mm
Number of tips: 1



REF 108TA7379

Type: KYORITSU KEIKI-CM16A

Tip size: 10 X 15 mm
Width: 20 mm
Length: 67 mm
Number of tips: 1



REF 108TA7061

Type: KYORITSU KEIKI-CM16A

Tip size: Ø 11,5 mm
Width: 20 mm
Length: 35 mm
Number of tips: 1



REF 108TA5519

Type: KYORITSU KEIKI-CM16A

Tip size: Ø 13 mm
Width: 20 mm
Length: 67 mm
Number of tips: 1



REF 108TA5174

Type: KYORITSU KEIKI-CM16TC

Tip size: Ø 11,8 mm
Length: 29 mm
Number of tips: 1



REF 108TA6962

Type: KYORITSU KEIKI-CM16TC

Tip size: Ø 12,8 mm
Width: 20 mm
Length: 67,3 mm
Number of tips: 2



REF 108TA6131

Type: KYORITSU KEIKI-CM2A

Tip size: Ø 6 mm
Width: 6,2 mm
Length: 26 mm
Number of tips: 1



REF 108TA7052

Type: KYORITSU KEIKI-CM2A

Tip size: Ø 6 mm
Width: 6,2 mm
Length: 26 mm
Number of tips: 1



REF 108TA7467

Type: KYORITSU KEIKI-CM2A

Tip size: Ø 6 mm
Width: 7 mm
Length: 49,7 mm
Number of tips: 2



REF 108TA5205

Type: KYORITSU KEIKI-CM4TX

Tip size: Ø 5,8 mm
Width: 8 mm
Length: 21 mm
Number of tips: 1



REF 122TA7631

JAPANESE

JAPANESE



used for: JAPANESE

Type: KYORITSU KEIKI-CM4TX

Tip size: Ø 7,9 mm
Width: 8 mm
Length: 35 mm
Number of tips: 2



REF 138TA6283

Type: KYORITSU KEIKI-CM4TX

Tip size: Ø 7,9 mm
Width: 15 mm
Length: 28,5 mm
Number of tips: 1



REF 122TA7629

Type: KYORITSU KEIKI-CM85A

Tip size: Ø 10 mm
Width: 15 mm
Length: 58,2 mm
Number of tips: 1



REF 108TA5677

Type: KYORITSU KEIKI-CM85A

Tip size: Ø 10 mm
Width: 15 mm
Length: 41 mm
Number of tips: 1



REF 108TA5689

Type: KYORITSU KEIKI-CM85TC

Tip size: Ø 7,5 mm
Length: 25 mm
Number of tips: 1



REF 138TA6132

Type: KYORITSU KEIKI-CM85TC

Tip size: Ø 7,5 mm
Width: 15 mm
Length: 41 mm
Number of tips: 1



REF 138TA6133

Type: KYORITSU KEIKI-CM85TC

Tip size: Ø 8 mm
Width: 15 mm
Length: 58,2 mm
Number of tips: 2



REF 138TA6147

Type: KYORITSU KEIKI-G

Tip size: Ø 8 mm
Width: 12 mm
Length: 42 mm
Number of tips: 1



REF 138TA6252

Type: KYORITSU KEIKI-G

Tip size: Ø 9,5 mm
Width: 10 mm
Length: 52,4 mm
Number of tips: 2



REF 138TA6251

Type: KYORITSU KEIKI-G03

Tip size: Ø 7,9 mm
Width: 7 mm
Length: 46 mm
Number of tips: 1



REF 108TA6031

Type: KYORITSU KEIKI-G03

Tip size: Ø 8 mm
Width: 8 mm
Length: 45 mm
Number of tips: 1



REF 108TA6012

Type: KYORITSU KEIKI-G03

Tip size: Ø 10 mm
Width: 10,3 mm
Length: 52,5 mm
Number of tips: 1



REF 138TA6114

Type: KYORITSU KEIKI-G05

Tip size: Ø 13 mm
Width: 14 mm
Length: 40 mm
Number of tips: 1



REF 138TA6078

Type: KYORITSU KEIKI-G051AY

Tip size: Ø 12 mm
Width: 13 mm
Length: 73,5 mm
Number of tips: 2



REF 108TA5811



CONTACTS

For all our latest catalogue updates and company info: www.tvh.com

used for: **JAPANESE**

Type: KYORITSU KEIKI-GN03

Tip size: Ø 8 mm
Width: 8 mm
Length: 32,3 mm
Number of tips: 1



REF 138TA6105

Type: KYORITSU KEIKI-GN03

Tip size: Ø 8 mm
Width: 8 mm
Length: 45 mm
Number of tips: 1



REF 138TA6146

Type: KYORITSU KEIKI-GO51AL

Tip size: Ø 13 mm
Width: 13 mm
Length: 73,5 mm
Number of tips: 1



REF 138TA6291

Type: KYORITSU KEIKI-PA/PT15

Tip size: Ø 14 mm
Width: 15 mm
Length: 36 mm
Number of tips: 1



REF 138TA6158

Type: KYORITSU KEIKI-PA/PT15

Tip size: Ø 14 mm
Width: 15 mm
Length: 53,2 mm
Number of tips: 2



REF 138TA6131

Type: KYORITSU KEIKI-PN12

Tip size: Ø 10 mm
Width: 15 mm
Length: 77,5 mm
Number of tips: 1



REF 138TA6182

Type: KYORITSU KEIKI-PN12

Tip size: Ø 10 mm
Width: 15 mm
Length: 148 mm
Number of tips: 2



REF 138TA6151

Type: KYORITSU KEIKI-PN12A

Tip size: Ø 10 mm
Width: 25 mm
Length: 62 mm
Number of tips: 2

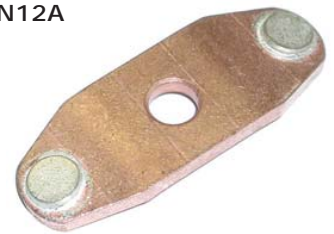

REF 108TA7047

Type: KYORITSU KEIKI-PN12A

Tip size: Ø 10 mm
Width: 25,3 mm
Length: 80 mm
Number of tips: 1

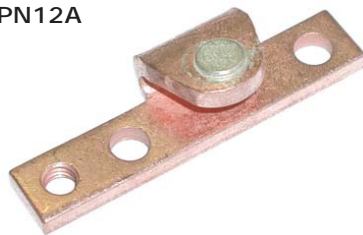

REF 108TA7461

Type: KYORITSU KEIKI-PN12A

Tip size: Ø 10 mm
Width: 25,5 mm
Length: 80 mm
Number of tips: 1



REF 108TA7046

Type: KYORITSU KEIKI-PN12TCW

Tip size: Ø 10 mm
Width: 25,2 mm
Length: 65 mm
Number of tips: 2



REF 138TA5962

Type: KYORITSU KEIKI-PN18A

Tip size: Ø 12 mm
Width: 25 mm
Length: 80 mm
Number of tips: 1

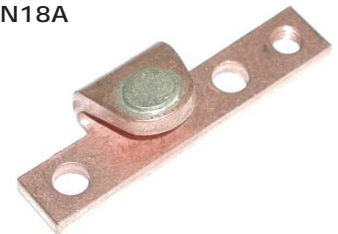

REF 138TA5958

Type: KYORITSU KEIKI-PN18A

Tip size: Ø 12 mm
Width: 25 mm
Length: 80 mm
Number of tips: 1

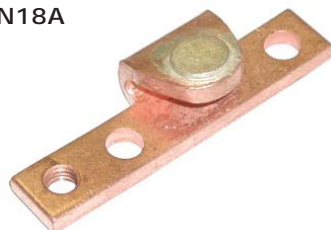

REF 138TA6172

Type: KYORITSU KEIKI-PN18A

Tip size: Ø 12 mm
Width: 25,3 mm
Length: 64,6 mm
Number of tips: 2

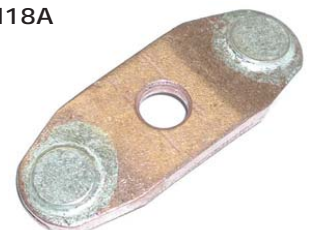

REF 138TA5969

JAPANESE

JAPANESE



used for: JAPANESE

Type: KYORITSU KEIKI-PN8

Tip size: Ø 8 mm
Width: 15 mm
Length: 77 mm
Number of tips: 1



REF 108TA7056

Type: KYORITSU KEIKI-PN8

Tip size: Ø 8 mm
Width: 15 mm
Length: 148,5 mm
Number of tips: 2



REF 108TA7055

Type: KYORITSU KEIKI-PN8A

Tip size: Ø 8 mm
Width: 25,3 mm
Length: 66,2 mm
Number of tips: 2



REF 108TA7054

Type: KYORITSU KEIKI-PT15

Tip size: Ø 14 mm
Width: 20 mm
Length: 77 mm
Number of tips: 1



REF 138TA6129

Type: KYORITSU KEIKI-PT8

Tip size: Ø 10 mm
Width: 14,8 mm
Length: 52,6 mm
Number of tips: 2



REF 138TA6144

Type: KYORITSU KEIKI-PT8

Tip size: Ø 10 mm
Width: 15 mm
Length: 35 mm
Number of tips: 1



REF 138TA6141

Type: KYORITSU KEIKI-PT8

Tip size: Ø 10 mm
Width: 15,3 mm
Length: 75,3 mm
Number of tips: 1



REF 138TA6142

Type: KYORITSU KEIKI-PTS8A

Tip size: Ø 7,3 mm
Width: 15 mm
Length: 118,5 mm
Number of tips: 2

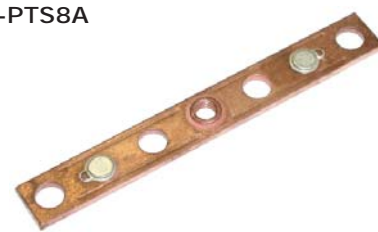

REF 138TA5961

Type: KYORITSU KEIKI-PTS8A

Tip size: Ø 8 mm
Width: 15 mm
Length: 46,2 mm
Number of tips: 2



REF 138TA5973

Type: KYORITSU KEIKI-PTS8A

Tip size: Ø 8 mm
Width: 15,5 mm
Length: 64,8 mm
Number of tips: 1



REF 138TA5982

Type: MEIDEN

Tip size: Ø 10,5 mm
Width: 15 mm
Length: 71,5 mm
Number of tips: 1



REF 138TA6323

Type: MEIDEN MY

Tip size: Ø 10 mm
Length: 29,5 mm
Number of tips: 1



REF 138TA6098

Type: MEIDEN MY

Tip size: Ø 10 mm
Width: 14,7 mm
Length: 58,8 mm
Number of tips: 2



REF 138TA6092

Type: MEIDEN MY

Tip size: Ø 10 mm
Width: 15 mm
Length: 37,5 mm
Number of tips: 1



REF 138TA6093



CONTACTS

For all our latest catalogue updates and company info: www.tvh.com

used for: **JAPANESE**

Type: MEIDEN MY

Tip size: Ø 10 mm
Width: 15 mm
Length: 58 mm
Number of tips: 1



REF 138TA5928

Type: MEIDEN-MA11M

Tip size: Ø 10 mm
Length: 36 mm
Number of tips: 1



REF 138TA6035

Type: MEIDEN-MA11M

Tip size: Ø 10 mm
Width: 15 mm
Length: 61,5 mm
Number of tips: 2



REF 138TA6034

Type: MEIDEN-MA11M,20M

Tip size: Ø 10 mm
Width: 15 mm
Length: 36 mm
Number of tips: 1



REF 138TA6033

Type: MEIDEN-MA20M

Tip size: Ø 10 mm
Width: 15 mm
Length: 61,5 mm
Number of tips: 1



REF 138TA6038

Type: MEIDEN-MA22M

Tip size: 10 X 15 mm
Width: 15 mm
Length: 36 mm
Number of tips: 1



REF 138TA6036

Type: MEIDEN-MA22M

Tip size: 10 X 15 mm
Width: 15 mm
Length: 61,5 mm
Number of tips: 1



REF 138TA6037

Type: MEIDEN-ME250

Tip size: Ø 10 mm
Length: 31,6 mm
Number of tips: 1



REF 138TA6109

Type: MEIDEN-ME250

Tip size: Ø 10 mm
Width: 14,6 mm
Length: 61,5 mm
Number of tips: 1



REF 138TA6212

Type: MEIDEN-ME250

Tip size: Ø 10 mm
Width: 14,7 mm
Length: 61,5 mm
Number of tips: 2



REF 138TA6163

Type: MEIDEN-ME250

Tip size: Ø 10 mm
Width: 15,7 mm
Length: 51 mm
Number of tips: 1



REF 138TA5972

Type: MEIDEN-ME251

Tip size: 10 X 15 mm
Width: 14,4 mm
Length: 61,8 mm
Number of tips: 1



REF 138TA6246

Type: MEIDEN-ME251

Tip size: 10 X 15 mm
Width: 16 mm
Length: 53 mm
Number of tips: 1



REF 138TA6248

Type: MEIDEN-MX140/150

Tip size: 10 X 15 mm
Width: 15,3 mm
Length: 40 mm
Number of tips: 1



REF 138TA5811

JAPANESE

JAPANESE



used for: JAPANESE

Type: MEIDEN-MX140C

Tip size: 14,5 X 14,5 mm
Width: 15 mm
Length: 50 mm
Number of tips: 1



REF 138TA6108

Type: MEIDEN-MX140C

Tip size: Ø 9,4 mm
Width: 15 mm
Length: 66,5 mm
Number of tips: 3

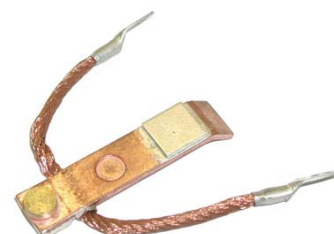

REF 138TA6160

Type: MEIDEN-MX140D

Tip size: 10 X 15 mm
Width: 15 mm
Length: 51,5 mm
Number of tips: 1



REF 138TA6104

Type: MEIDEN-MX140D

Tip size: 10 X 15 mm
Width: 15 mm
Length: 52 mm
Number of tips: 3



REF 138TA6150

Type: MEIDEN-MX150

Tip size: Ø 9 mm
Width: 15 mm
Length: 53 mm
Number of tips: 2



REF 138TA6191

Type: MEIDEN-MX160

Tip size: 9,9 X 14,3 mm
Width: 15 mm
Length: 64 mm
Number of tips: 2



REF 138TA5821

Type: MEIDEN-MX160

Tip size: 10 X 14,6 mm
Width: 20 mm
Length: 57,3 mm
Number of tips: 1



REF 138TA5812

Type: MEIDEN-MX160BC

Tip size: 10 X 14,8 mm
Width: 20 mm
Length: 57,2 mm
Number of tips: 1



REF 138TA6189

Type: MEIDEN-MZ

Tip size: Ø 10,5 mm
Width: 15 mm
Length: 71,4 mm
Number of tips: 1



REF 138TA5924

Type: MEIDEN-MZ

Tip size: Ø 10,5 mm
Width: 16 mm
Length: 71,5 mm
Number of tips: 1



REF 132TA2510

Type: MEIDEN-MZ11

Tip size: Ø 10,3 mm
Length: 30,2 mm
Number of tips: 1



REF 138TA6276

Type: MEIDEN-MZ11

Tip size: Ø 10,3 mm
Width: 15 mm
Length: 49,7 mm
Number of tips: 1



REF 132TA2448

Type: MEIDEN-MZ11

Tip size: Ø 10,3 mm
Width: 15 mm
Length: 71,5 mm
Number of tips: 2



REF 138TA6124

Type: MEIDEN-MZ11/14

Tip size: 9,5 X 14,5 mm
Length: 31,5 mm
Number of tips: 1



REF 110TA8471



CONTACTS

For all our latest catalogue updates and company info: www.tvh.com

used for: **JAPANESE**

Type: MEIDEN-MZ11A

Tip size: Ø 10 mm
Width: 15 mm
Length: 71,5 mm
Number of tips: 2

REF 138TA6161



Type: MEIDEN-MZ14

Tip size: 10 X 15 mm
Width: 15,4 mm
Length: 51 mm
Number of tips: 1

REF 138TA6084



Type: MEIDEN-MZ14A

Tip size: 10 X 14,5 mm
Width: 15 mm
Length: 71,8 mm
Number of tips: 2

REF 138TA6159



Type: MEIDEN-MZ14A

Tip size: 10 X 14,9 mm
Width: 15 mm
Length: 71,8 mm
Number of tips: 2

REF 138TA6094



Type: MEIDEN-MZ14MA

Tip size: 10 X 15 mm
Length: 30,6 mm
Number of tips: 1

REF 108TA5178



Type: MEIDEN-MZ14MA

Tip size: 10 X 15 mm
Width: 15 mm
Length: 72 mm
Number of tips: 1

REF 138TA6145



Type: MEIDEN-MZ2.

Tip size: 10 X 15 mm
Width: 15 mm
Length: 71,8 mm
Number of tips: 1

REF 138TA6157



Type: MEIDEN-MZ2.

Tip size: 10 X 14,2 mm
Width: 15 mm
Length: 72 mm
Number of tips: 1

REF 138TA6190



Type: MEIDEN-MZ2.

Tip size: 12 X 15 mm
Width: 15,1 mm
Length: 52,4 mm
Number of tips: 1

REF 138TA5806



Type: MEIDEN-MZ2.

Tip size: 12 X 15 mm
Width: 15,3 mm
Length: 72 mm
Number of tips: 1

REF 138TA5809



Type: NIKKO

Tip size: 8 X 28 mm
Width: 18,7 mm
Length: 82,7 mm
Number of tips: 1

REF 132TA2321



Type: NIKKO

Tip size: 8 X 28 mm
Width: 19 mm
Length: 99,7 mm
Number of tips: 1

REF 108TA6969



Type: NIKKO

Tip size: 8 X 28 mm
Width: 19 mm
Length: 99,7 mm
Number of tips: 1

REF 108TA6955



Type: NIKKO

Tip size: 8 X 28 mm
Width: 20 mm
Length: 111 mm
Number of tips: 1

REF 132TA2292

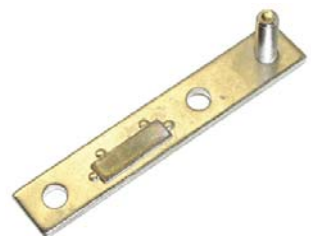

JAPANESE

JAPANESE

CONTACTS



For all our latest catalogue updates and company info: www.tvh.com

used for: **JAPANESE**

Type: NIKKO

Tip size: 8 X 28 mm
Width: 20 mm
Length: 111 mm
Number of tips: 1



REF 108TA6820

Type: NIKKO

Tip size: 30,7 X 8 mm
Width: 25 mm
Length: 50 mm
Number of tips: 2



REF 109TA9820

Type: NIKKO

Tip size: 5 X 25 mm
Width: 25,8 mm
Length: 51,5 mm
Number of tips: 2



REF 132TA2369

Type: NIKKO-KOM333

Tip size: 5 X 25 mm
Width: 25 mm
Length: 44 mm
Number of tips: 2

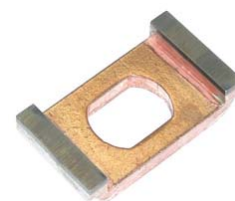

REF 138TA6126

Type: NIKKO-KOM444

Tip size: 8 X 28 mm
Width: 19 mm
Length: 83,5 mm
Number of tips: 1



REF 138TA6096

Type: NIKKO-KOM444

Tip size: 8 X 28 mm
Width: 19 mm
Length: 83,5 mm
Number of tips: 1



REF 138TA6097

Type: NIKKO-KOM444/555

Tip size: 5 X 25 mm
Width: 25,3 mm
Length: 80,5 mm
Number of tips: 2



REF 138TA6118

Type: NISSAN

Tip size: 8 X 24,5 mm
Width: 11,5 mm
Length: 65 mm
Number of tips: 2



REF 108TA7041

Type: NISSAN

Tip size: 12,2 X 17,8 mm
Width: 12,5 mm
Length: 76 mm
Number of tips: 1



REF 108TA7040

Type: NISSAN

Tip size: 12,5 X 18 mm
Width: 12,5 mm
Length: 76 mm
Number of tips: 1



REF 132TA2458

Type: NISSAN

Tip size: 12,5 X 18 mm
Width: 18 mm
Length: 40 mm
Number of tips: 2



REF 132TA2507

Type: NISSAN

Tip size: 8 X 24,2 mm
Width: 21 mm
Length: 86 mm
Number of tips: 2



REF 108TA6982

Type: NYK

Tip size: 10 X 10 mm
Width: 15 mm
Length: 59 mm
Number of tips: 1



REF 132TA2551

Type: NYK

Tip size: Ø 19 mm
Length: 22 mm
Number of tips: 1



REF 138TA6020

JAPANESE

JAPANESE



CONTACTS

For all our latest catalogue updates and company info: www.tvh.com

used for: **JAPANESE**

Type: NYK-MS34

Tip size: Ø 9,5 mm
Width: 14 mm
Length: 112 mm
Number of tips: 2

REF 138TA6064



Type: NYK-MS34

Tip size: Ø 9,5 mm
Width: 15 mm
Length: 33 mm
Number of tips: 1

REF 138TA6059



Type: NYK-MS34

Tip size: Ø 9,5 mm
Width: 15 mm
Length: 59 mm
Number of tips: 1

REF 138TA6061



Type: NYK-MS34

Tip size: Ø 9,5 mm
Width: 15 mm
Length: 59 mm
Number of tips: 2

REF 138TA6060



Type: NYK-MS44

Tip size: Ø 11 mm
Width: 15 mm
Length: 40 mm
Number of tips: 1

REF 138TA6051



Type: NYK-MS44

Tip size: Ø 11 mm
Width: 15 mm
Length: 54,3 mm
Number of tips: 1

REF 108TA5815



Type: NYK-MS44

Tip size: Ø 11 mm
Width: 15 mm
Length: 75 mm
Number of tips: 1

REF 138TA6053



Type: NYK-MS44

Tip size: Ø 11 mm
Width: 15 mm
Length: 75 mm
Number of tips: 2

REF 138TA6052



Type: NYK-MS44

Tip size: Ø 11 mm
Width: 15 mm
Length: 127 mm
Number of tips: 2

REF 138TA6054



Type: NYK-MS51

Tip size: Ø 13 mm
Length: 129 mm
Number of tips: 2

REF 138TA5963



Type: NYK-MS56

Tip size: Ø 13 mm
Length: 21 mm
Number of tips: 1

REF 138TA6022



Type: NYK-MS56

Tip size: Ø 13 mm
Width: 19 mm
Length: 43 mm
Number of tips: 1

REF 138TA6005

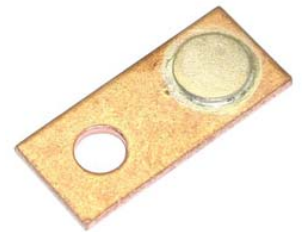

Type: NYK-MS9105

Tip size: Ø 16 mm
Length: 25,5 mm
Number of tips: 1

REF 138TA6023



Type: SHINKO

Tip size: 16 X 19 mm
Width: 20 mm
Length: 30,5 mm
Number of tips: 1

REF 138TA6067



CONTACTS



For all our latest catalogue updates and company info: www.tvh.com

used for: **JAPANESE**

Type: SHINKO

Tip size: 16 X 19 mm
Width: 20 mm
Length: 106,4 mm
Number of tips: 1



REF 138TA5936

Type: SHINKO

Tip size: \varnothing 12 mm
Width: 20 mm
Length: 145 mm
Number of tips: 1



REF 138TA6305

Type: SHINKO

Tip size: \varnothing 16 mm
Length: 32,6 mm
Number of tips: 1



REF 138TA6279

Type: SHINKO

Tip size: \varnothing 16 mm
Length: 101 mm
Number of tips: 1



REF 134TA2201

Type: TCM

Tip size: 18 X 20 mm
Width: 18 mm
Length: 98 mm
Number of tips: 1



REF 138TA6148

Type: TCM

Tip size: 18 X 19 mm
Width: 18,3 mm
Length: 111,5 mm
Number of tips: 1



REF 138TA6081

Type: TCM

Tip size: 19,2 X 20,3 mm
Width: 20 mm
Length: 57,7 mm
Number of tips: 1



REF 138TA6165

Type: TCM

Tip size: 18 X 19,2 mm
Width: 20 mm
Length: 58 mm
Number of tips: 1



REF 108TA6914

Type: TCM

Tip size: \varnothing 15 mm
Length: 15 mm
Number of tips: 1



REF 108TA5175

Type: TCM

Tip size: \varnothing 16 mm
Width: 18 mm
Length: 97,5 mm
Number of tips: 2



REF 108TA5181

Type: TCM-1

Tip size: \varnothing 14,7 mm
Width: 18 mm
Length: 112 mm
Number of tips: 2



REF 108TA6913

Type: TCM-1

Tip size: \varnothing 15,6 mm
Width: 18,5 mm
Length: 59,5 mm
Number of tips: 1



REF 108TA6912

Type: TCM-1

Tip size: \varnothing 16 mm
Width: 20 mm
Length: 57,5 mm
Number of tips: 1



REF 138TA6082

Type: TOYOTA

Tip size: 10 X 15 mm
Length: 27 mm
Number of tips: 1

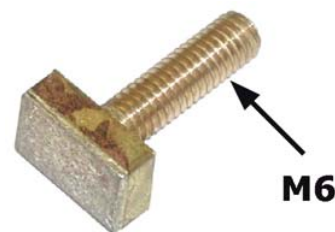

REF 138TA6122

JAPANESE

JAPANESE



CONTACTS

For all our latest catalogue updates and company info: www.tvh.com

used for: **JAPANESE**

Type: TOYOTA

Tip size: 14 X 22,3 mm
Width: 14,5 mm
Length: 25 mm
Number of tips: 1

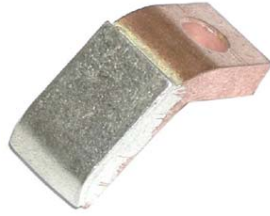

REF 108TA6987

Type: TOYOTA

Tip size: 10 X 15 mm
Width: 15 mm
Length: 50,5 mm
Number of tips: 1

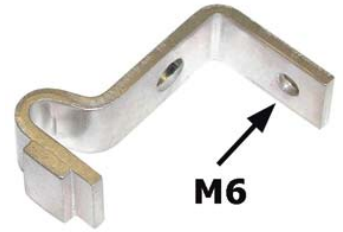

REF 138TA6080

Type: TOYOTA

Tip size: 14,7 X 16 mm
Width: 15 mm
Length: 52 mm
Number of tips: 1



REF 138TA6089

Type: TOYOTA

Tip size: 15 X 20 mm
Width: 15 mm
Length: 57 mm
Number of tips: 1



REF 138TA6102

Type: TOYOTA

Tip size: 9,8 X 14,2 mm
Width: 15 mm
Length: 72 mm
Number of tips: 2



REF 138TA6079

Type: TOYOTA

Tip size: 15 X 24,2 mm
Width: 15,2 mm
Length: 25,3 mm
Number of tips: 1



REF 108TA7505

Type: TOYOTA

Tip size: 10 X 15 mm
Width: 15,4 mm
Length: 51 mm
Number of tips: 1

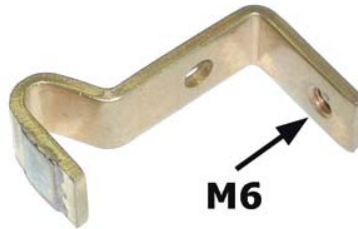

REF 138TA6083

Type: TOYOTA

Tip size: 14,2 X 14,8 mm
Width: 16 mm
Length: 57,4 mm
Number of tips: 1

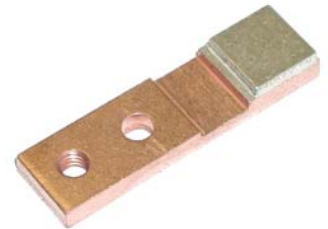

REF 138TA6112

Type: TOYOTA

Tip size: 14,5 X 30,2 mm
Width: 18 mm
Length: 99 mm
Number of tips: 1



REF 138TA6164

Type: TOYOTA

Tip size: 15 X 20 mm
Width: 20 mm
Length: 58 mm
Number of tips: 1



REF 138TA6107

Type: TOYOTA

Tip size: 18 X 29 mm
Width: 20 mm
Length: 62 mm
Number of tips: 1

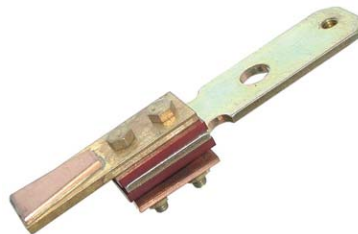

REF 108TA7396

Type: TOYOTA

Tip size: 10,3 X 29,2 mm
Width: 20,2 mm
Length: 62,3 mm
Number of tips: 1

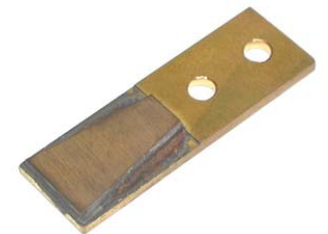

REF 108TA7367

Type: TOYOTA

Tip size: Ø 9 mm
Width: 14 mm
Length: 71 mm
Number of tips: 2



REF 108TA5203

Type: TOYOTA

Tip size: Ø 9 mm
Width: 15 mm
Length: 53 mm
Number of tips: 3



REF 108TA7452

JAPANESE

JAPANESE



used for: JAPANESE

Type: TOYOTA

Tip size: Ø 9 mm
Width: 15 mm
Length: 53 mm
Number of tips: 2



REF 108TA7003

Type: TOYOTA

Tip size: Ø 9 mm
Width: 15 mm
Length: 66,5 mm
Number of tips: 3



REF 138TA6106

Type: TOYOTA

Tip size: Ø 9,2 mm
Width: 15,3 mm
Length: 65 mm
Number of tips: 3



REF 108TA7453

Type: TOYOTA

Tip size: Ø 9,2 mm
Width: 15,3 mm
Length: 66 mm
Number of tips: 2



REF 108TA7448

Type: TOYOTA

Tip size: Ø 13 mm
Length: 17,5 mm
Number of tips: 1



REF 138TA6121

Type: TOYOTA

Tip size: Ø 13,5 mm
Width: 18 mm
Length: 37,8 mm
Number of tips: 1



REF 138TA6099

Type: TOYOTA

Tip size: Ø 14 mm
Width: 15 mm
Length: 46 mm
Number of tips: 1



REF 138TA6245

Type: TOYOTA

Tip size: Ø 14 mm
Width: 15 mm
Length: 76,4 mm
Number of tips: 1



REF 138TA6247

Type: TOYOTA

Tip size: Ø 15,8 mm
Length: 18,5 mm
Number of tips: 1



REF 138TA6154

Type: TOYOTA-CO

Tip size: Ø 11 mm
Width: 15 mm
Length: 76,8 mm
Number of tips: 2



REF 138TA5815

Type: TOYOTA-NO

Tip size: Ø 11 mm
Width: 14,9 mm
Length: 76,2 mm
Number of tips: 1



REF 138TA5816

Type: TOYOTA-NO/CO

Tip size: Ø 11 mm
Width: 15,7 mm
Length: 29,4 mm
Number of tips: 1



REF 138TA5819

Look up
these parts via

PS ProductSearch



CONTACT KITS

For all our latest catalogue updates and company info: www.tvh.com

used for: **JAPANESE**

Type: HITACHI - MS42
Tip size: Ø 10 mm



REF 135TA2418

Type: HITACHI - SPNO
Tip size: Ø 16 mm

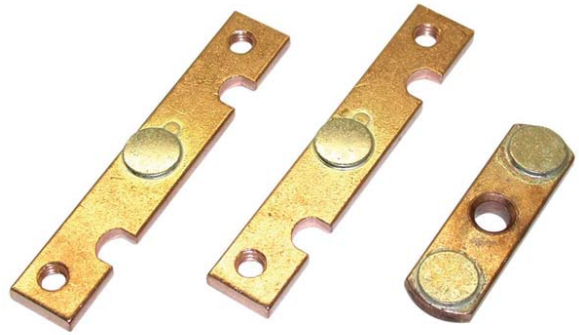

REF 132TA3329

Type: HITACHI - SPNO
Tip size: Ø 16 mm

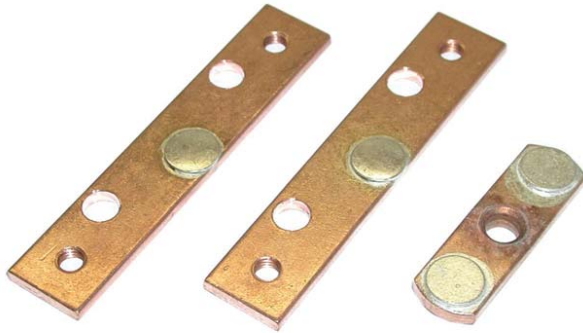

REF 133TA7512

Type: HITACHI - SPCO
Tip size: Ø 10 mm

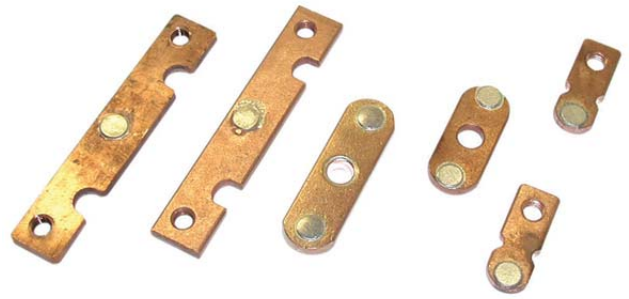

REF 133TA7510

Type: HITACHI - SPNC
Tip size: Ø 16 mm



REF 111TA3733

Type: KYORITSU KEIKI - CM16TC
Tip size: Ø 12,8 mm



REF 133TA6056

Type: KYORITSU KEIKI - G031AK
Tip size: Ø 10 mm



REF 122TA7683

Type: KYORITSU KEIKI - G05
Tip size: Ø 13 mm



REF 111TA3739

JAPANESE

JAPANESE



used for: JAPANESE

Type: KYORITSU KEIKI - PN18A
Tip size: Ø 12 mm



REF 132TA3341

Type: KYORITSU KEIKI - PT
Tip size: Ø 14 mm

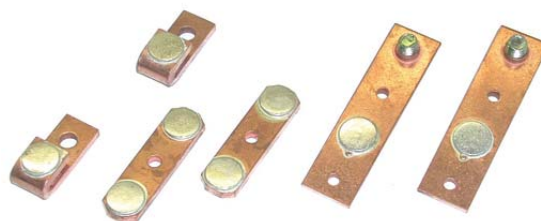

REF 133TA6007

Type: KYORITSU KEIKI - TOYOTA-DRIVE
Tip size: Ø 12,8 mm



REF 122TA7515

Type: KYORITSU KEIKI - TOYOTA-PUMP
Tip size: Ø 13 mm



REF 122TA7514

Type: KYORITSU KEIKI - TOYOTA-SHORT
Tip size: 10 X 15 mm



REF 122TA7513

Type: MEIDEN - MA11
Tip size: Ø 10 mm



REF 133TA7513

Type: MEIDEN - MA20
Tip size: Ø 10 mm



REF 133TA7518

Type: MEIDEN - MA22
Tip size: 10 X 15 mm



REF 138TA6522



CONTACT KITS

For all our latest catalogue updates and company info: www.tvh.com

used for: **JAPANESE**

Type: MEIDEN - MY
Tip size: Ø 10 mm

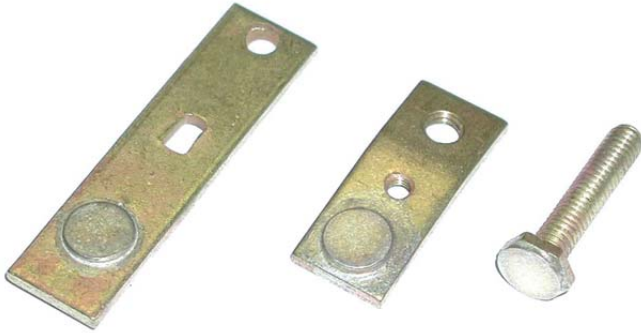

REF 116TA6991

Type: MEIDEN - MZ11A
Tip size: Ø 10,3 mm



REF 138TA6523

Type: MEIDEN - MZ2
Tip size: 12 X 15 mm

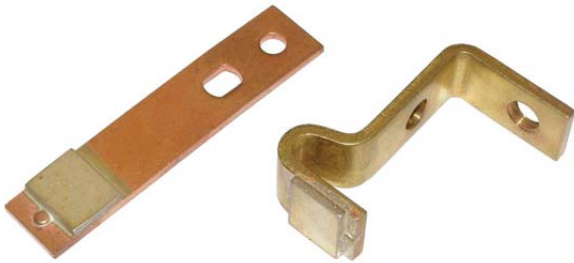

REF 133TA7753

Type: MEIDEN-ME250
Tip size: Ø 10 mm



REF 123TA1944

Type: MEIDEN-ME251
Tip size: 10 X 15 mm



REF 133TA7602

Type: MEIDEN-MX140
Tip size: 10 X 15 mm

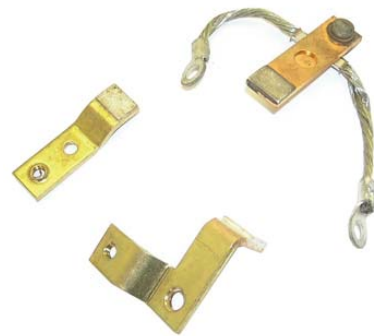

REF 138TA6524

Type: MEIDEN-MX150
Tip size: 10 X 15 mm



REF 138TA6526

Type: MEIDEN-MX160BC
Tip size: 10 X 15 mm

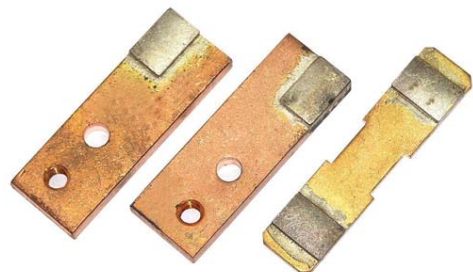

REF 122TA7669

JAPANESE

JAPANESE

CONTACT KITS



For all our latest catalogue updates and company info: www.tvh.com

used for: **JAPANESE**

Type: MEIDEN-MY22
Tip size: \varnothing 10 mm

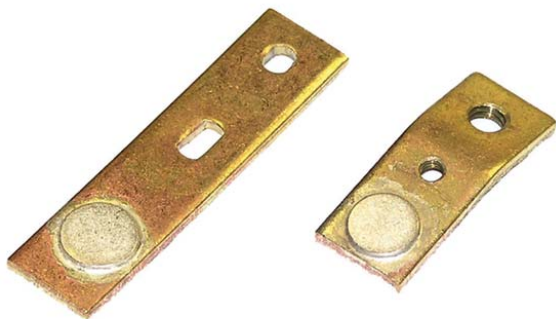

REF 123TA9092

Type: MEIDEN-MZ01MA
Tip size: 10 X 15 mm



REF 138TA6527

Type: MEIDEN-MZ14A
Tip size: 10 X 15 mm

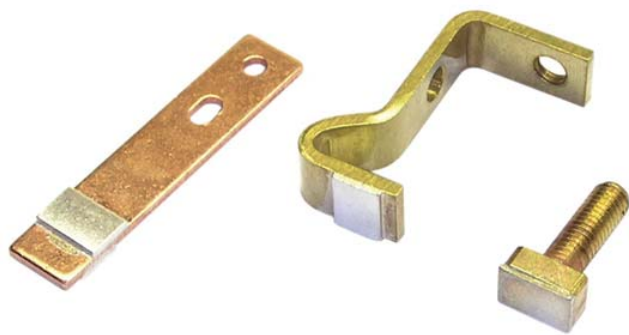

REF 138TA6525

Type: MEIDEN-MZ14MA
Tip size: 10 X 15 mm



REF 123TA9093

Type: MEIDEN-MZ24MA
Tip size: 10 X 15 mm



REF 138TA6528

Type: NIKKO - KOM333
Tip size: 8 X 28 mm



REF 108TA8113

Type: NIKKO - KOM444
Tip size: 8 X 28 mm

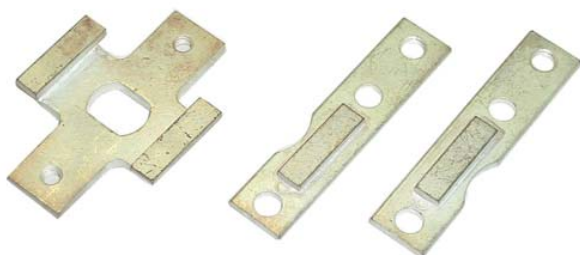

REF 132TA3105

Type: NYK-MS3400
Tip size: \varnothing 9,5 mm



REF 132TA3328

JAPANESE

JAPANESE

CONTACT KITS



For all our latest catalogue updates and company info: www.tvh.com

used for: **JAPANESE**

Type: NYK-MS3403 DPCO
Tip size: Ø 9,5 mm



REF 133TA7507

Type: NYK-MS3403 SPCO
Tip size: Ø 9,5 mm



REF 133TA7506

Type: NYK-MS44
Tip size: Ø 11 mm



REF 132TA3346

JAPANESE

Look up
these parts via

PS ProductSearch

JAPANESE



TOTALSOURCE®

Look up
these parts via

PS ProductSearch

used for:
OTHER MAKES

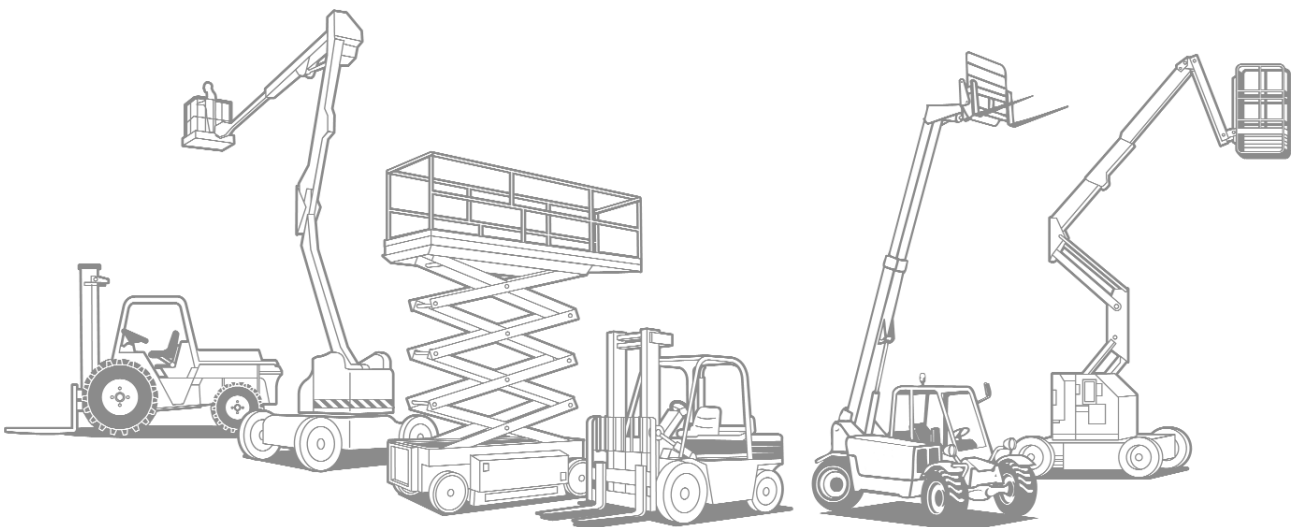



CONTACTS

For all our latest catalogue updates and company info: www.tvh.com

used for: **OTHER MAKES**

Type:

Tip size: 12 X 15,7 mm
Width: 15,7 mm
Length: 22 mm
Number of tips: 1



REF 138TA6349

Type:

Width: 16 mm
Length: 22 mm
Number of tips: 0



REF 132TA2516

Type:

Tip size: 19 X 25,4 mm
Width: 19 mm
Length: 25,4 mm
Number of tips: 1



REF 109TA7139

Type:

Tip size: 13 X 19 mm
Width: 22 mm
Length: 66 mm
Number of tips: 1



REF 132TA2467

Type:

Width: 25,4 mm
Length: 22,5 mm
Number of tips: 0



REF 138TA6338

Type:

Width: 31,8 mm
Length: 35 mm
Number of tips: 0



REF 138TA6341

Type:

Tip size: Ø 15 mm
Width: 16 mm
Length: 27 mm
Number of tips: 1



REF 138TA6344

Type:

Tip size: Ø 16 mm
Length: 17 mm
Number of tips: 1



REF 138TA6343

Type:

Tip size: Ø 16 mm
Width: 22 mm
Length: 34,5 mm
Number of tips: 1



REF 138TA6342

Type:

Tip size: Ø 17 mm
Width: 15 mm
Length: 66 mm
Number of tips: 1



REF 132TA2545

Type:

Tip size: Ø 19 mm
Width: 19 mm
Length: 66 mm
Number of tips: 1



REF 134TA2298

Type:

Tip size: Ø 19 mm
Width: 20 mm
Length: 63 mm
Number of tips: 1



REF 132TA2546

Type: BALCANCAR-KPD2

Tip size: Ø 6 mm
Width: 6 mm
Length: 23,3 mm
Number of tips: 1



REF 132TA2441

Type: BALCANCAR-KPD2

Tip size: Ø 6 mm
Width: 6 mm
Length: 43 mm
Number of tips: 2



REF 132TA2439



used for: OTHER MAKES

Type: BALKANCAR-KPD7

Tip size: Ø 16 mm
Width: 20 mm
Length: 80 mm
Number of tips: 1



REF 132TA2442

Type: BALKANCAR-KPD7

Tip size: Ø 16 mm
Width: 20 mm
Length: 82,5 mm
Number of tips: 2



REF 132TA2440

Type: BALKANCAR

Tip size: 15 X 20 mm
Width: 16 mm
Length: 48,3 mm
Number of tips: 1



REF 109TA7990

Type: BALKANCAR

Tip size: 14 X 16 mm
Width: 16 mm
Length: 76,3 mm
Number of tips: 1



REF 110TA2635

Type: BALKANCAR

Tip size: Ø 22,2 mm
Length: 16 mm
Number of tips: 1



REF 138TA6228

Type: BALKANCAR - TICINO

Tip size: 7,3 X 11 mm
Width: 20,1 mm
Length: 36,7 mm
Number of tips: 2

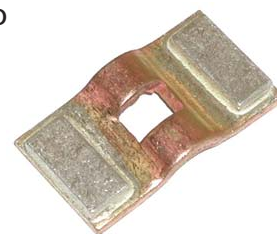

REF 108TA5956

Type: BALKANCAR-KPD5

Tip size: Ø 12 mm
Width: 11,8 mm
Length: 51 mm
Number of tips: 1



REF 138TA5959

Type: BALKANCAR-KPD5

Tip size: Ø 12 mm
Width: 12 mm
Length: 69 mm
Number of tips: 2



REF 138TA5960

Type: BALKANCAR-KPE4

Tip size: Ø 10 mm
Width: 10 mm
Length: 65 mm
Number of tips: 2



REF 138TA5837

Type: BALKANCAR-KPE4

Tip size: Ø 10 mm
Width: 10,1 mm
Length: 44 mm
Number of tips: 1



REF 138TA5826

Type: BALKANCAR-KPE6

Tip size: Ø 14 mm
Width: 14,2 mm
Length: 73,7 mm
Number of tips: 2



REF 138TA6155

Type: BALKANCAR-KPE6

Tip size: Ø 14 mm
Width: 14,3 mm
Length: 65 mm
Number of tips: 1



REF 138TA6156

Type: BALKANCAR-TICINO

Tip size: 7,4 X 15,5 mm
Width: 24 mm
Length: 80 mm
Number of tips: 2



REF 108TA6130

Type: BALKANCAR-TICINO

Tip size: 7,2 X 15,9 mm
Width: 30 mm
Length: 29 mm
Number of tips: 1



REF 108TA5972



CONTACTS

For all our latest catalogue updates and company info: www.tvh.com

used for: **OTHER MAKES**

Type: **BALKANCAR-TICINO**

Tip size: 7,5 X 15 mm
Width: 30 mm
Length: 29 mm
Number of tips: 1

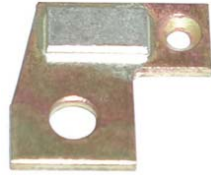

REF 108TA5971

Type: **CESAB**

Tip size: 8,7 X 10 mm
Width: 10 mm
Length: 26,3 mm
Number of tips: 1



REF 138TA6361

Type: **CESAB**

Tip size: 8 X 8 mm
Width: 10,5 mm
Length: 60 mm
Number of tips: 1



REF 132TA2533

Type: **CESAB**

Tip size: 18,8 X 18,8 mm
Width: 20 mm
Length: 28,5 mm
Number of tips: 1



REF 138TA5833

Type: **CESAB**

Tip size: 18 X 20 mm
Width: 20 mm
Length: 90 mm
Number of tips: 2



REF 138TA5832

Type: **CESAB**

Tip size: 19 X 19 mm
Width: 20 mm
Length: 138,2 mm
Number of tips: 1



REF 138TA5976

Type: **CESAB**

Tip size: 18 X 20 mm
Width: 20 mm
Length: 138,3 mm
Number of tips: 2



REF 138TA6273

Type: **CESAB**

Tip size: Ø 15 mm
Width: 15,2 mm
Length: 27,4 mm
Number of tips: 1



REF 138TA5829

Type: **CESAB**

Tip size: Ø 15 mm
Width: 15,2 mm
Length: 53,5 mm
Number of tips: 1



REF 138TA6355

Type: **CESAB-1-NO**

Tip size: 17,7 X 19,4 mm
Width: 20 mm
Length: 102,6 mm
Number of tips: 1



REF 138TA5825

Type: **CESAB-2-CO**

Tip size: 18 X 20 mm
Width: 20 mm
Length: 102 mm
Number of tips: 2



REF 138TA5905

Type: **CESAB-3-NO**

Tip size: 17,8 X 20 mm
Width: 20 mm
Length: 119,5 mm
Number of tips: 1

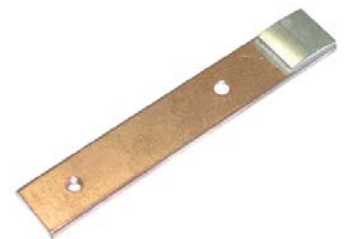

REF 138TA5888

Type: **CESAB-4-CO**

Tip size: 18 X 20 mm
Width: 20 mm
Length: 118,8 mm
Number of tips: 2



REF 138TA5839

Type: **CLARK**

Width: 8,5 mm
Length: 41,6 mm
Number of tips: 0



REF 108TA5389



used for: OTHER MAKES

Type: CLARK

Tip size: 12,7 X 16 mm
Width: 16,2 mm
Length: 47,7 mm
Number of tips: 2



REF 110TA2660

Type: CLARK

Tip size: 19 X 19 mm
Width: 19 mm
Length: 19 mm
Number of tips: 1



REF 108TA7312

Type: CLARK

Tip size: Ø 6 mm
Width: 13 mm
Length: 30,6 mm
Number of tips: 2



REF 138TA6221

Type: CLARK

Tip size: Ø 9,6 mm
Width: 9,7 mm
Length: 18,3 mm
Number of tips: 2



REF 108TA7408

Type: CLARK

Tip size: Ø 16 mm
Width: 16 mm
Length: 45 mm
Number of tips: 1



REF 138TA6198

Type: CLARK

Tip size: Ø 16 mm
Width: 19,2 mm
Length: 63 mm
Number of tips: 1



REF 138TA6234

Type: CLARK

Tip size: Ø 16 mm
Width: 19,3 mm
Length: 41,8 mm
Number of tips: 1



REF 138TA6199

Type: CLARK

Tip size: Ø 16 mm
Width: 19,4 mm
Length: 92,8 mm
Number of tips: 2



REF 108TA7333

Type: CLARK

Tip size: Ø 22 mm
Width: 22,3 mm
Length: 109,2 mm
Number of tips: 2



REF 108TA7449

Type: CLARK-4

Tip size: Ø 16 mm
Width: 16 mm
Length: 42,3 mm
Number of tips: 1



REF 138TA6218

Type: CLARK-4

Tip size: Ø 16 mm
Width: 16 mm
Length: 91 mm
Number of tips: 2



REF 138TA6203

Type: CLARK-4

Tip size: Ø 16 mm
Width: 19 mm
Length: 52,4 mm
Number of tips: 1



REF 138TA6202

Type: CLARK-CLIPPER

Tip size: 3 X 8 mm
Width: 8 mm
Length: 32 mm
Number of tips: 2



REF 108TA7297

Type: CLARK-CLIPPER

Tip size: 16,1 X 17,8 mm
Width: 17,9 mm
Length: 20 mm
Number of tips: 1



REF 138TA5945



CONTACTS

For all our latest catalogue updates and company info: www.tvh.com

used for: **OTHER MAKES**

Type: CLARK-CLIPPER

Tip size: 15,5 X 17,7 mm
Width: 17,9 mm
Length: 54 mm
Number of tips: 1



REF 138TA5981

Type: CLARK-CLIPPER

Tip size: 16,8 X 18 mm
Width: 18 mm
Length: 68 mm
Number of tips: 1



REF 138TA6224

Type: CLARK-CLIPPER

Tip size: 17,8 X 15,9 mm
Width: 18 mm
Length: 88 mm
Number of tips: 2



REF 108TA5327

Type: CLARK-CLIPPER

Tip size: 16 X 18 mm
Width: 18 mm
Length: 96 mm
Number of tips: 2



REF 138TA6207

Type: CLARK-NO

Tip size: 16,6 X 18,1 mm
Width: 18,2 mm
Length: 96,1 mm
Number of tips: 1



REF 138TA5939

Type: CLARK-UNELEC

Tip size: 15,9 X 19 mm
Width: 19 mm
Length: 25 mm
Number of tips: 1



REF 138TA5926

Type: CLARK-UNELEC

Tip size: 18,7 X 18,7 mm
Width: 19,2 mm
Length: 106 mm
Number of tips: 1



REF 138TA5935

Type: CLARK-UNELEC

Tip size: Ø 15,8 mm
Width: 19,1 mm
Length: 41,5 mm
Number of tips: 1



REF 138TA5946

Type: CLARK-UNELEC

Tip size: Ø 15,9 mm
Width: 19 mm
Length: 95,2 mm
Number of tips: 2



REF 138TA5941

Type: FIAT

Width: 13,8 mm
Length: 63,3 mm
Number of tips: 0



REF 138TA5980

Type: FIAT

Width: 15 mm
Length: 23 mm
Number of tips: 0



REF 118TA4150

Type: FIAT

Width: 16,2 mm
Length: 121 mm
Number of tips: 0



REF 138TA5840

Type: FIAT

Width: 20 mm
Length: 145 mm
Number of tips: 0



REF 138TA6136

Type: FIAT

Tip size: Ø 14 mm
Width: 15 mm
Length: 25 mm
Number of tips: 1



REF 138TA6169



used for: OTHER MAKES

Type: FIAT

Tip size: Ø 15 mm
Width: 16 mm
Length: 120,8 mm
Number of tips: 1

REF 138TA5965



Type: FIAT

Tip size: Ø 15 mm
Width: 19,2 mm
Length: 63 mm
Number of tips: 1

REF 138TA6205



Type: FIAT

Tip size: Ø 15,5 mm
Width: 14,2 mm
Length: 45,6 mm
Number of tips: 1

REF 138TA6325



Type: FIAT

Tip size: Ø 16 mm
Width: 16 mm
Length: 67,3 mm
Number of tips: 2

REF 108TA5605



Type: FIAT

Tip size: Ø 18 mm
Length: 52,2 mm
Number of tips: 1

REF 138TA5824



Type: FIAT

Tip size: Ø 18 mm
Width: 20 mm
Length: 145 mm
Number of tips: 1

REF 108TA5159



Type: FIAT

Tip size: Ø 18,3 mm
Length: 20,4 mm
Number of tips: 1

REF 108TA6029



Type: FIAT

Tip size: Ø 18,5 mm
Width: 20,3 mm
Length: 145,7 mm
Number of tips: 1

REF 138TA5966



Type: FIAT

Tip size: Ø 18,8 mm
Width: 20 mm
Length: 87 mm
Number of tips: 1

REF 115TA5490



Type: FIAT

Tip size: Ø 18,8 mm
Width: 20 mm
Length: 108 mm
Number of tips: 2

REF 115TA5491



Type: FIAT

Tip size: Ø 19 mm
Width: 19,2 mm
Length: 27,8 mm
Number of tips: 1

REF 138TA5938

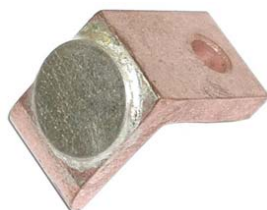

Type: JOHN MORRIS

Tip size: Ø 16 mm
Length: 26,4 mm
Number of tips: 1

REF 138TA5846



Type: JOHN MORRIS

Tip size: Ø 19 mm
Length: 81,4 mm
Number of tips: 1

REF 108TA7319



Type: JOHN MORRIS-CO

Tip size: Ø 16 mm
Width: 19 mm
Length: 108 mm
Number of tips: 2

REF 138TA6177





CONTACTS

For all our latest catalogue updates and company info: www.tvh.com

used for: **OTHER MAKES**

Type: JOHN MORRIS-DP

Tip size: Ø 16 mm
Width: 19,4 mm
Length: 96 mm
Number of tips: 2



REF 138TA5923

Type: JOHN MORRIS-DP

Tip size: Ø 16 mm
Width: 19,7 mm
Length: 100,8 mm
Number of tips: 2



REF 138TA5917

Type: JOHN MORRIS-NO

Tip size: Ø 15,4 mm
Width: 19,5 mm
Length: 107,5 mm
Number of tips: 1



REF 138TA5925

Type: KALMAR

Tip size: Ø 15,9 mm
Width: 20 mm
Length: 99 mm
Number of tips: 1



REF 138TA6211

Type: KALMAR-CLIMAX

Tip size: 19 X 22 mm
Width: 19 mm
Length: 22 mm
Number of tips: 1



REF 138TA5919

Type: KALMAR-CLIMAX

Tip size: 19 X 22,4 mm
Width: 25,4 mm
Length: 25,4 mm
Number of tips: 1



REF 138TA5890

Type: KALMAR-CLIMAX

Tip size: 22 X 22,2 mm
Width: 25,4 mm
Length: 121,3 mm
Number of tips: 1



REF 138TA6280

Type: KALMAR-CLIMAX

Tip size: Ø 16 mm
Width: 20 mm
Length: 18 mm
Number of tips: 1



REF 138TA6225

Type: KALMAR-CLIMAX

Tip size: Ø 16 mm
Width: 20 mm
Length: 88 mm
Number of tips: 2



REF 138TA6171

Type: KALMAR-CLIMAX

Tip size: Ø 22 mm
Width: 22 mm
Length: 82,6 mm
Number of tips: 1



REF 122TA7616

Type: KALMAR-CLIMAX

Tip size: Ø 22,2 mm
Length: 19 mm
Number of tips: 1



REF 138TA6152

Type: LANSING

Tip size: 15,6 X 18,2 mm
Length: 54 mm
Number of tips: 1



REF 138TA5952

Type: LANSING

Tip size: 15,5 X 19 mm
Length: 58 mm
Number of tips: 1



REF 110TA2988

Type: LANSING

Tip size: 9,2 X 20 mm
Width: 9,5 mm
Length: 38,5 mm
Number of tips: 1



REF 138TA5950



used for: OTHER MAKES

Type: LANSING

Tip size: 13,2 X 13,2 mm
Width: 14,4 mm
Length: 125 mm
Number of tips: 1



REF 138TA6309

Type: LANSING

Tip size: 18 X 19 mm
Width: 19 mm
Length: 28,7 mm
Number of tips: 1



REF 138TA5951

Type: LANSING

Tip size: 15,8 X 18,8 mm
Width: 19 mm
Length: 33,3 mm
Number of tips: 1



REF 138TA5949

Type: LANSING

Tip size: 19,2 X 25,5 mm
Width: 19,2 mm
Length: 25,5 mm
Number of tips: 1

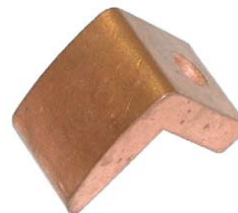

REF 138TA6174

Type: LANSING

Tip size: Ø 6,2 mm
Width: 19 mm
Length: 109 mm
Number of tips: 2



REF 138TA6308

Type: LANSING

Tip size: Ø 6,4 mm
Width: 14,3 mm
Length: 122 mm
Number of tips: 1



REF 138TA6346

Type: LANSING

Tip size: Ø 8 mm
Width: 14,2 mm
Length: 98,7 mm
Number of tips: 2



REF 132TA2560

Type: LANSING

Tip size: Ø 8 mm
Width: 19 mm
Length: 104,5 mm
Number of tips: 2



REF 132TA2559

Type: LANSING

Tip size: Ø 8 mm
Width: 19 mm
Length: 109,4 mm
Number of tips: 1



REF 132TA2561

Type: LANSING

Tip size: Ø 8 mm
Width: 19 mm
Length: 109,4 mm
Number of tips: 3



REF 132TA2562

Type: LANSING

Tip size: Ø 8 mm
Width: 19,3 mm
Length: 71 mm
Number of tips: 2



REF 138TA6350

Type: LANSING

Tip size: Ø 15,8 mm
Width: 22,4 mm
Length: 86 mm
Number of tips: 1



REF 138TA5954

Type: LANSING

Tip size: Ø 16 mm
Length: 57,5 mm
Number of tips: 1



REF 138TA6249

Type: LANSING

Tip size: Ø 16 mm
Width: 22 mm
Length: 86,3 mm
Number of tips: 1



REF 138TA5955



CONTACTS

For all our latest catalogue updates and company info: www.tvh.com

used for: **OTHER MAKES**

Type: SEVCON-200A

Tip size: Ø 15,7 mm
Width: 16 mm
Length: 43,5 mm
Number of tips: 1



REF 122TA7645

Type: UNELEC

Tip size: 19 X 20 mm
Width: 20 mm
Length: 34,5 mm
Number of tips: 1



REF 138TA5862

Type: UNELEC

Tip size: 16,5 X 19 mm
Width: 20 mm
Length: 105,8 mm
Number of tips: 1



REF 138TA5861

Type: UNELEC-CIC1

Tip size: 11 X 11 mm
Width: 16 mm
Length: 36,5 mm
Number of tips: 1

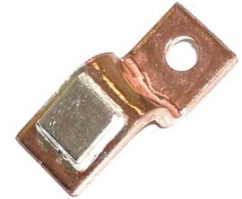

REF 138TA5929

Type: UNELEC-CIC1

Tip size: 12 X 12 mm
Width: 16 mm
Length: 39 mm
Number of tips: 1

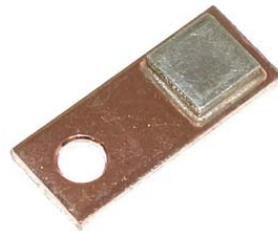

REF 138TA5932

Type: UNELEC-CIC1

Tip size: 10,1 X 11,5 mm
Width: 16,1 mm
Length: 54 mm
Number of tips: 1



REF 109TA8301

Type: UNELEC-CIC1

Tip size: 11,6 X 19,6 mm
Width: 20 mm
Length: 41,7 mm
Number of tips: 1



REF 138TA5940

Type: UNELEC-CIC1-DS

Tip size: 12 X 12 mm
Width: 16,3 mm
Length: 60 mm
Number of tips: 1

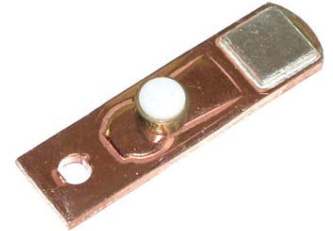

REF 138TA5942

Type: UNELEC-CIC1-RS

Tip size: 11 X 11 mm
Width: 15,6 mm
Length: 54 mm
Number of tips: 1



REF 138TA5913

Type: UNELEC-CIC1-RS

Tip size: 10,7 X 10,7 mm
Width: 16 mm
Length: 60 mm
Number of tips: 2



REF 138TA5912

Type: UNELEC-CIC1181

Tip size: 19,5 X 19,5 mm
Width: 20 mm
Length: 53,4 mm
Number of tips: 1



REF 138TA5937

Type: UNELEC-CIC1181

Tip size: 18,4 X 18,7 mm
Width: 20 mm
Length: 106,5 mm
Number of tips: 1



REF 138TA5822

Type: UNELEC-CIC1183

Tip size: 16 X 19 mm
Width: 19 mm
Length: 106,5 mm
Number of tips: 1



REF 138TA6088

Type: UNELEC-CIC1183

Tip size: 16 X 19 mm
Width: 19,2 mm
Length: 44 mm
Number of tips: 1



REF 138TA5934



used for: OTHER MAKES

Type: UNELEC-CIC1183

Tip size: 11,5 X 20,2 mm
Width: 20 mm
Length: 90 mm
Number of tips: 1



REF 108TA5898

Type: UNELEC-CIC1183

Tip size: 19,2 X 19,2 mm
Width: 20 mm
Length: 96 mm
Number of tips: 2



REF 138TA5933

Type: UNELEC-CIC2

Tip size: 15 X 20 mm
Width: 20 mm
Length: 47 mm
Number of tips: 1



REF 138TA5895

Type: UNELEC-CIC2-DS

Tip size: 15 X 19,5 mm
Width: 20 mm
Length: 75,5 mm
Number of tips: 2



REF 138TA5908

Type: UNELEC-CIC2-RS

Tip size: 15 X 20 mm
Width: 20 mm
Length: 75,2 mm
Number of tips: 2



REF 138TA5853

Type: UNELEC-CIC2-RS

Tip size: 16 X 20 mm
Width: 20,2 mm
Length: 64,2 mm
Number of tips: 1



REF 138TA5863

Type: UNELEC-IC2800

Tip size: Ø 15,5 mm
Width: 16 mm
Length: 19,4 mm
Number of tips: 1



REF 138TA5993

Type: UNELEC-IC2800

Tip size: Ø 15,5 mm
Width: 16 mm
Length: 44 mm
Number of tips: 1



REF 138TA5995

Type: UNELEC-IC2800

Tip size: Ø 15,5 mm
Width: 16 mm
Length: 68 mm
Number of tips: 1



REF 138TA5921

Type: UNELEC-IC2800

Tip size: Ø 16,2 mm
Width: 16 mm
Length: 67 mm
Number of tips: 2



REF 138TA5994

Type: YALE

Tip size: 13,5 X 24,2 mm
Width: 25 mm
Length: 89 mm
Number of tips: 1



REF 132TA2543

Look up
these parts via

PS ProductSearch

CONTACT KITS

For all our latest catalogue updates and company info: www.tvh.com

used for: **OTHER MAKES**

Type: **BALCANCAR-KPE4**
Tip size: \varnothing 10 mm



REF 123TA5758

Type: **BALCANCAR-KPE5**
Tip size: \varnothing 12 mm



REF 123TA5759

Type: **BALCANCAR-KPE6**
Tip size: \varnothing 14 mm



REF 123TA5760

Type: **CLARK - CO**
Tip size: \varnothing 16 mm



REF 133TA6473

Type: **CLARK - NO**
Tip size: \varnothing 16 mm



REF 133TA6556

Type: **JOHN MORRIS - NO**
Tip size: \varnothing 16 mm



REF 133TA3398

Type: **MAC 15 D**
Tip size: \varnothing 7,8 mm



REF 132TA3327

Type: **MAC15R**
Tip size: \varnothing 8,2 mm



REF 122TA7677



used for: OTHER MAKES

Type: SEVCON - 200A-CO
Tip size: Ø 14,7 mm

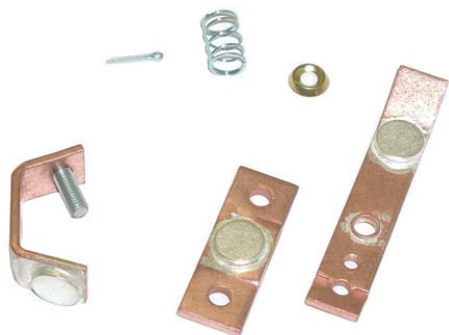

REF 138TA6503

Type: SEVCON - 200A-CO
Tip size: Ø 14,7 mm

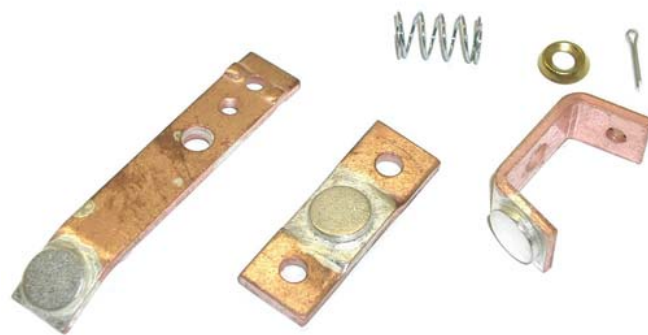

REF 133TA4538

Type: SEVCON - 200A-NO
Tip size: Ø 14,7 mm

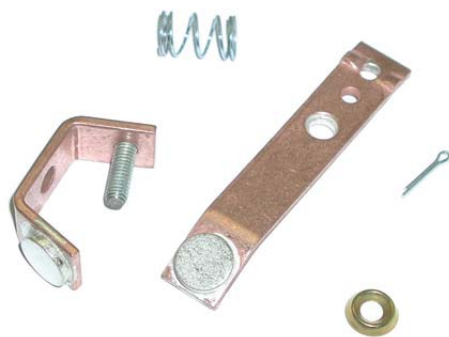

REF 133TA5441

Type: SEVCON - 200A-NO
Tip size: Ø 14,7 mm

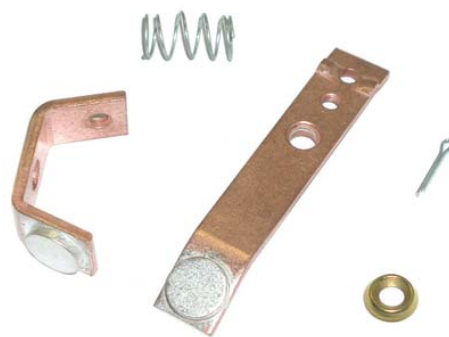

REF 133TA4863

Type: SEVCON - 300A-CO
Tip size: Ø 19 mm



REF 132TA3142

Type: SEVCON - 300A-NO
Tip size: Ø 19 mm



REF 133TA4568

Type: UNELEC
Tip size: 16 X 19 mm



REF 133TA4511

Type: UNELEC
Tip size: 16 X 19 mm



REF 133TA4886

CONTACT KITS

For all our latest catalogue updates and company info: www.tvh.com

used for: **OTHER MAKES**

Type: UNELEC
Tip size: Ø 15,8 mm



REF 133TA3794

Type: UNELEC - CIC1-DS
Tip size: 12 X 12 mm



REF 108TA7957

Type: UNELEC - CIC1-DS
Tip size: 12 X 12 mm

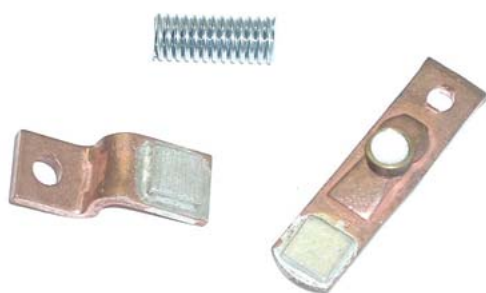

REF 133TA3914

Type: UNELEC - CIC1-RS
Tip size: 12 X 12 mm

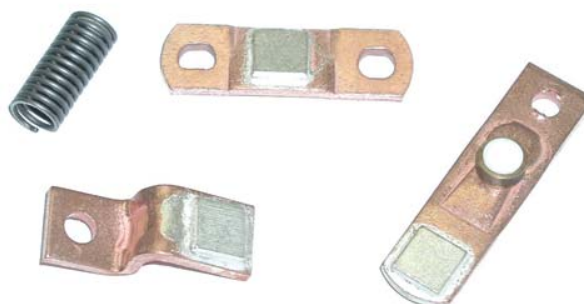

REF 133TA3882

Type: UNELEC - CIC1-RS
Tip size: 12 X 12 mm

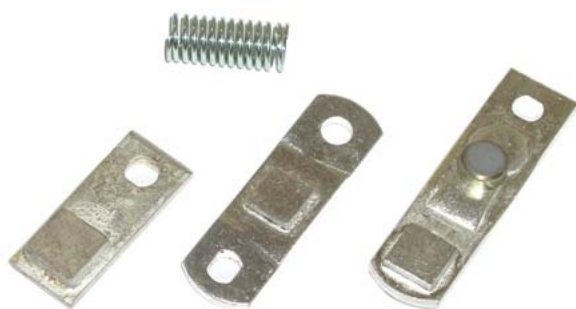

REF 108TA7926

Type: UNELEC - CIC2-RS
Tip size: 15 X 20 mm

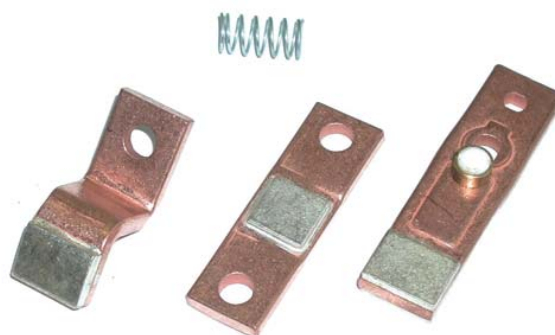

REF 132TA3222

Type: UNELEC-CIC1183
Tip size: 16 X 19 mm



REF 133TA7668

Type: UNELEC-CIC2-DS
Tip size: 15 X 20 mm



REF 133TA6647



TOTALSOURCE[®]

Look up
these parts via

PS ProductSearch

Part: 3 EMERGENCY STOPS

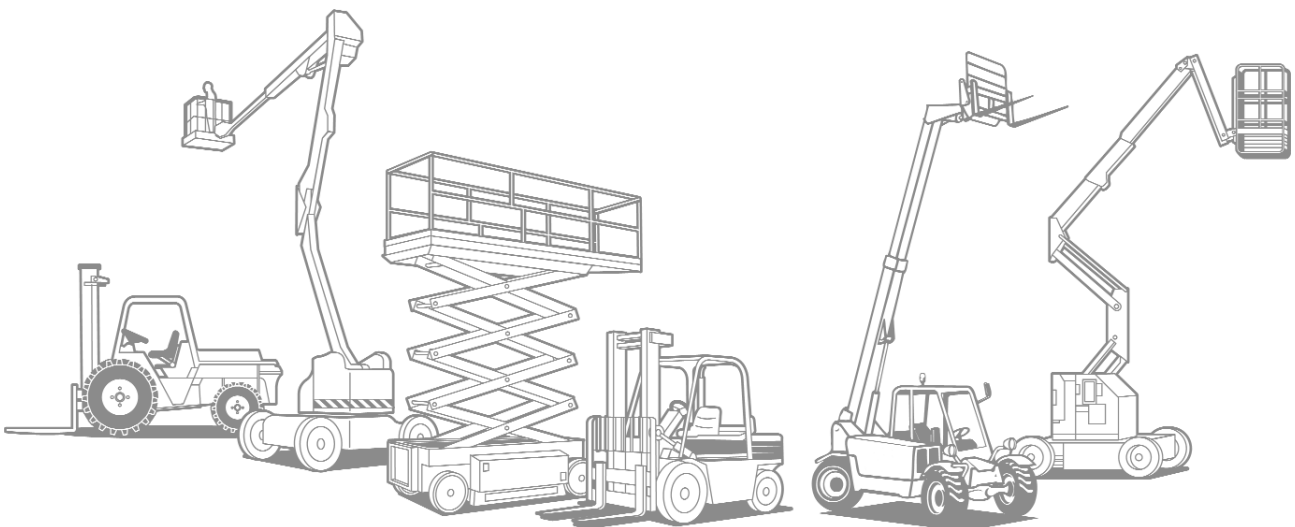



TECHNISCHE FICHE NOODSTOPSCHAKELAAR HOOG VERMOGEN

Groep
02-03-02-00

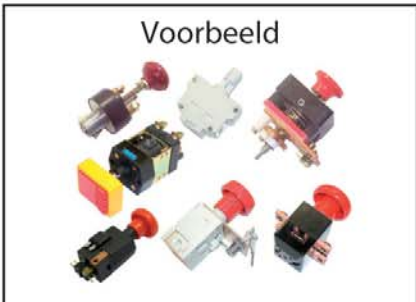

Gegevens klant

Type machine:
Serie nr. machine:

Prijsaanvraag
 Bestelling

CODE: BRAND x TYPE x I x U x KN x EX-CO x BL-OU x LO-KE x Z1 x Z2 x D1 x H1 x H2 x D2 x Z3 x Z4 x QTY-CO x D3 x C x TY-SW x DUS-COV x SI-PO x TEX-TI x ENC-COV

- ... BRAND Merk van de schakelaar.
- ... TYPE Type van de schakelaar.
- ... I Elektrische stroom (ampere).
- ... U Hoogste spanning (volt).
- ... KN Knop aanwezig: JA/NEE.
- ... EX-CO Hulpcontact aanwezig: JA/NEE.
- ... BL-OU Blaasmagneten aanwezig: JA/NEE. Indien JA, polariteit (SI-PO) invullen.
- ... LO-KE Vergrendelbaar met sleutel: JA/NEE.
- ... Z1 Maximale lengte voorzijde.
- ... Z2 Maximale lengte zijkant.
- ... D1 Diameter van de schakelaar, indien rond.
- ... H1 Totale hoogte in OFF-stand.
- ... H2 Totale hoogte in ON-stand.
- ... D2 Diameter knop, indien rond.
- ... Z3 Grootste lengte knop, indien rechthoekig.
- ... Z4 Kleinste lengte knop, indien rechthoekig.
- ... QTY-CO Totaal aantal connecties.
- ... D3 Diameter aansluitingsgaten.
- ... C Centerafstand aansluitingsgaten.



- ... TY-SW..... Contacts configuratie:
SP = enkelpolig.
DP = dubbelpolig.
- ... DUS-COV..... Stofplaat: JA/NEE.
- ... SI-PO..... Kant van polariteit:
R = rechts.
L = links.
 Enkel van toepassing als blaasmagneten aanwezig zijn (anders 0 invullen). Merklabell vooraan houden en dan ligging van de "+" bepalen (zie figuren).
- ... TEX-TI..... Textured contact: JA/NEE.
- ... ENC-COV..... Afgesloten kap: JA/NEE.

AFMETINGEN

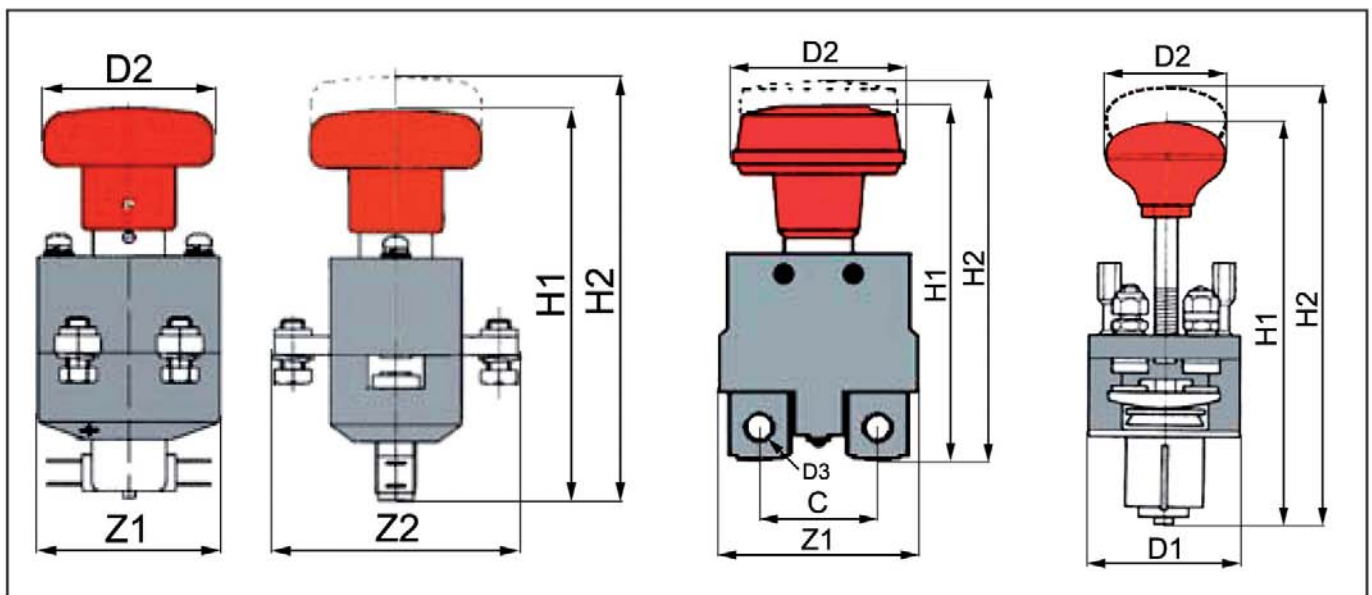

STOFPLAAT

TEXTURED CONTACT

AFGESLOTEN KAP

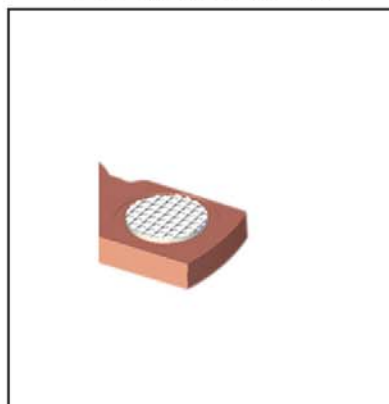



EMERGENCY STOPS

For all our latest catalogue updates and company info: www.tvh.com

KANT VAN POLARITEIT

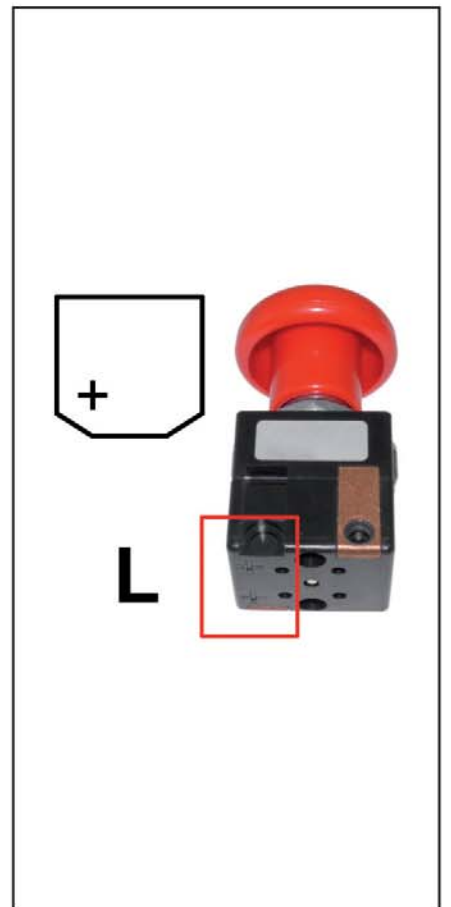
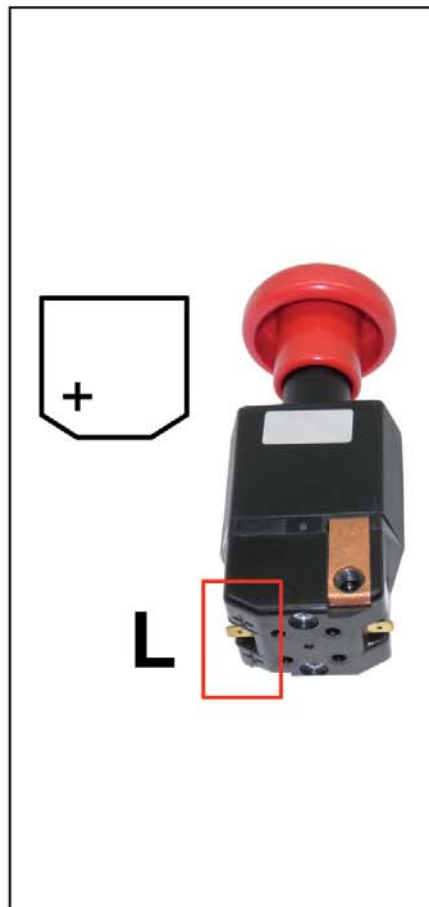
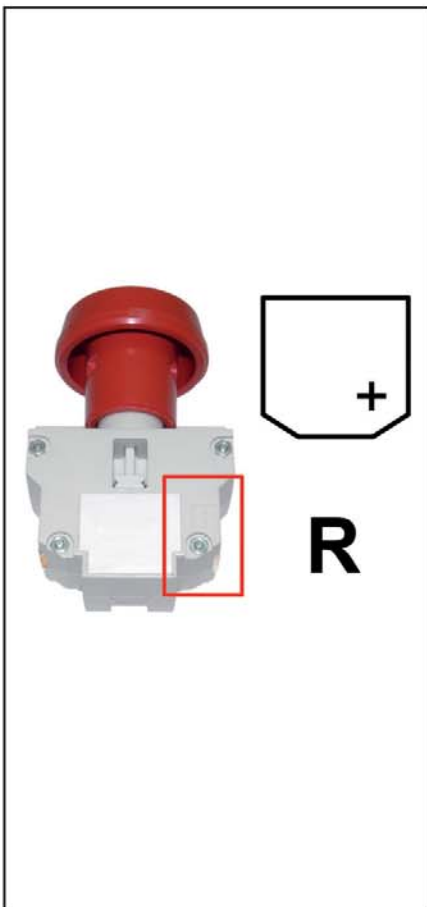
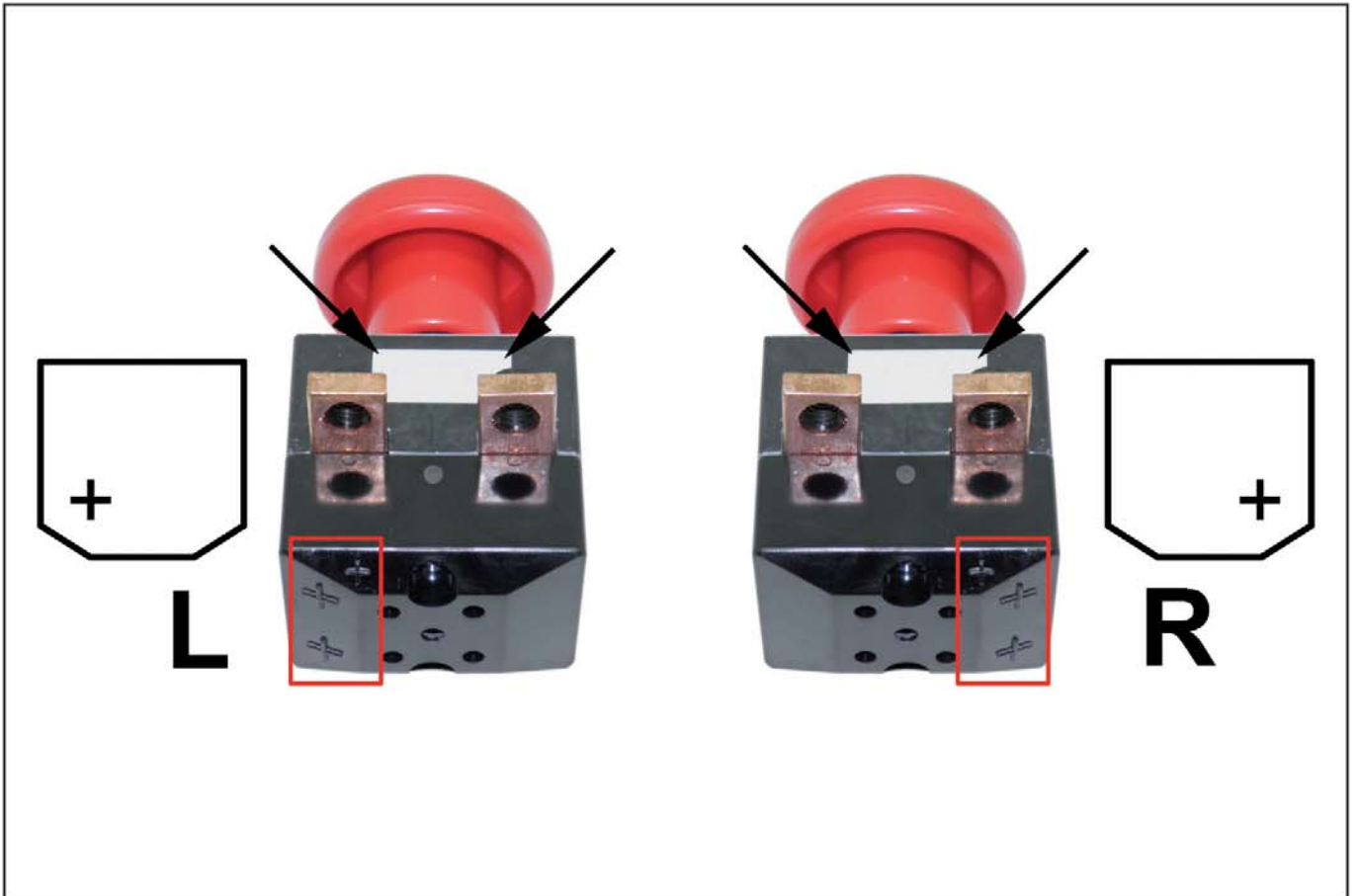



FICHE TECHNIQUE

ARRET D'URGENCE HAUTE PUISSANCE

Groupe
02-03-02-00

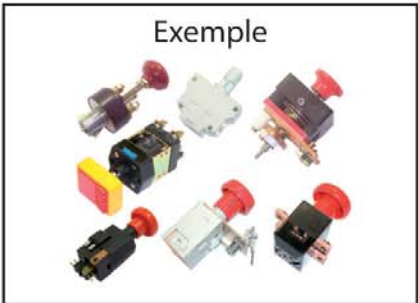

Nom de votre société

Type machine : Demande de prix
 No. série machine : Commande

CODE : BRAND x TYPE x I x U x KN x EX-CO x BL-OU x LO-KE x Z1 x Z2 x D1 x H1 x H2 x D2 x Z3 x Z4 x QTY-CO x D3 x C x TY-SW x DUS-COV x SI-PO x TEX-TI x ENC-COV

- ... BRAND Marque de l'interrupteur.
- ... TYPE Type de l'interrupteur.
- ... I..... Ampérage.
- ... U..... Tension maximale (Volt).
- ... KN Bouton présent : OUI/NON.
- ... EX-CO..... Contact auxiliaire présent : OUI/NON.
- ... BL-OU..... Aimant de soufflage présent : OUI/NON. Si OUI, indiquer côté de polarité (SI-PO).
- ... LO-KE Verrouillable à clé : OUI/NON.
- ... Z1..... Longueur maximale de la face avant.
- ... Z2..... Longueur maximale du côté.
- ... D1 Diamètre de l'interrupteur, si rond.
- ... H1 Hauteur totale en position OFF.
- ... H2 Hauteur totale en position ON.
- ... D2 Diamètre du bouton, si rond.
- ... Z3..... Plus grande longueur du bouton, si rectangle.
- ... Z4..... Plus petite longueur du bouton, si rectangle.
- ... QTY-CO Nombre de connexions.
- ... D3 Diamètre des trous de connexion.





EMERGENCY STOPS

For all our latest catalogue updates and company info: www.tvh.com

- ... C..... Entraxe des trous de connexion.
- ... TY-SW..... Configuration des contacts :
SP = unipolaire.
DP = bipolaire.
- ... DUS-COV..... Plaque cache poussière : OUI/NON.
- ... SI-PO..... Côté de polarité :
R = droit.
L = gauche.
 Doit être indiqué si le contacteur est muni d'aimants de soufflage (dans le cas contraire, remplir "0"). Tenir le contacteur avec l'étiquette portant la marque devant, puis définir la position du "+" (voir figures).
- ... TEX-TI..... Pastilles de contacts texturées : OUI/NON.
- ... ENC-COV..... Couvercle fermé : OUI/NON.

DIMENSIONS

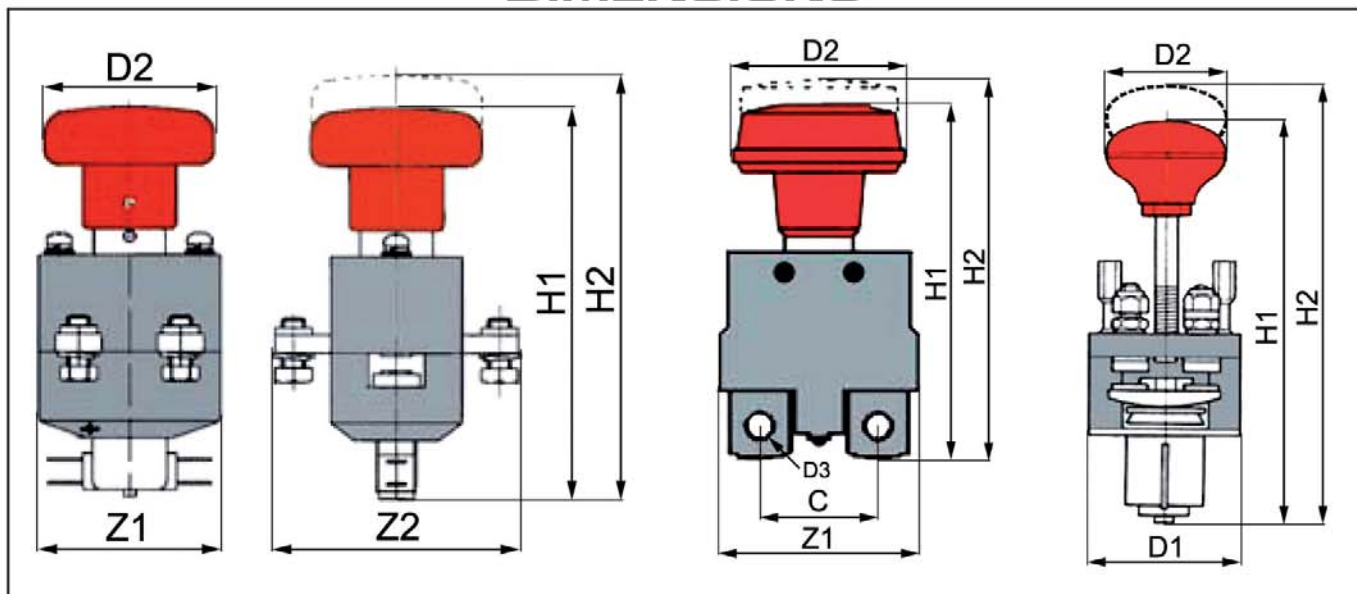

PLAQUE CACHE POUSSIÈRE



PASTILLES DE CONTACTS TEXTURÉES

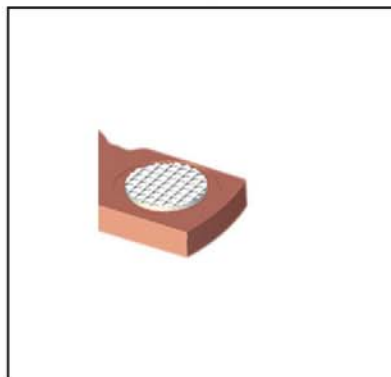

COUVERCLE FERMÉ





CÔTÉ DE POLARITÉ

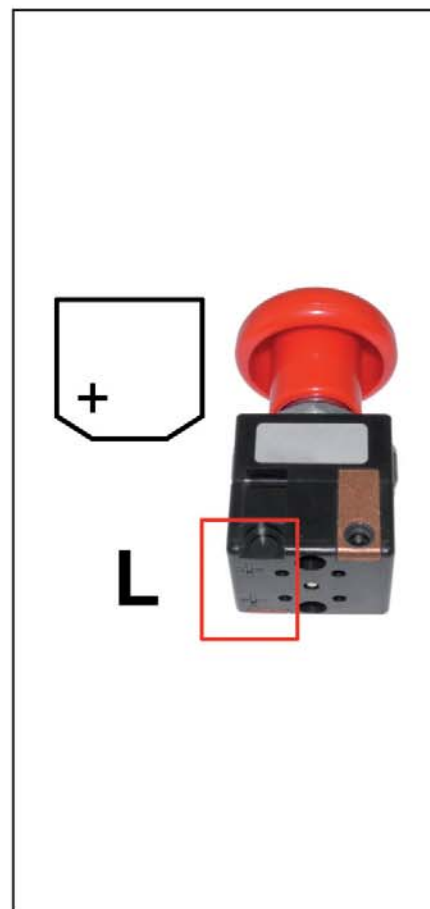
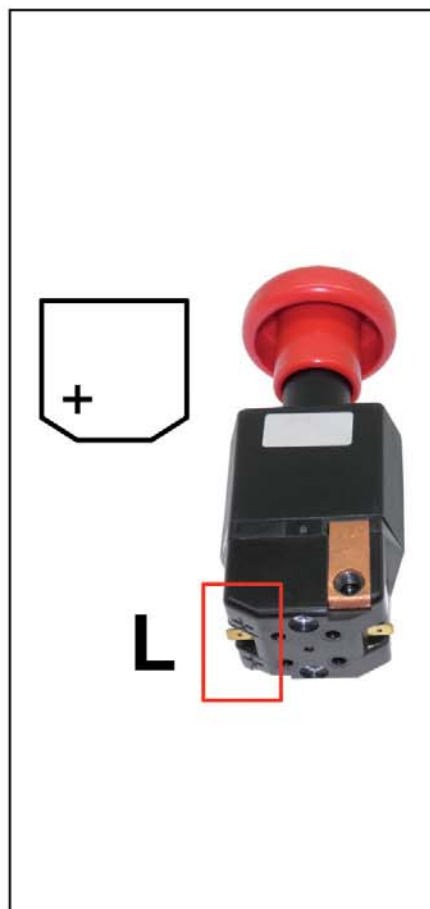
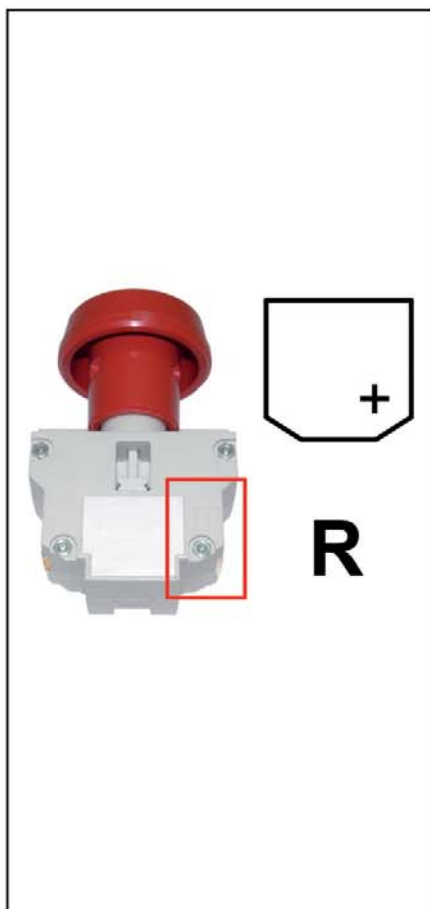
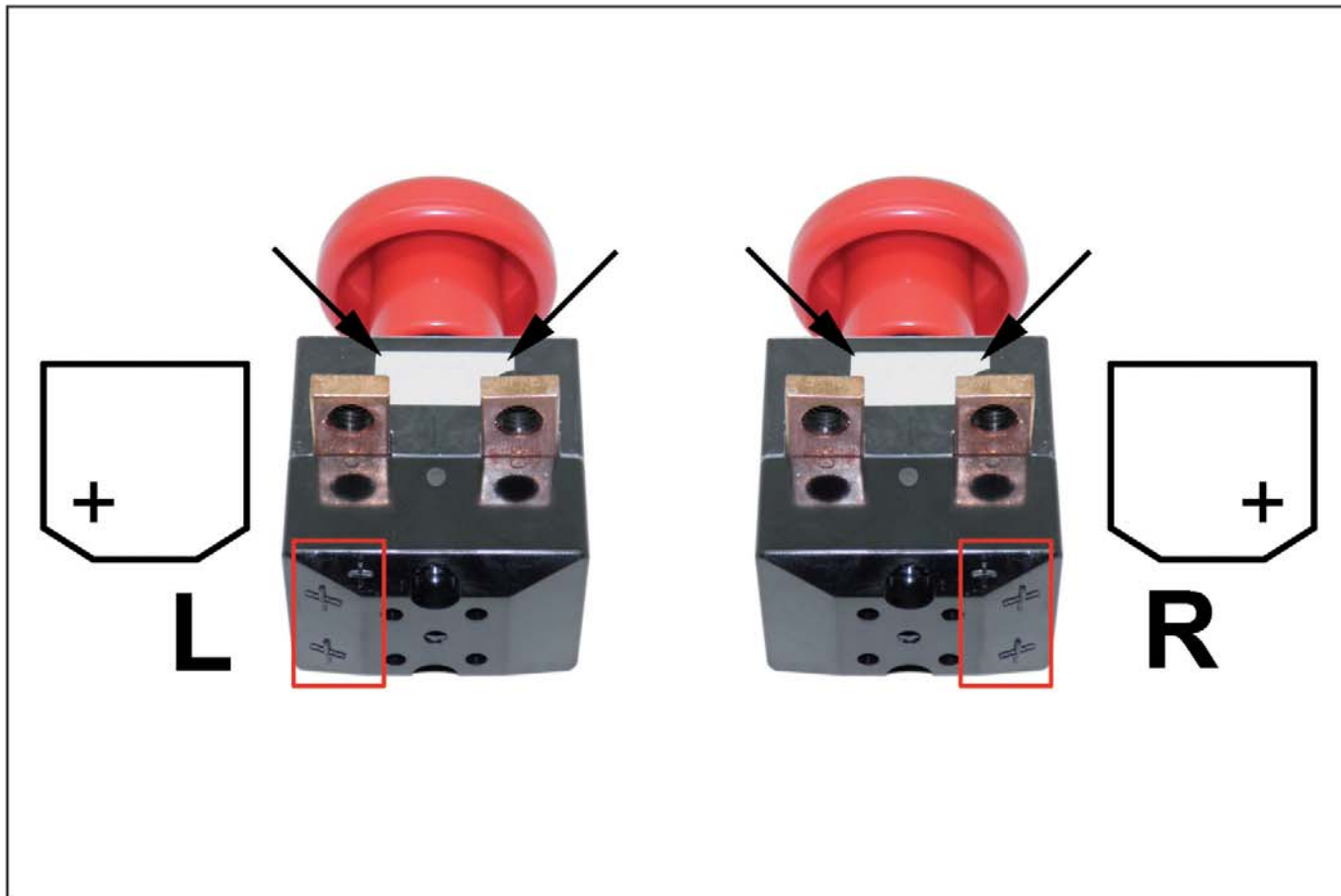



EMERGENCY STOPS

For all our latest catalogue updates and company info: www.tvh.com

TECHNICAL SHEET EMERGENCY STOP SWITCH HIGH CAPACITY

Group
02-03-02-00

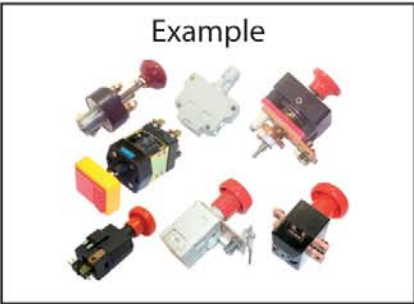

Customer details



Type machine:
Serial no. machine:

Price inquiry
 Order

CODE: BRAND x TYPE x I x U x KN x EX-CO x BL-OU x LO-KE x Z1 x Z2 x D1 x H1 x H2 x D2 x Z3 x Z4 x QTY-CO x D3 x C x TY-SW x DUS-COV x SI-PO x TEX-TI x ENC-COV

...
...
...
...
...
...
...
...
...
...
...
...
...
...
...
...
...
...
...
...
...
...
...

- BRAND Brand of the switch.
- TYPE Type of the switch.
- I..... Current (Ampere).
- U..... Highest tension (Volt).
- KN Knob present: YES/NO.
- EX-CO..... Auxilliary switch present: YES/NO.
- BL-OU..... Blow out present: YES/NO. If YES, fill out (SI-PO) side polarity.
- LO-KE Lockable with key: YES/NO.
- Z1..... Maximal length frontal side.
- Z2..... Maximal length side side.
- D1 Diameter of the switch, if square.
- H1 Total height in OFF-position.
- H2 Total height in ON-position.
- D2 Diameter of the knob, if round.
- Z3..... Biggest side of the knob, if square.
- Z4..... Smallest side of the knob, if square.
- QTY-CO Quantity of connections.
- D3 Diameter of the wire connection holes.
- C..... Center distance between wire connection holes.



- ... TY-SW..... Contacts configuration:
SP = single pole.
DP = double pole.

- ... DUS-COV..... Dust cover YES/NO.

- ... SI-PO..... Side of polarity:
R = right.
L = left.
 Only to be filled out if blow out present (if not fill out 0). Hold with the label with brand to the front and then determine the position of the '+' pole (see drawings).

- ... TEX-TI..... Textured tips: YES/NO.

- ... ENC-COV..... Enclosed cover: YES/NO.

DIMENSIONS

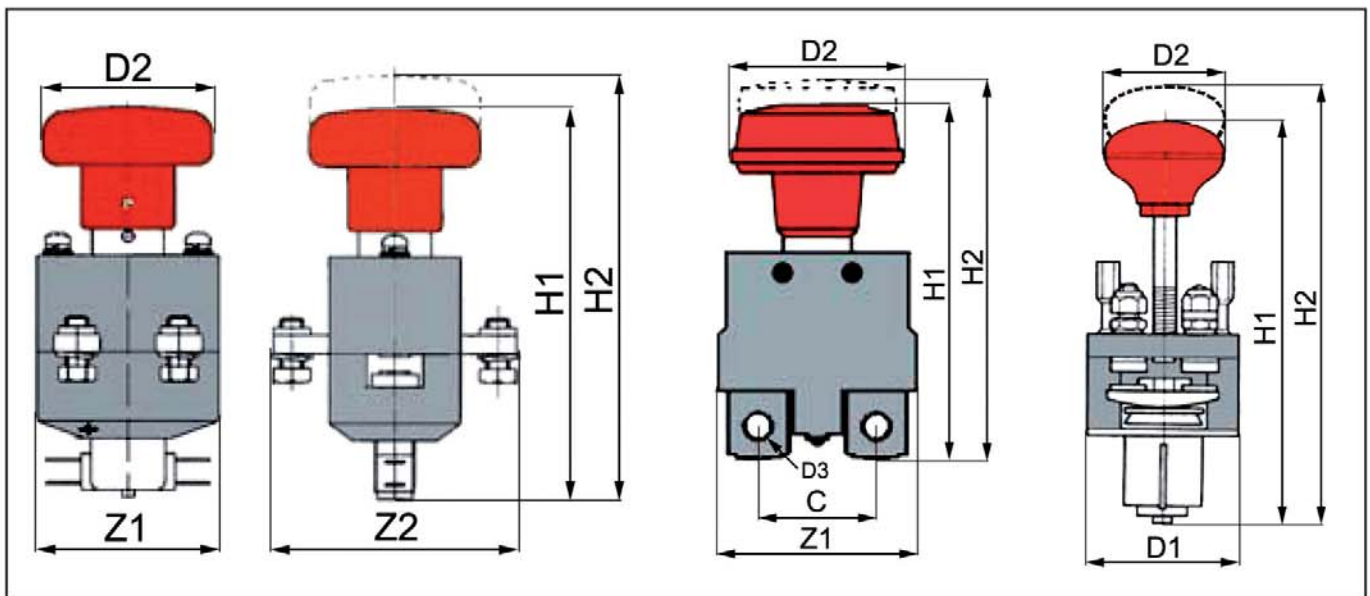

DUST COVER

TEXTURED TIPS

ENCLOSED COVER

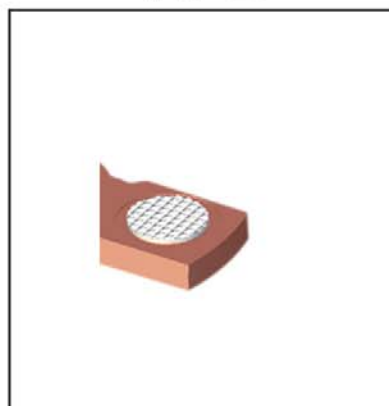



EMERGENCY STOPS

For all our latest catalogue updates and company info: www.tvh.com

SIDE OF POLARITY

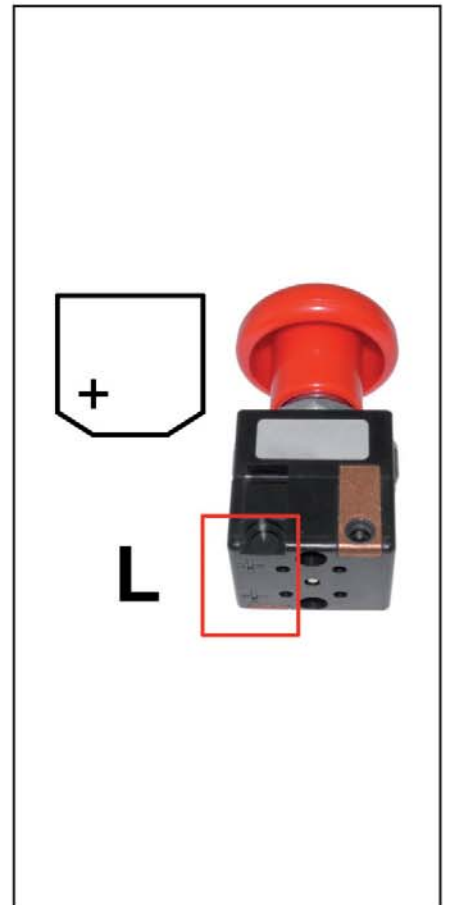
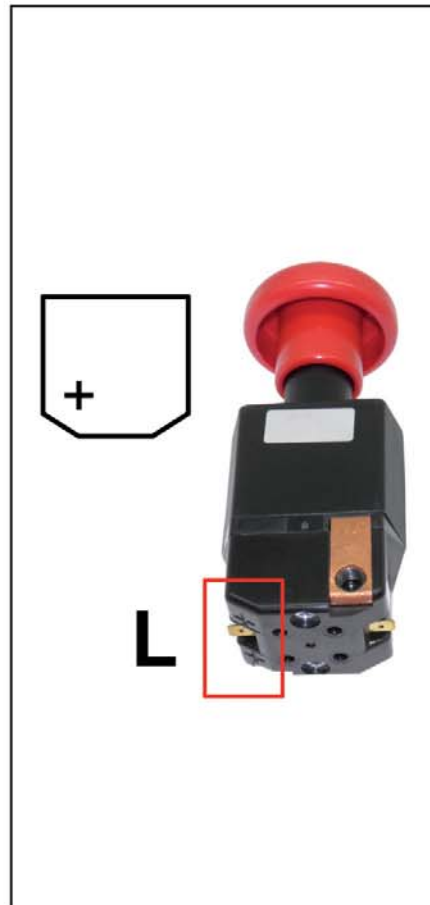
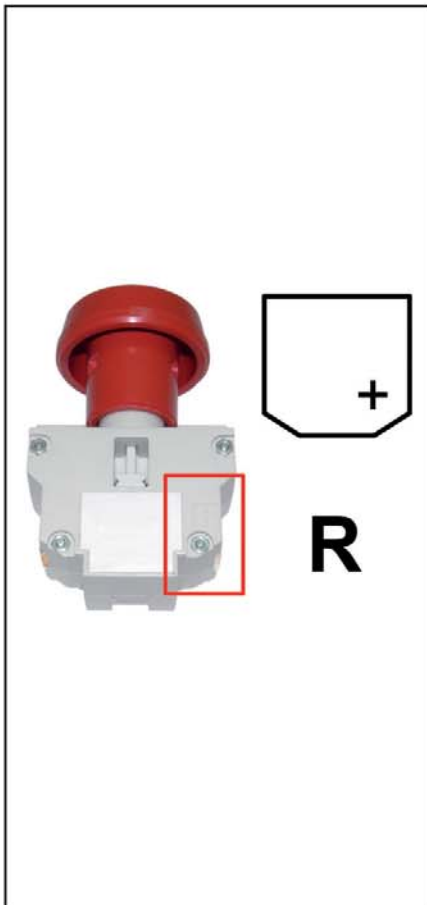
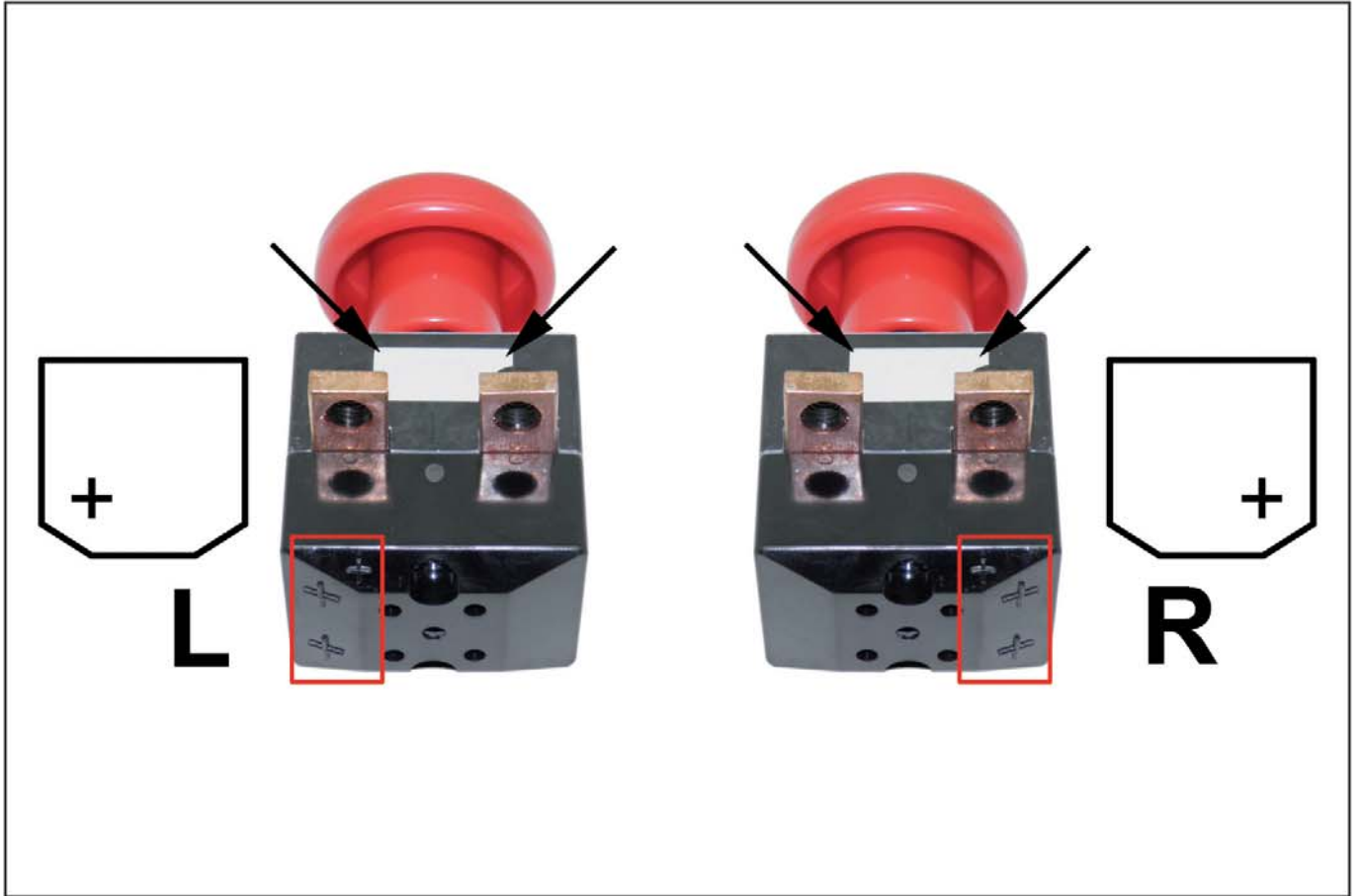



TECHNISCHES DATENBLATT NOTSTOPPSCHALTER HOHE LEISTUNG

Gruppe
02-03-02-00



Beispiel



Kundendaten

Maschinentyp: Preisanfrage
 Serienr.maschine: Bestellung

CODE: BRAND x TYPE x I x U x KN x EX-CO x BL-OU x LO-KE x Z1 x Z2 x D1 x H1 x H2 x D2 x Z3 x Z4 x QTY-CO x D3 x C x TY-SW x DUS-COV x SI-PO x TEX-TI x ENC-COV

- ... BRAND Marke von dem Schalter.
- ... TYPE Schaltertyp.
- ... I Elektrischer Strom (Ampere).
- ... U Höchste Spannung (Volt).
- ... KN Knopf anwesend: JA/NEIN.
- ... EX-CO Hilfskontakte anwesend: JA/NEIN.
- ... BL-OU Blasmagneten anwesend: JA/NEIN. Wenn ja, bitte Polarität (SI-PO) angeben.
- ... LO-KE Abschließbar mit Schlüssel: JA/NEIN.
- ... Z1 Maximale Länge Vorderseite.
- ... Z2 Maximale Seitenlänge.
- ... D1 Durchmesser von dem Schalter, wenn rund.
- ... H1 Gesamthöhe im OFF-Stand.
- ... H2 Gesamthöhe im ON-Stand.
- ... D2 Knopfdurchmesser, wenn rund.
- ... Z3 Größte Knopflänge, wenn rechteckig.
- ... Z4 Kleinste Knopflänge, wenn rechteckig.
- ... QTY-CO Gesamtanzahl Anschlüsse.
- ... D3 Durchmesser Anschlußlöcher.



EMERGENCY STOPS

For all our latest catalogue updates and company info: www.tvh.com

- ... C..... Lochabstand Anschlußlöcher.
- ... TY-SW..... Polarität:
 SP = einpolig.
 DP = doppeltpolig.
- ... DUS-COV Staubplatte: JA/NEIN.
- ... SI-PO..... Seite Polarität:
 R = rechts.
 L = links.
 Nur verwendet wenn ein Blasmagnet anwesend ist (anders 0 ausfüllen).
 Markenetiket nach vorne halten und dann die Lage von dem "+"
 bestimmen (siehe Figur).
- ... TEX-TI..... Textured tips: JA/NEIN.
- ... ENC-COV Geschlossene Haube: JA/NEIN.

ABMESSUNGEN

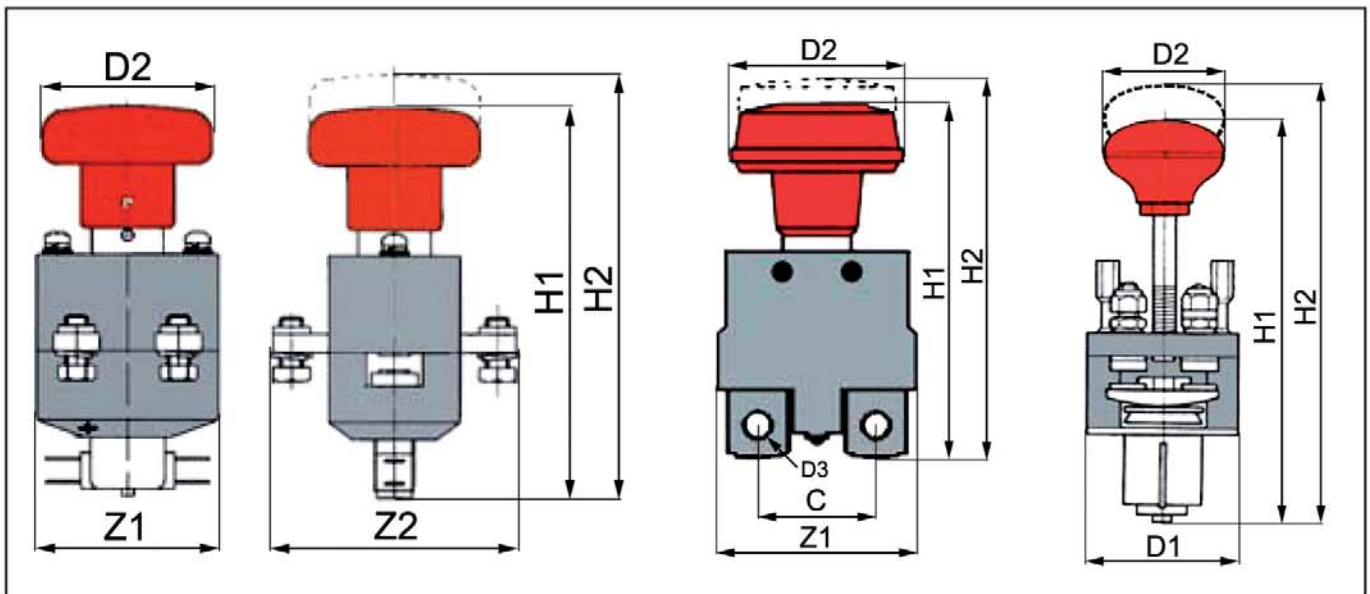

STAUBPLATTE



TEXTURED CONTACT

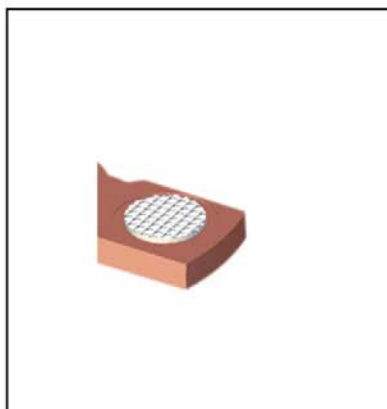

GESCHLOSSENE HAUBE





SEITE POLARITÄT

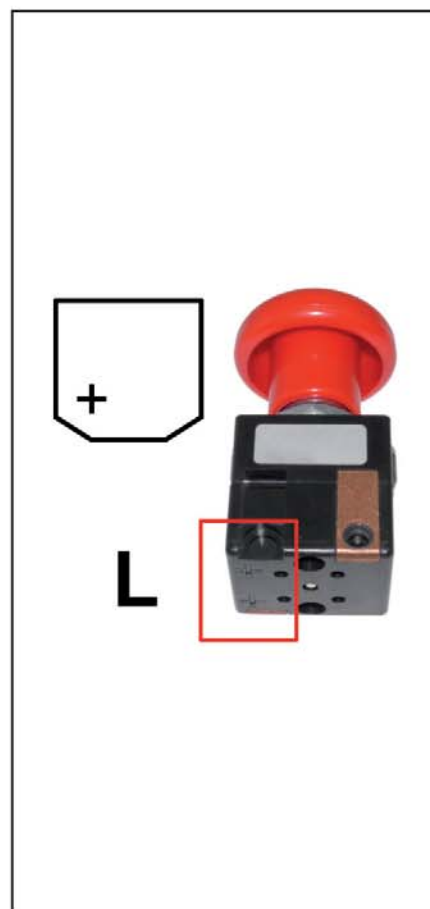
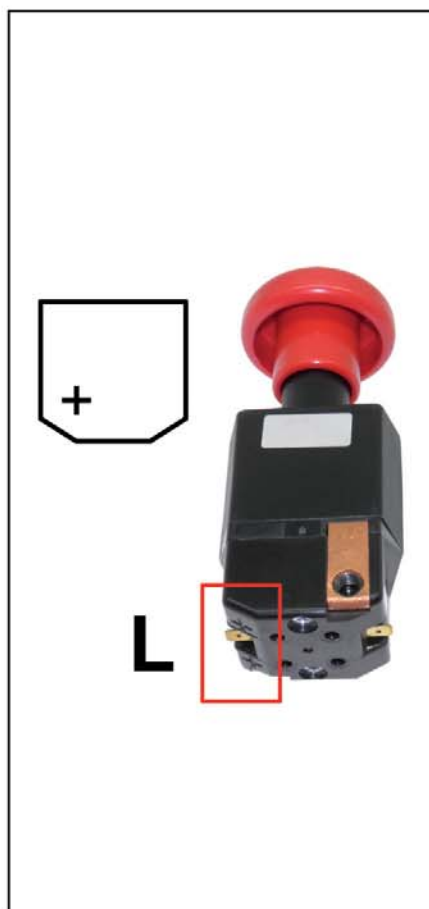
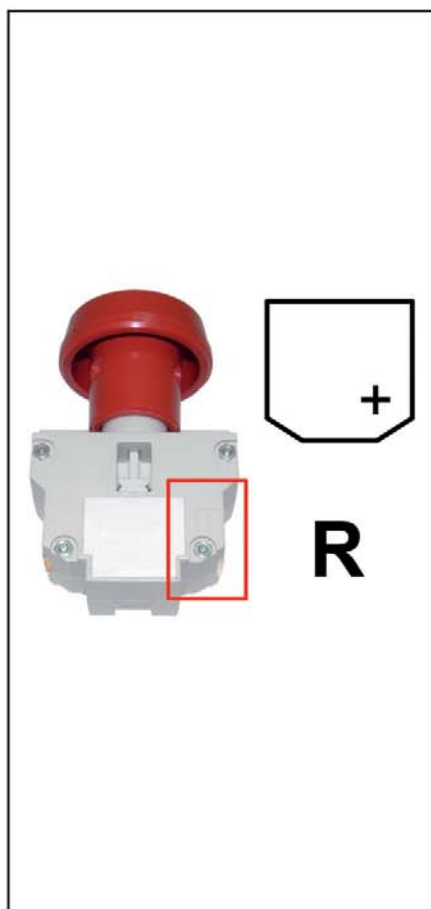
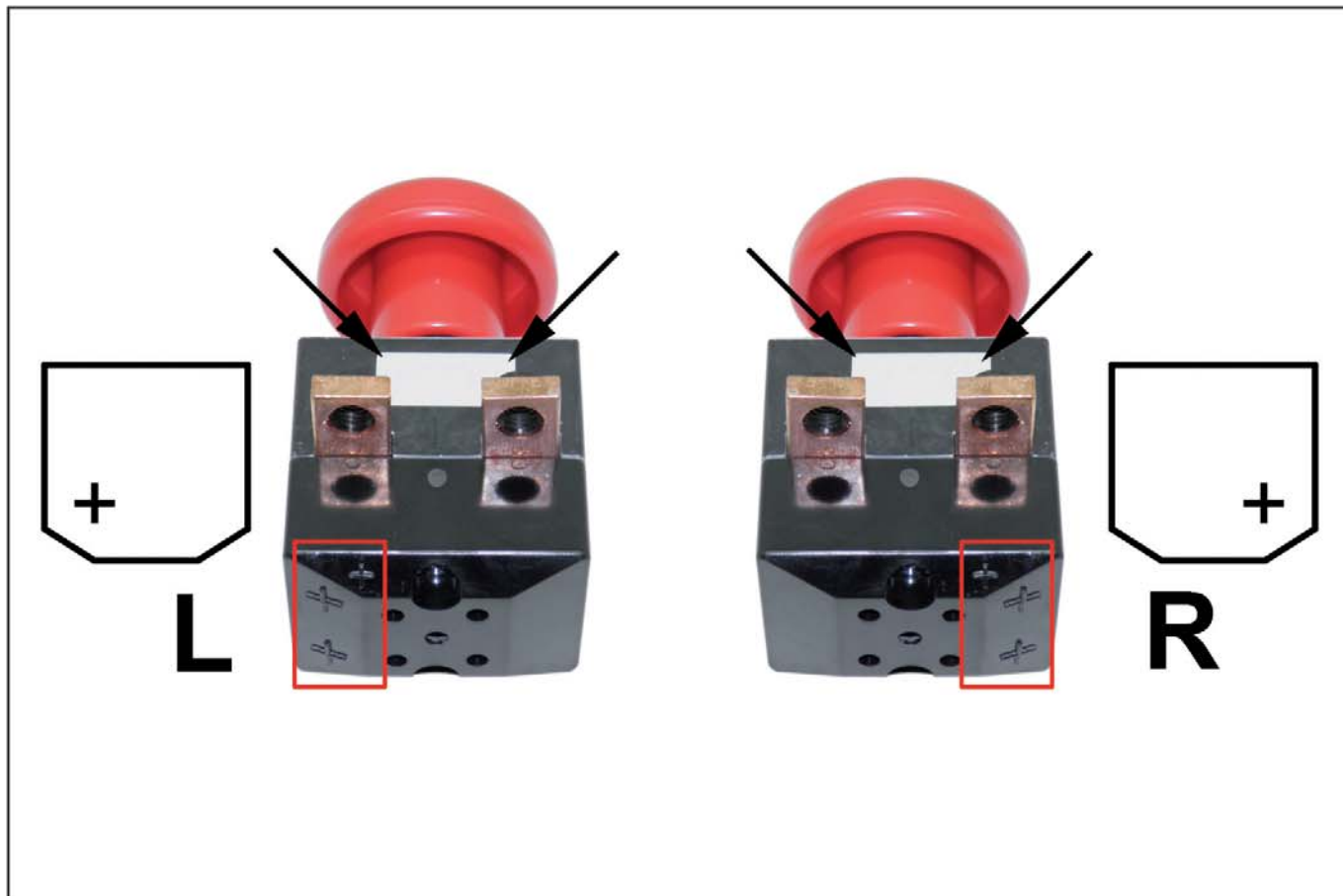



EMERGENCY STOPS

For all our latest catalogue updates and company info: www.tvh.com

used for: ALBRIGHT - ED125 - SINGLE POLE - 125A

48 V max.



max. height in OFF: 105 mm
max. height in ON: 110 mm

REF [139TA2589](#)

48 V max.

with 2 extra holes
at 90 degrees to
normal holes fitted



max. height in OFF: 100 mm
max. height in ON: 107 mm

REF [139TA2597](#)

48 V max.

with dust covers



max. height in OFF: 100 mm
max. height in ON: 107 mm

REF [139TA2595](#)

48 V max.

with dust covers



max. height in OFF: 100 mm
max. height in ON: 107 mm

REF [139TA2591](#)

48 V max.



max. height in OFF: 105 mm
max. height in ON: 110 mm

REF [139TA2594](#)

48 V max.

with dust covers



max. height in OFF: 92 mm
max. height in ON: 96 mm

REF [139TA2593](#)

48 V max.



max. height in OFF: 100 mm
max. height in ON: 107 mm

REF [139TA2596](#)

48 V max.

with dust covers
with rubber plug
fitted



max. height in OFF: 90 mm
max. height in ON: 96 mm

REF [139TA2588](#)

48 V max.

with dust covers



max. height in OFF: 90 mm
max. height in ON: 96 mm

REF [139TA2598](#)

48 V max.

with dust covers
textured tips



max. height in OFF: 90 mm
max. height in ON: 96 mm

REF [139TA2590](#)

48 V max.



max. height in OFF: 94 mm
max. height in ON: 100 mm

REF [139TA2592](#)

used for: ALBRIGHT - ED125A - SINGLE POLE - 125A

48 V max.



max. height in OFF: 122 mm
max. height in ON: 128 mm

REF [139TA2599](#)

48 V max.



max. height in OFF: 130 mm
max. height in ON: 136 mm

REF [139TA2600](#)

48 V max.

with dust covers



max. height in OFF: 117 mm
max. height in ON: 123 mm

REF [139TA2601](#)

O.E.M. references are purely indicative and do not imply that parts originate from the original manufacturer.

EMERGENCY STOPS



For all our latest catalogue updates and company info: www.tvh.com

used for: **ALBRIGHT - ED250 - SINGLE POLE - 250A**

48 V max.



max. height in OFF: 114 mm
max. height in ON: 125 mm

REF 139TA2602

48 V max.



enclosed cover

max. height in OFF: 114 mm
max. height in ON: 125 mm

REF 139TA2607

48 V max.



max. height in OFF: 114 mm
max. height in ON: 125 mm

REF 139TA2608

48 V max.



with dust covers

max. height in OFF: 114 mm
max. height in ON: 125 mm

REF 139TA2604

48 V max.



enclosed cover

max. height in OFF: 114 mm
max. height in ON: 125 mm

REF 139TA2603

48 V max.



max. height in OFF: 121 mm
max. height in ON: 132 mm

REF 139TA2606

48 V max.



with blowouts

max. height in OFF: 130 mm
max. height in ON: 140 mm

REF 139TA2605



96 V max.



with blowouts

max. height in OFF: 141 mm
max. height in ON: 152 mm

REF 139TA2610



96 V max.



with blowouts

enclosed cover

max. height in OFF: 114 mm
max. height in ON: 125 mm

REF 139TA2609



96 V max.



with blowouts
enclosed cover

with O-ring on shaft

max. height in OFF: 114 mm
max. height in ON: 125 mm

REF 139TA2612



96 V max.



with blowouts

max. height in OFF: 125 mm
max. height in ON: 135 mm

REF 139TA2613



96 V max.



with blowouts

max. height in OFF: 114 mm
max. height in ON: 123 mm

REF 139TA2611



96 V max.



with blowouts

max. height in OFF: 114 mm
max. height in ON: 125 mm

REF 139TA2614



Look up
these parts via

PS ProductSearch



EMERGENCY STOPS

For all our latest catalogue updates and company info: www.tvh.com

used for: ALBRIGHT - ED250A - SINGLE POLE - 250A

48 V max.

type-2



max. height in OFF: 135 mm
max. height in ON: 145 mm

REF [139TA2616](#)

48 V max.

type-64



max. height in OFF: 135 mm
max. height in ON: 145 mm

REF [139TA2615](#)

96 V max.

with blowouts



max. height in OFF: 135 mm
max. height in ON: 145 mm

REF [139TA2619](#)



96 V max.

with blowouts

enclosed cover



max. height in OFF: 135 mm
max. height in ON: 145 mm

REF [139TA2617](#)



96 V max.

with blowouts

aux contact must
operate before main
contact opens



max. height in OFF: 135 mm
max. height in ON: 145 mm

REF [139TA2620](#)



96 V max.

with blowouts

enclosed cover



max. height in OFF: 111 mm
max. height in ON: 122 mm

REF [139TA2621](#)



96 V max.

with blowouts

enclosed cover



max. height in OFF: 135 mm
max. height in ON: 145 mm

REF [139TA2618](#)



used for: ALBRIGHT - ED252 - DOUBLE POLE - 250A

96 V max.



max. height in OFF: 114 mm
max. height in ON: 125 mm

REF [139TA2622](#)

96 V max.



max. height in OFF: 114 mm
max. height in ON: 125 mm

REF [139TA2624](#)

96 V max.

min. push off
pressure to be 3 lbs



max. height in OFF: 114 mm
max. height in ON: 125 mm

REF [139TA2623](#)

150 V max.

with blowouts



max. height in OFF: 114 mm
max. height in ON: 125 mm

REF [139TA2625](#)



150 V max.

with blowouts



max. height in OFF: 114 mm
max. height in ON: 125 mm

REF [139TA3237](#)



O.E.M. references are purely indicative and do not imply that parts originate from the original manufacturer.

EMERGENCY STOPS



For all our latest catalogue updates and company info: www.tvh.com

used for: ALBRIGHT - ED252A - DOUBLE POLE - 250A

96 V max.



enclosed cover

max. height in OFF: 135 mm
max. height in ON: 145 mm

REF 139TA2626

150 V max.

with blowouts



max. height in OFF: 135 mm
max. height in ON: 146 mm

REF 139TA2627



used for: ALBRIGHT - ED402 - DOUBLE POLE - 400A

96 V max.



max. height in OFF: 145 mm
max. height in ON: 155 mm

REF 139TA2629

96 V max.



max. height in OFF: 145 mm
max. height in ON: 155 mm

REF 139TA2628

used for: ALBRIGHT - SD150A - SINGLE POLE - 125A

14 V max.

with dust covers

CONT

max. height in OFF: 126 mm
max. height in ON: 133 mm

REF 139TA2630



24 V max.

CONT

max. height in OFF: 150 mm
max. height in ON: 155 mm

REF 139TA2636



24 V max.

max. height in OFF: 155 mm
max. height in ON: 161 mm

REF 139TA2639



24 V max.

max. height in OFF: 164 mm
max. height in ON: 171 mm

REF 139TA2638



24 V max.

INT

max. height in OFF: 150 mm
max. height in ON: 155 mm

REF 139TA2632



24 V max.

with contact gap 1 mm approx when knob in up position and coil de-energised
max. height in OFF: 148 mm
max. height in ON: 155 mm

REF 139TA2634



24 V max.

CONT

max. height in OFF: 150 mm
max. height in ON: 155 mm

REF 139TA2635



24 V max.

max. height in OFF: 144 mm
max. height in ON: 151 mm

REF 139TA2640



24 V max.

with standard contact gap when knob in up position and coil de-energised

max. height in OFF: 150 mm
max. height in ON: 155 mm

REF 139TA2631



O.E.M. references are purely indicative and do not imply that parts originate from the original manufacturer.



EMERGENCY STOPS

For all our latest catalogue updates and company info: www.tvh.com

24 V max.



INT

max. height in OFF: 150 mm
max. height in ON: 155 mm

REF 139TA2633

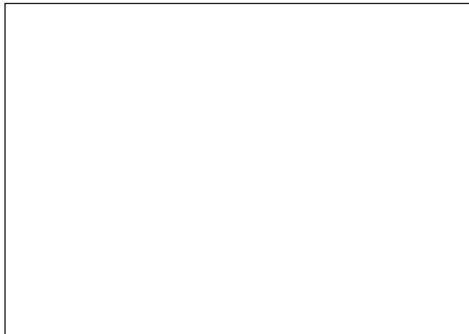
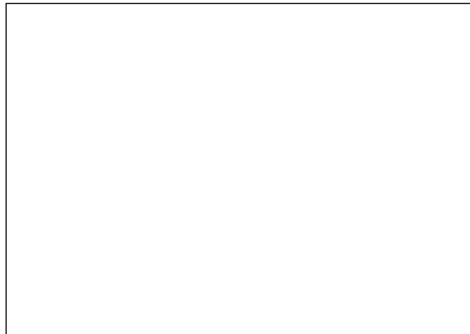

used for: **ALBRIGHT - SD200A - SINGLE POLE - 200A**

24 V max.



max. height in OFF: 145 mm
max. height in ON: 150 mm

REF 139TA2642

24 V max.



max. height in OFF: 145 mm
max. height in ON: 150 mm

REF 139TA2643

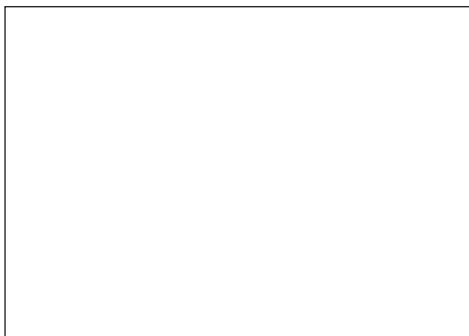

used for: **ALBRIGHT - SD250 - SINGLE POLE - 250A**

24 V max.



max. height in OFF: 168 mm
max. height in ON: 174 mm

REF 139TA2647



used for: **ALBRIGHT - SD250A - SINGLE POLE - 250A**

24 V max.
with blowouts



max. height in OFF: 147 mm
max. height in ON: 153 mm

REF 139TA2645



24 V max.
with blowouts



max. height in OFF: 136 mm
max. height in ON: 141 mm

REF 139TA2649



24 V max.



INT

max. height in OFF: 168 mm
max. height in ON: 174 mm

REF 139TA2646

24 V max.



CONT

max. height in OFF: 168 mm
max. height in ON: 174 mm

REF 139TA2644

24 V max.
with blowouts
textured tips



max. height in OFF: 136 mm
max. height in ON: 141 mm

REF 139TA2648



48 V max.
with blowouts



max. height in OFF: 168 mm
max. height in ON: 174 mm

REF 139TA2650



O.E.M. references are purely indicative and do not imply that parts originate from the original manufacturer.

EMERGENCY STOPS



For all our latest catalogue updates and company info: www.tvh.com

48 V max.
with blowouts
with dust covers



max. height in OFF: 168 mm
max. height in ON: 174 mm

REF 139TA2651



48 V max.
with blowouts



max. height in OFF: 136 mm
max. height in ON: 141 mm

REF 139TA2652



80 V max.
with blowouts



max. height in OFF: 168 mm
max. height in ON: 174 mm

REF 139TA2653



96 V max.
with blowouts
with dust covers



max. height in OFF: 141 mm
max. height in ON: 152 mm

REF 139TA2654

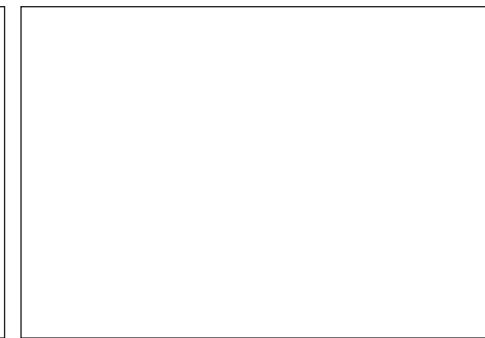
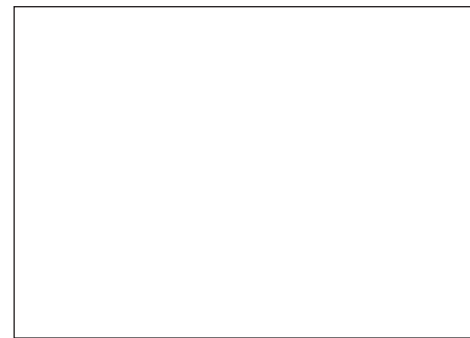
used for: **ALBRIGHT - SD300A - SINGLE POLE - 300A**

24 V max.



max. height in OFF: 172 mm
max. height in ON: 177 mm

REF 139TA2655

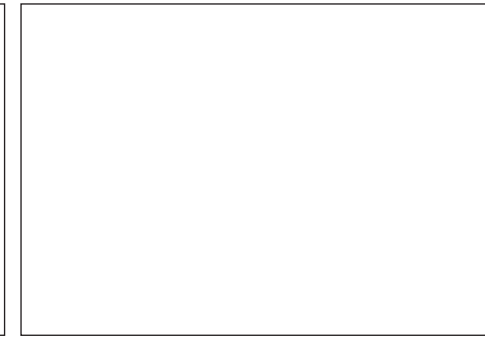
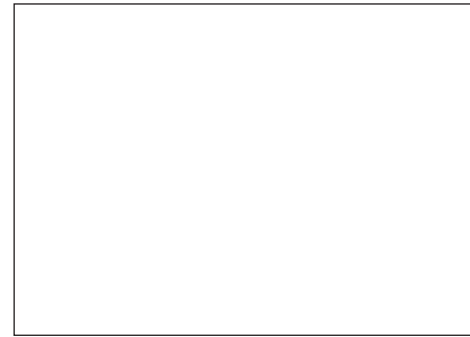

used for: **ALBRIGHT - SW155 - DOUBLE POLE - 200A**

96 V max.
1 link fitted



max. height in OFF: 155 mm
max. height in ON: 160 mm

REF 139TA2656

96 V max.



max. height in OFF: 155 mm
max. height in ON: 160 mm

REF 139TA2657



used for: **ALBRIGHT - SW159 - SINGLE POLE - 200A**

48 V max.



max. height in OFF: 163 mm
max. height in ON: 167 mm

REF 139TA2659

48 V max.



max. height in OFF: 156 mm
max. height in ON: 160 mm

REF 139TA2658

Look up these parts via



O.E.M. references are purely indicative and do not imply that parts originate from the original manufacturer.



EMERGENCY STOPS

For all our latest catalogue updates and company info: www.tvh.com

used for: **ALBRIGHT - SW203 - SINGLE POLE - 250A**

120 V max.

with blowouts

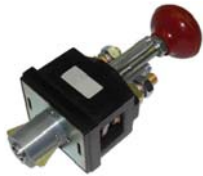

max. height in OFF: 185 mm
max. height in ON: 190 mm

REF [139TA2660](#)



used for: **ALBRIGHT - SW230 - SINGLE POLE - 250A**

120 V max.

with blowouts



max. height in OFF: 185 mm
max. height in ON: 190 mm

REF [139TA3238](#)



used for: **AMETEK - HBSP220N - SINGLE POLE - 100A**

24 V max.



max. height in OFF: 142 mm
max. height in ON: 149 mm

REF [139TA2661](#)

used for: **AMETEK - JAR4820BBKO-M - SINGLE POLE - 150A**

24 V max.



max. height in OFF: 154 mm
max. height in ON: 159 mm

REF [139TA2662](#)

24 V max.



max. height in OFF: 159 mm
max. height in ON: 164 mm

REF [139TA2663](#)

used for: **ANDERSON - 404G1 - SINGLE POLE - 350A**

36 V max.



max. height in OFF: 235 mm
max. height in ON: 257 mm

REF [139TA2664](#)

O.E.M. references are purely indicative and do not imply that parts originate from the original manufacturer.

EMERGENCY STOPS



For all our latest catalogue updates and company info: www.tvh.com

used for: **ANDERSON - 405G1 - SINGLE POLE - 350A**

48 V max.



max. height in OFF: 235 mm
max. height in ON: 257 mm

REF 139TA2665

used for: **ANDERSON - 406G1 - SINGLE POLE - 350A**

72 V max.



max. height in OFF: 235 mm
max. height in ON: 257 mm

REF 139TA2666

used for: **ANDERSON - 503G4 - SINGLE POLE - 175A**

48 V max.



max. height in OFF: 177 mm
max. height in ON: 189 mm

REF 139TA2667

used for: **ELEKTROSISTEM - BDS150 - SINGLE POLE - 150A**

48 V max.



max. height in OFF: 88 mm
max. height in ON: 95 mm

REF 139TA2668

used for: **ELEKTROSISTEM - BDS200 - SINGLE POLE - 200A**

max. height in OFF: 146 mm
max. height in ON: 158 mm



REF 139TA2670

max. height in OFF: 106 mm
max. height in ON: 116 mm



REF 139TA2669

max. height in OFF: 114 mm
max. height in ON: 124 mm



REF 139TA2671

O.E.M. references are purely indicative and do not imply that parts originate from the original manufacturer.



EMERGENCY STOPS

For all our latest catalogue updates and company info: www.tvh.com

used for: HARDELLET - DOUBLE POLE - 150A

24 V max.



max. height in OFF: 109 mm
max. height in ON: 114 mm

REF [139TA2672](#)

used for: HARDELLET - SINGLE POLE - 150A

24 V max.



max. height in OFF: 144 mm
max. height in ON: 150 mm

REF [139TA2673](#)

48 V max.

enclosed cover
with bracket



max. height in OFF: 95 mm
max. height in ON: 100 mm

REF [139TA2679](#)

48 V max.



max. height in OFF: 77 mm
max. height in ON: 85 mm

REF [139TA2676](#)

48 V max.

enclosed cover



max. height in OFF: 95 mm
max. height in ON: 101 mm

REF [139TA2674](#)

48 V max.

enclosed cover



max. height in OFF: 100 mm
max. height in ON: 105 mm

REF [139TA2675](#)

48 V max.

enclosed cover
with bracket



max. height in OFF: 95 mm
max. height in ON: 100 mm

REF [139TA2677](#)

48 V max.

enclosed cover



max. height in OFF: 95 mm
max. height in ON: 100 mm

REF [139TA2680](#)

used for: KISSLING - SERIES 24 - SINGLE POLE - 300A

80 V max.

enclosed cover



max. height in OFF: 113 mm
max. height in ON: 120 mm

REF [139TA2686](#)

80 V max.

with blowouts

enclosed cover



max. height in OFF: 137 mm
max. height in ON: 144 mm

REF [139TA2683](#)



80 V max.

enclosed cover



max. height in OFF: 112 mm
max. height in ON: 122 mm

REF [139TA2681](#)

O.E.M. references are purely indicative and do not imply that parts originate from the original manufacturer.

EMERGENCY STOPS



For all our latest catalogue updates and company info: www.tvh.com

80 V max.



enclosed cover

max. height in OFF: 139 mm
max. height in ON: 146 mm

REF 139TA2685

80 V max.



enclosed cover

max. height in OFF: 115 mm
max. height in ON: 123 mm

REF 139TA2682

80 V max.



enclosed cover

max. height in OFF: 92 mm
max. height in ON: 92 mm

REF 139TA2684

used for: PRESTOLITE - SINGLE POLE - 200A



max. height in OFF: 130 mm
max. height in ON: 130 mm

REF 139TA2687

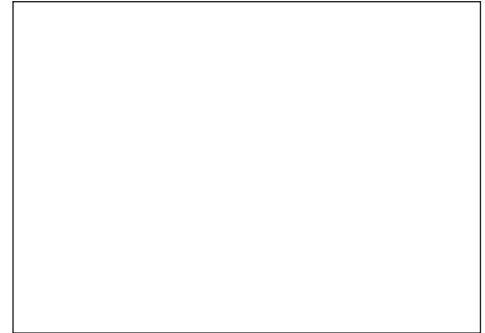
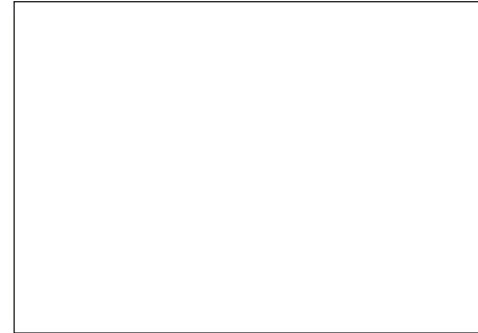

used for: PRESTOLITE - SINGLE POLE - 300A



max. height in OFF: 114 mm
max. height in ON: 114 mm

REF 106TA1229

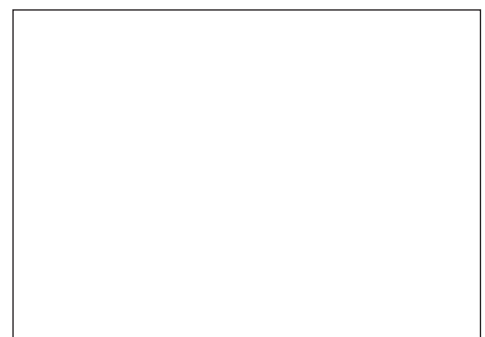
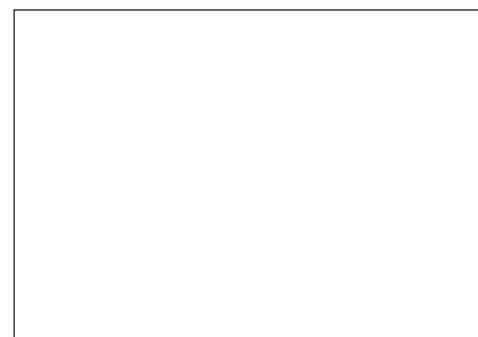

used for: REMA - SINGLE POLE - 100A

enclosed cover



max. height in OFF: 127 mm
max. height in ON: 127 mm

REF 139TA2690

enclosed cover



max. height in OFF: 108 mm
max. height in ON: 108 mm

REF 139TA2689

enclosed cover



max. height in OFF: 127 mm
max. height in ON: 127 mm

REF 139TA2691

used for: REMA - SINGLE POLE - 190A

with blowouts

with black connector



max. height in OFF: 120 mm
max. height in ON: 132 mm

REF 139TA3239



with blowouts



max. height in OFF: 134 mm
max. height in ON: 147 mm

REF 139TA3240



with blowouts

with grey connector



max. height in OFF: 120 mm
max. height in ON: 132 mm

REF 139TA2693



O.E.M. references are purely indicative and do not imply that parts originate from the original manufacturer.



EMERGENCY STOPS

For all our latest catalogue updates and company info: www.tvh.com

with blowouts



max. height in OFF: 136 mm
max. height in ON: 148 mm

REF 139TA2692

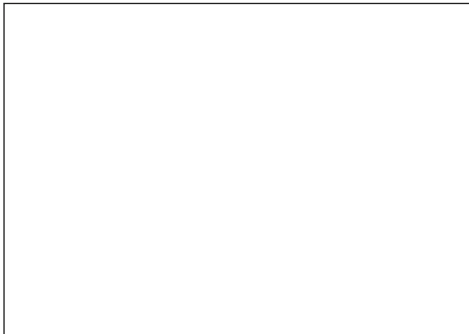
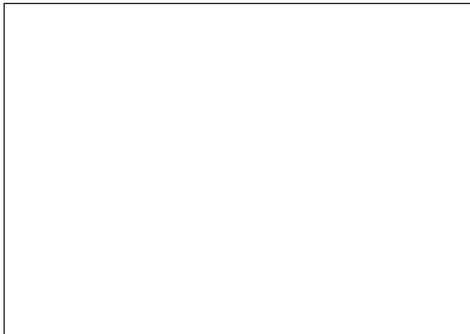
used for: REMA - SINGLE POLE - 300A

with blowouts



max. height in OFF: 110 mm
max. height in ON: 120 mm

REF 139TA2695



with blowouts
with extra holes
for use with aux
switch



max. height in OFF: 103 mm
max. height in ON: 115 mm

REF 139TA2694



with blowouts
with extra holes
for use with aux
switch



max. height in OFF: 103 mm
max. height in ON: 115 mm

REF 139TA2696



with blowouts



max. height in OFF: 113 mm
max. height in ON: 125 mm

REF 139TA2688

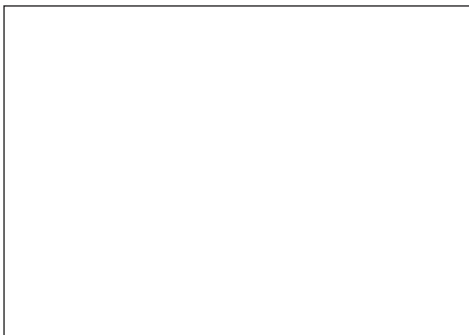
used for: REMA - DIN80A - SINGLE POLE - 125A

with blowouts



max. height in OFF: 122 mm
max. height in ON: 135 mm

REF 139TA2697

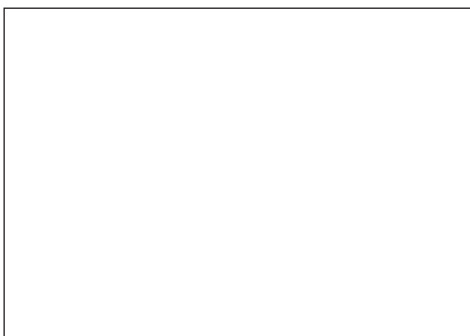
used for: REMA - RN300 - SINGLE POLE - 300A

with blowouts



max. height in OFF: 109 mm
max. height in ON: 122 mm

REF 139TA2698



Look up
these parts via



O.E.M. references are purely indicative and do not imply that parts originate from the original manufacturer.

EMERGENCY STOPS



For all our latest catalogue updates and company info: www.tvh.com

used for: SCHALTBAU - C130/180 - SINGLE POLE - 140A

24 V max.



max. height in OFF: 177 mm
max. height in ON: 184 mm

REF 139TA2699

used for: SCHALTBAU - C130/250 - SINGLE POLE - 120A

48 V max.



max. height in OFF: 155 mm
max. height in ON: 163 mm

REF 139TA2700

used for: SCHALTBAU - S132 - SINGLE POLE - 125A

enclosed cover



max. height in OFF: 79 mm
max. height in ON: 91 mm

REF 139TA2702

with blowouts



max. height in OFF: 111 mm
max. height in ON: 123 mm

REF 139TA2703

with blowouts



enclosed cover

max. height in OFF: 79 mm
max. height in ON: 91 mm

REF 139TA2701

48 V max.

with blowouts



max. height in OFF: 109 mm
max. height in ON: 121 mm

REF 139TA2704

48 V max.

with blowouts



max. height in OFF: 119 mm
max. height in ON: 131 mm

REF 139TA2705

used for: SCHALTBAU - S134 - SINGLE POLE - 250A

with blowouts



max. height in OFF: 132 mm
max. height in ON: 145 mm

REF 139TA2711

with blowouts



max. height in OFF: 190 mm
max. height in ON: 200 mm

REF 139TA2717

with blowouts



max. height in OFF: 132 mm
max. height in ON: 145 mm

REF 139TA2713

O.E.M. references are purely indicative and do not imply that parts originate from the original manufacturer.



EMERGENCY STOPS

For all our latest catalogue updates and company info: www.tvh.com

with blowouts
with pin for use with aux switch



max. height in OFF: 132 mm
max. height in ON: 145 mm

REF 139TA2714



with blowouts
with pin for use with aux switch



max. height in OFF: 132 mm
max. height in ON: 145 mm

REF 139TA2708



with blowouts



max. height in OFF: 177 mm
max. height in ON: 189 mm

REF 139TA2715



with blowouts



max. height in OFF: 95 mm
max. height in ON: 107 mm

REF 139TA2710



with blowouts



max. height in OFF: 132 mm
max. height in ON: 145 mm

REF 139TA2709



with blowouts



max. height in OFF: 132 mm
max. height in ON: 145 mm

REF 139TA2716



with blowouts



max. height in OFF: 95 mm
max. height in ON: 107 mm

REF 139TA2707



with blowouts



max. height in OFF: 126 mm
max. height in ON: 139 mm

REF 139TA2712



with blowouts
assembly of key switch possible



max. height in OFF: 132 mm
max. height in ON: 145 mm

REF 139TA2718



used for: SCHALTBAU - S306 - SINGLE POLE - 160A

with blowouts



max. height in OFF: 126 mm
max. height in ON: 140 mm

REF 139TA2719

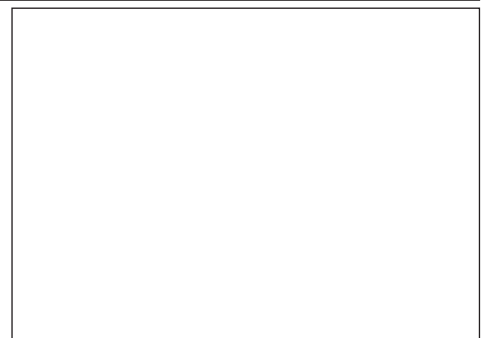
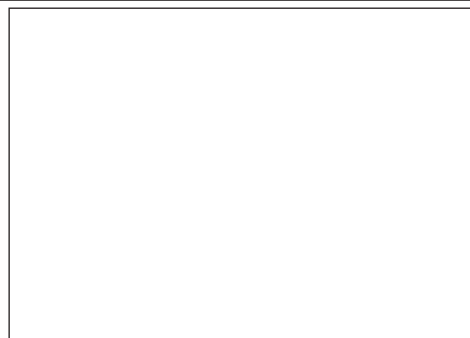
used for: SCHALTBAU - S307 - DOUBLE POLE - 250A

with blowouts



max. height in OFF: 130 mm
max. height in ON: 144 mm

REF 139TA2720



O.E.M. references are purely indicative and do not imply that parts originate from the original manufacturer.

EMERGENCY STOPS



For all our latest catalogue updates and company info: www.tvh.com

used for: **SCHALTBAU - S307 - SINGLE POLE - 250A**

with blowouts



max. height in OFF: 126 mm
max. height in ON: 140 mm

REF 139TA2722



with blowouts



max. height in OFF: 126 mm
max. height in ON: 140 mm

REF 139TA2721

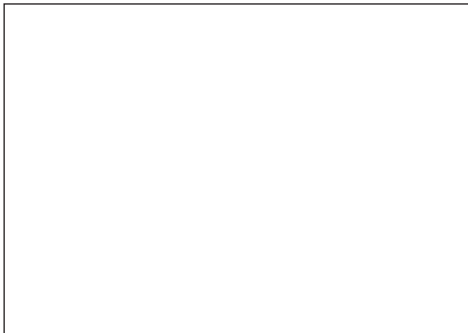

O.E.M. references are purely indicative and do not imply that parts originate from the original manufacturer.

EMERGENCY STOP BUTTONS

For all our latest catalogue updates and company info: www.tvh.com



TECHNISCHE FICHE KNOP NOODSTOP

Groep
02-03-02-01



Voorbeeld



Gegevens klant

Type machine:

Prijsaanvraag

Serie nr. machine:

Bestelling

CODE: TYx D x Z1 x Z2 x H x TA x EXT x HRDW

- ... TY..... Type knop:
A = rond.
B = rechthoekig.
- ... D..... Grootste buitendiameter, indien rond.
- ... Z1..... Grootste lengte knob, indien rechthoekig.
- ... Z2..... Kleinste lengte knob, indien rechthoekig.
- ... H..... Totale hoogte.
- ... TA Inwendige draadsoort, indien aanwezig.
- ... EXT Verlengstuk aanwezig: JA/NEE.
- ... HRDW..... Hardware inbegrepen: JA/NEE.

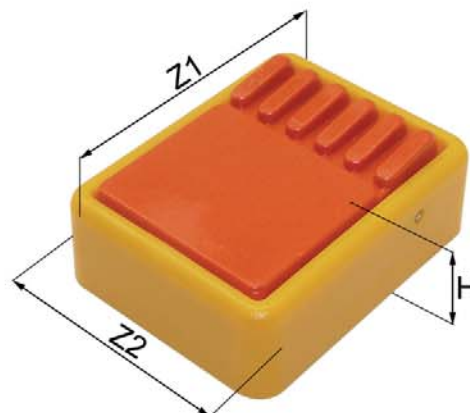
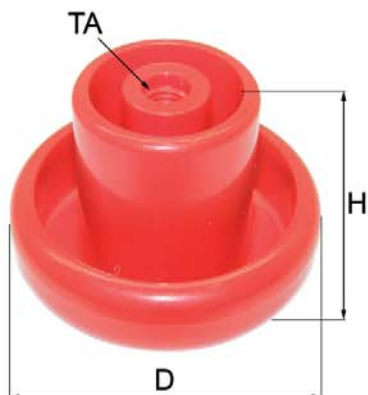



FICHE TECHNIQUE BOUTON D'ARRET D'URGENCE

Groupe
02-03-02-01



Exemple

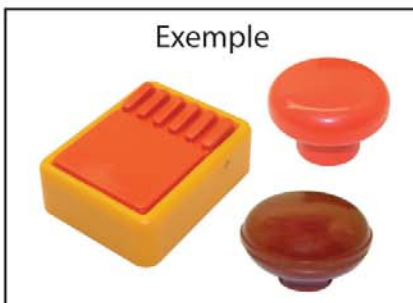

Nom de votre société

Type machine : Demande de prix
No. série machine : Commande

CODE : TYx D x Z1 x Z2 x H x TA x EXT x HRDW

- ... TY..... Type de bouton :
A = *rond*.
B = *rectangulaire*.
- ... D..... Plus grand diamètre extérieur, si rond.
- ... Z1..... Plus grande longueur du bouton, si rectangle.
- ... Z2..... Plus petite longueur du bouton, si rectangle.
- ... H..... Hauteur totale.
- ... TA Type de filetage.
- ... EXT Rallonge présente : OUI/NON.
- ... HRDW..... Hardware inclus : OUI/NON.

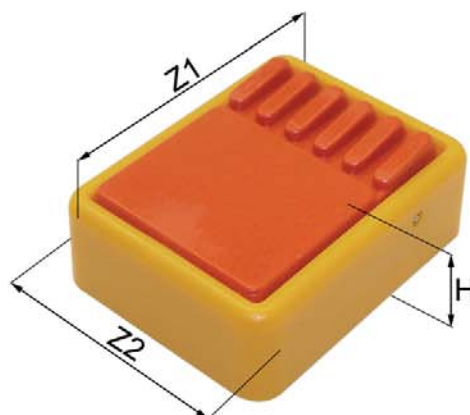
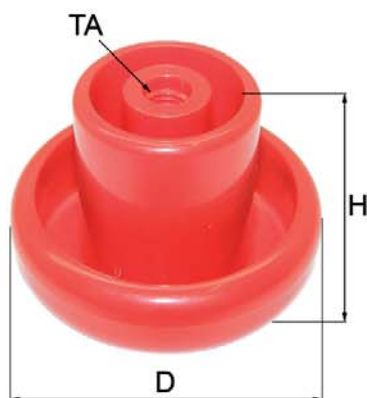

EMERGENCY STOP BUTTONS



For all our latest catalogue updates and company info: www.tvh.com

TECHNICAL SHEET EMERGENCY STOP BUTTON

Group
02-03-02-01



Example

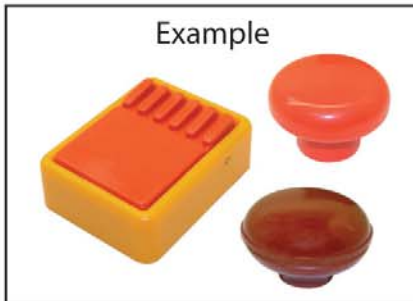

Customer details

Type machine:

Price inquiry

Serial no. machine:

Order

CODE: TYx D x Z1 x Z2 x H x TA x EXT x HRDW

- ... TY..... Type of knob:
A = round.
B = square.
- ... D..... Biggest diameter of the knob, if round.
- ... Z1..... Biggest side of the knob, if square.
- ... Z2..... Smallest side of the knob, if square.
- ... H..... Total height of the knob.
- ... TA Type of internal thread, if present.
- ... EXT Extender included YES/NO.
- ... HRDW..... Hardware included YES/NO.

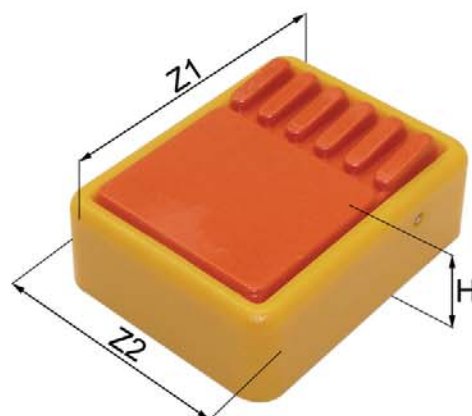
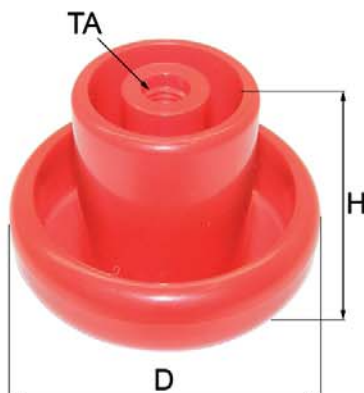



TECHNISCHES DATENBLATT NOTSTOPPTASTE

Gruppe
02-03-02-01



Beispiel



Kundendaten

Maschinentyp: Preisanfrage
 Serienr.maschine: Bestellung

CODE: TYx D x Z1 x Z2 x H x TA x EXT x HRDW

- ... TY..... Tastentyp:
 A = rund.
 B = rechteckig.
- ... D..... Größter Aussendurchmesser, wenn rund.
- ... Z1..... Größte Tastenlänge, wenn rechteckig.
- ... Z2..... Kleinste Tastenlänge, wenn rechteckig.
- ... H..... Gesamthöhe.
- ... TA Innengewinde, wenn anwesend.
- ... EXT Verlängerungsstück anwesend: JA/NEIN.
- ... HRDW..... Hardware inbegriffen: JA/NEIN.

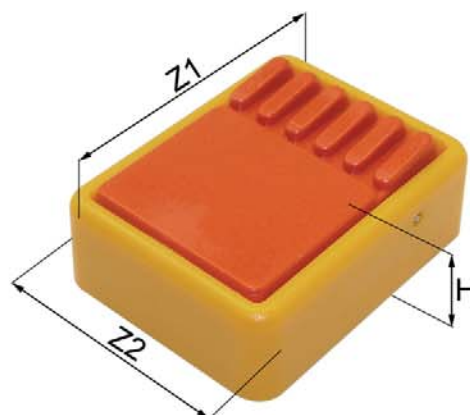
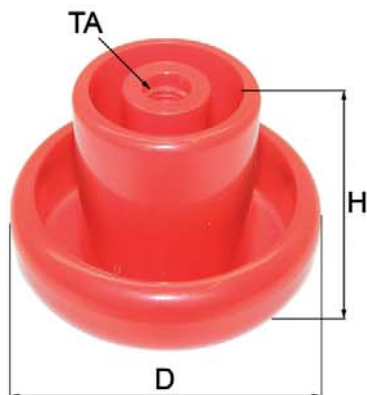



EMERGENCY STOP BUTTONS

For all our latest catalogue updates and company info: www.tvh.com

used for: ALBRIGHT

knob: Ø 50 mm

height: 48 mm

internal thread: M8



REF 139TA2553

knob: Ø 51 mm

height: 33 mm

internal thread: M10



REF 139TA2554

knob: Ø 58 mm

height: 42 mm

internal thread: M8



REF 107TA1103

knob: Ø 58 mm

height: 42 mm

internal thread: M8



REF 139TA2555

used for: ELEKTROSISTEM

knob: Ø 57 mm

height: 29 mm

internal thread: M6



REF 139TA2556

used for: HARDELLET

knob: Ø 51 mm

height: 38 mm

internal thread: M8



REF 116TA5222

knob: Ø 55 mm

height: 35 mm

internal thread: M8



REF 139TA2557

knob: Ø 55 mm

height: 45 mm

internal thread: M8



REF 139TA2558

knob: Ø 56 mm

height: 34 mm

internal thread: M8



REF 107TA1109

knob: Ø 50 mm

height: 35 mm

internal thread: M8



REF 107TA1111

O.E.M. references are purely indicative and do not imply that parts originate from the original manufacturer.

EMERGENCY STOP BUTTONS



For all our latest catalogue updates and company info: www.tvh.com

used for: KISSLING

knob: Ø 50 mm

height: 40 mm

internal thread: M8



REF 112TA5001

knob: Ø 57 mm

height: 42 mm

internal thread: M8



REF 111TA3904

used for: PRESTOLITE

knob: Ø 57 mm

height: 42 mm

internal thread: M8



REF 107TA1110

used for: REMA

knob: Ø 36 mm

height: 47 mm



REF 139TA2559

knob: 22 x 50 mm

height: 36 mm



REF 139TA2560

knob: 50 x 64 mm

height: 23 mm



REF 139TA2561

used for: SCHALTBAU

knob: Ø 50 mm

height: 29 mm

internal thread: M8



REF 139TA2562

knob: Ø 50 mm

height: 42 mm

internal thread: M8



REF 111TA3899

knob: Ø 54 mm

height: 39 mm

internal thread: M8



REF 107TA1124

knob: Ø 57 mm

height: 47 mm



REF 139TA2563

knob: Ø 58 mm

height: 45 mm



REF 139TA2564

knob: Ø 59 mm

height: 30 mm

internal thread: M6



REF 139TA2565

O.E.M. references are purely indicative and do not imply that parts originate from the original manufacturer.



EMERGENCY STOP BUTTONS

For all our latest catalogue updates and company info: www.tvh.com

knob: Ø 59 mm

height: 30 mm

internal thread: M6



REF 139TA2566

knob: 70 x 59 mm

height: 68 mm



REF 139TA2567

knob: 79 x 104 mm

height: 36 mm



REF 139TA2568

knob: Ø 50 mm

height: 34 mm

internal thread: M8



REF 139TA2569

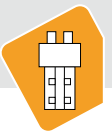

Out soon: your free interactive on-line webshop for spare parts

Your current **TVH Quick Source** will soon be transformed into a completely new e-commerce website!

Explore the new inquiry and order system of **"MyTotalSource"**: forwarding price inquiries and orders will be faster, easier and more user-friendly, only one click away.

Coming soon!
TVH Quick Source web-based

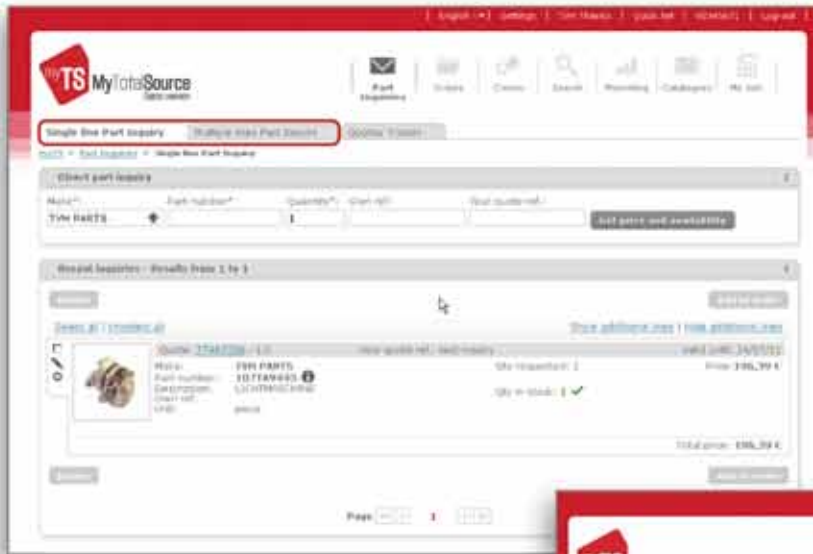

- **Direct part inquiry:** for a quick price and lead time of only 1 item
- **Input multiple records:** for price and lead time of several parts
- **Instant price, availability and picture**

View your quotes up to 1 year back in the tab "Quotes' history".

Trace your quote using the easy search fields.

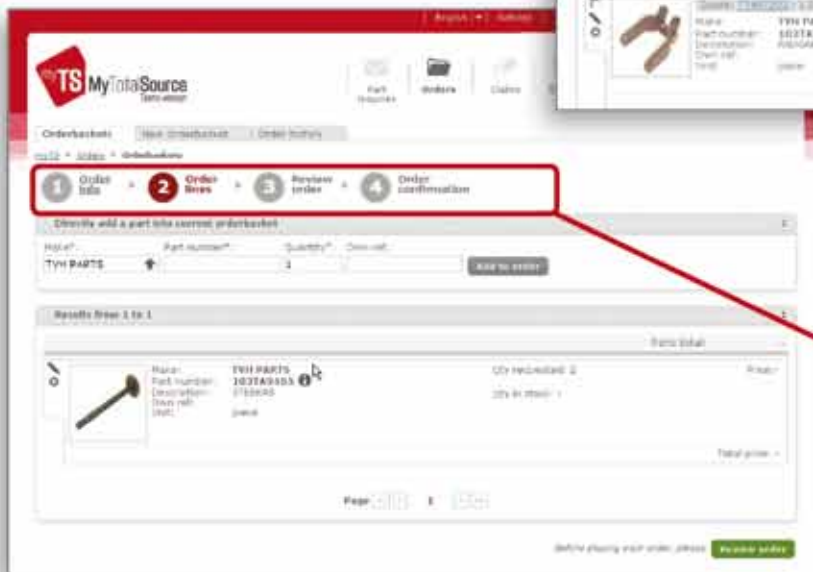

Fast, simple and flexible on-line ordering of spare parts 24 hours a day

Discover the **new 4-steps order system:**

- 1) Create your order basket
- 2) Change your order
- 3) View your order
- 4) Finalize and confirm your order



CONTACTORS & CONTACTS

For all our latest catalogue updates and company info: www.tvh.com

INDEX: CONTACTOR MAKES

	ALBRIGHT	CABLEFORM	GENERAL ELECTRIC	HARDELLET	PRESTOLITE	AMERICAN	SPECIAL FRENCH	SPECIAL GERMAN	JAPANESE	OTHER MAKES
ALBRIGHT	•									
AMELEC				•			•			
AMETEK					•					
BOSCH								•		
CABLEFORM		•								
CONTACT INDUSTRIES					•	•				
DENSO									•	
ELEKTRON	•									
GENERAL ELECTRIC	•		•			•				•
H.B.					•					
HARDELLET				•						
HITACHI									•	
JOHN MORRIS										•
KYORITSU-KEIKI									•	
MEIDEN									•	
NIKKO									•	
PRESTOLITE					•					
SCHALTBAU								•		
SEVCON	•									•
SHINKO									•	
SQUARE D						•				
TELEMECANIQUE							•			
UNELEC										•



PAGE INDEX			
CHAPTER	SEPARATE CONTACTS	CONTACT KITS	PAGE
ALBRIGHT	ALBRIGHT CONTACTS		87
		ALBRIGHT KITS	94
AMERICAN	SPECIAL ALLIS CHALMERS CONTACT INDUSTRIES CONTACTS SPECIAL CUSHMAN SPECIAL HYSTER SPECIAL PETTIBONE SQUARE D CONTACTS SPECIAL YALE		148
		SPECIAL ALLIS CHALMERS CONTACT INDUSTRIES KITS SQUARE D KITS	152
CABLEFORM	CABLEFORM CONTACTS		107
		CABLEFORM KITS	112
GENERAL ELECTRIC	GENERAL ELECTRIC CONTACTS		115
		GENERAL ELECTRIC KITS	123
HARDELLET	HARDELLET CONTACTS		131
		HARDELLET KITS	133
JAPANESE	SPECIAL BISHAMON DENSO CONTACTS HITACHI CONTACTS SPECIAL KOMATSU KYORITSU KEIKI CONTACTS MEIDEN CONTACTS NIKKO CONTACTS SPECIAL NISSAN SPECIAL NYK SHINKO CONTACTS SPECIAL TCM SPECIAL TOYOTA		171
		HITACHI KYORITSU KEIKI KITS MEIDEN NIKKO KITS NYK	188
OTHER MAKES	SPECIAL BALKANCAR SPECIAL CESAB SPECIAL CLARK SPECIAL FIAT SPECIAL KALMAR - CLIMAX SPECIAL LANSING UNELEC CONTACTS		193
		SPECIAL CLARK JOHN MORRIS KITS SEVCON KITS UNELEC KITS	204
PRESTOLITE	PRESTOLITE CONTACTS SPECIAL RAYMOND see AMERICAN		137
		PRESTOLITE KITS SPECIAL RAYMOND see AMERICAN	141
SPECIAL FRENCH	AMELEC CONTACTS SPECIAL FENWICK TELEMECANIQUE CONTACTS		155
		AMELEC KITS SPECIAL SAXBY TELEMECANIQUE KITS	158
SPECIAL GERMAN	BOSCH CONTACTS SPECIAL JUNGHEINRICH SCHALTBAU CONTACTS SPECIAL STEINBOCK SPECIAL STILL SPECIAL STILL - LINDE		161
		SPECIAL BOSCH SCHALTBAU KITS SPECIAL STILL	167



CONTACTORS & CONTACTS

For all our latest catalogue updates and company info: www.tvh.com

INDEX: FORKLIFT TRUCK MAKES

	ALBRIGHT	CABLEFORM	GENERAL ELECTRIC	HARDELLET	PRESTOLITE	AMERICAN	SPECIAL FRENCH	SPECIAL GERMAN	JAPANESE	OTHER MAKES
ALLIS CHALMERS - KALMAR AC		
AMEISE		
ATLET - LAFIS
BALKANCAR		.								.
BISHAMON									.	
BRUNILIFT		.								
BT		
BV ROCLA	.									
CATERPILLAR	
CESAB										.
CLARK
COVENTRY CLIMAX										.
CROWN				
CUSHMAN						.				
ESSELINGEN		
FENWICK
FIAT-OM PIMESPO	.		.							.
HAMECH
HYSTER
HYUNDAI-HALLA									.	
JUNGHEINRICH		
KALMAR
KOMATSU	
LAFIS					.					
LANCER BOSS		
LANSING	.									.
LAURAK		.							.	.
LINDE		
LOC				.						
LUGLI			.							
MIC				.					.	
MITSUBISHI			.			.			.	
NISSAN									.	
NYK									.	
PEG			.				.			
PETTIBONE			.			.				
PRAT	.									
RANSOMES
RAYMOND	.				.	.				
ROCLA	.			.						
SALEV	.			.			.			
SAXBY - MATRAL	.			.			.			
STEINBOCK - BOSS		
STILL		
SUGICO									.	
TCM			.						.	
TECNOCAR		.								.
TOWMOTOR	
TOYOTA						.			.	
WAGNER	.		.					.		
YALE