

STAPLER-ERSATZTEILE.COM

Hydraulikteile & Zubehör

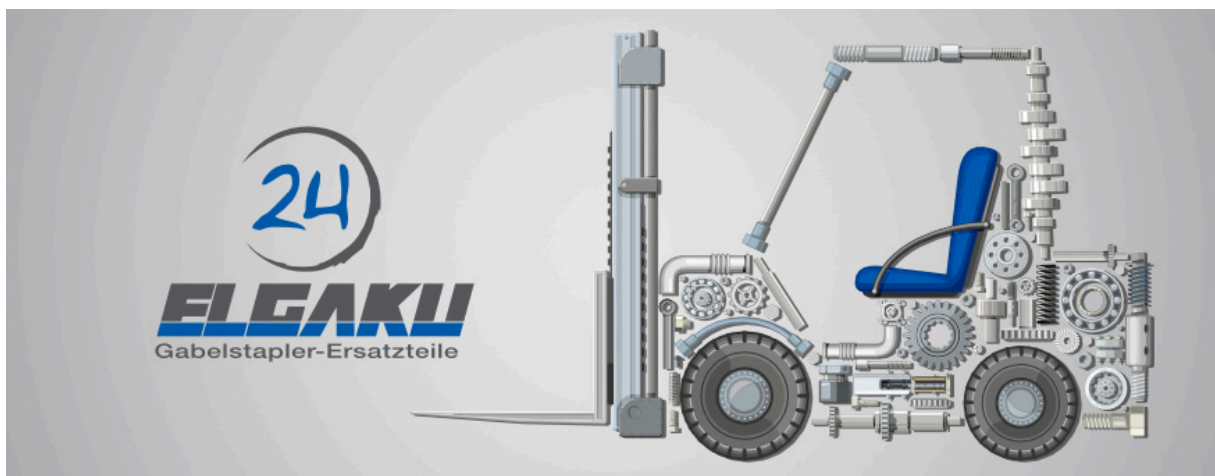



Über TVH	I	Hydraulikaggregate	261
Inhaltverzeichnis	A	Hydraulikgeneratoren	293
· English	A	Hydraulikschläuche & Zubehör	297
· Nederlands	B	Hydraulikkupplungen	311
· Français	C	Rohrverschraubungen	343
· Deutsch	D	Triple-Lok Plus	351
· Español	E	Schutzhülle	357
· Italiano	F	Bogenzahnkupplung	385
· Português	G	Trommeln	395
· Polski	H	Zubehör	403
· Русский	I	Hydraulikanzeigen & -Testgeräte	407
Gut zu wissen	K	Werkzeuge	417
Hydraulikpumpen	1	Wartung, Reparatur & Instandhaltung	421
Lenkeinheiten	31		
Hydraulikmotoren	45		
Hydraulikverteiler	59		
Zusatzventile & Handgriffsätze	63		
Getriebeventile	81		
Magnetventilspule	85		
Elektroventil-Elemente	93		
Hydraulikventile & Komponenten	95		
Hydraulikfilter	113		
Akkumulatoren	115		
Hydraulikzylinder	129		
Hydraulikdichtungen	141		
· O-Ring	149		
· Nutring	154		
· Abstreifer	165		
· Verbunddichtung	178		
· Kolbendichtung	186		
· Führungsring	199		
· Stützring	216		
· V-Ring	223		
· Geklebte Dichtung	229		
· Ölsimmerring	235		



1

HYDRAULIC PUMPS



HYDRAULIC PUMPS



TVH has a large stock of hydraulic pumps for all material handling makes and models.
We stock over 2000 different pumps.

We can offer you the brands below:

Bondioli & Pavesi, Bosch – Rexroth, Bucher, Caproni, Casappa, Chapel, Concentric (Haldex – John S Barnes), Danfoss, Eaton (Vickers), Eckerte, Galtech, HPI, Hydreco (David Brown), Kawasaki, KYB, Linde Hydraulics, Marzocchi, Nihon Spindle, Parker (Ultra – Dowty – Commercial – Denison), Roquet, Salami, Shimadzu, Turolla



HOW TO FIND THE CORRECT HYDRAULIC PUMP

To order a hydraulic pump give us the full details on the ID plate on the pump, engravings in the pump housing or by giving us the complete machine details.

Example

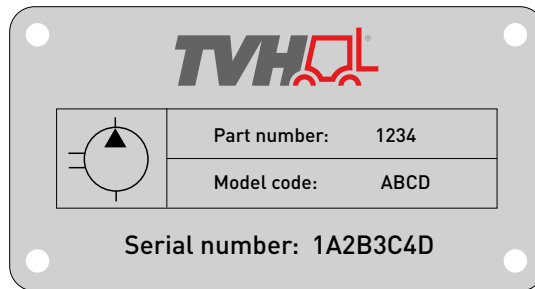

If you have an ID plate we need the following details in order to find the correct pump: Brand (example TVH), Partnumber (example: 1234), Modelcode (example: ABCD). If you could send us a clear and readable picture of the ID plate on the pump, this will also enable us to find the correct pump for you.

If you have a double pump in most cases the front pump (with shaft and mounting flange) will have the ID plate for the complete assy.

Look up your hydraulic pump via
MyProductSearch in **MyTotalSource**



If you have questions or troubles finding the correct pump in MyProductSearch, please contact your sales advisor.

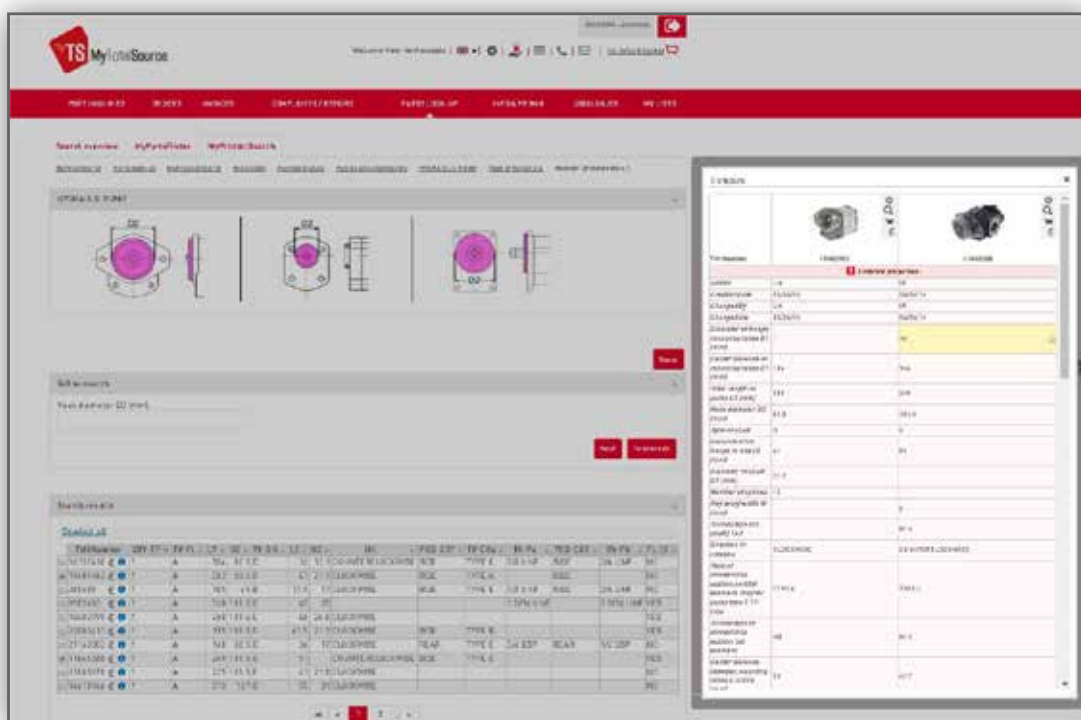



WARRANTY SHEET: HYDRAULIC PUMP



General guide lines for the replacement of a hydraulic pump:

- Hydraulic reservoir and connecting leads/tubes must be bled and cleaned
- Replace ALL hydraulic filters, check suction-lead for leaks and replace (if present) suction filter
- Only use oil recommended by the manufacturer
- Do not drive or force the coupling on the shaft
- Lubricate the shaft end before installation
- Use the right couplings and connections
- Fill up suction-lead completely
- Fill the pumps casing completely with oil
- Always check the direction of rotation of the pump before fitting it in the machine
- **Before starting** the engine, always make sure that the **pressure relief** valve is brought to **a zero level** and run the system at zero pressure for a few minutes, **before gradually increasing** the **pressure** to the manufacturers recommended level

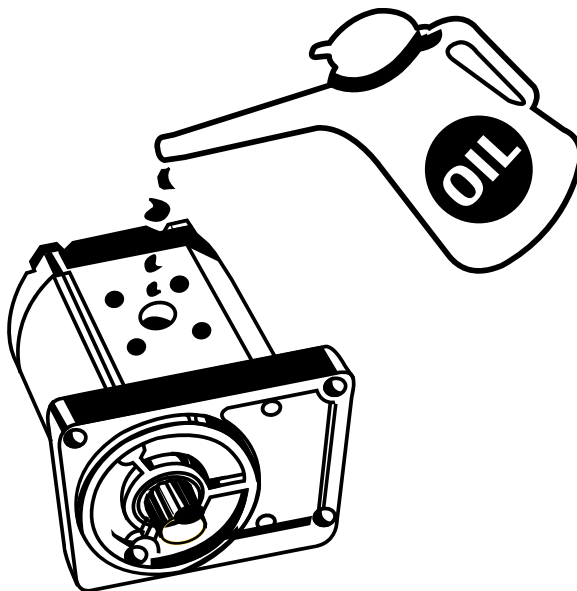

BEFORE MOUNTING:

fill all ports with enough oil ISO 46

Please see “link /QR code” for a video on how to correctly install a hydraulic pump,
<https://vimeo.com/tvhgroup/hydraulicpump>



Failure to comply with above will invalidate warranty.



PUMP TEST BENCH FOR HYDRAULIC GEAR PUMPS & HYDRAULIC PISTON PUMPS

In our workshop we have qualified hydraulic technicians and hydraulic test facilities to recondition and test our reconditioned. All units are tested on our in-house developed test bench. This test bench enables us to measure the speed, flow and system pressure and register possible pressure losses. We can also build up the pressure in the hydraulic system to simulate a work load.



Most gear pumps can be tested on the test bench. Also pumps with load-sensing valves.



Ergonomic and easy to use control panel. Test certificate can be printed of each test procedure.



We can test hydrostatic piston pumps.





BOSCH - REXROTH



BUCHER



CAPRONI





CASAPPA



CHAPEL



CONCENTRIC (HALDEX - JOHN S BARNES)





DANFOSS



EATON (VICKERS)



ECKERLE





HYDRECO (DAVID BROWN)



HPI



KYB





LINDE HYDRAULICS



MARZOCCHI



PARKER (ULTRA-DOWTY - COMMERCIAL - DENISON)





ROQUET



SALAMI

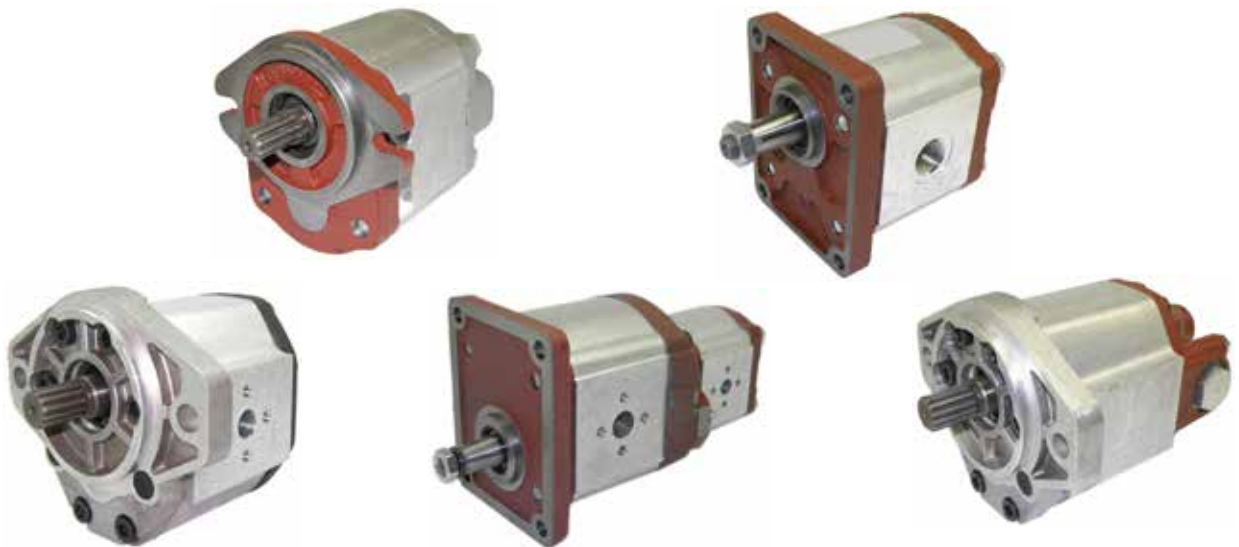

SHIMADZU





TUROLLA





TECHNICAL DETAIL: HYDRAULIC PUMP

The technical sheet can help us to find the pump you need

Group
03-04-02-00



Customer details

Type machine:
Serial n° machine:

Price inquiry
Order

CODE: TY-PU x QTY-EP x TY-FL x D1 x TA1 x C1 x C2 x L1 x D2 x L1 x D2 x TY-SH x L2 x D3 x QTY-SPL x W x TA2 x TAP x POS-CO1 x TY-COa x TA-COa x C-CO1a x C-CO2a x D-Pa x TA-Pa x POS-CO2 x TY-COb x TA-COb x C-CO1b x C-CO2b x D-Pb x TA-Pb x POS-CO3 x TY-COc x TA-COc x C-CO1c x C-CO2c x D-Pc x TA-Pc x POS-CO4 x TY-COd x TA-COd x C-CO1d x C-CO2d x D-Pd x TA-Pd x FL-DI x QTY-DI x TA3 x TA4 x Q x P x MAT x CPL

[Empty box for notes or additional information]

- TY-PU Type of pump:
 - T = gear pump*
 - S = fin pump*
 - P = plunger pump*
- QTY-EP..... Number of elements.
- TY-FL..... Type of flange.
- D1 Diameter of flange mounting holes (mm).
- TA1 Type of thread of mounting holes (mm).
- C1..... Center distance of mounting holes (mm).
- C2..... Center distance of mounting holes (mm).
- L1..... Total length of pump (mm).
- D2 Neck diameter (mm).
- TY-SH Type of shaft.
- L2..... Distance flange to end of shaft (mm).
- D3 Diameter of shaft (mm).
- QTY-SPL..... Number of splines.
- W Key (way) width (mm).
- TA2 Type of thread (on shaft).



TECHNICAL DETAIL: HYDRAULIC PUMP

- TAP Cone 1/5 or 1/8, if type G.
- DR Direction of rotation:
CW = clockwise
CCW = counter clockwise
BI = bi-rotational
- POS-CO1 Position of suction port 1st element, only for pump type T:
F = front
R = rear
S = side
- TY-COa Type of connections suction port 1st element, only for pump type T.
- TA-COa Thread type of connection suction port 1st element.
- C-CO1a Center distance between mounting holes (mm).
- C-CO2a Center distance between mounting holes (mm).
- D-Pa Diameter suction side of 1st element (mm).
- TA-Pa Thread type suction side of 1st element.
- POS-CO2 Position of pressure port 1st element, only for pump type T:
F = front
R = rear
S = side
- TY-COb Type of connections pressure port 1st element, only for pump type T.
- TA-COb Thread type of connections pressure 1st element.
- C-CO1b Center distance between mounting holes (mm).
- C-CO2b Center distance between mounting holes (mm).
- D-Pb Diameter pressure side of 1st element (mm).
- TA-Pb Thread type pressure side of 1st element.
- POS-CO3 Position of suction port 2nd element, only for pump type T:
F = front
R = rear
S = side
- TY-COc Type of connection suction port 2nd element, only for pump type T.
- TA-COc Thread type of connection suction port 2nd element.
- C-CO1c Center distance between mounting holes (mm).
- C-CO2c Center distance between mounting holes (mm).
- D-Pc Diameter suction side of 2nd element (mm).



TECHNICAL DETAIL: HYDRAULIC PUMP

- TA-Pc Thread type suction side of 2nd element.
- POS-CO4 Position of pressure port 2nd element, only for pump type T:
F = front
R = rear
S = side
- TY-COd Type of connections pressure port 2nd element, only for pump type T.
- TA-COd Type of thread of connections pressure port 2nd element.
- C-CO1d Center distance between mounting holes (mm).
- C-CO2d Center distance between mounting holes (mm).
- D-Pd Diameter pressure side of 2nd element (mm).
- TA-Pd Thread type pressure side of 2nd element.
- FL-DI Flow control valve present: YES/NO.
- QTY-DI Number of valve exits.
- TA3 Biggest type of thread valve.
- TA4 Second type of thread valve.
- Q Flow rate (cc/rev).
- P Maximum pressure of the pump.
- MAT Material of the housing:
AL = aluminium
M = metal
ALM = aluminium and metal
- CPL Coupling present: YES/NO.

TYPE OF PUMP

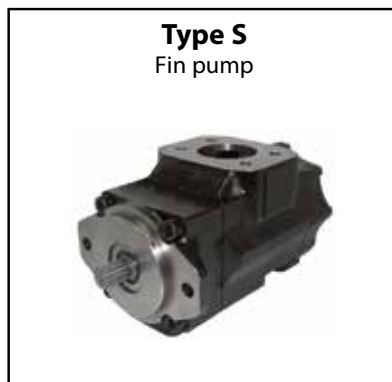



TECHNICAL DETAIL: HYDRAULIC PUMP

TYPE OF FLANGE

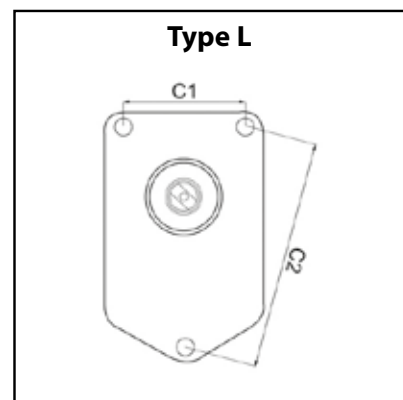
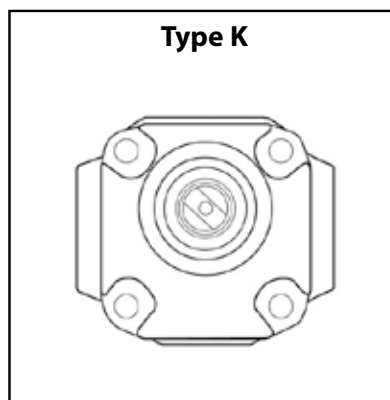
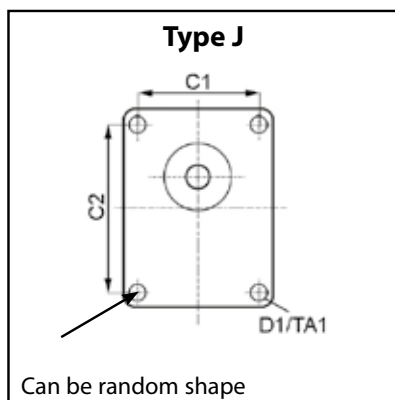
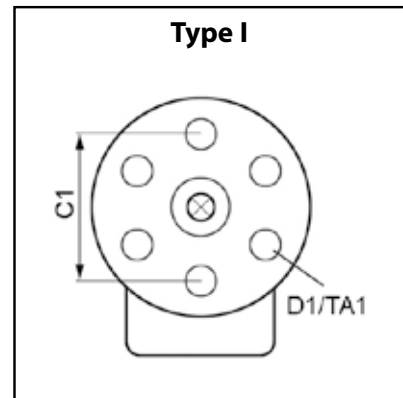
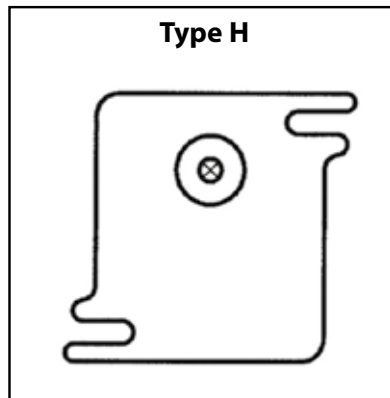
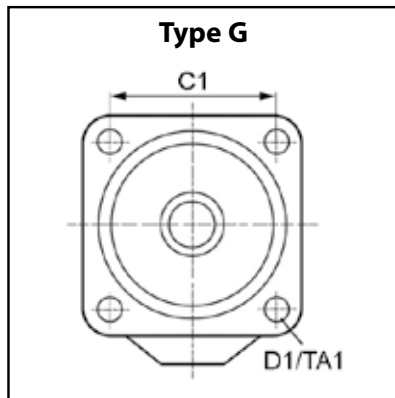
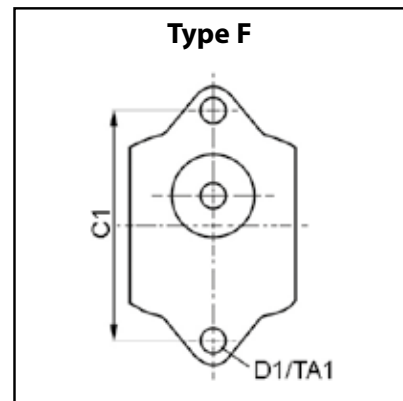
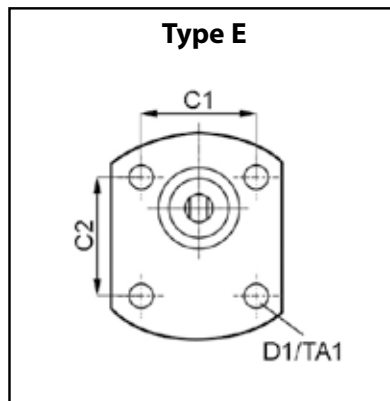
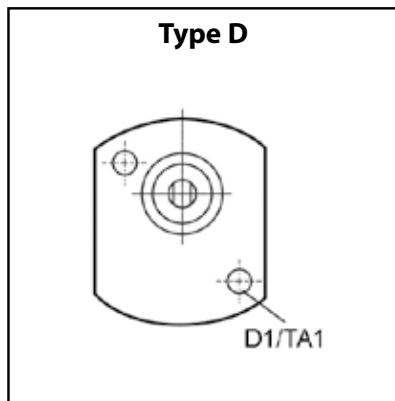
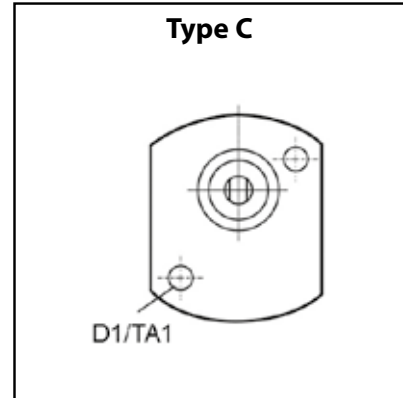
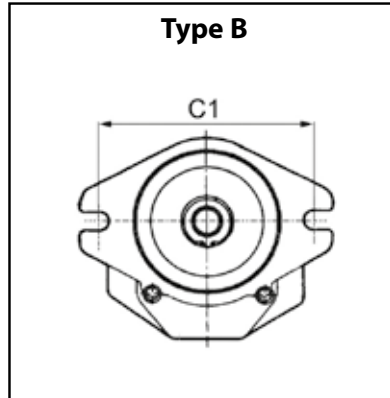
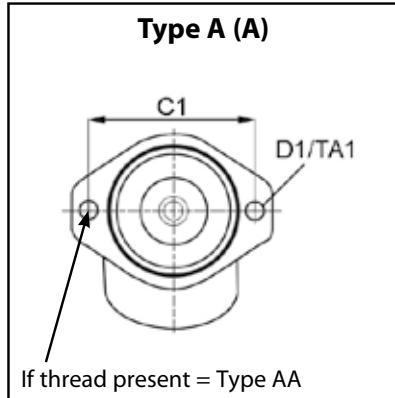



TECHNICAL DETAIL: HYDRAULIC PUMP

TYPE OF FLANGE

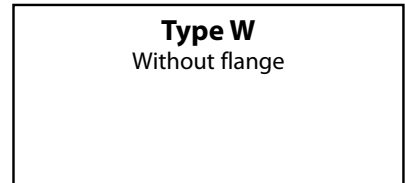
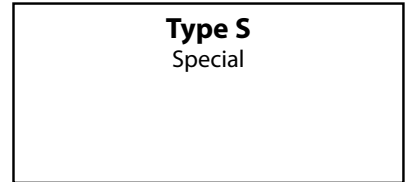
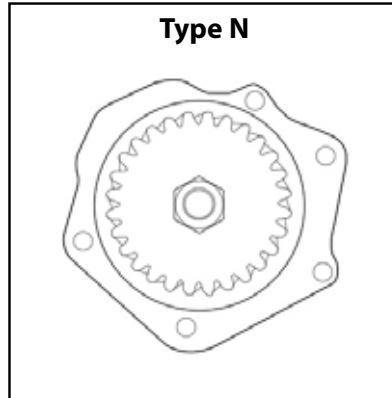
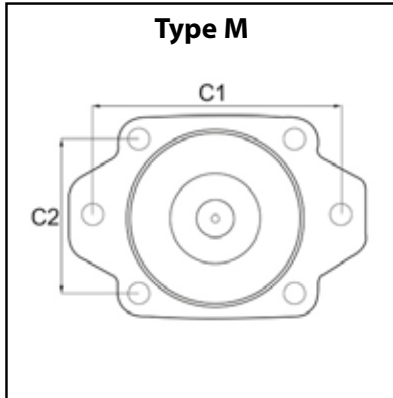

DIMENSIONS

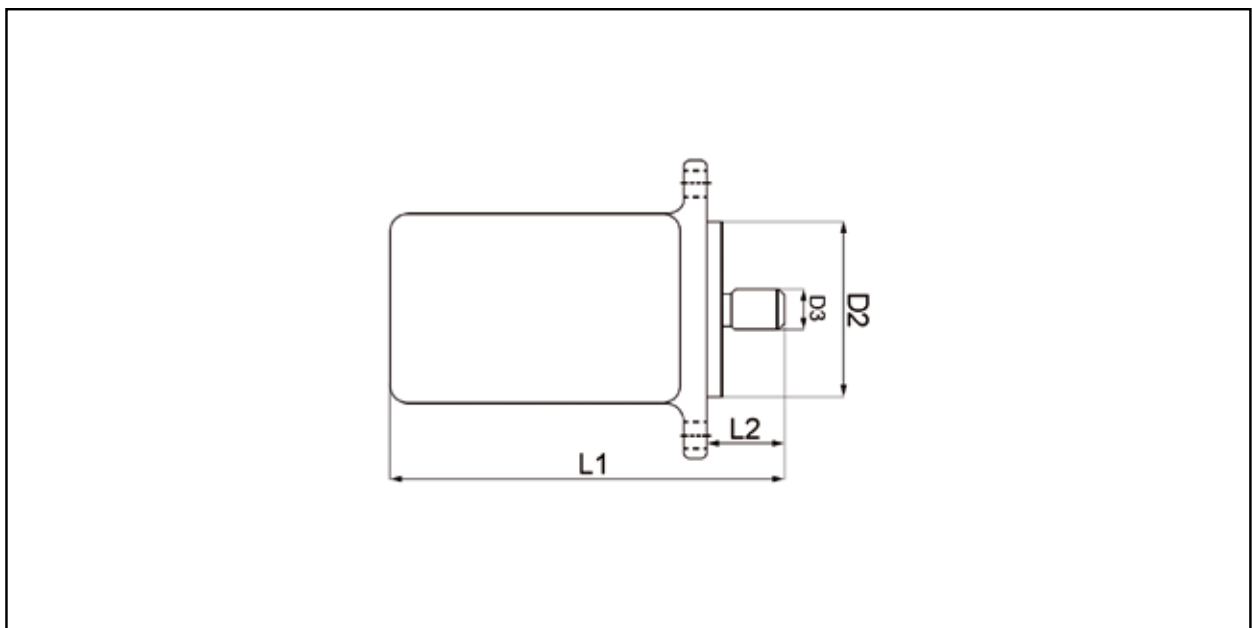

DIRECTION OF ROTATION

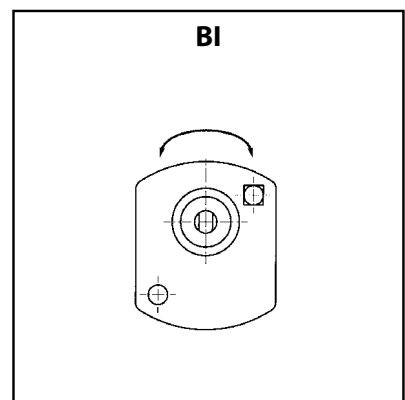
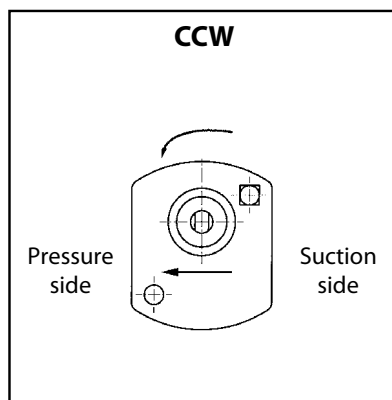
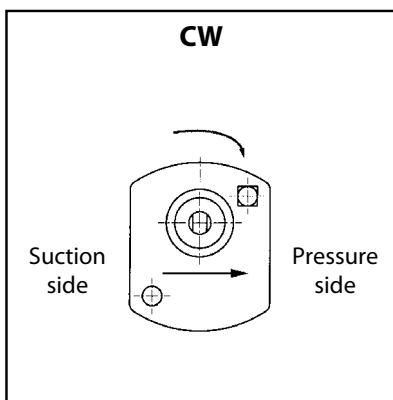



TECHNICAL DETAIL: HYDRAULIC PUMP

TYPE OF SHAFT

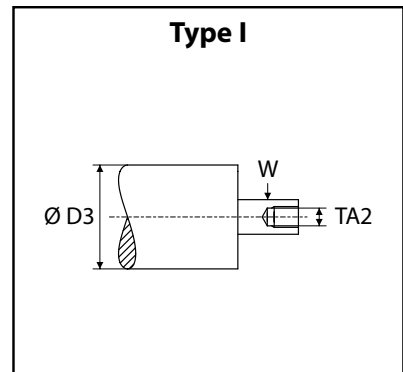
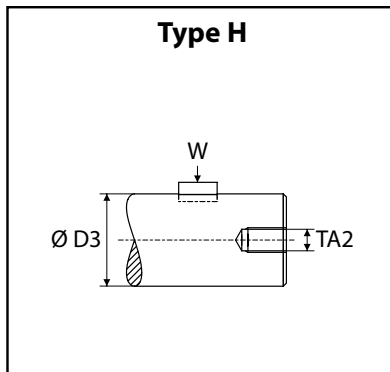
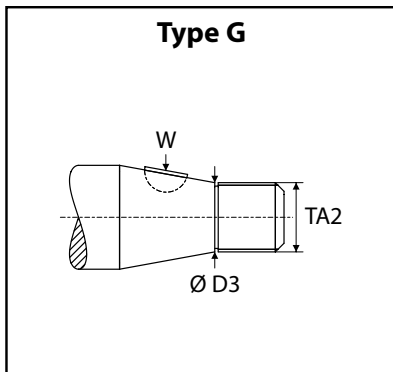
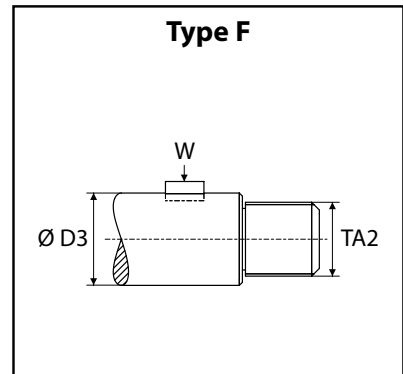
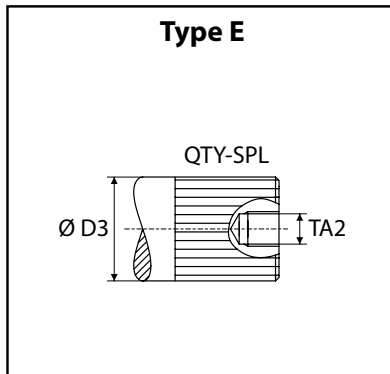
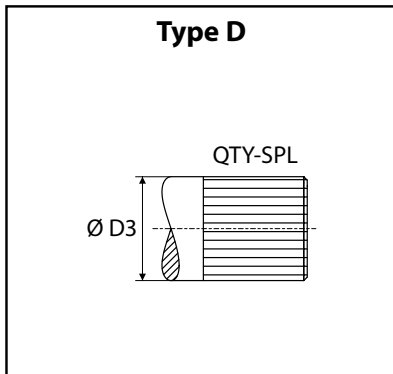
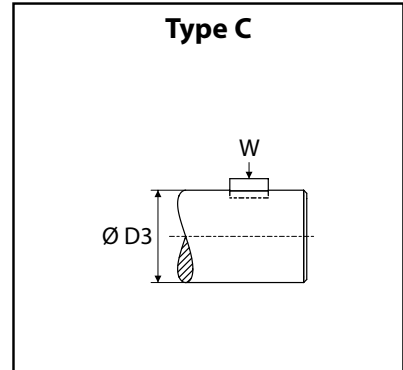
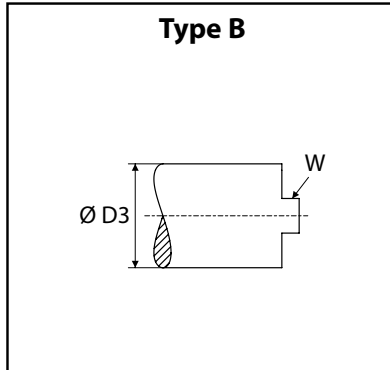
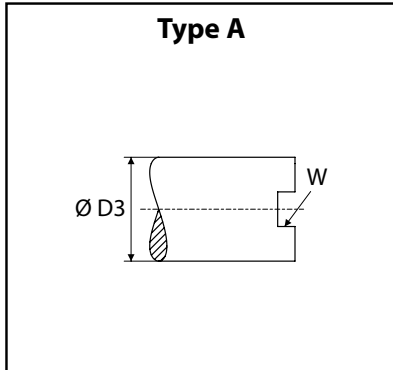

POSITION OF SUCTION PORT

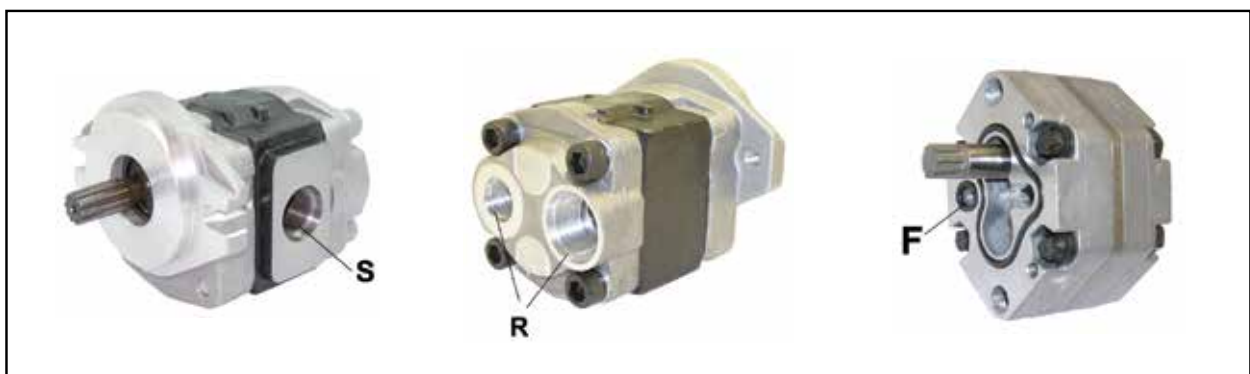



TECHNICAL DETAIL: HYDRAULIC PUMP

TYPE OF CONNECTIONS SUCTION PORT

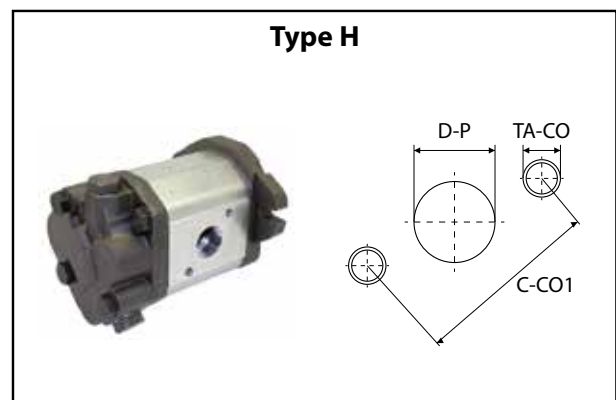
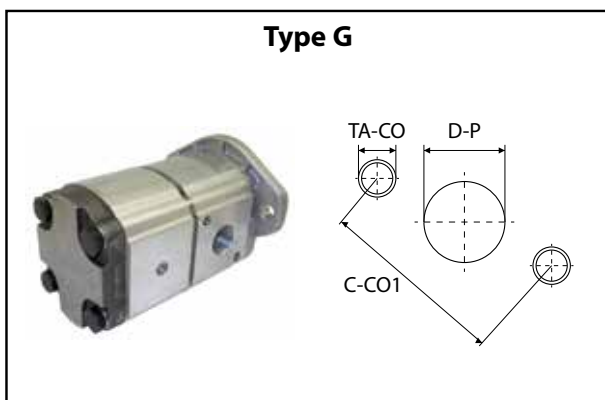
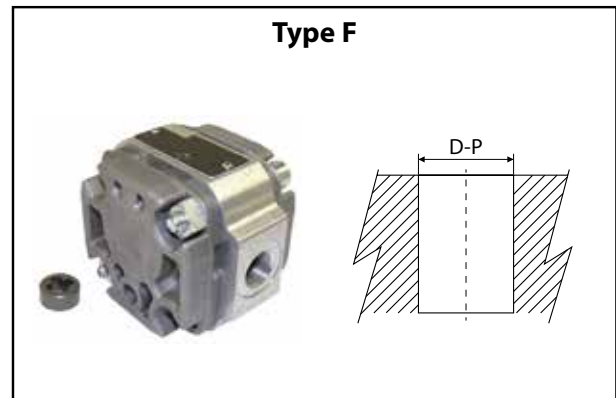
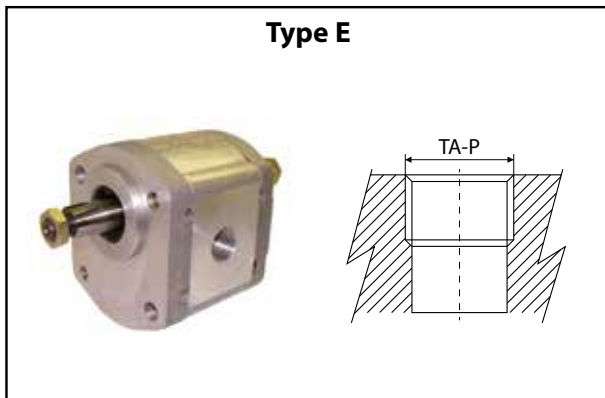
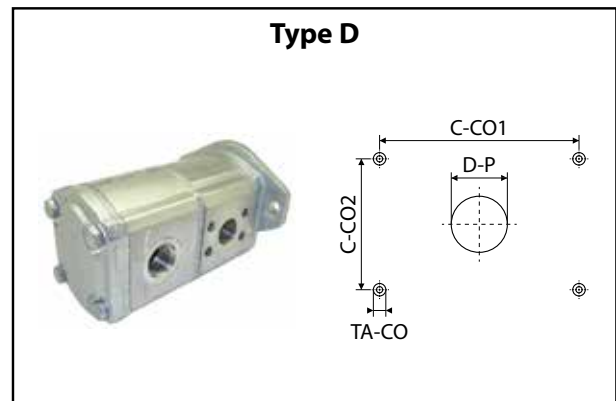
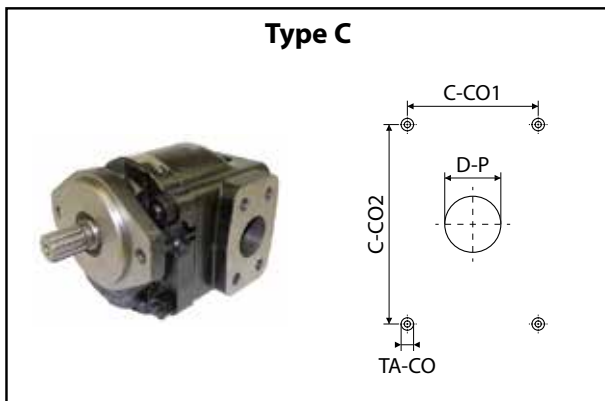
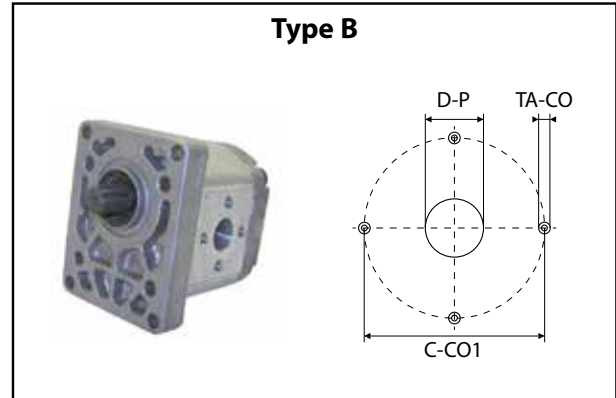
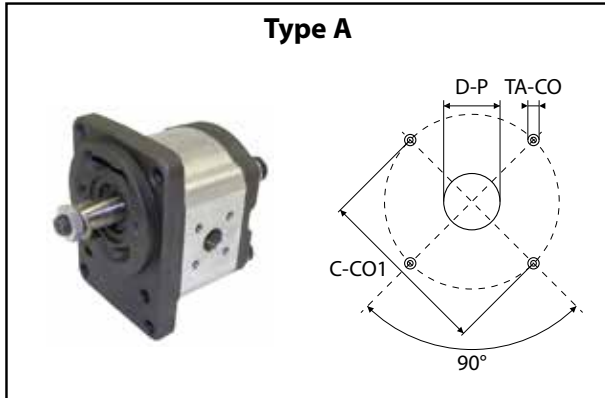



TECHNICAL DETAIL: HYDRAULIC PUMP

TYPE OF CONNECTIONS SUCTION PORT

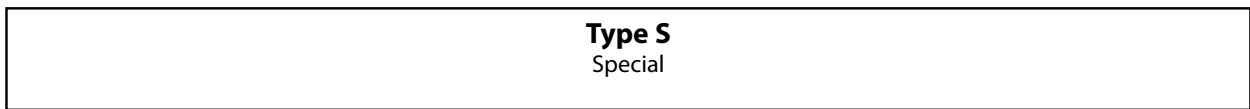
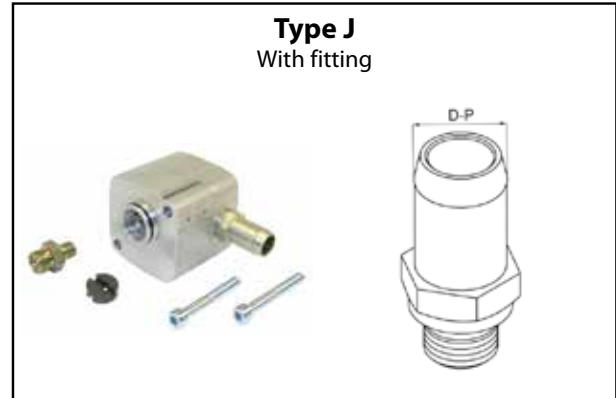
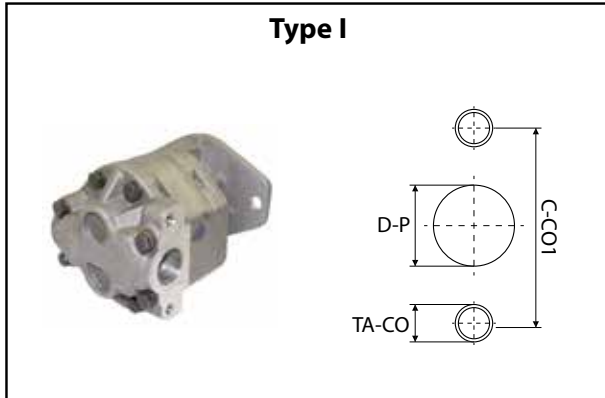

FLOW CONTROL VALVE

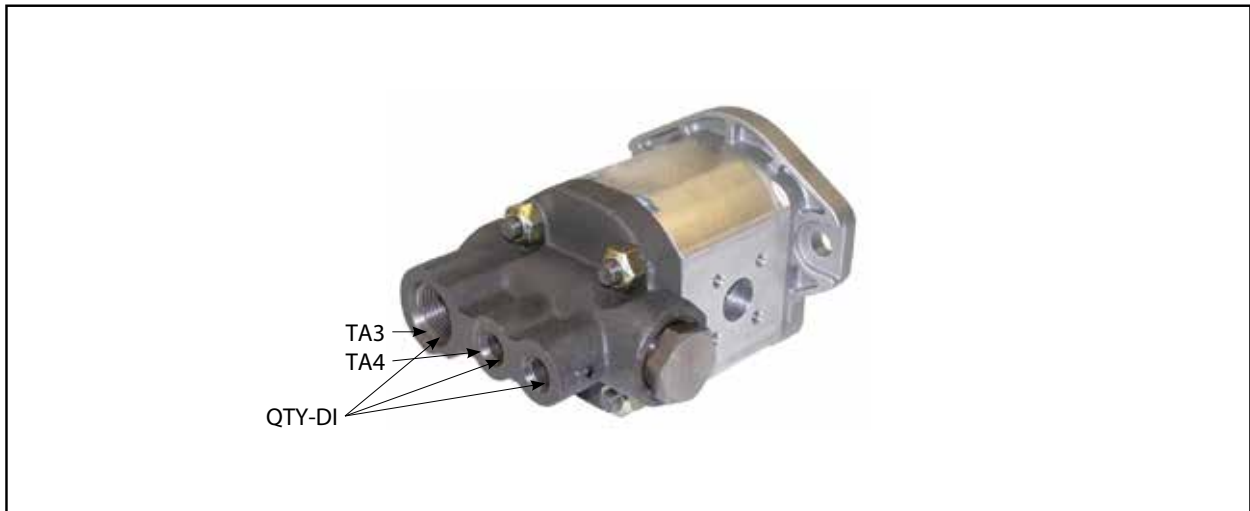

MATERIAL OF THE HOUSING

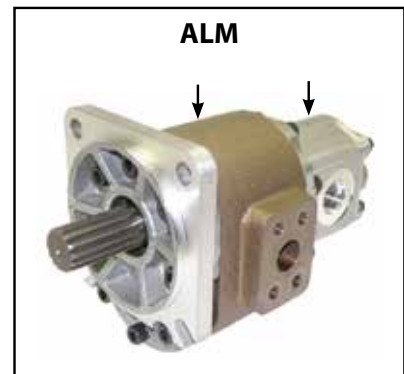
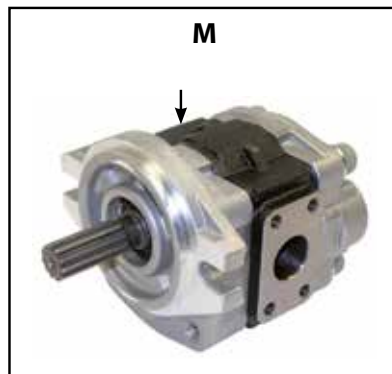



TECHNICAL DETAIL: HYDRAULIC PUMP

Groep
03-04-02-00



Gegevens klant

Type machine:

Prijsaanvraag

Serienr. machine:

Bestelling

CODE: TY-PU x QTY-EP x TY-FL x D1 x TA1 x C1 x C2 x L1 x D2 x L1 x D2 x TY-SH x L2 x D3 x QTY-SPL x W x TA2 x TAP x POS-CO1 x TY-COa x TA-COa x C-CO1a x C-CO2a x D-Pa x TA-Pa x POS-CO2 x TY-COb x TA-COb x C-CO1b x C-CO2b x D-Pb x TA-Pb x POS-CO3 x TY-COc x TA-COc x C-CO1c x C-CO2c x D-Pc x TA-Pc x POS-CO4 x TY-COd x TA-COd x C-CO1d x C-CO2d x D-Pd x TA-Pd x FL-DI x QTY-DI x TA3 x TA4 x Q x P x MAT x CPL

[Empty box for notes or additional specifications]

- TY-PU Type pomp:
 - T = tandwielpompe
 - S = schottenpompe
 - P = plunjerpompe
- QTY-EP Aantal pompelementen.
- TY-FL Type flens.
- D1 Diameter bevestigingsgaten flens (mm).
- TA1 Draadsoort bevestigingsgaten flens (mm).
- C1 Centerafstand bevestigingsgaten flens (mm).
- C2 Centerafstand bevestigingsgaten flens (mm).
- L1 Totale lengte pomp (mm).
- D2 Halsdiameter (mm).
- TY-SH Type as.
- L2 Afstand flens tot asuiteinde (mm).
- D3 Asdiameter (mm).
- QTY-SPL Aantal canneluren.
- W Breedte spie of spiegleuf (mm).
- TA2 Draadsoort (op as).

zie Engelse technische fiche !



TECHNICAL DETAIL: HYDRAULIC PUMP

- TAP Kegel 1/5 of 1/8, indien type G.
- DR Draaizin:
CW = wijzerzin
CCW = tegen wijzerzin
Bl = beide richtingen
- POS-CO1 Positie aanzuigopening 1e, alleen voor pomp type T:
F = voorkant
R = achterkant
S = zijkant
- TY-COa..... Type aansluiting aanzuigopening 1e element, alleen voor pomp type T.
- TA-COa..... Draadsoort van aanzuigopening 1e element.
- C-CO1a..... Centerafstand tussen bevestigingsgaten (mm).
- C-CO2a..... Centerafstand tussen bevestigingsgaten (mm).
- D-Pa Diameter aanzuigopening 1e element (mm).
- TA-Pa Draadsoort aanzuigopening 1e element.
- POS-CO2 Positie persopening 1e element, alleen voor pomp type T:
F = voorkant
R = achterkant
S = zijkant
- TY-COb..... Type aansluiting persopening 1e element, alleen voor pomp type T.
- TA-COb Draadsoort van persopening 1e element.
- C-CO1b Centerafstand tussen bevestigingsgaten (mm).
- C-CO2b Centerafstand tussen bevestigingsgaten (mm).
- D-Pb Diameter persopening 1e element (mm).
- TA-Pb Draadsoort persopening 1e element.
- POS-CO3 Positie aanzuigopening 2, alleen voor pomp type T:
F = voorkant
R = achterkant
S = zijkant
- TY-COc..... Type aansluiting aanzuigopening 2e element, alleen voor pomp type T.
- TA-COc..... Draadsoort van aanzuigopening 2e element.
- C-CO1c..... Centerafstand tussen bevestigingsgaten (mm).
- C-CO2c..... Centerafstand tussen bevestigingsgaten (mm).
- D-Pc Diameter aanzuigopening 2e element (mm).

zie Engelse technische fiche !



TECHNICAL DETAIL: HYDRAULIC PUMP

- TA-Pc Draadsoort aanzuigopening 2e element.
- POS-CO4 Positie persopening 2e element, alleen voor pomp type T:
F = voorkant
R = achterkant
S = zijkant
- TY-COd Type aansluiting poort persopening 2e element, alleen voor pomp type T.
- TA-COd Draadsoort van persopening 2e element.
- C-CO1d Centerafstand tussen bevestigingsgaten (mm).
- C-CO2d Centerafstand tussen bevestigingsgaten (mm).
- D-Pd Diameter persopening 2e element (mm).
- TA-Pd Draadsoort persopening 2e element.
- FL-DI Stroomverdeler aanwezig: JA/NEE.
- QTY-DI Aantal poorten van de stroomverdeler.
- TA3 Draadsoort grootste aansluiting stroomverdeler.
- TA4 Draadsoort 2de aansluiting stroomverdeler.
- Q Capaciteit (cc/rev).
- P Maximum druk van de pompbar.
- MAT Materiaal van de behuizing:
AL = aluminium
M = metaal
ALM = aluminium en metaal
- CPL Meenemer aanwezig: JA/NEE.

TYPE POMP

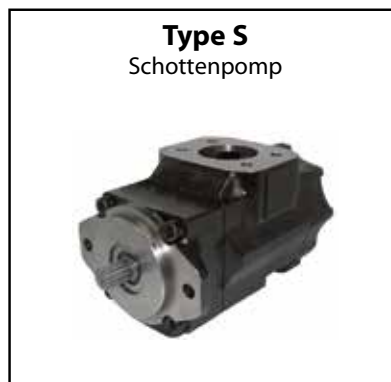

zie Engelse technische fiche !



TECHNICAL DETAIL: HYDRAULIC PUMP

Groupe
03-04-02-00

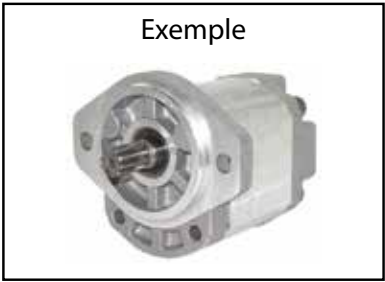

Données client

Type machine :

Demande de prix

No. série machine :

Commande

CODE : TY-PU x QTY-EP x TY-FL x D1 x TA1 x C1 x C2 x L1 x D2 x L1 x D2 x TY-SH x L2 x D3 x QTY-SPL x W x TA2 x TAP x POS-CO1 x TY-COa x TA-COa x C-CO1a x C-CO2a x D-Pa x TA-Pa x POS-CO2 x TY-COb x TA-COb x C-CO1b x C-CO2b x D-Pb x TA-Pb x POS-CO3 x TY-COc x TA-COc x C-CO1c x C-CO2c x D-Pc x TA-Pc x POS-CO4 x TY-COd x TA-COd x C-CO1d x C-CO2d x D-Pd x TA-Pd x FL-DI x QTY-DI x TA3 x TA4 x Q x P x MAT x CPL



- TY-PU Type de pompe :
 - T = pompe à engrenages
 - S = pompe à palettes
 - P = pompe à pistons
- QTY-EP Nombre d'éléments de pompe.
- TY-FL Type de bride.
- D1 Diamètre des trous de fixation de bride (mm).
- TA1 Type de filetage des trous de fixation de bride (mm).
- C1 Entraxe des trous de fixation de bride (mm).
- C2 Entraxe des trous de fixation de bride (mm).
- L1 Longueur totale de la pompe (mm).
- D2 Diamètre du col (mm).
- TY-SH Type d'arbre.
- L2 Distance de la bride jusqu'au bout d'arbre (mm).
- D3 Diamètre de l'arbre (mm).
- QTY-SPL Nombre de cannelures.
- W Largeur de (rainure de) clavette (mm).
- TA2 Type de filetage (sur arbre).
- TAP Cône 1/5 of 1/8, si type G.

voir la fiche technique en Anglais.



TECHNICAL DETAIL: HYDRAULIC PUMP

- DR Sens de rotation :
CW = sens horaire
CCW = sens antihoraire
BI = les deux sens
- POS-CO1 Position de l'orifice d'aspiration 1er element, seulement pour pompes type T :
F = devant
R = derrière
S = côté
- TY-COa..... Type de raccordement de l'orifice d'aspiration 1er element, seulement pour pompes type T.
- TA-COa..... Type de filetage raccordement aspiration 1er élément.
- C-CO1a..... Entraxe entre les trous de fixation (mm).
- C-CO2a..... Entraxe entre les trous de fixation (mm).
- D-Pa Diamètre aspiration 1er élément (mm).
- TA-Pa Type de filetage aspiration 1er élément.
- POS-CO2 Position pression 1er élément, seulement pour pompes type T :
F = devant
R = derrière
S = côté
- TY-COb..... Type de raccordement pression 1er élément, seulement pour pompes type T.
- TA-COb Type de filetage du raccordement de l'orifice d'aspiration 1er élément.
- C-CO1b Entraxe entre les trous de fixation (mm).
- C-CO2b Entraxe entre les trous de fixation (mm).
- D-Pb Diamètre de l'orifice d'aspiration 1er élément (mm).
- TA-Pb Type de filetage pression 1er élément.
- POS-CO3 Position de l'orifice de pression 2ème element, seulement pour pompes type T :
F = devant
R = derrière
S = côté
- TY-COc..... Type de raccordement de l'orifice de pression 2ème element, seulement pour pompes type T.
- TA-COc..... Type de filetage du raccordement de l'orifice de pression 2ème élément.
- C-CO1c..... Entraxe entre les trous de fixation (mm).
- C-CO2c..... Entraxe entre les trous de fixation (mm).

voir la fiche technique en Anglais.



TECHNICAL DETAIL: HYDRAULIC PUMP

- D-Pc Diamètre de l'orifice d'aspiration 2ème élément.
- TA-Pc Type de filetage du raccordement de l'orifice d'aspiration 2ème élément.
- POS-CO4 Position de l'orifice de pression 2ème élément, seulement pour pompes type T :
F = devant
R = derrière
S = côté
- TY-COd Type de raccordement de l'orifice de pression 2ème élément, seulement pour pompes type T.
- TA-COd Type de filetage du raccordement de l'orifice de pression 2ème élément.
- C-CO1d Entraxe entre les trous de fixation (mm).
- C-CO2d Entraxe entre les trous de fixation (mm).
- D-Pd Diamètre de l'orifice de pression 2ème élément (mm).
- TA-Pd Type de filetage de l'orifice de pression 2ème élément.
- FL-DI Distributeur d'allumage présent : OUI/NON.
- QTY-DI Nombre de sorties du distributeur d'allumage.
- TA3 Type de filetage plug grand raccordement du distributeur d'allumage.
- TA4 Type de filetage 2ème raccordement du distributeur d'allumage.
- Q Capacité (cm³/rot).
- P Pression maximale de la pompe.
- MAT Matière du boîtier :
AL = aluminium
M = métal
ALM = aluminium et métal
- CPL Accouplement present : OUI/NON.

TYPE DE POMPE

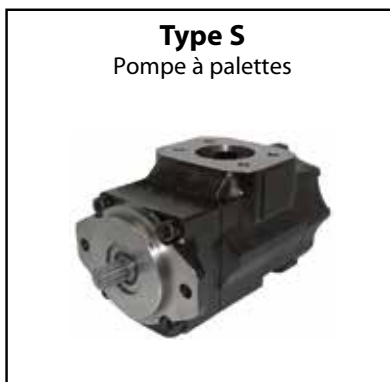

voir la fiche technique en Anglais.



TECHNICAL DETAIL: HYDRAULIC PUMP

Gruppe
03-04-02-00



Kundendaten

Maschinentyp:

Preis Anfrage

Serien-Nr. Maschine:

Bestellung

CODE: TY-PU x QTY-EP x TY-FL x D1 x TA1 x C1 x C2 x L1 x D2 x L1 x D2 x TY-SH x L2 x D3 x QTY-SPL x W x TA2 x TAP x POS-CO1 x TY-COa x TA-COa x C-CO1a x C-CO2a x D-Pa x TA-Pa x POS-CO2 x TY-COb x TA-COb x C-CO1b x C-CO2b x D-Pb x TA-Pb x POS-CO3 x TY-COc x TA-COc x C-CO1c x C-CO2c x D-Pc x TA-Pc x POS-CO4 x TY-COd x TA-COd x C-CO1d x C-CO2d x D-Pd x TA-Pd x FL-DI x QTY-DI x TA3 x TA4 x Q x P x MAT x CPL



- TY-PU Pumpentyp:
 - T = Zahnradpumpe
 - S = Flügelradpumpe
 - P = Kolbenpumpe
- QTY-EP Anzahl Pumpenelemente.
- TY-FL Typ Flansch.
- D1 Durchmesser Gewinde- Montagebohrungen Flansch (mm).
- TA1 Gewindetyp- Montagebohrungen Flansch (mm).
- C1 Centerabstand Gewinde- Montagebohrungen Flansch (mm).
- C2 Centerabstand Gewinde- Montagebohrungen Flansch (mm).
- L1 Gesamtlänge Pumpe (mm).
- D2 Halsdurchmesser (mm).
- TY-SH Achsentyp.
- L2 Abstand Ende - Flansch (mm).
- D3 Achsendurchmesser (mm).
- QTY-SPL Anzahl Kanäle.
- W Nutbreite oder Nutschlitz (mm).
- TA2 Gewinde (auf Achse).

Siehe technische Datenblätter auf Englisch.



TECHNICAL DETAIL: HYDRAULIC PUMP

- TAP Kegel 1/5 oder 1/8, wenn Typ G.
- DR Drehrichtung:
CW = Uhrzeigersinn
CCW = Gegen Uhrzeigersinn
BI = Beide Richtungen
- POS-CO1 Position Ansaug 1, alleine für Pumpentyp T:
F = Vorderseite
R = Rückseite
S = Seite
- TY-COa Anschlußtyp A, Ansaugeneingang 1, alleine für Pumpentyp T.
- TA-COa Gewindetyp- Montagebohrungen.
- C-CO1a Centerabstand zwischen Gewinde- Montagebohrungen (mm).
- C-CO2a Centerabstand zwischen Gewinde- Montagebohrungen (mm).
- D-Pa Durchmesser Ansaugenelement 1 (mm).
- TA-Pa Gewindetyp Ansaugenelement 1.
- POS-CO2 Position Druck 1, alleine für Pumpentyp T:
F = Vorderseite
R = Rückseite
S = Seite
- TY-COb Anschlußtyp Eingang Druck 1, alleine für Pumpentyp T.
- TA-COb Gewindetyp- Montagebohrungen.
- C-CO1b Centerabstand zwischen Gewinde- Montagebohrungen (mm).
- C-CO2b Centerabstand zwischen Gewinde- Montagebohrungen (mm).
- D-Pb Durchmesser Druckelement 1 (mm).
- TA-Pb Gewindetyp Druckelement 1.
- POS-CO3 Position Ansaug 2, alleine für Pumpentyp T:
F = Vorderseite
R = Rückseite
S = Seite
- TY-COc Anschlußtyp Eingang Ansaug 2, alleine für Pumpentyp T.
- TA-COc Gewindetyp- Montagebohrungen.
- C-CO1c Centerabstand zwischen Gewinde - Montagebohrungen (mm).
- C-CO2c Centerabstand zwischen Gewinde - Montagebohrungen (mm).
- D-Pc Durchmesser Ansaugenelement 2 (mm).

Siehe technische Datenblätter auf Englisch.



TECHNICAL DETAIL: HYDRAULIC PUMP

- TA-Pc Gewindetyp Ansaugelement 2.
- POS-CO4 Position Druck 2, alleine für Pumpentyp T:
F = Vorderseite
R = Rückseite
S = Seite
- TY-COd Anschlusstyp Druckeingang 2, alleine für Pumpentyp T.
- TA-COd Gewindetyp- Montagebohrungen.
- C-CO1d Centerabstand zwischen Gewinde - Montagebohrungen (mm).
- C-CO2d Centerabstand zwischen Gewinde - Montagebohrungen (mm).
- D-Pd Durchmesser Druckelement 2 (mm).
- TA-Pd Gewindetyp Druckelement 2.
- FL-DI Mengenteiler vorhanden: JA/NEIN.
- QTY-DI Anzahl Eingänge vom Mengenteiler.
- TA3 Gewindetyp größter Anschluss Mengenteiler.
- TA4 Gewindetyp 2ter Anschluß vom Mengenteiler.
- Q Kapazität (cc/rev).
- P Maximaler Druck von der Pumpe.
- MAT Material vom Gehäuse:
AL = Aluminium
M = Metall
ALM = Aluminium und Metall
- CPL Mitnehmer anwesend: JA/NEIN.

PUMPENTYP

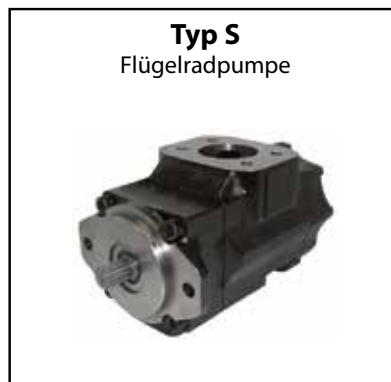

Siehe technische Datenblätter auf Englisch.



2

STEERING UNITS



STEERING UNITS



Search [Info] [Recent Items]

MyPartsFinder > [Home](#) > [MyPartsFinder](#) > Search > Vehicle > **507322** > BAUTZ, EXEL, ABENA > 2009FA, East Heavy (Motor), AUTOMATIC

View selected model details

Vehicle	Transmission
Model: 135, 154H	Type: AUTOMATIC
Serial prefix: 0002	
Serial from: A11213	
Serial to: 270000	
Source: East Heavy (Data)	

Make changes to non-specified sections

Select articles from the tree structure for your specified machine.

- ENGINE
- COOLING
- DRIVE SHAFT
- BLANK TRUCK
- EXHAUST
- CO-AXIAL
- FLY WHEEL
- CRANK
- PUMP
- MICROSWITCH
- CONNECTION
- LEVERS
- STEERING**
- WHEELS

Specifications

Part number	Part description	Quantity	Extra info
580340	KIT REPAIR, STEERING CYLINDER	1	
9570223	KIT SEAL O-RING GOVERNOR STEERING	1	
9820450	TRUCKLE LH, STEERING ASSEMBLY	1	
9849390	TRUCKLE RH, STEERING ASSEMBLY	1	
9030730	LINK, STEERING CYLINDER TO KNIFE	2	
9850467	DRIVE SHAFT ASSEMBLY	1	
9545414	PIN, STEER LINK STEERING CYLINDER TO KNIFE	4	
9530761	SEAL, INTER, STEER WHEEL, HUB	2	
4011830	SEAL, STEER KNUIFE PIVOT	1	
2245422	WASHER, CRANK PIN, CRANK	2	



Please give us full details of the steering unit make or complete machine or steering unit details.

We can offer you the brands below:
Danfoss, Eaton, M+S, Ognibene, Parker



TECHNICAL DETAIL: STEERING UNIT

Group
12-01-03-00

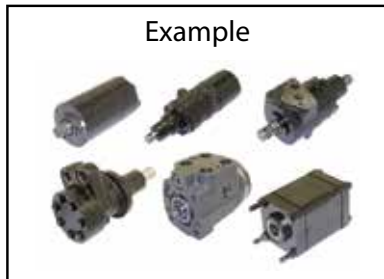

Customer details

Type machine:

Price inquiry

Serial n° machine:

Order

CODE: TY-ORB x L1 x B x H x D1 x L2 x AC x D2 x AT-AS x D3 x TA1 x Pm1 x Pi1 x TA2 x Pm2 x Pi2 x TA3 x Pm3 x Pi3 x TA4 x Pm4 x Pi4 x C x TA5 x Pm5 x Pi5 x MERK x G-NR

TY-ORB..... Type of orbitrol, see types.
L1..... Length of the orbitrol, see figure.
B..... Width, see figure.
H..... Height, see figure.
D1 Diameter, see figure.
L2..... Length, see figure.
AC Number of splines, if present.
D2 Diameter, see figure.
AT-AS Number of connections.
D3 Largest diameter connections, if holes.
TA1 Thread type of connections.
ATTENTION: if different thread TA1 is the largest.
Pm1..... Pitch metric.
Pi1 Pitch per inch.
TA2 Second thread type connections, if present.
Pm2..... Pitch metric.
Pi2 Pitch per inch.
TA3 Third thread type connections, if present.
Pm3..... Pitch metric.



TECHNICAL DETAIL: STEERING UNIT

- Pi3 Pitch per inch.
- TA4 Mounting thread type of the orbitrol.
- Pm4..... Pitch metric.
- Pi4 Pitch per inch.
- C..... Centre distance of the mounting thread.
- TA5 Mounting thread type of the valve block.
- Pm5..... Pitch metric.
- Pi5 Pitch per inch.
- MERK Brand of the orbitrol.
- G-NR..... Casting number.

TYPES

Type A
Connection at the side

AT-A5
TA1 → TA3
(from large to small)

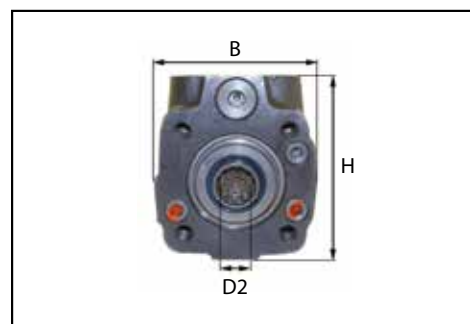
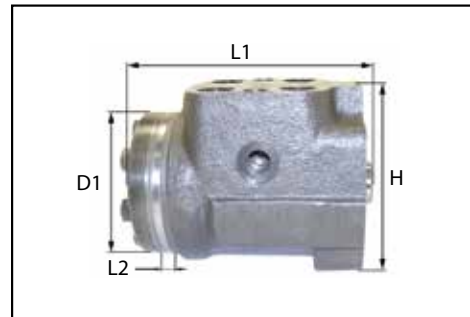
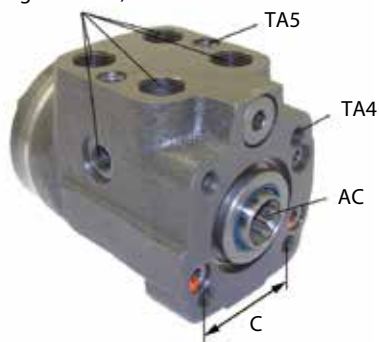



TECHNICAL DETAIL: STEERING UNIT

TYPES

Type A

Connection at the side

AT-AS
TA1 → TA3
(from large to small)

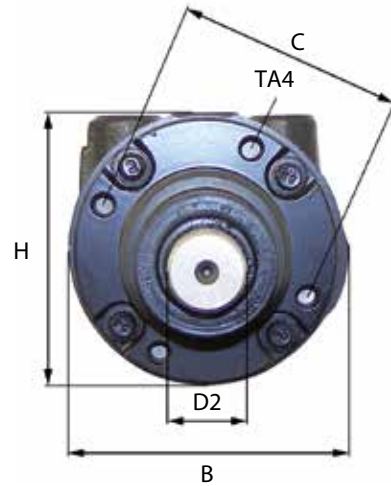
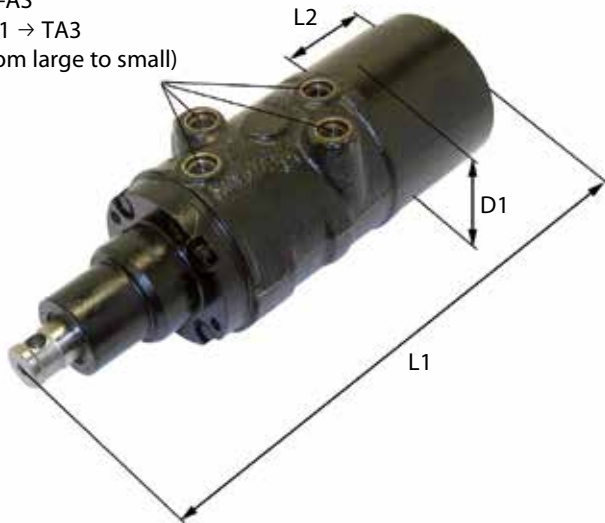

Type A

Connection at the side

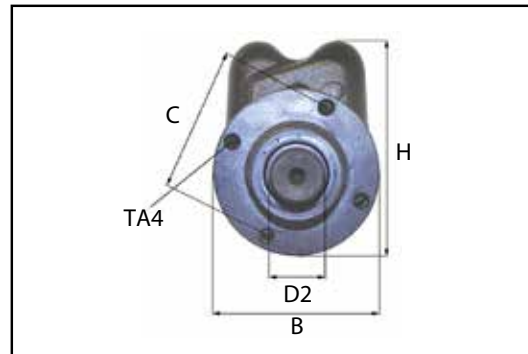
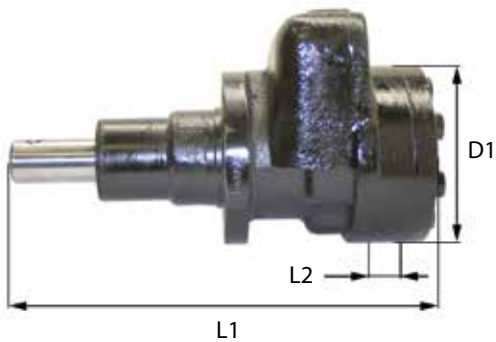

AT-AS
TA1 → TA2
(from large to small)





TECHNICAL DETAIL: STEERING UNIT

TYPES

Type B
Connection at the bottom

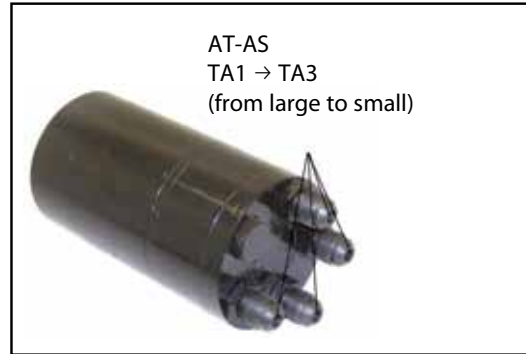
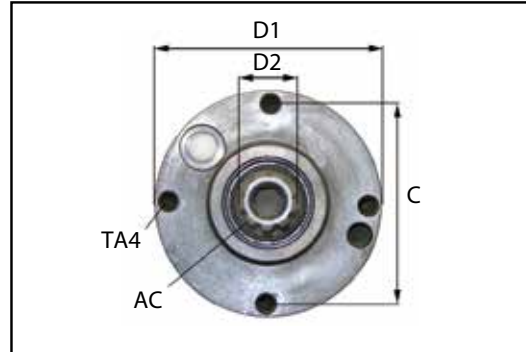
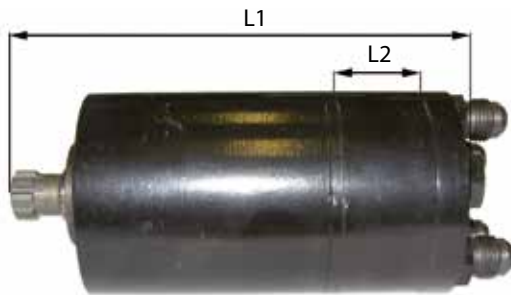

Type B
Connection at the bottom

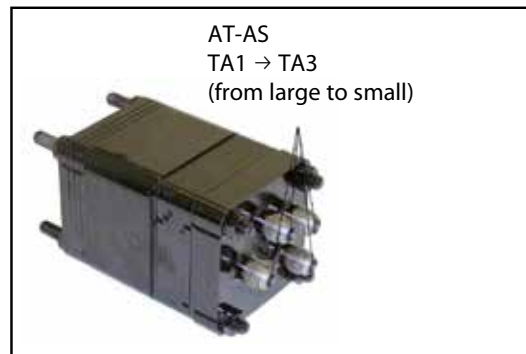
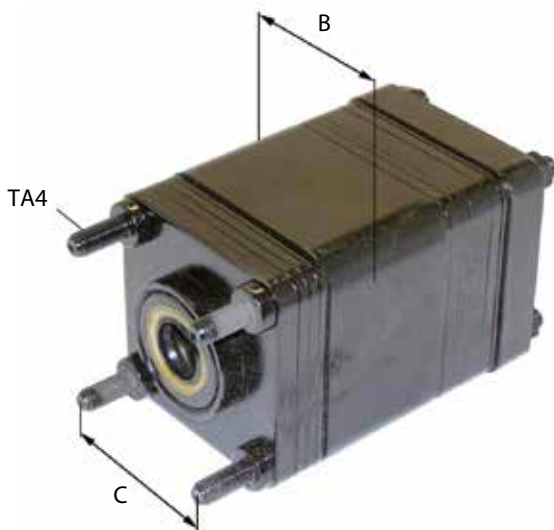



TECHNICAL DETAIL: STEERING UNIT

TYPES

Type C
Moment amplifier

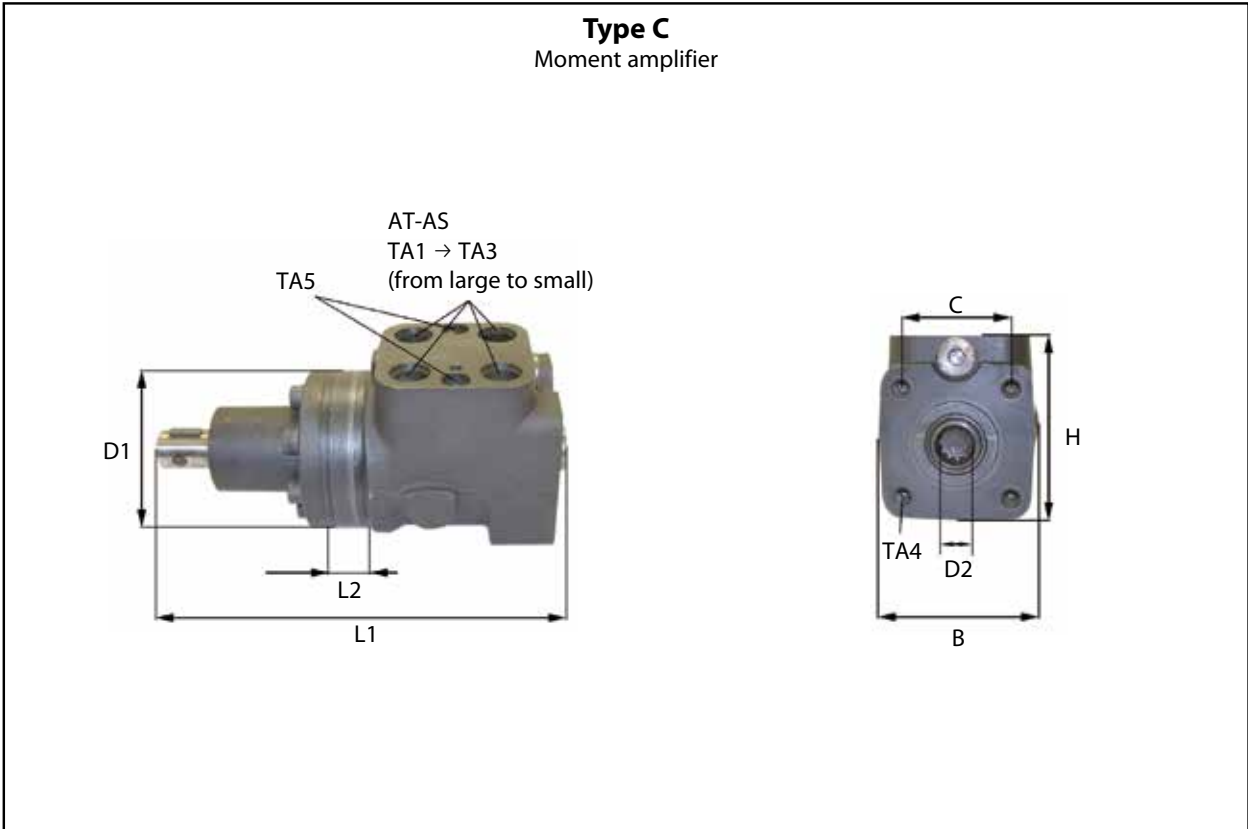

Type C
Moment amplifier

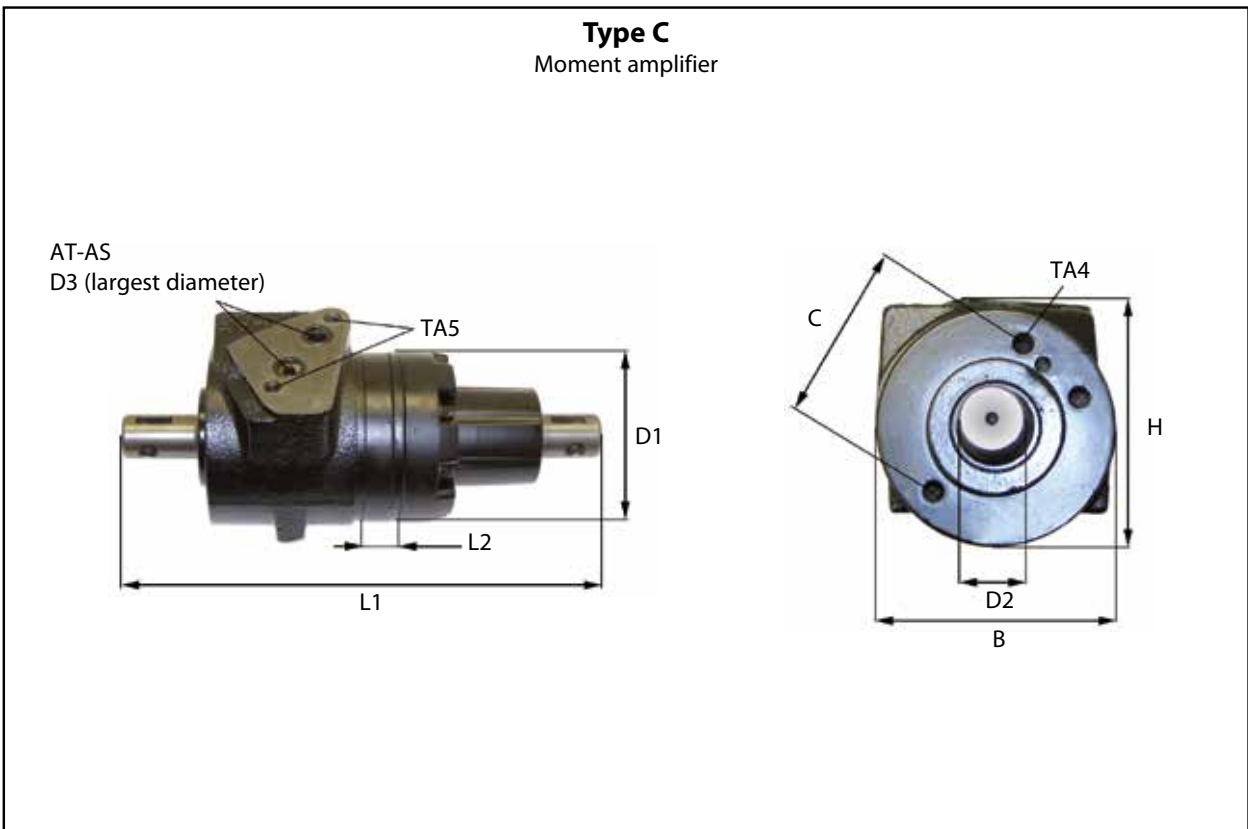



TECHNICAL DETAIL: STEERING UNIT

Groep
12-01-03-00



Gegevens klant

Type machine:

Prijsaanvraag

Serienr. machine:

Bestelling

CODE: TY-ORB x L1 x B x H x D1 x L2 x AC x D2 x AT-AS x D3 x TA1 x Pm1 x Pi1 x TA2 x Pm2 x Pi2 x TA3 x Pm3 x Pi3 x TA4 x Pm4 x Pi4 x C x TA5 x Pm5 x Pi5 x MERK x G-NR



- TY-ORB..... Type orbitrol, zie types.
- L1..... Lengte van de orbitrol, zie figuur.
- B..... Breedte, zie figuur.
- H..... Hoogte, zie figuur.
- D1 Diameter, zie figuur.
- L2..... Lengte, zie figuur.
- AC Aantal kanaluren, indien aanwezig.
- D2 Diameter, zie figuur.
- AT-AS Aantal aansluitingen.
- D3 Grootste diameter aansluitingen, indien gaten.
- TA1 Draadsoort aansluitingen.
LET OP: indien verschillende schroefdraad TA1 is de grootste.
- Pm1..... Pas metrisch.
- Pi1 Pas per duim.
- TA2 Tweede draadsoort aansluitingen, indien aanwezig.
- Pm2..... Pas metrisch.
- Pi2 Pas per duim.
- TA3 Derde draadsoort aansluitingen, indien aanwezig.
- Pm3..... Pas metrisch.

zie Engelse technische fiche !



TECHNICAL DETAIL: STEERING UNIT



- Pi3 Pas per duim.
- TA4 Montage draadsoort van de orbitrol.
- Pm4..... Pas metrisch.
- Pi4 Pas per duim.
- C..... Centerafstand van de montage schroefdraad.
- TA5 Montage draadsoort van het ventielblok.
- Pm5..... Pas metrisch.
- Pi5 Pas per duim.
- MERK Merk van het orbitrol.
- G-NR..... Gietnummer.

TYPES

Type A

Aansluiting aan de zijkant

AT-AS
TA1 → TA3
(van groot naar klein)

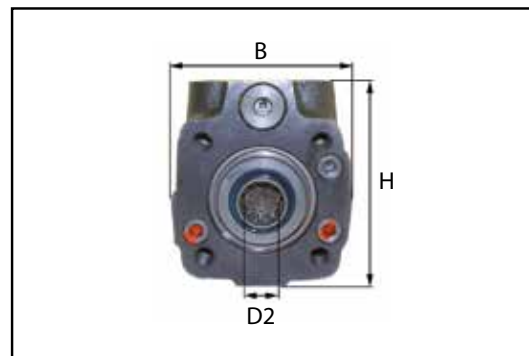
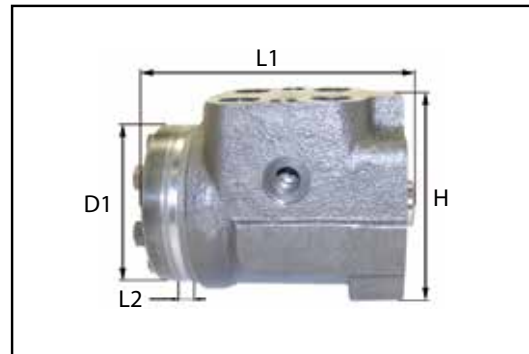
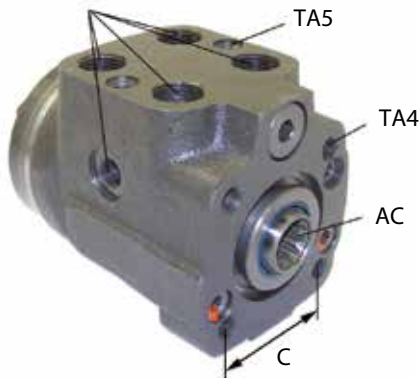

zie Engelse technische fiche !



TECHNICAL DETAIL: STEERING UNIT

Groupe
12-01-03-00

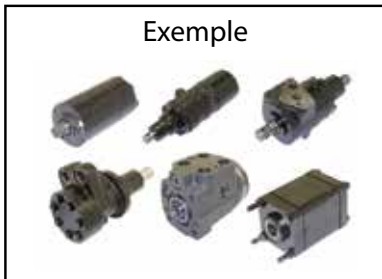

Données client

Type machine :

Demande de prix

No. série machine :

Commande

CODE : TY-ORB x L1 x B x H x D1 x L2 x AC x D2 x AT-AS x D3 x TA1 x Pm1 x Pi1 x TA2 x Pm2 x
 Pi2 x TA3 x Pm3 x Pi3 x TA4 x Pm4 x Pi4 x C x TA5 x Pm5 x Pi5 x MERK x G-NR

- TY-ORB..... Type d'orbitrol, voir types.
- L1..... Longueur de l'orbitrol, voir figures.
- B..... Largeur, voir figures.
- H..... Hauteur, voir figures.
- D1 Diamètre, voir figures.
- L2..... Longueur, voir figures.
- AC Nombre de cannelures, si présentes.
- D2 Diamètre, voir figures.
- AT-AS Nombre de connexions.
- D3 Si les connexions sont des trous, prendre le plus grand diamètre pour cette mesure.
- TA1 Filetage des connexions.
ATTENTION : s'il y a plusieurs filetages différents TA1 est le plus grand.
- Pm1..... Pas métrique.
- Pi1 Pas en pouce.
- TA2 Deuxième filetage des connexions, si présent.
- Pm2..... Pas métrique.
- Pi2 Pas en pouce.
- TA3 Troisième filetage des connexions, si présent.

voir la fiche technique en Anglais.



TECHNICAL DETAIL: STEERING UNIT

- Pm3..... Pas métrique.
- Pi3 Pas en pouce.
- TA4 Filetage pour montage de l'orbitrol.
- Pm4..... Pas métrique.
- Pi4 Pas en pouce.
- C..... Entraxe du filetage pour montage de l'orbitrol.
- TA5 Filetage pour montage de la valve.
- Pm5..... Pas métrique.
- Pi5 Pas en pouce.
- MERK Marque de l'orbitrol.
- G-NR..... Numéro de fonte.

TYPES

Type A

Connexions sur le côté

AT-AS
TA1 → TA3
(du plus grand au plus petit)

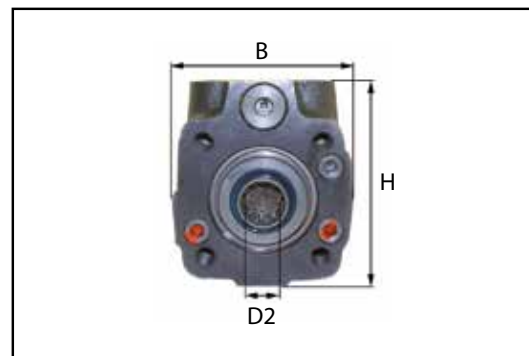
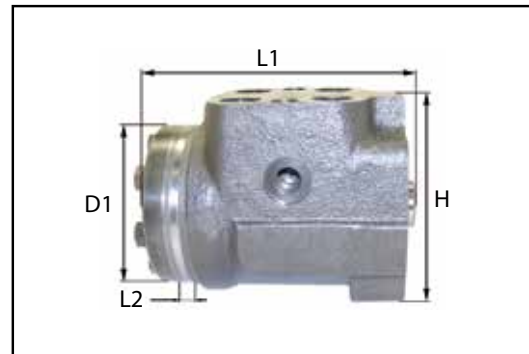
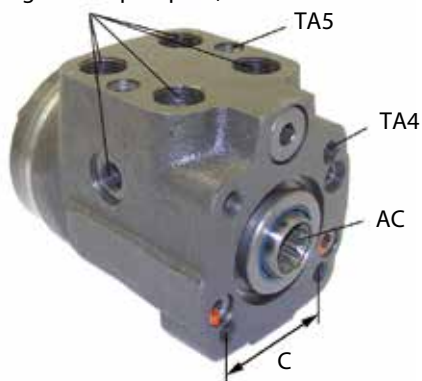

voir la fiche technique en Anglais.



TECHNICAL DETAIL: STEERING UNIT

Gruppe
12-01-03-00



Kundendaten

Maschinentyp:
 Serien-Nr. Maschine:

Preis Anfrage
 Bestellung

CODE: TY-ORB x L1 x B x H x D1 x L2 x AC x D2 x AT-AS x D3 x TA1 x Pm1 x Pi1 x TA2 x Pm2 x Pi2 x TA3 x Pm3 x Pi3 x TA4 x Pm4 x Pi4 x C x TA5 x Pm5 x Pi5 x MERK x G-NR

- TY-ORB..... Typ Orbitrol, siehe Typen.
- L1..... Länge vom Orbitrol, Siehe Bild.
- B..... Breite, siehe Bild.
- H..... Höhe, siehe Bild.
- D1 Durchmesser, siehe Bild.
- L2..... Länge, siehe Bild.
- AC Anzahl Rillen, wenn vorhanden.
- D2 Durchmesser, siehe Bild.
- AT-AS Anzahl Anschlüsse.
- D3 Größter Durchmesser der Anschlüsse, einschl. Löcher.
- TA1 Kabelart- Anschlüsse, Beachten Sie die verschiedenen Gewinde, TA1 ist das Größte.
- Pm1..... Paß metrisch.
- Pi1 Paß geschätzt.
- TA2 Zweite Kabel- Anschlüsse, wenn vorhanden.
- Pm2..... Paß metrisch.
- Pi2 Paß geschätzt.
- TA3 Dritte Kabel-Anschlüsse, wenn vorhanden.
- Pm3..... Paß metrisch.

Siehe technische Datenblätter auf Englisch.



TECHNICAL DETAIL: STEERING UNIT

- Pi3 Paß geschätzt.
- TA4 Montage Kabelart vom Orbitrol.
- Pm4..... Paß metrisch.
- Pi4 Paß geschätzt.
- C..... Mittenabstand vom Montage Gewinde.
- TA5 Montage Kabelart vom Ventilblock.
- Pm5..... Paß metrisch.
- Pi5 Paß geschätzt.
- MERK Marke vom Orbitrol.
- G-NR..... Gießnummer.

TYPEN

Typ A

Anschluss an der Seite

AT-AS
TA1 → TA3
(von Groß nach klein)

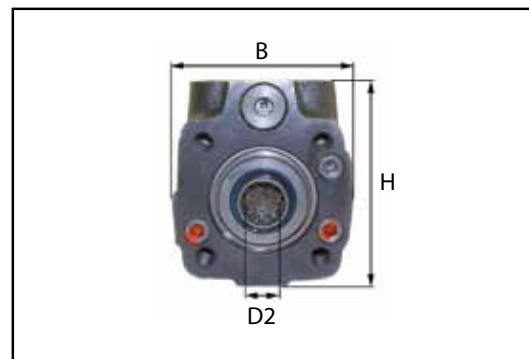
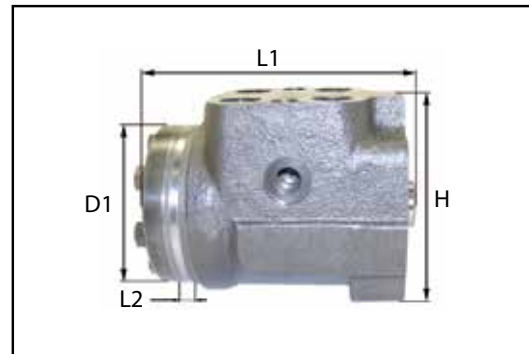
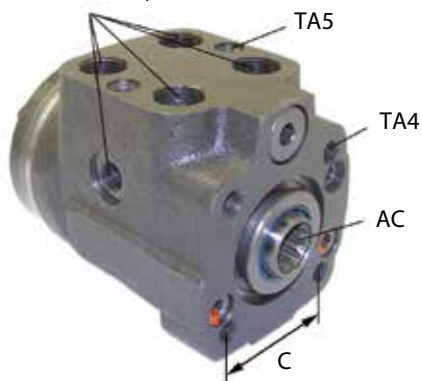

Siehe technische Datenblätter auf Englisch.



3

HYDRAULIC MOTORS



HYDRAULIC MOTORS



We can offer you the brands below:

Danfoss, Eaton, Linde-Hydraulics, Parker, Poclain, Rexroth

Please give us full details of the hydraulic motor, complete machine.



TECHNICAL DETAIL: HYDRAULIC MOTOR

Group
03-11-00-00



Customer details

Type machine:

Price inquiry

Serial n° machine:

Order

CODE: POS-AS x L1 x L2 x D1 x TY-FL x D2 x AT-GA x D3 x TA1 x Pm1 x Pi1 x C x TY-AS x L3 x D4 x AC x B x TA2 x Pm2 x Pi2 x AT-AS x TA3 x Pm3 x Pi3 x TA4 x Pm4 x Pi4 x D5 x TA5 x Pm5 x Pi5 x MERK

- POS-AS. Type of hydraulic motor, see figures.
- L1. Length of the hydraulic motor, see figure.
- L2. Length, see figure.
- D1 Diameter, see figure.
- TY-FL. Type of flange, see figures.
- D2 Neck diameter, see figure.
- AT-GA. Number of mounting holes in the flange.
- D3 Diameter of mounting holes, see figure.
- TA1 Thread type, see figures.
- Pm1. Pitch metric.
- Pi1 Pitch imperial.
- C. Centre distance between farthest mounting holes, see figure.
- TY-AS Type of shaft, see figures.
- L3. Distance, see figure.
- D4 Shaft diameter, see figure.
- AC Number of splines.
- B. Key width or keyway, see figures.
- TA2 Thread type, see figures.



TECHNICAL DETAIL: HYDRAULIC MOTOR



- Pm2..... Pitch metric.
- Pi2 Pitch imperial.
- AT-AS Number of connections.
- TA3 Thread type connections. If different thread types, TA3 is the largest.
- Pm3..... Pitch metric.
- Pi3 Pitch imperial.
- TA4 Second thread type connections, if present.
- Pm4..... Pitch metric.
- Pi4 Pitch imperial.
- D5 Connection diameter, if present.
- TA5 Mounting thread type.
- Pm5..... Pitch metric.
- Pi5 Pitch imperial.
- MERK Make of the hydraulic motor.



TECHNICAL DETAIL: HYDRAULIC MOTOR

POSITION CONNECTIONS

Position A
Connections on the top

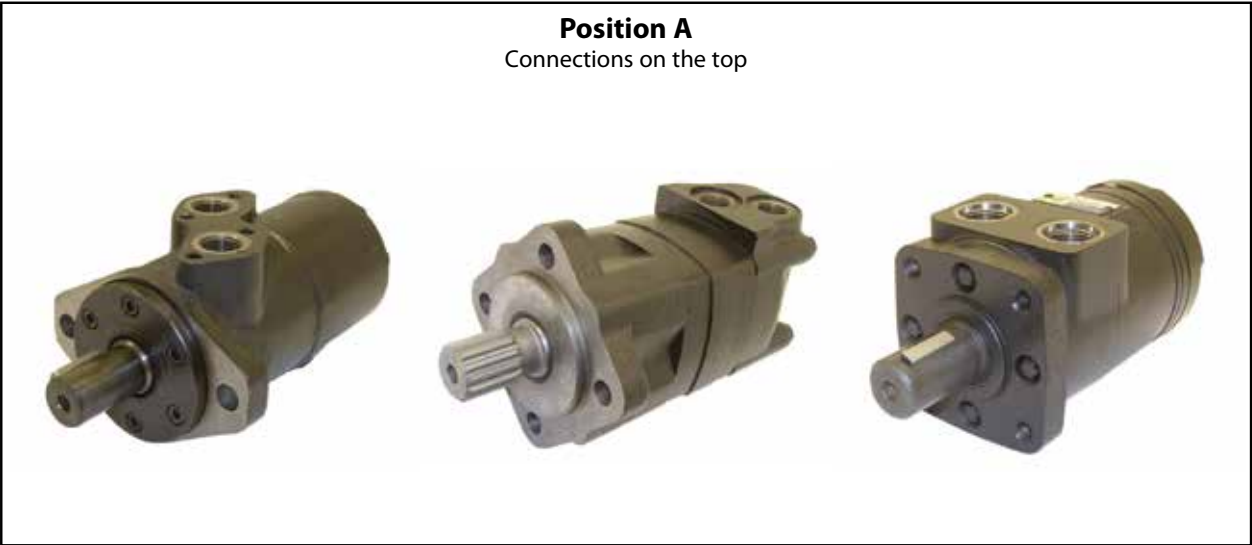

Position B
Connections on the rear

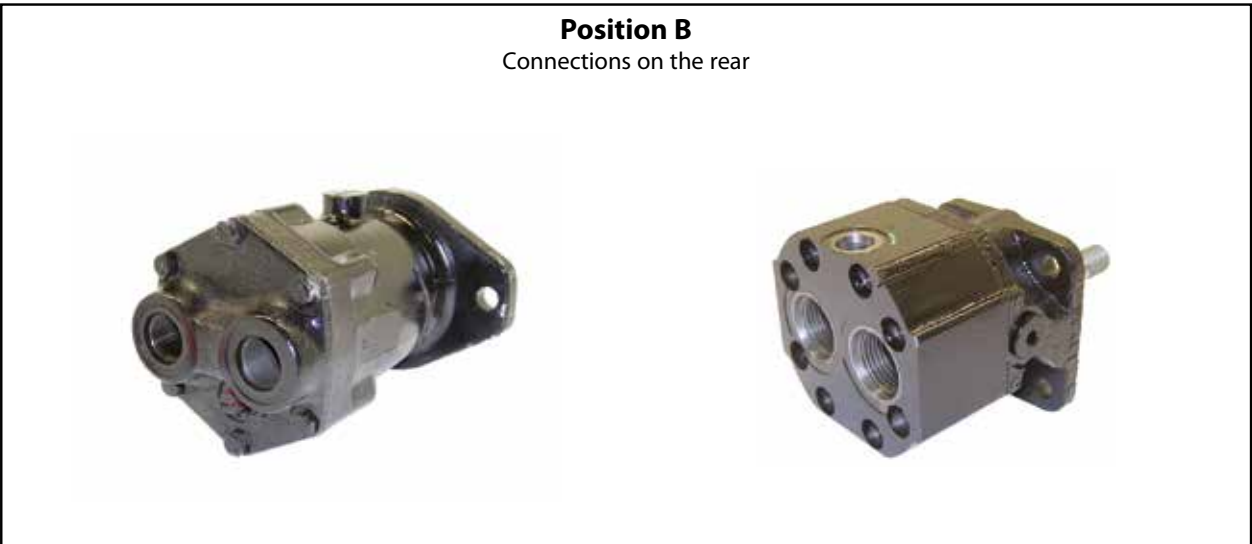

Position C
Connections on the side

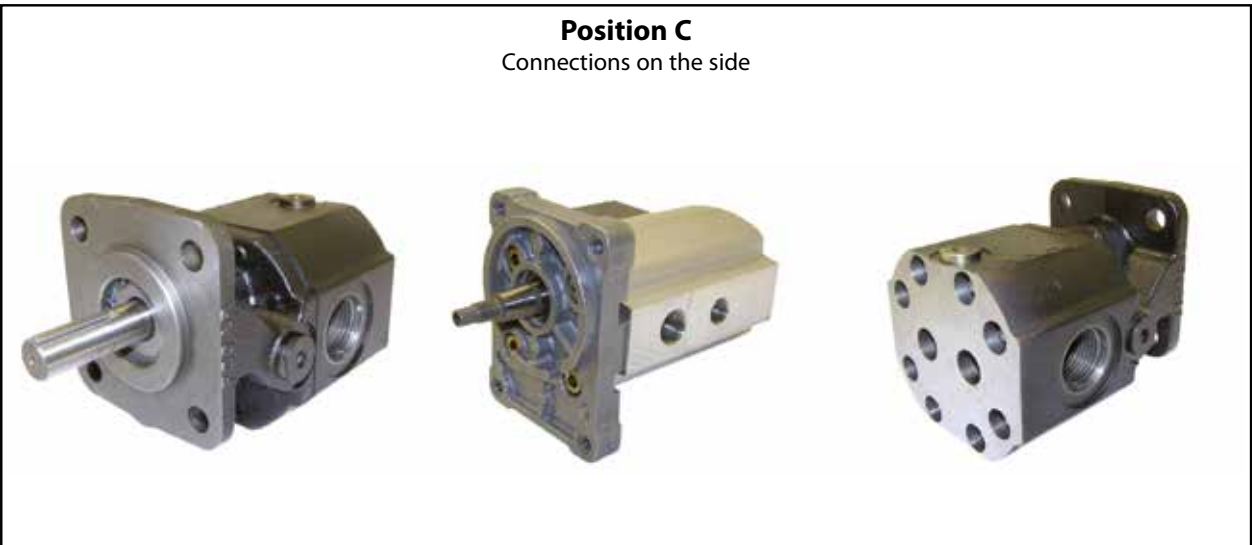



TECHNICAL DETAIL: HYDRAULIC MOTOR

DIMENSIONS

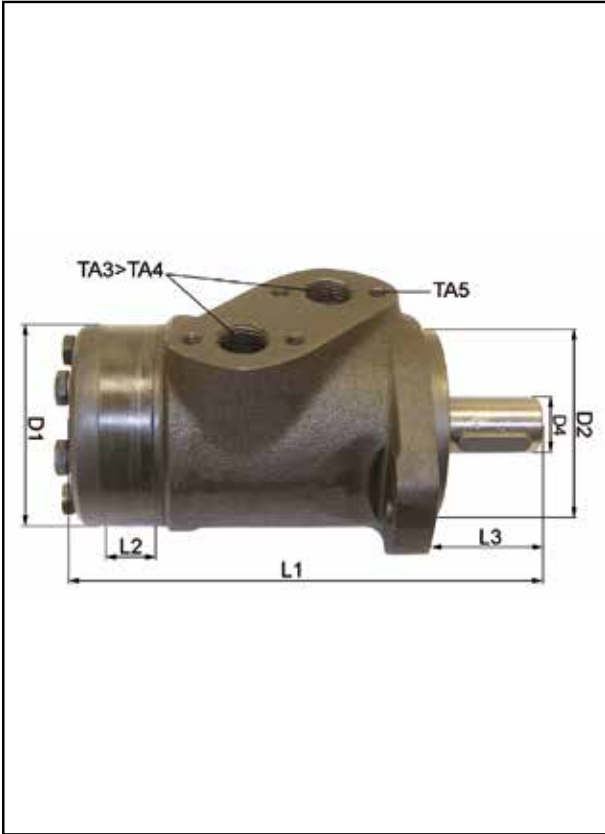



TECHNICAL DETAIL: HYDRAULIC MOTOR

TYPE OF FLANGE

Type A

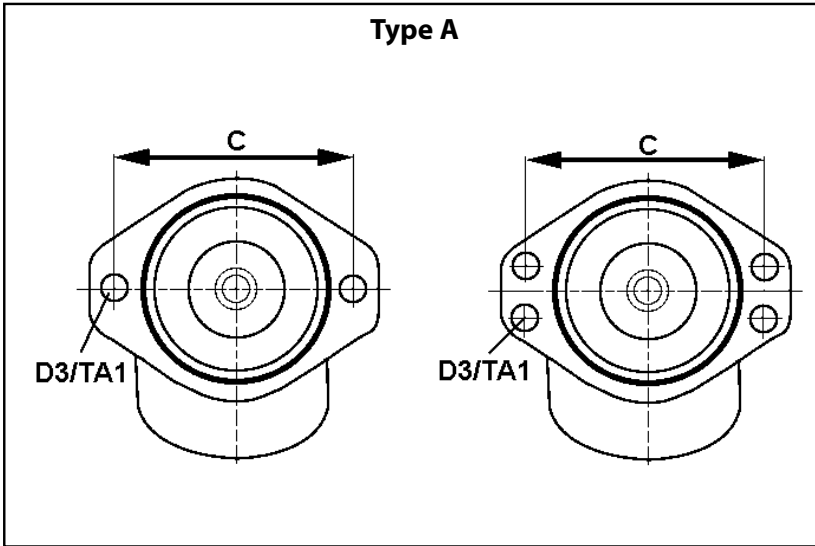

Type B

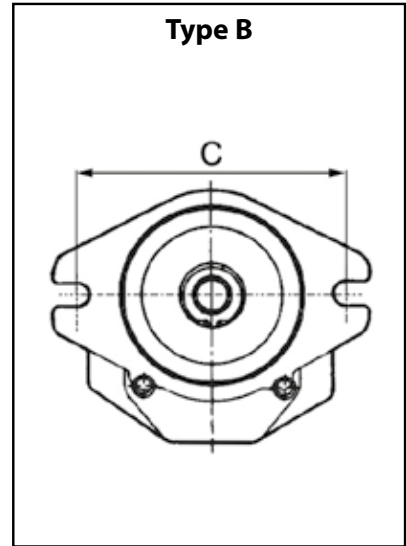

Type C

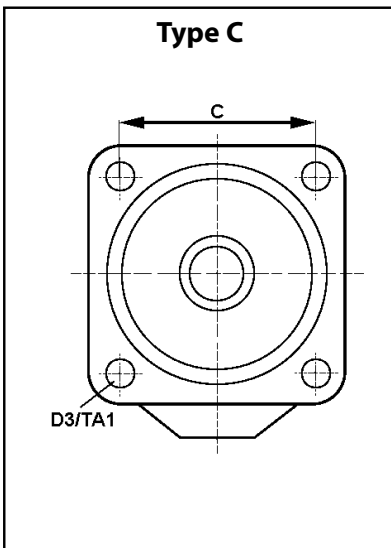

Type D

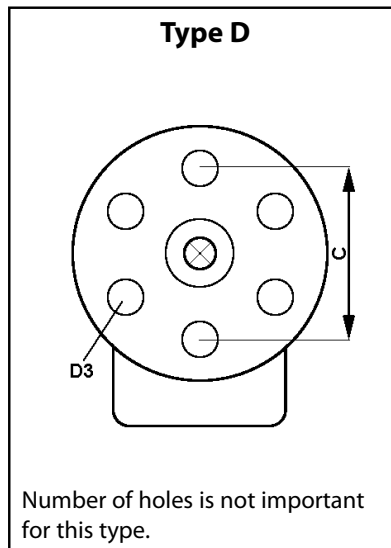

Type E

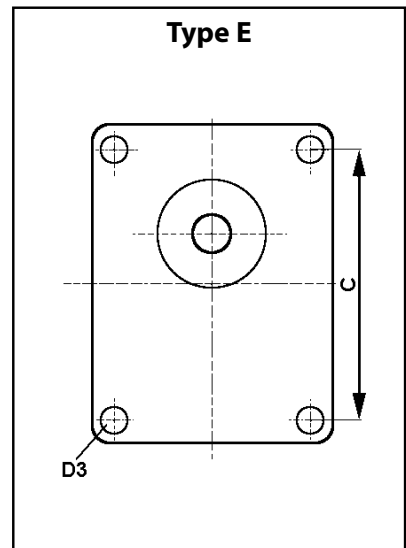

Type F

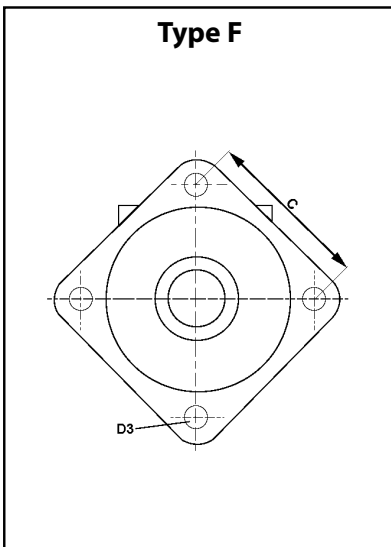

Type S

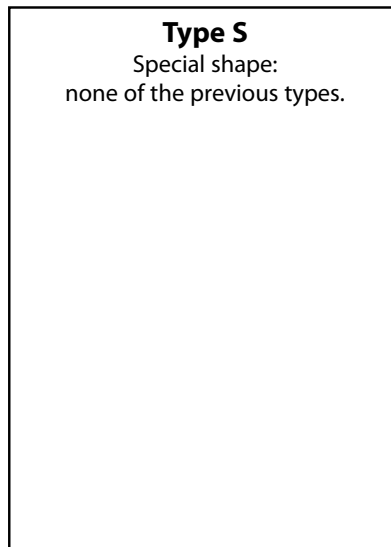

Type Z

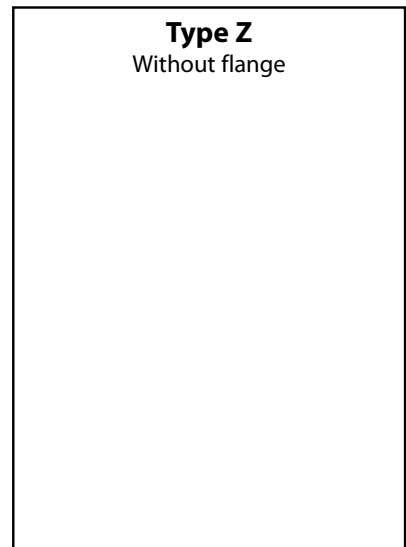



TECHNICAL DETAIL: HYDRAULIC MOTOR

TYPE OF SHAFT

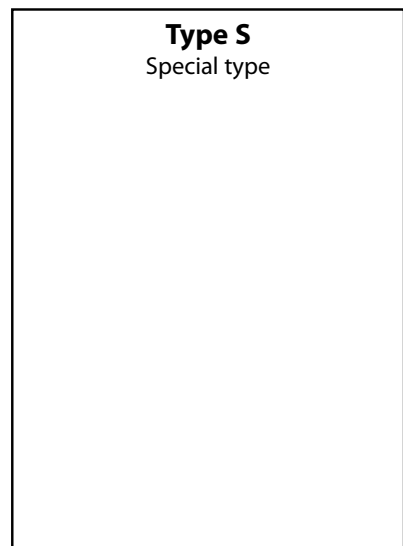
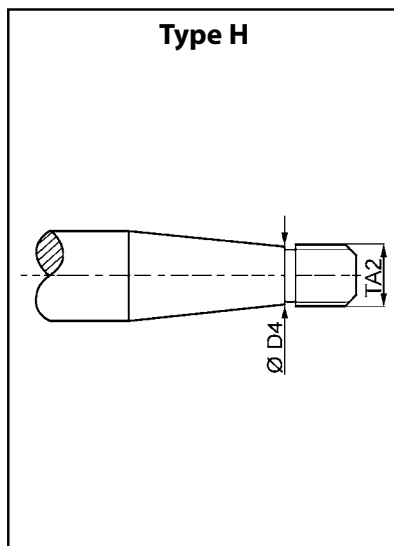
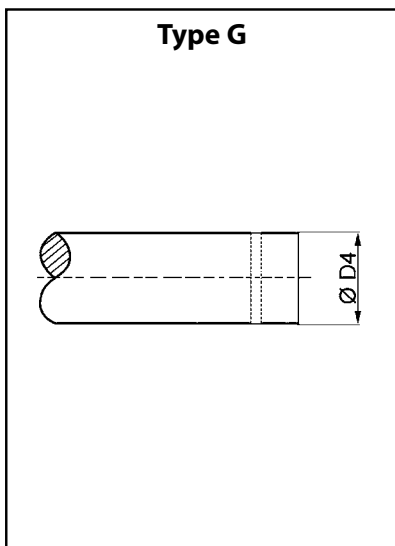
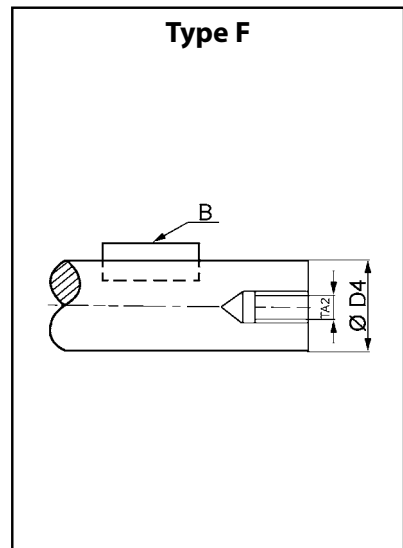
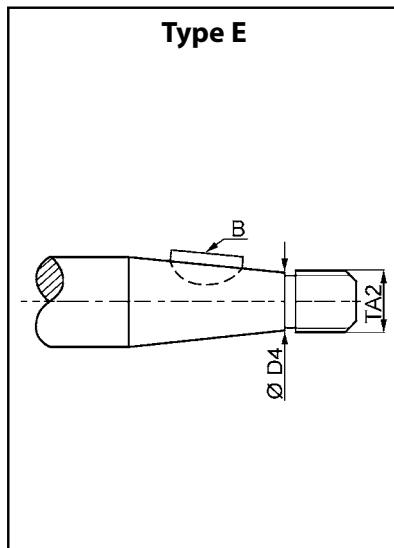
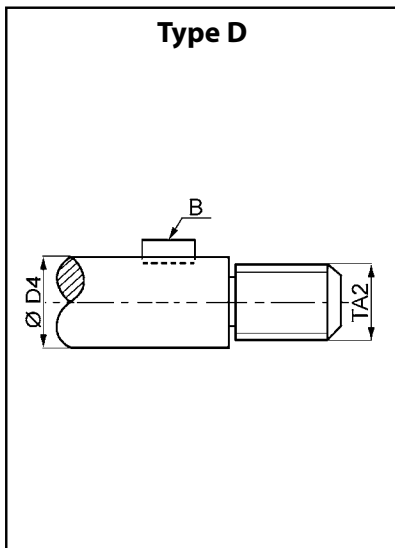
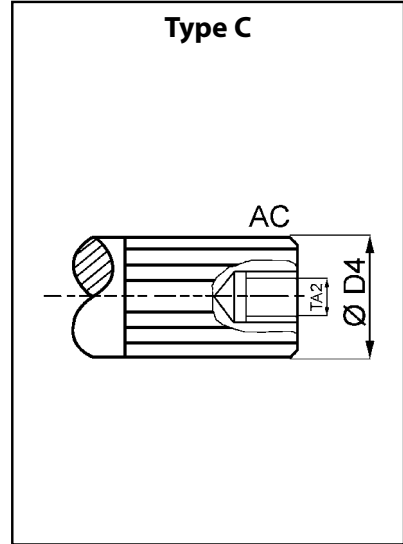
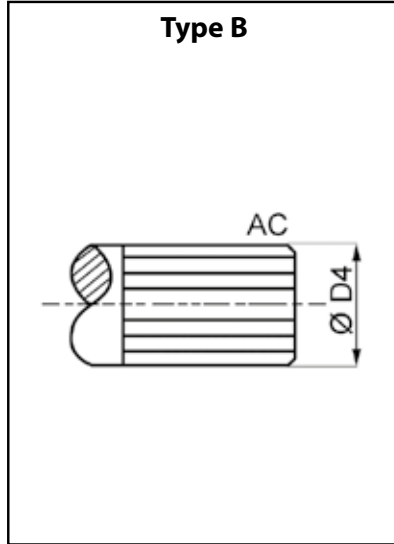
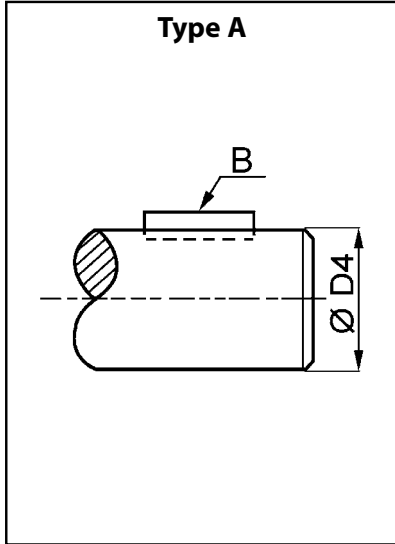



TECHNICAL DETAIL: HYDRAULIC MOTOR

Groep
03-11-00-00



Gegevens klant

Type machine:

Prijsaanvraag

Serienr. machine:

Bestelling

CODE: POS-AS x L1 x L2 x D1 x TY-FL x D2 x AT-GA x D3 x TA1 x Pm1 x Pi1 x C x TY-AS x L3 x D4 x AC x B x TA2 x Pm2 x Pi2 x AT-AS x TA3 x Pm3 x Pi3 x TA4 x Pm4 x Pi4 x D5 x TA5 x Pm5 x Pi5 x MERK

- POS-AS..... Positie aansluitingen.
- L1..... Lengte van de hydromotor, zie figuur.
- L2..... Lengte, zie figuur.
- D1 Diameter, zie figuur.
- TY-FL..... Type flens, zie figuren.
- D2 Halsdiameter, zie figuur.
- AT-GA..... Aantal bevestigingsgaten in de flens.
- D3 Diameter bevestigingsgaten, zie figuur.
- TA1 Draadsoort, zie figuren.
- Pm1..... Pas metrisch.
- Pi1 Pas per duim.
- C..... Centerafstand tussen verste bevestigingsgaten, zie figuur.
- TY-AS Type as, zie figuren.
- L3..... Afstand, zie figuur.
- D4 Asdiameter, zie figuur.
- AC Aantal kanaluren.
- B..... Breedte spie of spiegleuf, zie figuren.
- TA2 Draadsoort, zie figuren.

zie Engelse technische fiche !



TECHNICAL DETAIL: HYDRAULIC MOTOR

- Pm2..... Pas metrisch.
- Pi2 Pas per duim.
- AT-AS Aantal aansluitingen.
- TA3 Draadsoort aansluitingen. Indien verschillende draadsoorten, TA3 is de grootste.
- Pm3..... Pas metrisch.
- Pi3 Pas per duim.
- TA4 Tweede draadsoort aansluitingen, indien aanwezig.
- Pm4..... Pas metrisch.
- Pi4 Pas per duim.
- D5 Diameter aansluiting, indien aanwezig.
- TA5 Montage draadsoort.
- Pm5..... Pas metrisch.
- Pi5 Pas per duim.
- MERK Merk van de hydromotor.

zie Engelse technische fiche !



TECHNICAL DETAIL: HYDRAULIC MOTOR

Groupe
03-11-00-00



Données client

Type machine :

Demande de prix

No. série machine :

Commande

CODE : POS-AS x L1 x L2 x D1 x TY-FL x D2 x AT-GA x D3 x TA1 x Pm1 x Pi1 x C x TY-AS x L3 x D4 x AC x B x TA2 x Pm2 x Pi2 x AT-AS x TA3 x Pm3 x Pi3 x TA4 x Pm4 x Pi4 x D5 x TA5 x Pm5 x Pi5 x MERK

- POS-AS..... Position des connexions.
- L1..... Longueur du moteur hydraulique, voir figure.
- L2..... Longueur, voir figure.
- D1 Diamètre, voir figure.
- TY-FL..... Type de bourrelet, voir figures.
- D2 Diamètre du col, voir figures.
- AT-GA..... Nombre de trous de fixation sur la flasque.
- D3 Diamètre des trous de fixation.
- TA1 Type de filetage, voir figures.
- Pm1..... Pas métrique.
- Pi1 Pas en pouce.
- C..... Entraxe des trous de fixation, voir figures.
- TY-AS Type d'axe, voir figures.
- L3..... Distance, voir figure.
- D4 Diamètre de l'axe.
- AC Nombre de cannelures.
- B..... Largeur clavette ou rainure de clavetage.
- TA2 Type de filetage, voir figures.

voir la fiche technique en Anglais.



TECHNICAL DETAIL: HYDRAULIC MOTOR



Pm2..... Pas métrique.

Pi2..... Pas en pouce.

AT-AS..... Nombre de connexions.

TA3..... Type de filetage des connexions. S'il y a plusieurs filetages, TA3 est le plus grand.

Pm3..... Pas métrique.

Pi3..... Pas en pouce.

TA4..... Deuxième type de filetage des connexions, si présent.

Pm4..... Pas métrique.

Pi4..... Pas en pouce.

D5..... Diamètre de connexion, si présent.

TA5..... Type de filetage pour montage.

Pm5..... Pas métrique.

Pi5..... Pas en pouce.

MERK..... Marque du moteur hydraulique.

voir la fiche technique en Anglais.



TECHNICAL DETAIL: HYDRAULIC MOTOR

Gruppe
03-11-00-00



Kundendaten

Maschinentyp:

Preis Anfrage

Serien-Nr. Maschine:

Bestellung

CODE: POS-AS x L1 x L2 x D1 x TY-FL x D2 x AT-GA x D3 x TA1 x Pm1 x Pi1 x C x TY-AS x L3 x D4 x AC x B x TA2 x Pm2 x Pi2 x AT-AS x TA3 x Pm3 x Pi3 x TA4 x Pm4 x Pi4 x D5 x TA5 x Pm5 x Pi5 x MERK

- POS-AS..... Typ Hydraulikmotor, siehe Abbildungen.
- L1..... Länge des Hydraulikmotors, siehe Abbildung.
- L2..... Länge, siehe Abbildung.
- D1 Durchmesser, siehe Abbildung.
- TY-FL..... Flanschttyp, siehe Abbildung.
- D2 Halsdurchmesser, siehe Abbildung.
- AT-GA..... Anzahl Befestigungslöcher im Flansch.
- D3 Durchmesser Befestigungslöcher, siehe Abbildungen.
- TA1 Gewindeart, siehe Abbildungen.
- Pm1..... Maß, metrisch.
- Pi1 Maß, in Zoll.
- C..... Mittenabstand zwischen den am weitesten auseinanderliegenden Befestigungslöchern, siehe Abbildung.
- TY-AS Achsentyp, siehe Abbildungen.
- L3..... Abstand Kanneluren, siehe Abbildung.
- D4 Achsendurchmesser, siehe Abbildung.
- AC Anzahl Kanneluren.
- B..... Breite Achsnagel oder Rille, siehe Abbildungen.

Siehe technische Datenblätter auf Englisch.



TECHNICAL DETAIL: HYDRAULIC MOTOR



- TA2 Gewindeart, siehe Abbildungen.
- Pm2..... Maß, metrisch.
- Pi2 Maß, in Zoll.
- AT-AS Anzahl Anschlüsse.
- TA3 Gewindeart Anschlüsse. Falls verschiedene Anschlüsse vorhanden, ist TA3 der grösste.
- Pm3..... Maß, metrisch.
- Pi3 Maß, in Zoll.
- TA4 Zweite Gewindeart Anschlüsse, falls vorhanden.
- Pm4..... Maß, metrisch.
- Pi4 Maß, in Zoll.
- D5 Durchmesser Anschlüsse, falls vorhanden.
- TA5 Montage Gewindeart.
- Pm5..... Maß, metrisch.
- Pi5 Maß, in Zoll.
- MERK Marke des Hydraulikmotors.

Siehe technische Datenblätter auf Englisch.



4

HYDRAULIC DISTRIBUTORS



COMPLETE DISTRIBUTOR BLOCK



These units have to be ordered by giving full details of the distributor block make or the complete machine details. We can offer you the brands below:

Bucher, Bucholz, Eaton (Vickers), Hawe, Husco, Kyb, Linde-Hydraulics, Parker, Rexroth, Salami, Shimadzu

SEPARATE PARTS FOR DISTRIBUTOR BLOCKS



REF 131TA7005
Separate handle small version
with mounting holes \varnothing 5,1 mm
at center distances 25 mm
in both directions



REF 131TA7006
Separate handle big version
with mounting holes \varnothing 5,3 mm
at center distances 30 and 28 mm



REF 116TA4766
Kit lever



HYDRAULIC DISTRIBUTORS

We have developed a test bench which allows us to test almost every hydraulic valve in a way that is very close to the normal working situation.

The test bench allows us to measure the working pressure and the internal leakage at any time.





5

AUXILIARY VALVES & HANDLE KITS



used for: **HYSTER**



- H2.00-3.20XM; different valve kits possible, depending on serial nrs

REF 131TA4993 - 3rd valve section

used for: **KOMATSU**



- FG/20, 25, 30-12
- FG/FD14, 15, 18-16
- FD10L-14L-15L-18L-16
- FG/FD14, 15, 18-17
- FG15H, FG18H-17

REF 131TA4928 - 3rd valve section



REF 106TA7422 - 3rd valve kit

used for: **KOMATSU**



- FG10D-14-15D-18D-15
- FG/FD15HD-18HD-15
- FD10D-14D-15D-18D-15
- FG/FD20D-25D-30D-11
- FG20S-25S-30S-11

REF 105TA4837 - 3rd valve section



REF 106TA7421 - 3rd valve kit

used for: **LINDE**



- H20-30 / 351
- H35-45 /352

REF 131TA4990 - 3rd valve section



REF 106TA7464 - 3rd valve kit
REF 131TA5011 - 4th valve kit



used for: **LINDE**



REF [131TA4990](#) - 3rd valve section



REF [131TA4991](#) - 3rd valve kit
REF [131TA5012](#) - 4th valve kit

· H12-18 / 350

used for: **LINDE**



REF [131TA4990](#) - 3rd valve section



REF [131TA4992](#) - 3rd valve kit
REF [131TA5013](#) - 4th valve kit

· H50-80 / 353

used for: **mitsubishi**

- FG28, 30, 35A - F13D
- FG20, 25K - EF17B
- FG20, 23, 25-F17B
- FG10, 14, 15, 18 - F25B
- FG10, 14, 15, 18 - F25A
- FD28, 30, 35A-F14C
- FD20, 25K - EF18B
- FD20, 23, 25-F18B
- FD10, 15, 25 - EF16



REF [131TA4970](#) - 3rd valve section



REF [106TA7423](#) - 3rd valve kit

used for: **mitsubishi**

- FD28, 30 - F14B
- FD14, 15, 18 - F16A



REF [131TA4858](#) - 3rd valve section



REF [131TA4877](#) - 3rd valve kit
REF [131TA4886](#) - 4th valve kit



used for: **mitsubishi**



- FG28, 30, 35A - F13C
- FD28, 30 - F14B

REF [131TA4970](#) - 3rd valve section



REF [131TA4877](#) - 3rd valve kit
REF [131TA4887](#) - 4th valve kit

used for: **mitsubishi**



- FB18KT, 20KT-EFB5B
- FB18KT, 20KT-EFB5A
- FB16KT-EFB4B
- FB16KT-EFB4A

REF [131TA4872](#) - 3rd valve section



REF [131TA4885](#) - 3rd valve kit
REF [131TA4893](#) - 4th valve kit

used for: **mitsubishi**



- FD60, 70-F20B

REF [131TA4871](#) - 3rd valve section



REF [131TA4881](#) - 3rd valve kit
REF [131TA4890](#) - 4th valve kit

used for: **mitsubishi**



- FD40K, 40KL, 45K - EF19C

REF [131TA4871](#) - 3rd valve section



REF [131TA4883](#) - 3rd valve kit
REF [131TA4892](#) - 4th valve kit



used for: **MITSUBISHI**



REF [131TA4871](#) - 3rd valve section



REF [131TA4881](#) - 3rd valve kit
REF [131TA4890](#) - 4th valve kit

- FD35, 38, 40 - F19A

used for: **NICHIYU-NYK**



REF [131TA4994](#) - 3rd valve section



REF [131TA4997](#) - 3rd valve kit
REF [131TA4997](#) - 4th valve kit

- FB20, 25, 28 P55
- FBT10, 13, 15, 18 P50&60

used for: **NICHIYU-NYK**



REF [131TA4994](#) - 3rd valve section



REF [131TA4998](#) - 3rd valve kit

- FB10, 14, 15, 18 P60
- FB20, 25, 28, 30 P60
- FB10, 14, 15, 18 P65
- FB20, 25, 28, 30 P65

used for: **NICHIYU-NYK**



REF [131TA4994](#) - 3rd valve section



REF [131TA4999](#) - 3rd valve kit
REF [131TA5001](#) - 4th valve kit

- FB10, 14, 15, 18, 20, 25, 30P70&75; includes microswitch



used for: **NICHIYU-NYK**



REF [131TA4996](#) - 3rd valve section



REF [131TA5000](#) - 3rd valve kit
REF [131TA5003](#) - 4th valve kit

- FBT10, 13, 15, 18 P70

used for: **NICHIYU-NYK**



REF [131TA4994](#) - 3rd valve section



REF [106TA7427](#) - 3rd valve kit
REF [131TA5002](#) - 4th valve kit

- FB10, 14, 15, 18 P-50
- FB10, 14, 15, 18 P-55

used for: **NICHIYU-NYK**



REF [131TA4995](#) - 3rd valve section



REF [131TA5000](#) - 3rd valve kit
REF [131TA5003](#) - 4th valve kit

- FBT10, 13, 15, 18 P65

used for: **NISSAN**



REF [106TA7426](#) - 3rd valve section



REF [106TA7425](#) - 3rd valve kit
REF [131TA4936](#) - 4th valve kit

- J01
- J02



used for: **NISSAN**



REF [106TA7995](#) - 3rd valve section



REF [106TA7425](#) - 3rd valve kit
REF [131TA4936](#) - 4th valve kit

· J01

used for: **NISSAN**



REF [106TA7995](#) - 3rd valve section



REF [106TA7424](#) - 3rd valve kit
REF [131TA4937](#) - 4th valve kit

· J01
· J02

used for: **NISSAN**



REF [131TA4929](#) - 3rd valve section



REF [106TA7425](#) - 3rd valve kit
REF [131TA4936](#) - 4th valve kit

· J02

used for: **NISSAN**



REF [131TA4875](#) - 3rd valve section



REF [131TA4932](#) - 3rd valve kit
REF [131TA4938](#) - 4th valve kit

· PL/FL/UGL02



used for: **NISSAN**



REF [131TA4930](#) - 3rd valve section



REF [131TA4933](#) - 3rd valve kit
REF [131TA4939](#) - 4th valve kit

· F04

used for: **NISSAN**



REF [131TA4931](#) - 3rd valve section



REF [131TA4934](#) - 3rd valve kit

· 1B1/1B2

used for: **NISSAN**



REF [131TA4875](#) - 3rd valve section



REF [131TA4932](#) - 3rd valve kit
REF [131TA4938](#) - 4th valve kit

· 1F1/1F2

used for: **NISSAN**



REF [131TA4929](#) - 3rd valve section



REF [131TA4935](#) - 3rd valve kit

· D02



used for: **STILL**



REF [131TA4896](#) - 3rd valve section



REF [131TA4899](#) - 3rd valve kit
REF [131TA4902](#) - 4th valve kit

· R50; serie 5041 - 5044

used for: **STILL**



REF [131TA4897](#) - 3rd valve section



REF [131TA4900](#) - 3rd valve kit
REF [131TA4903](#) - 4th valve kit

· R60; serie 6022 - 6025

used for: **STILL**



REF [131TA4898](#) - 3rd valve section



REF [131TA4901](#) - 3rd valve kit
REF [131TA4904](#) - 4th valve kit

· R70; serie 7048 - 7050

used for: **TCM**



REF [131TA4975](#) - 3rd valve section



REF [131TA4982](#) - 3rd valve kit

· FD35, 50, 60Z4
· FD35, 50Z5
· FD35, 38, 50Z6
· FD40, 70Z2
· F(V)D50, 60, 70Z7



used for: **TCM**



REF [131TA4976](#) - 3rd valve section



REF [131TA4982](#) - 3rd valve kit

- F(V)G15 - F(V)D15

used for: **TCM**



REF [105TA4837](#) - 3rd valve section



REF [106TA7458](#) - 3rd valve kit

REF [131TA5004](#) - 4th valve kit

- FHG36N8
- FG20, 25N2S
- FD20, 25Z2S
- FVD10, 18Z15
- FHG30, 36N8
- FVD23, 25Z1
- FVD28, 30Z7
- FVG28, 30N7

used for: **TCM**



REF [105TA4837](#) - 3rd valve section



REF [131TA4983](#) - 3rd valve kit

REF [131TA5005](#) - 4th valve kit

- FD20, 23, 25Z3; Alpha series
- FG20, 23, 25N3; Alpha series
- FHD20, 30Z
- FHG20, 30N
- FD28, 30Z8
- FD20, 25 Z14; Alpha series

used for: **TCM**



REF [131TA4977](#) - 3rd valve section



REF [131TA4984](#) - 3rd valve kit

REF [131TA5006](#) - 4th valve kit

- FG/FD20, 25, 30T6
- FG/FD20, 25, 30C6
- FD23, 28, 30Z5
- FG10, 15, 18C19



used for: **TCM**



REF [131TA4978](#) - 3rd valve section



REF [131TA4984](#) - 3rd valve kit
REF [131TA5006](#) - 4th valve kit

- FB10, 25-6
- FHB15-6

used for: **TCM**



REF [105TA4837](#) - 3rd valve section



REF [131TA4985](#) - 3rd valve kit
REF [131TA5007](#) - 4th valve kit

- FB10, 14, 15H5&H15
- FHG35, 36N9&Z9
- FD20, 25Z4
- FB20, 25H5&H15

used for: **TCM**



REF [131TA4873](#) - 3rd valve section



REF [131TA4987](#) - 3rd valve kit
REF [131TA5008](#) - 4th valve kit

- FG20, 30C13
- FG/FD20, 30W3
- FD20, 30T3

used for: **TCM**



REF [131TA4980](#) - 3rd valve section



REF [131TA4987](#) - 3rd valve kit
REF [131TA5008](#) - 4th valve kit

- F(H)G/F(H)D20, 25T3(13); Inoma series
- F(H)G/F(H)D20, 25C3(13); Inoma series
- F(H)G/F(H)D20, 25W3(13); Inoma series



used for: **TCM**



REF [131TA4979](#) - 3rd valve section



REF [131TA4988](#) - 3rd valve kit
REF [131TA5009](#) - 4th valve kit

- FTB16, 18-7

used for: **TCM**



REF [131TA4981](#) - 3rd valve section



REF [131TA4989](#) - 3rd valve kit
REF [131TA5010](#) - 4th valve kit

- FD35, 45C9
- FG/FD35, 40, 45, 50T2
- FG/FD35, 40, 45, 50T9

used for: **TOYOTA**



REF [131TA4957](#) - 3rd valve section



REF [131TA4960](#) - 3rd valve kit
REF [131TA4966](#) - 4th valve kit

- 7FB10, 15, 20, 25, 30

used for: **TOYOTA**



REF [131TA4958](#) - 3rd valve section



REF [131TA4961](#) - 3rd valve kit
REF [131TA4967](#) - 4th valve kit

- 7FG10, 15, 20, 25, 30; from 08-'05 (valve with 2 mounting holes)
- 7FD10, 15, 20, 25, 30; from 08-'05 (valve with 2 mounting holes)
- 7FGF15, 18, 20, 25, 25, 30; from 08-'05 (valve with 2 mounting holes)
- 7FDF15, 18, 20, 25, 35; from 08-'05 (valve with 2 mounting holes)



used for: **TOYOTA**

- 7FG10, 15, 18, 20, 25, 30; thermic truck - 4 bolt valve block
- 7FD10, 15, 20, 25, 30; thermic truck - 4 bolt valve block
- 7FGF15, 18, 20, 25, 30; thermic truck - 4 bolt valve block
- 7FDF15, 18, 20, 25, 35; thermic truck - 4 bolt valve block



REF [152TA2058](#) - 3rd valve section



REF [131TA4962](#) - 3rd valve kit
REF [131TA4968](#) - 4th valve kit

used for: **TOYOTA**

- 7FG10, 15, 18, 20, 25, 30; thermic truck - 4 bolt valve block
- 7FD10, 15, 20, 25, 30; thermic truck - 4 bolt valve block
- 7FGF15, 18, 20, 25, 30; thermic truck - 4 bolt valve block
- 7FDF15, 18, 20, 25, 35; thermic truck - 4 bolt valve block



REF [152TA2058](#) - 3rd valve section



REF [131TA4960](#) - 3rd valve kit
REF [131TA4968](#) - 4th valve kit

used for: **TOYOTA**

- 7FG10, 15, 18, 20, 25, 30; 2 bolt valve block
- 7FD10, 15, 20, 25, 30; 2 bolt valve block
- 7FGF15, 18, 20, 25, 30; 2 bolt valve block
- 7FDF15, 18, 20, 25, 35; 2 bolt valve block



REF [152TA2058](#) - 3rd valve section



REF [131TA4961](#) - 3rd valve kit
REF [131TA4968](#) - 4th valve kit

used for: **TOYOTA**

- 7FG35, 40; 7 serie 3, 5 and 4 ton
- 7FD35, 40; 7 serie 3, 5 and 4 ton
- 7FGF35, 40; 7 serie 3, 5 and 4 ton
- 7FDF35, 40; 7 serie 3, 5 and 4 ton



REF [152TA2058](#) - 3rd valve section



REF [131TA4963](#) - 3rd valve kit
REF [131TA4968](#) - 4th valve kit



used for: **TOYOTA**



REF [131TA4958](#) - 3rd valve section



REF [131TA4964](#) - 3rd valve kit
REF [131TA4969](#) - 4th valve kit

· 8F

used for: **TOYOTA**



REF [131TA4959](#) - 3rd valve section



REF [131TA4965](#) - 3rd valve kit
REF [131TA4966](#) - 4th valve kit

· 8F; joystick controlled

used for: **TOYOTA**



REF [106TA7408](#) - 3rd valve section



REF [106TA7407](#) - 3rd valve kit

· 4FG10, 14, 15, 18
· 3FD10, 14, 15, 18
· 3FG20, 25, 33, 35, 40
· 2FD20, 25, 30

used for: **TOYOTA**



REF [106TA7991](#) - 3rd valve section



REF [106TA7409](#) - 3rd valve kit

· 5FGF/5FDF - 10, 15, 20, 25 (8710 - 8912)



used for: **TOYOTA**



REF [106TA7417](#) - 3rd valve section



REF [115TA6976](#) - 3rd valve kit

· FBM - 16, 20, 25

used for: **TOYOTA**



REF [115TA6977](#) - 3rd valve section



REF [106TA7409](#) - 3rd valve kit

· 5FG/5FD 35, 40, 45; up to april 93

used for: **TOYOTA**



REF [115TA6978](#) - 3rd valve section



REF [115TA6979](#) - 3rd valve kit

· 5FG/5FD 35, 40, 45; from april 93

used for: **TOYOTA**



REF [106TA7991](#) - 3rd valve section



REF [105TA4838](#) - 3rd valve kit

· Series 5 (8909 -)
· 5FGF/5FDF-10, 15, 20, 25 (8912 -)



used for: **TOYOTA**



REF [106TA7992](#) - 3rd valve section



REF [106TA7410](#) - 3rd valve kit

- 6FG/6FD10, 14, 15, 18
- 6FG/6FD20, 23, 25
- 6FG/6FD28, 30

used for: **TOYOTA**



REF [106TA7412](#) - 3rd valve section



REF [106TA7411](#) - 3rd valve kit

- 2FBE15
- 2FB10, 13, 15, 18

used for: **TOYOTA**



REF [106TA7414](#) - 3rd valve section



REF [106TA7413](#) - 3rd valve kit

- FBA10, 15
- 4FB10, 14, 15, 20, 25
- FBA20, 25 (8003 - 8711)

used for: **TOYOTA**



REF [105TA4835](#) - 3rd valve section



REF [106TA7415](#) - 3rd valve kit

- 4FB10, 14, 15; from (8711 -)
- 4FB20, 25; from (8711 -)
- FBA10, 15, 20, 25; from (8711 -)



used for: **TOYOTA**



REF [106TA7417](#) - 3rd valve section



REF [106TA7416](#) - 3rd valve kit

- 5FB10, 15, 18
- 5FB20, 25, 30

used for: **TOYOTA**



REF [106TA7993](#) - 3rd valve section



REF [106TA7418](#) - 3rd valve kit

- 5FBE10, 13, 15, 18

used for: **TOYOTA**



REF [106TA7420](#) - 3rd valve section



REF [106TA7419](#) - 3rd valve kit

- 6FB10, 14, 15, 20, 25, 30

used for: **TOYOTA**



REF [152TA2058](#) - 3rd valve section



REF [106TA7479](#) - 3rd valve kit

- 7FG15, 20, 25, 30
- 7FD15, 20, 25, 30
- 7FGF15, 18, 20, 25, 30
- 7FDF15, 18, 20, 25, 35



6

TRANSMISSION VALVES



TRANSMISSION VALVE



REF 163TA8686

- 12 V
- Used for: Clark, G-Power, OMG, Tailift

TRANSMISSION VALVE



REF 131TA6955

- 12 V
- Used for: Caterpillar, Mitsubishi, Nissan

TRANSMISSION VALVE



REF 152TA2061

- 12 V
- Used for: Hyster, Hyundai, Jungheinrich, Yale

TRANSMISSION VALVE



REF 131TA6957

- 12 V
- Used for: Caterpillar, Mitsubish, Nissan

TRANSMISSION VALVE



REF 131TA6958

- 12 V
- Used for: Nissan, TCM

TRANSMISSION VALVE



REF 131TA9585

- 12 V
- Used for: Nissan, TCM



TRANSMISSION VALVE



REF 131TA9588

- 12 V
- Used for: Komatsu, Linde, Still

TRANSMISSION VALVE



REF 131TA9587

- 24 V
- Used for: Komatsu, Linde, Nissan, Still

TRANSMISSION VALVE



REF 131TA9589

- 24 V
- Used for: Komatsu, Still

TRANSMISSION VALVE



REF 138TA9333

- 12 V
- Used for: EP-Forklift, Nissan

TRANSMISSION VALVE



REF 134TA3707

- 12 V
- Used for: Kalmar, Komatsu, Linde, Still

TRANSMISSION VALVE



REF 134TA3705

- 24 V
- Used for: Caterpillar, Doosan



TRANSMISSION VALVE



REF [134TA3706](#)

- 12 V
- Used for: Doosan, Hyster, Kalmar, Mitsubishi



7

SOLENOID VALVE COIL



SOLENOID VALVE COIL



Do you want to order a solenoid valve coil?

- Please contact your sales advisor if you want to order a solenoid valve coil
- Fill in our technical sheet and send it to us
- Please give us full details of the coil make, complete machine or coil details



TECHNICAL DETAIL: SOLENOID VALVE COIL

Group
03-07-02-01

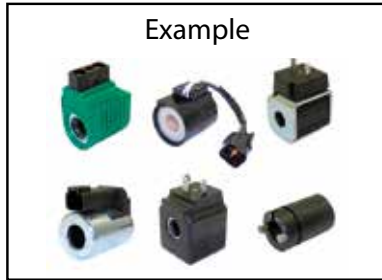

Customer details

Type machine:
Serial n° machine:

Price inquiry
Order

CODE: TY-SPL x TY-CO x U x AC/DC x P x I x R x L x B x D1 x H x D2



- TY-SPL Type of coil:
 - A = square
 - B = round
 - C = half-round
- TY-CO Type of connector:
 - A = 3 pins
 - B = 2 pins
 - C = 1 pin
 - D = 1 wire
 - E = 2 wires
 - F = plug on connector
 - G = plug with wiring
 - H = 2 screws
 - I = 4 pins
 - J = 2 threads
 - K = 1 thread
- U Voltage (Volt).
- AC/DC AC = alternating current, DC = direct current.
- P Power (Watt).
- I Current (Ampere).
- R Resistance (Ohm).
- L Length (without connector), see figures.
- B Width (without connector), see figures.
- D1 Diameter (without connector), see figures.
- H Height (without connector), see figures.
- D2 Core diameter, see figures.



TECHNICAL DETAIL: SOLENOID VALVE COIL

DIMENSIONS

Type A: square

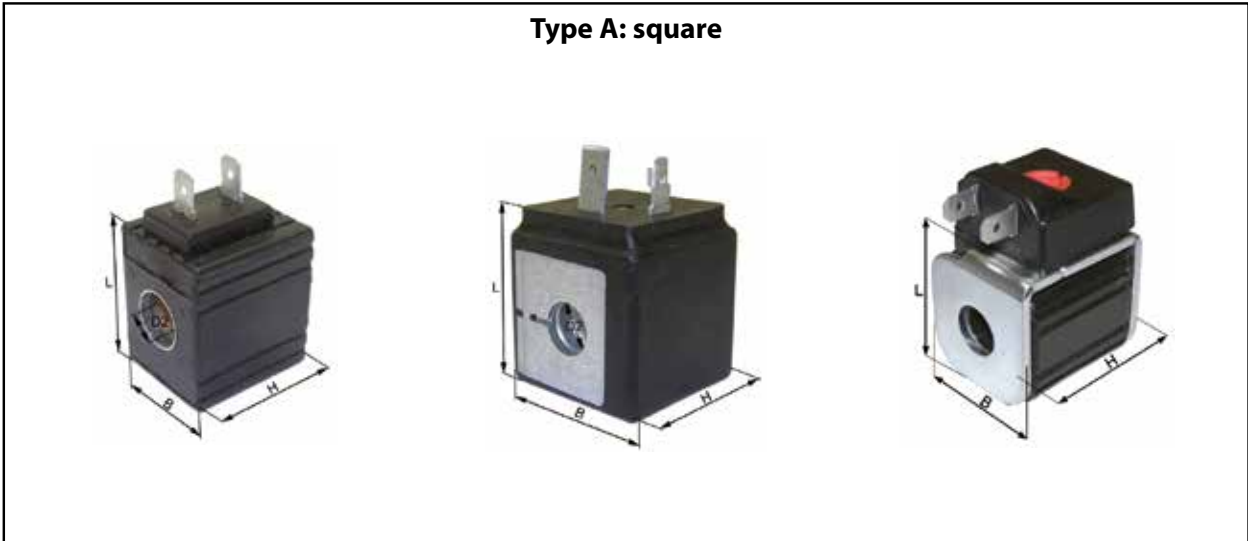

Type B: round

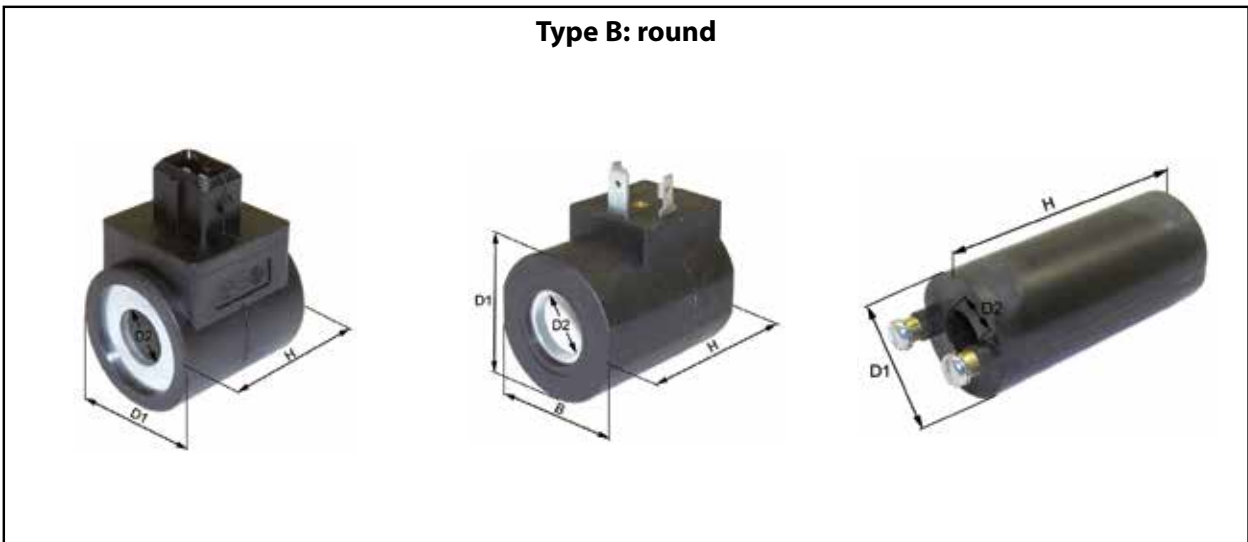

Type C: half-round

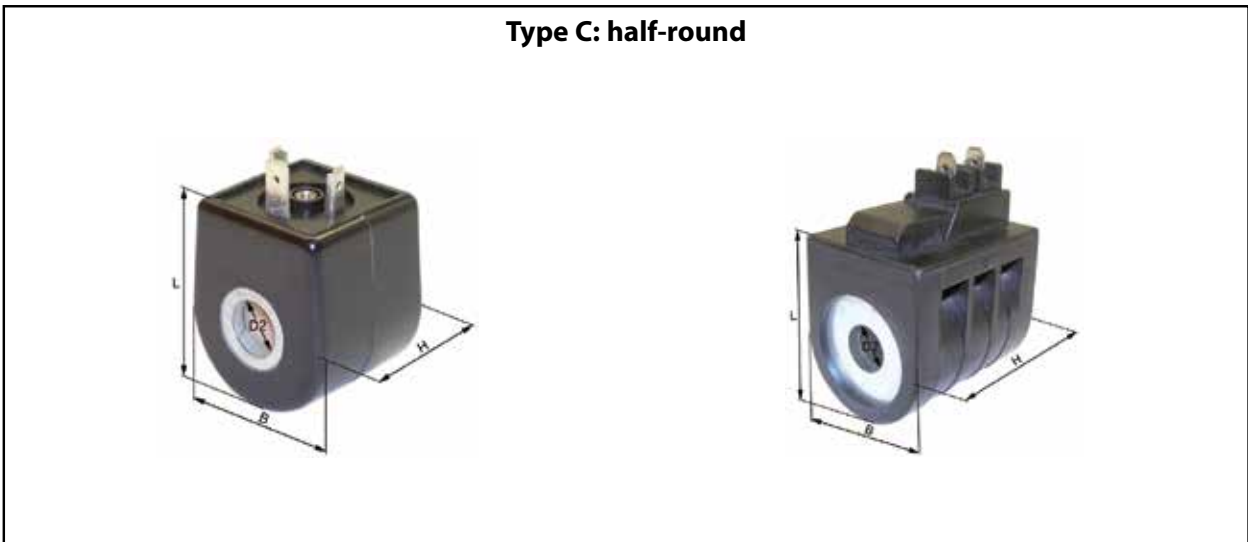



TECHNICAL DETAIL: SOLENOID VALVE COIL

TYPE OF CONNECTOR

Type A: 3 pins



Type B: 2 pins



Type C: 1 pin

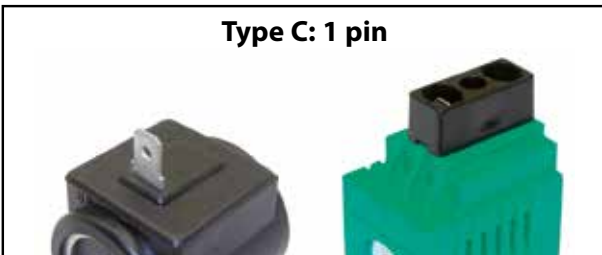

Type D: 1 wire

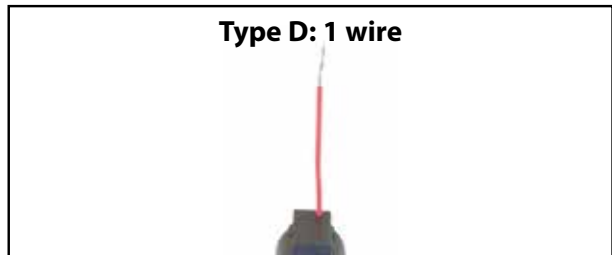

Type E: 2 wires



Type F: plug on connector



Type G: plug with wiring



Type H: 2 screws



Type I: 4 pins



Type J: 2 threads



Type K: 1 thread

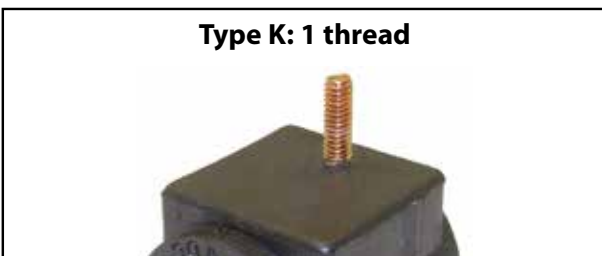



TECHNICAL DETAIL: SOLENOID VALVE COIL

Groep
03-07-02-01



Gegevens klant

Type machine:

Prijsaanvraag

Serienr. machine:

Bestelling

CODE: TY-SPL x TY-CO x U x AC/DC x P x I x R x L x B x D1 x H x D2

- TY-SPL Type spoel:
A = vierkant
B = rond
C = half rond
- TY-CO Type connector:
A = 3 pinnen
B = 2 pinnen
C = 1 pin
D = 1 draad
E = 2 draden
F = fiche op connector
G = fiche met bedrading
H = 2 schroeven
I = 4 pinnen
J = 2 schroefdraden
K = 1 schroefdraad
- U Spanning (Volt).
- AC/DC AC = wisselstroom, DC = gelijkstroom.
- P Vermogen (Watt).
- I Stroom (Ampère).
- R Ohmse weerstand (Ohm).
- L Lengte (zonder connector), zie figuren.
- B Breedte (zonder connector), zie figuren.
- D1 Diameter (zonder connector), zie figuren.
- H Hoogte (zonder connector), zie figuren.
- D2 Diameter kern, zie figuren.

zie Engelse technische fiche !



TECHNICAL DETAIL: SOLENOID VALVE COIL

Groupe
03-07-02-01

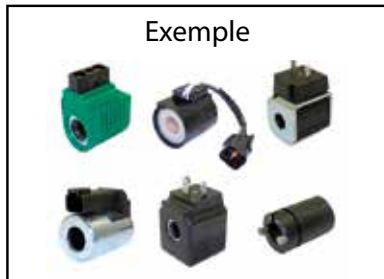

Données client

Type machine :

Demande de prix

No. série machine :

Commande

CODE : TY-SPL x TY-CO x U x AC/DC x P x I x R x L x B x D1 x H x D2



TY-SPL Type solénoïde :

A = carré

B = rond

C = demi rond

TY-CO Type de connecteur :

A = 3 connexions

B = 2 connexions

C = 1 connexion

D = 1 fil

E = 2 fils

F = fiche sur connecteur

G = fiche avec fil

H = 2 vis

I = 4 connexions

J = 2 filetages

K = 1 filetage

U Tension (Volt).

AC/DC AC = courant alternatif, DC = courant continu.

P Puissance (Watt).

I Intensité (Ampère).

R Résistance (Ohm).

L Longueur (sans connecteur), voir figures.

B Largeur (sans connecteur), voir figures.

D1 Diamètre (sans connecteur), voir figures.

H Hauteur (sans connecteur), voir figures.

D2 Diamètre du noyau, voir figures.

voir la fiche technique en Anglais.



TECHNICAL DETAIL: SOLENOID VALVE COIL

Gruppe
03-07-02-01



Kundendaten

Maschinentyp:

Preis Anfrage

Serien-Nr. Maschine:

Bestellung

CODE: TY-SPL x TY-CO x U x AC/DC x P x I x R x L x B x D1 x H x D2

- TY-SPL Typ Spule:
A = Rechteckig
B = Rund
C = Halbrund
- TY-CO Typ Konnektor:
A = 3 Bolzen
B = 2 Bolzen
C = 1 Bolzen
D = 1 Gewinde
E = 2 Gewinde
F = Fitsche auf Konnektor
G = Fitsche mit Verdrahtung
H = 2 Schrauben
I = 4 Bolzen
J = 2 Gewinde
K = 1 Gewinde
- U Spannung (Volt).
- AC/DC AC = Wechselstrom, DC = Gleichstrom.
- P Leistung (Watt).
- I Strom (Ampere).
- R Ohmscher Widerstand (Ohm).
- L Länge (ohne Konnektor), siehe Bild.
- B Breite (ohne Konnektor), siehe Bild.
- D1 Durchmesser (ohne Konnektor), siehe Bild.
- H Höhe (ohne Konnektor), siehe Bild.
- D2 Durchmesser Kern, siehe Bild.

Siehe technische Datenblätter auf Englisch.

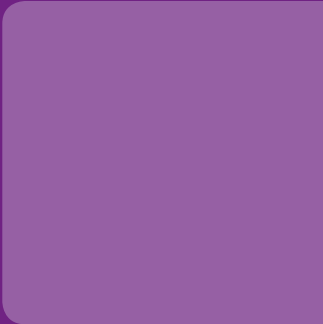
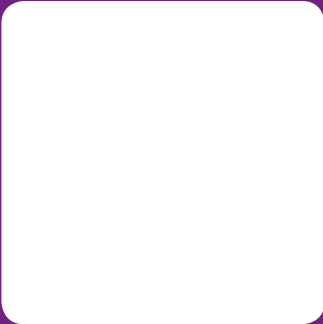

8

CARTRIDGES ELECTROVALVE

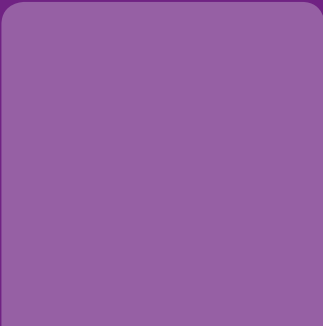



CARTRIDGES ELECTROVALVE			
			
HYDRAFORCE	HYDRAFORCE	HYDRAFORCE	HPI
			
HPI	HYDAC	HYDAC	BUCHER
			
BUCHER	PARKER	PARKER	COMATROL
			
SUN	INTEGRATED HYDRAULICS	STERLING HYDRAULICS	REXROTH

These units have to be ordered by giving full details of the cartridge make, complete machine or valve details.

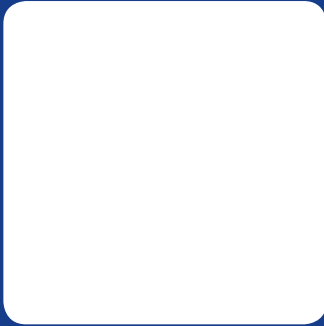

9

HYDRAULIC VALVES AND COMPONENTS



Valves for direct in-line mouting with threaded connections suitable for general use

Due to the variety of operating conditions and applications for these products, it is important that you analyse all aspects of your application before selecting or using one. Through his own analysis and testing, the user is solely responsible for making the final selection of his products and systems. He has to make sure that the environmental requirements of the application are met.

VALVE BLOCK MANIFOLD FOR SIDE SHIFTING CLAMPS

pressure
 return
 slave

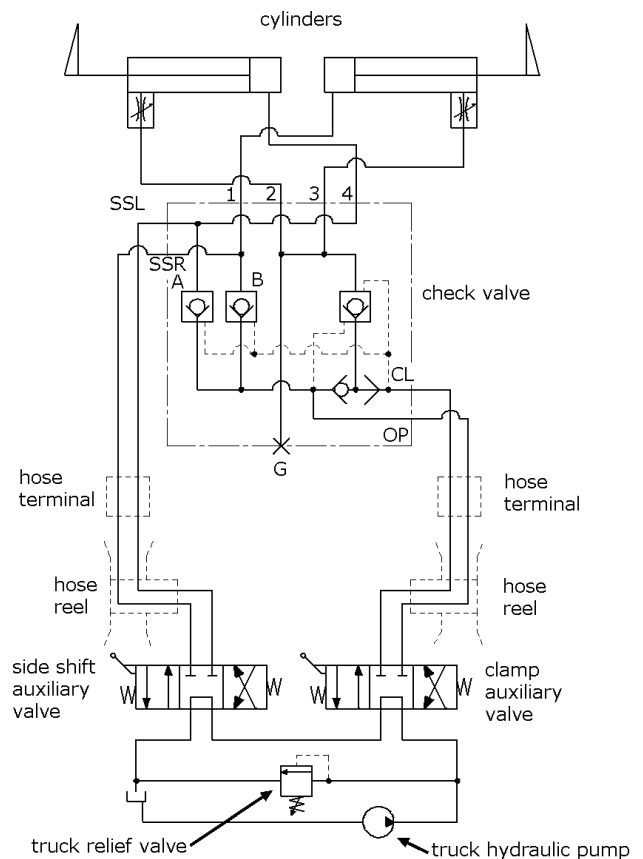
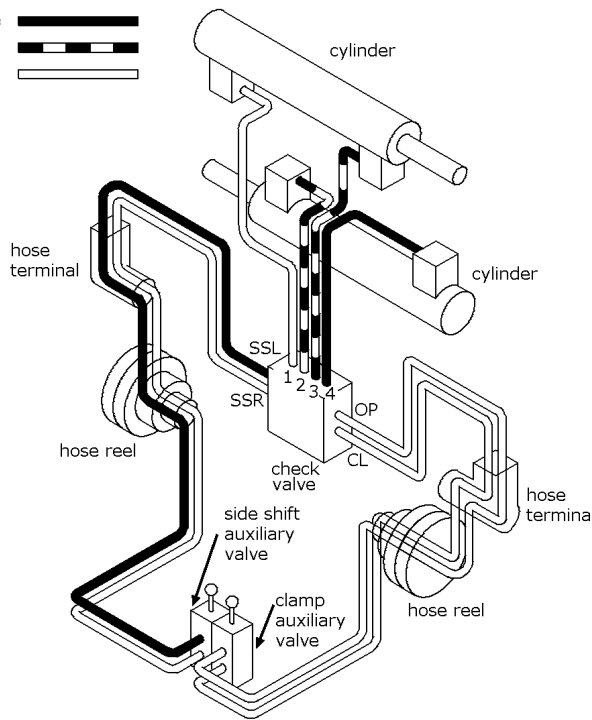

REF 133TA7812

- Connections: CL, OP, 1, 2, 3, 4: 3/4 - 16 UNF
- G, SSL, SSR: 9/16 - 18 UNF
- Pressure: 110 - 160 bar
- Min. flow: 19 l/min
- Regulated flow 38 l/min
- Max. flow: 45 l/min



PRESSURE RELIEF VALVE FOR PAPER CLAMP

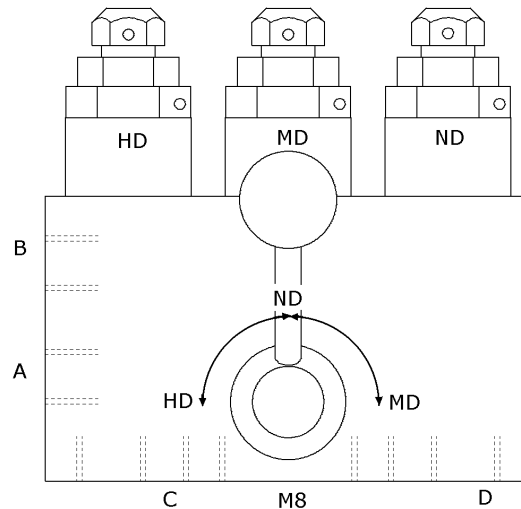
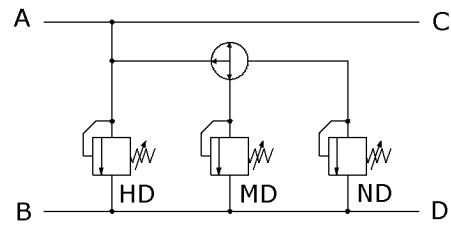

REF 134TA2336

- Mechanical version
- With change-over switch
- 3 pressures
- Up to 200 bar
- Connections: M18 x 1,5

HD = 50-200 bar

MD = 30-180 bar

ND = 0-150 bar

PRESSURE RELIEF VALVE FOR PAPER CLAMP

Pressure relief valve with change-over switch used on paper clamps (3 pressures)

- Adjustable 30 - 180 bar with flow 45 l/min
- With a flow of 10 l/min = max. pressure 150 - 160 bar
- The valve is regulated at 140 bar with flow 30 l/min

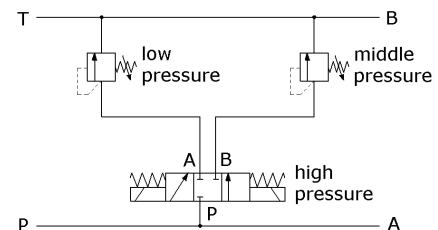

REF 133TA9275

With electro valve 12 V

- Connections: M18 x 1,5
- Pressure: 210 bar
- Flow: 50 l/min

REF 133TA9276

With electro valve 24 V

- Connections: M18 x 1,5
- Pressure: 210 bar
- Flow: 50 l/min

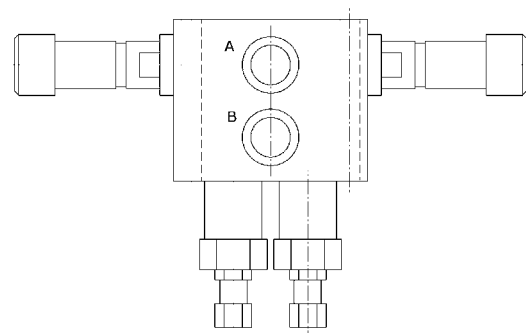



THROTTLE VALVES USED ON FORKLIFT ATTACHMENT

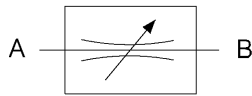
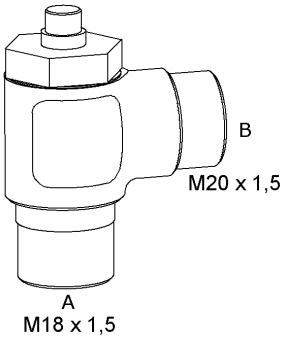

REF 133TA9277

Execution: 1

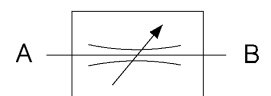
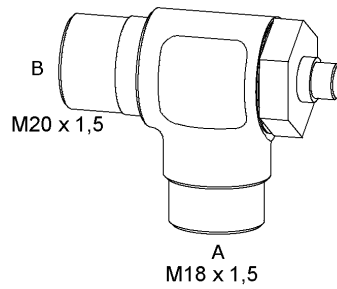

REF 133TA9278

Execution: 2



CHECK VALVES				
REF	Flow	Ports	Symbol	
<u>127TA3836</u>	16 l/min	G1/4		
<u>140TA9077</u>	30 l/min	G3/8		
<u>140TA9078</u>	50 l/min	G1/2		
<u>140TA9079</u>	90 l/min	G3/4		
<u>127TA3841</u>		Port A, B = G3/8 Port Z = G1/4		
<u>127TA3840</u>		Threaded connections = G1/4		
<u>127TA3842</u>		Threaded connections = G3/8		



SINGLE BALL SHUTTLE VALVES

REF 133TA9270

- With signal at port 2
- Max. pressure 250 bar
- Used for load sensing signal
- Connections: M16 x 1,5

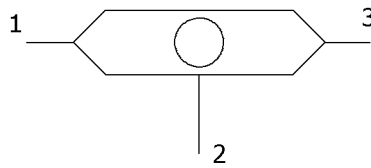

REF 152TA1983

- Connections: 3 x 1/4 BSP





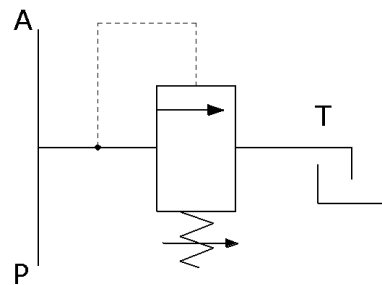

PRESSURE RELIEF VALVES

REF	Flow	Pressure	Ports	
<u>133TA7804</u>	80 l/min	250 bar	P / A / T 3/4 BSP	
<u>133TA7836</u>	30 l/min	350 bar	P / A / T 1/2 BSP	

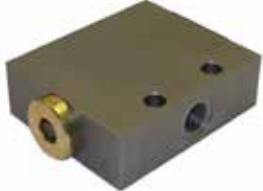
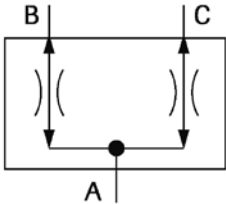
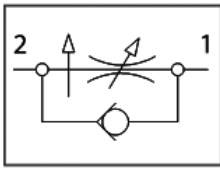

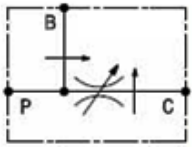

FLOW CONTROL VALVES						
Flow divider – combiner						
REF	Min. flow rate	Max. flow rate	Ports	Max. pressure range	Dividing	
<u>127TA3850</u>	8 l/min	20 l/min	G3/8	350	50:50	 
<u>140TA9080</u>	13 l/min	25 l/min	G3/8	300	50:50	
<u>140TA9081</u>	26 l/min	40 l/min	1 x 1/2" BSP + 2 x 3/8" BSP	300	50:50	
2 ways pressure compensated flow valve						
REF	Max flow	P max	Ports			
<u>131TA9098</u>	18 l/min	250 bar	3/8" BSP			
<u>163TA8517</u>	33 l/min	250 bar	1/2" BSP			
3 ways, pressure compensated flow valve						
REF	Regulated flow	Max flow	P max	Ports		
<u>152TA1986</u>	0-25 l/min	40 l/min	300 bar	3/8" BSP		 
<u>152TA1987</u>	2-50 l/min	90 l/min	300 bar	1 port: 3/4" BSP 2 ports: 1/2" BSP		



THROTTLE VALVES					
Types without bypass					
REF	Flow	Pressure	Ports		
<u>133TA7811</u>	25 l/min	210 bar	1/4 BSP		
<u>152TA1990</u>	30 l/min	400 bar	3/8 BSP		
<u>134TA2335</u>	40 l/min	200 bar	1/2 BSP		
<u>133TA7805</u>	80 l/min	250 bar	3/4 BSP		
<u>133TA7808</u>	200 l/min	320 bar	1 BSP		
Types with bypass					
<u>152TA1991</u>	15 l/min	400 bar	1/4 BSP		
<u>133TA7807</u>	30 l/min	200 bar	3/8 BSP		
<u>133TA7809</u>	40 l/min	200 bar	1/2 BSP		
<u>133TA7806</u>	60 l/min	345 bar	1/2 BSP		
<u>133TA7810</u>	95 l/min	210 bar	3/4 BSP		



DIRECTIONAL VALVES

For all the directional valves below:

- Type NG-6
- 350 Bar
- 70 L/min.



REF [131TA9514](#)
12 VDC



REF [131TA9515](#)
24 VDC

REF [131TA9516](#)
12 VDC



REF [131TA9517](#)
24 VDC

REF [131TA9518](#)
12 VDC



REF [131TA9519](#)
24 VDC

REF [131TA9520](#)
12 VDC



REF [131TA9521](#)
24 VDC

REF [152TA1977](#)
12 VDC



REF [152TA1978](#)
24 VDC



DIRECTIONAL VALVES				
2/2-way				
REF	Voltage	Ports		
127TA3843	12 VDC	Threaded connections = G3/8		
127TA3844	24 VDC			
6/2-way				
REF	Voltage	Ports		
127TA3845	Manual operation	G3/8		
Electrical valve to double the working functions on one lever (universal application)				
REF	Voltage	Ports		
106TA6818 106TA6819 106TA6820 111TA5832 106TA6821	12 V 24 V 48 V 80 V	G3/8 Mounting and lever kit		



DIRECTIONAL VALVES				
3/2-way				
REF	Voltage	Ports		
<u>127TA3846</u>	12 VDC	G3/8		
<u>127TA3847</u>	24 VDC	G3/8		
8/3-way				
REF	Voltage	Ports		
<u>127TA3848</u>	12 VDC	G3/8		
<u>127TA3849</u>	24 VDC	G3/8		



ALUMINIUM PARALLEL MULTIPLE MANIFOLDS – LATERAL PORTS WITH RELIEF VALVE

REF [152TA1979](#)

Aluminium manifold can be used for pressures up to 210 bar (3000PSI)

Ports:

- P-T: BSPP 1/2"
- M: BSPP 1/4" (Measure point)
- A-B: BSPP 3/8"

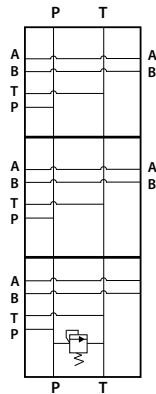

BASE PLATE NG6-CETOP 3



REF [152TA1980](#)

Ports:

- 3/8" BSP

ELECTRICAL CONNECTOR



REF [152TA1981](#)

COVERPLATE NG6

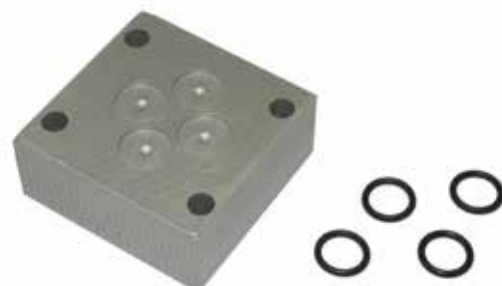

REF [152TA1982](#)



SOLENOID OPERATED CARTRIDGE VALVES



1) Poppet 2-way double lock normally closed

Voltage	Ports	Max flow (l/min)	P max (bar)	REF
12 VDC	G 1/2	70	350	133TA7813
24 VDC	G 1/2	70	350	133TA7814

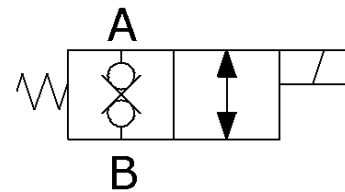

2) Poppet 2-way double lock normally open

Voltage	Ports	Max flow (l/min)	P max (bar)	REF
12 VDC	G 1/2	70	350	133TA7835
24 VDC	G 1/2	70	350	133TA7815

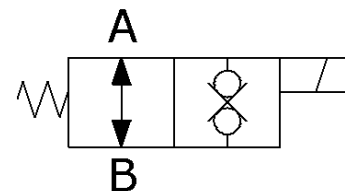

3) Poppet type, normally closed

Voltage	Ports	Max flow (l/min)	P max (bar)	REF
12 VDC	G 3/8	23	207	152TA2007
24 VDC	G 3/8	23	207	152TA2008

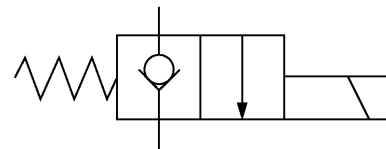

4) Poppet type, normally open

Voltage	Ports	Max flow (l/min)	P max (bar)	REF
12 VDC	G 3/8	23	207	163TA8267
24 VDC	G 3/8	23	207	152TA2010

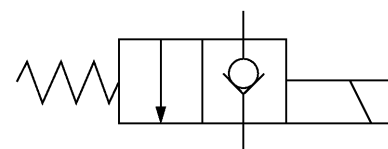



HOSE BURST VALVES

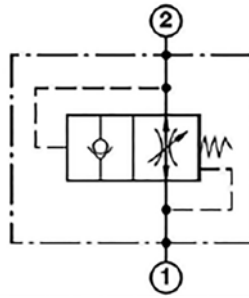
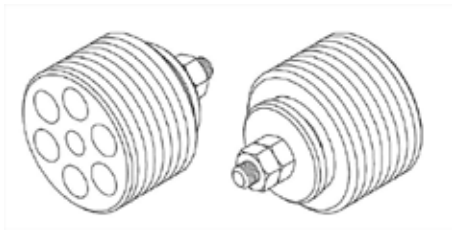

GAS	Max flow (l/min)	Max pressure (bar)	REF
1/4"	25	350	152TA1993
3/8"	50	350	152TA1995
1/2"	80	350	152TA1996
3/4"	150	350	152TA1997

Special tool to mount hose burst valve

GAS	REF
3/8"	152TA2001
1/2"	152TA1999
3/4"	152TA1998





HYDRAULIC DISTRIBUTOR

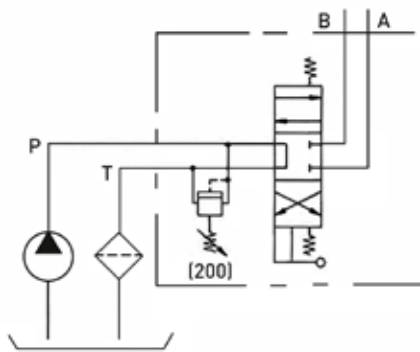

REF 106TA6806

- Ports: G 3/8 BSP
- Max flow: 35 l/min



HYDRAULIC DISTRIBUTOR

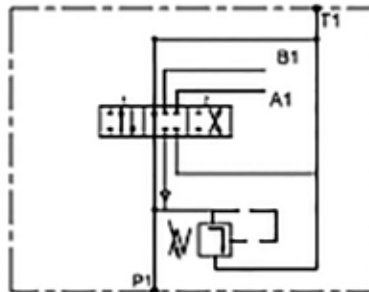

REF 152TA2003

- Ports: G 3/8 BSP
- Max flow: 35 l/min



HYDRAULIC DISTRIBUTOR WITH MICROSWITCH

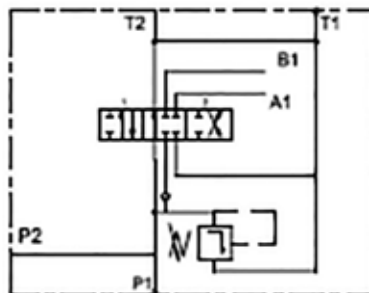

REF 152TA2005

- Ports: 3/8 BSP
- Max flow: 35 l/min



HYDRAULIC DISTRIBUTOR

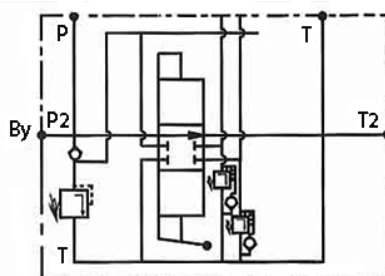

REF 163TA8519

- Connections: P, A, B = G 3/4 BSP
- T = G1
- Inclusive carry over plug G1
- Max flow: 120 l/min
- P max: 250 bar/inclusive carry over plug





RAPID EXT LOG SPLITTER VALVE

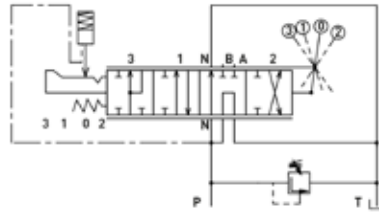
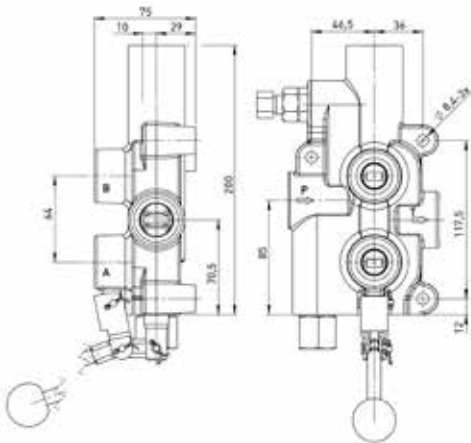

REF 152TA2011

Ports: 1/2 BSP

2 WAYS BALL VALVES

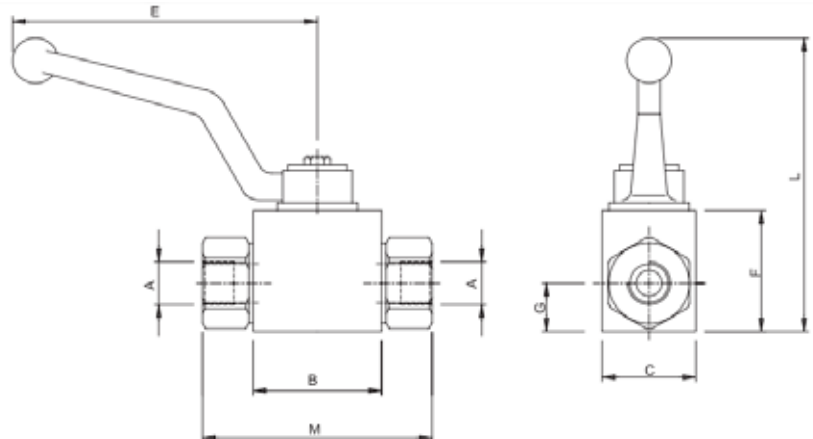
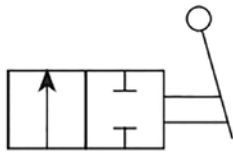

Ports	REF
1" BSP	152TA2039
1/2" BSP	152TA2040
3/8" BSP	152TA2041
1/4" BSP	152TA2042

3 WAYS BALL VALVES

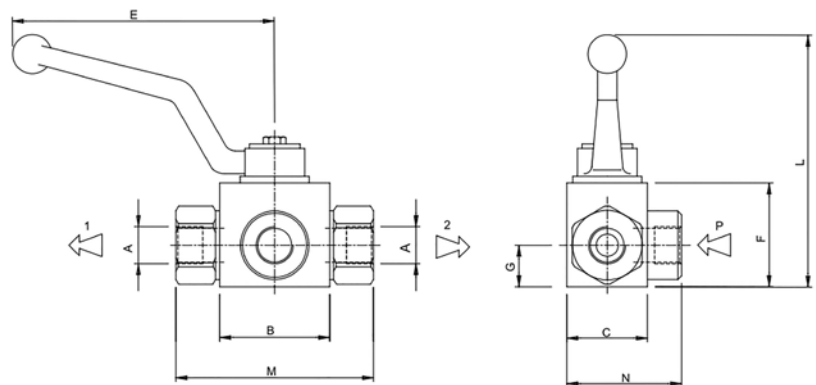
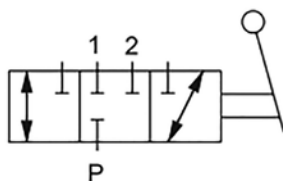

Ports	REF
1" BSP	152TA2749
3/4" BSP	152TA2748
1/2" BSP	152TA2747
3/8" BSP	152TA2746



UNIVERSAL KIT TO ADD AN EXTRA FUNCTION ON YOUR FORKLIFT WITH HYDRAULIC HOSE REEL

- 1. 6/2 valve
- 2. Hose reel
- 3. Switch
- 4. Swivel

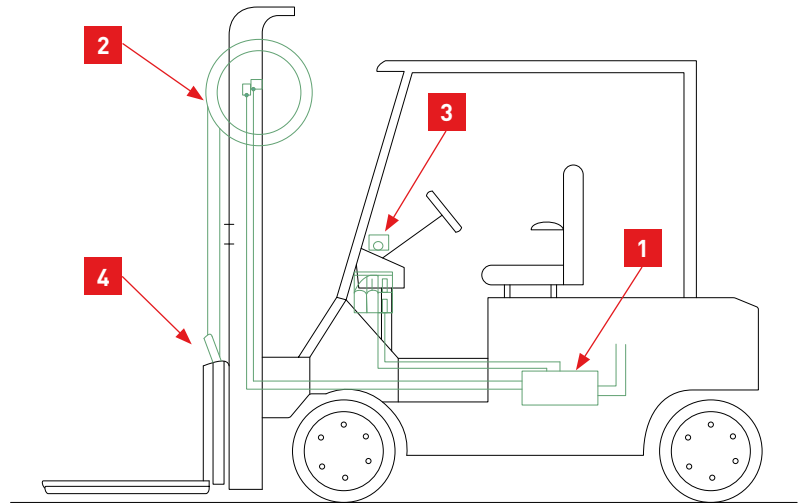

1) 6/2 valve

3/8 BSP

Type	REF
6/2 valve 12 V	106TA6818
6/2 valve 24 V	106TA6819
6/2 valve 48 V	106TA6820
6/2 valve 80 V	111TA5832

1/2 BSP

Type	REF
6/2 valve 12 V	161TA5963
6/2 valve 24 V	161TA5964
6/2 valve 48 V	161TA5965
6/2 valve 80 V	161TA5966

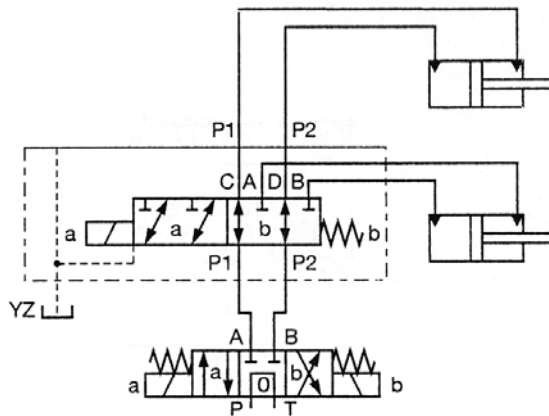



UNIVERSAL KIT TO ADD AN EXTRA FUNCTION ON YOUR FORKLIFT

2) Hose reel and bracket

Type	Reel diameter	Max hose length	Hose type	REF
1 Complete kit				
RH*	280 mm	3,91 m	Double synflex 1/4"	107TA3683
LH**	280 mm	3,91 m	Double synflex 1/4"	107TA3684

- 2 [REF 107TA3678](#) - RH reel (without hoses)*
 - [REF 107TA3679](#) - LH reel (without hoses)**
 - 3 [REF 107TA3681](#) - Hose, end connection 7/16" JIC*/**
 - 4 [REF 107TA3680](#) - Fitting*/** (4 required)
 - 5 [REF 107TA3682](#) - Mounting bracket*/**
- Max lifting height: 6,3 m (duplex mast), 4,8 m (triplex mast)
 * Kit included for RH, ** Kit included for LH



Type	Reel diameter	Max hose length	Hose type	REF
1 Complete kit				
RH*	330 mm	4,57 m	Double synflex 3/8"	107TA3676
LH**	330 mm	4,57 m	Double synflex 3/8"	107TA3677

- 2 [REF 107TA3673](#) - RH reel (without hoses)*
 - [REF 107TA3674](#) - LH reel (without hoses)**
 - 3 [REF 107TA3675](#) - Hose, end connection 9/16" JIC*/**
 - 4 [REF 107TA3668](#) - Fitting*/** (4 required)
 - 5 [REF 107TA3670](#) - Mounting bracket*/**
- Max lifting height: 7,1 m (duplex mast), 5,5 m (triplex mast)
 * Kit included for RH, ** Kit included for LH



Type	Reel diameter	Max hose length	Hose type	REF
1 Complete kit				
RH*	410 mm	7,62 m	Double synflex 3/8"	107TA3671
LH**	410 mm	7,62 m	Double synflex 3/8"	107TA3672

- 2 [REF 107TA3666](#) - RH reel (without hoses)*
 - [REF 107TA3667](#) - LH reel (without hoses)**
 - 3 [REF 107TA3669](#) - Hose, end connection 9/16" JIC*/**
 - 4 [REF 107TA3668](#) - Fitting*/** (4 required)
 - 5 [REF 107TA3670](#) - Mounting bracket*/**
- Max lifting height: 13 m (duplex mast), 9,81 m (triplex mast)
 * Kit included for RH, ** Kit included for LH



Hose reel bracket right
[REF 161TA5785](#)

Hose reel bracket left
[REF 161TA5786](#)



3) Switch
[REF 146TA6446](#)

4) Swivel
[REF 135TA9669](#)



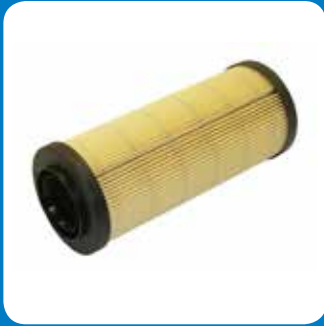
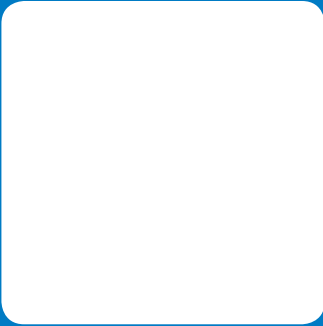
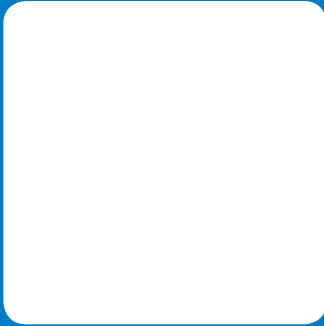

10

HYDRAULIC FILTERS



HYDRAULIC FILTERS



At TVH we have an extensive range of filters such as paper and synthetic filters, oil, air and hydraulic filters. Furthermore Brands we supply: **Argo Hytos, Donaldson, Hydac, Mahle, Parker**

Do you prefer looking up the references online? Then go to **MyTotalSource** and have a look in **MyProductSearch** or **MyPartsFinder**.

Part Number	TY	DOSE	SP	BT	HT	RE	SE	SA	TAP	PHI	PHI	WOLV
11111111	C	300-49	01L FILTER	LAPE	33.31	118.3	345	340	1.50 UNF	14	50	
11111112	C	300-49	01L FILTER	LAPE	33.31	118.3	345	340	1.50 UNF	14	50	
11111113	C	300-49	01L FILTER	HYDRAULIC	33.31	118.3	345	340	1.50 UNF	14	50	
11111114	C	300-49	01L FILTER	HYDRAULIC	33	118	340	340	1.50 UNF	14	50	
11111115	C	300-49	01L FILTER	HYDRAULIC	17.44	77	341	341	1.50 UNF	14	50	
11111116	C	300-49	01L FILTER	HYDRAULIC	22.05	118	341	341	1.50 UNF	14	50	
11111117	C	300-49	01L FILTER	HYDRAULIC	22.05	118	341	341	1.50 UNF	14	50	
11111118	C	300-49	01L FILTER	HYDRAULIC	22.05	118	341	341	1.50 UNF	14	50	
11111119	C	300-49	01L FILTER	HYDRAULIC	22.05	118	341	341	1.50 UNF	14	50	
11111120	C	300-49	01L FILTER	HYDRAULIC	22.05	118	341	341	1.50 UNF	14	50	



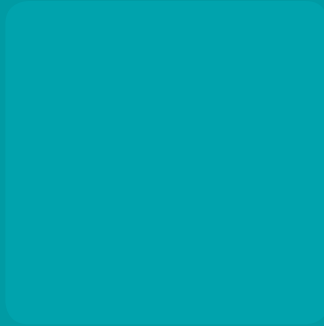
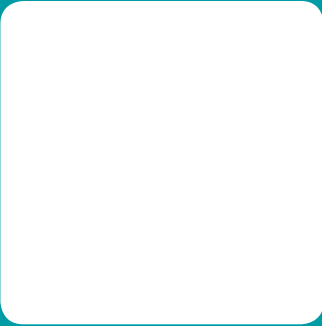
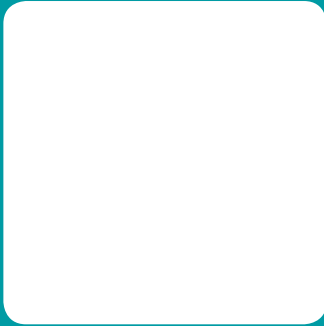
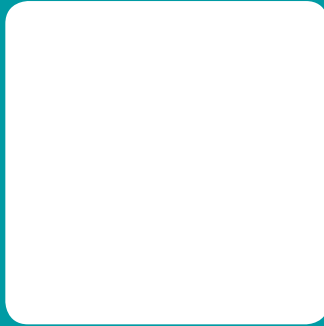
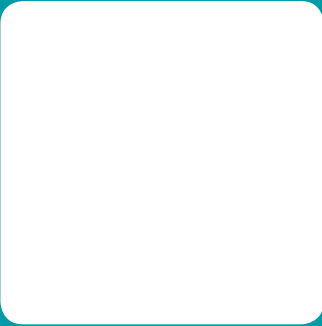

11

ACCUMULATORS



HYDRAULIC ACCUMULATORS / UNIVERSAL APPLICATION



No accumulator

- Faster driver-fatigue
- Loss of control of the vehicle
- Difficult handling of the lift lever
- Damage to the goods
- Damage and consequent downtime due to vibrations



With accumulator

- Less driver-fatigue
- Improved vehicle handling
- Easier operation of the lift lever
- Transported goods are delivered undamaged
- Decreased downtime of the truck

We recommend following capacity for our hydraulic

Forklift capacity	Accumulator capacity
500 kg > 1 T	0,5 l
+1 T > 3 T	0,75 l
+3 T > 5 T	1 l
+5 T > 12 T	2,5 - 2,8 l

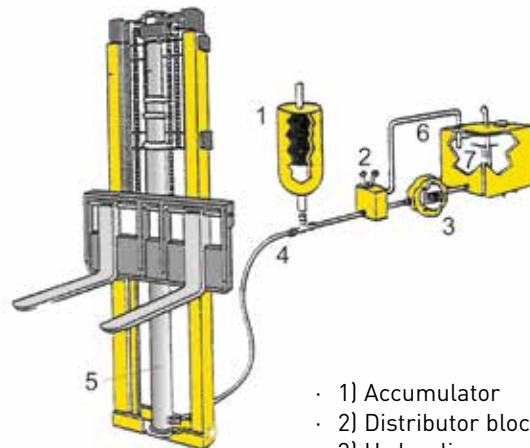

- 1) Accumulator
- 2) Distributor block
- 3) Hydraulic pump
- 4) Main hydraulic circuit
- 5) Lift cylinder
- 6) Relief circuit
- 7) Oil reservoir

We can supply all requested brands:

Bosch, Olaer, Hydac, Integral Hydraulics, Leduc,...

FOR SPECIFIC APPLICATIONS, PLEASE CONTACT OUR SALES DEPARTMENT.

* **Pre-charged** accumulators are ready for immediate use, but **cannot be shipped by air**.

When the goods have to be shipped by air, it is necessary to order the non-pre-charged execution.

These should be charged before use for proper operation.

Charge pressure is 1/3 of average working pressure of the truck.

** If you wish to replace an existing application, an inquiry for a hydraulic accumulator should always be accompanied by complete machine details and/or all references on the existing accumulator.



ACCUMULATORS



Type A: bladder



Type B: diaphragm welded



Type C: diaphragm screwed



Type D: piston

We can supply all requested brands:
Bosch, Olaer, Hydac, Saip, Hydro Leduc, Fox, Integral,...



ACCUMULATOR: 500 KG > 1 T (0,5 L)



REF 113TA2370 – Pre-charged*
REF 113TA2371 – Not pre-charged
 Connection: M18 x 1,5 internal
REF 113TA2381 – Bracket

ACCUMULATOR: + 1 T > 2 T (0,75 L)



REF 113TA2372 – Pre-charged*
REF 152TA2750 – Not pre-charged
 Connection: M33 x 1,5 external G1/2" internal
REF 113TA2382 – Bracket

ACCUMULATOR: + 2 T > 3 T (0,75 L)



REF 113TA2374 – Pre-charged*
REF 152TA2751 – Not pre-charged
 Connection: M33 x 1,5 external G1/2" internal
REF 113TA2383 – Bracket

ACCUMULATOR: + 3 T > 5 T (1 L)



REF 113TA2376 – Pre-charged*
REF 111TA6198 – Not pre-charged
 Connection: 3/4 BSP-14 internal
REF 113TA2382 – Bracket

ACCUMULATOR: + 5 T > 8 T (2,8 L)



REF 113TA2377 – Pre-charged*
REF 152TA2752 – Not pre-charged
 Connection: M22 x 1,5 internal
REF 113TA2384 – Bracket

ACCUMULATOR: + 8 T > 12 T (2,5 L)



REF 113TA2379 – Pre-charged*
REF 113TA2380 – Not pre-charged
 Connection: G1" 1/4 internal
REF 113TA2382 – Bracket



TECHNICAL DETAIL: ACCUMULATOR

Group
03-06-03-00



Customer details

Type machine: Price inquiry
Serial n° machine: Order

CODE: TY-AC x L1 x D1 x L2 x L3 x L4 x TA1 x Pm1 x Pi1 x TA2 x Pm2 x Pi2 x TY-VE x TA3 x Pm3 x Pi3 x L5 x TA4 x Pm4 x Pi4 x TA5 x Pm5 x Pi5 x SLW x G x BAR1 x BAR2 x LIT x MAT x MERK



- TY-AC Type of accumulator:
 - A = bladder
 - B = diaphragm welded
 - C = diaphragm screwed
 - D = piston
- L1 Total length, measured including the protective cover on the valve.
- D1 Maximum outer diameter accumulator.
- L2 Total length without protective cover.
- L3 Length connection gas side with protective cover.
- L4 Length connection gas side without protective cover.
- TA1 External thread protective cover.
- Pm1 Pitch metric.
- Pi1 Pitch per inch.
- TA2 Internal thread valve.
- Pm2 Pitch metric.
- Pi2 Pitch per inch.
- TY-VE Type of valve, see types.
- TA3 External thread valve.
- Pm3 Pitch metric.



TECHNICAL DETAIL: ACCUMULATOR



- Pi3 Pitch per inch.
- L5 Length connection fluid side.
- TA4 External thread fluid side, if present.
- Pm4 Pitch metric.
- Pi4 Pitch per inch.
- TA5 Internal thread fluid side.
- Pm5 Pitch metric.
- Pi5 Pitch per inch.
- SLW Spanner width.
- G Weight.
- BAR1 Maximum pressure.
- BAR2 Precharge pressure, in bar.
- LIT Volume in liters.
- MAT Material:
 - S = steel*
 - RVS = stainless steel*
 - CS = carbon steel*
- MERK Make of the accumulator.



TYPES OF ACCUMULATORS

Type A
Bladder

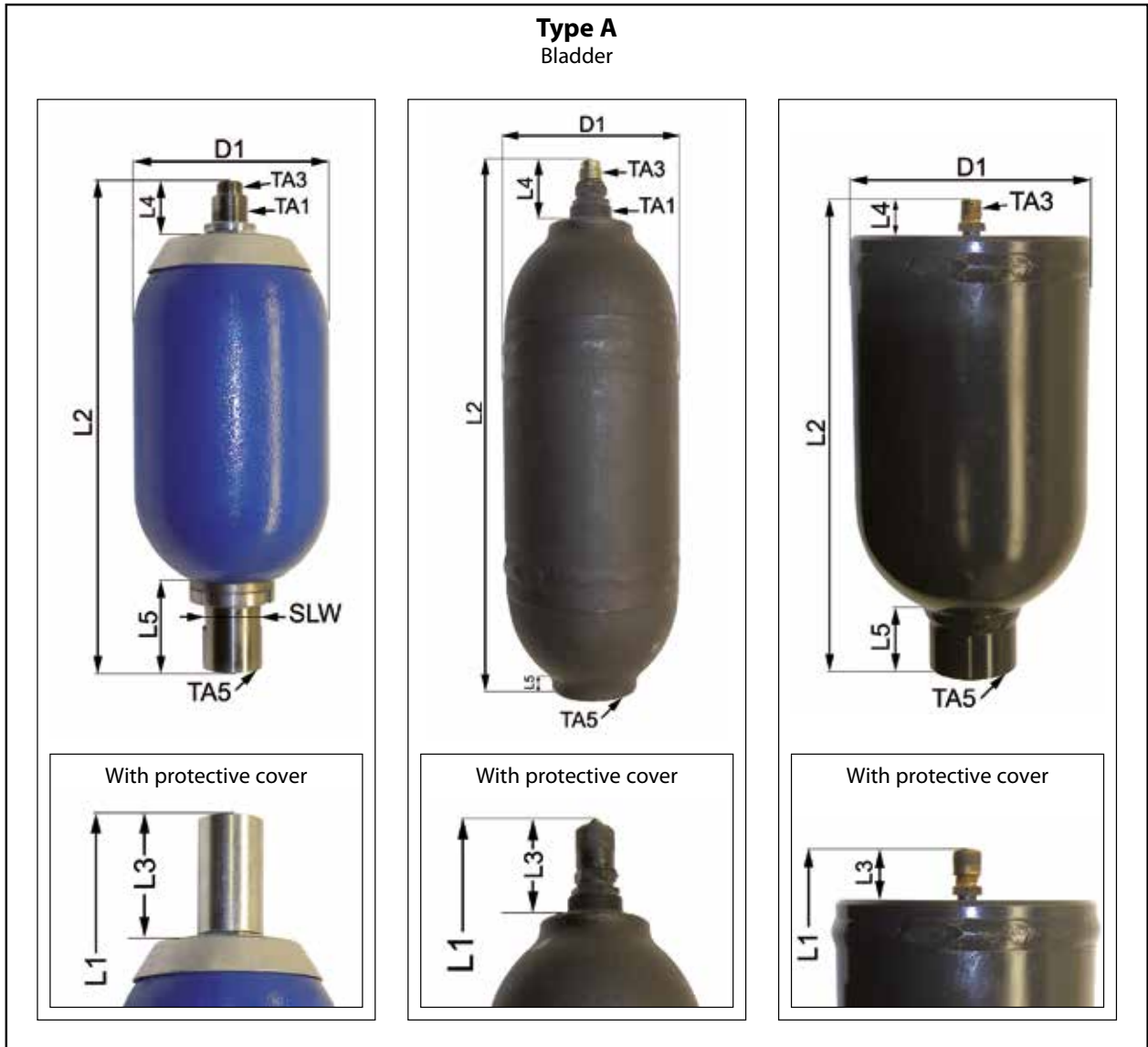



TECHNICAL DETAIL: ACCUMULATOR

TYPES OF ACCUMULATORS

Type B
Diaphragm welded

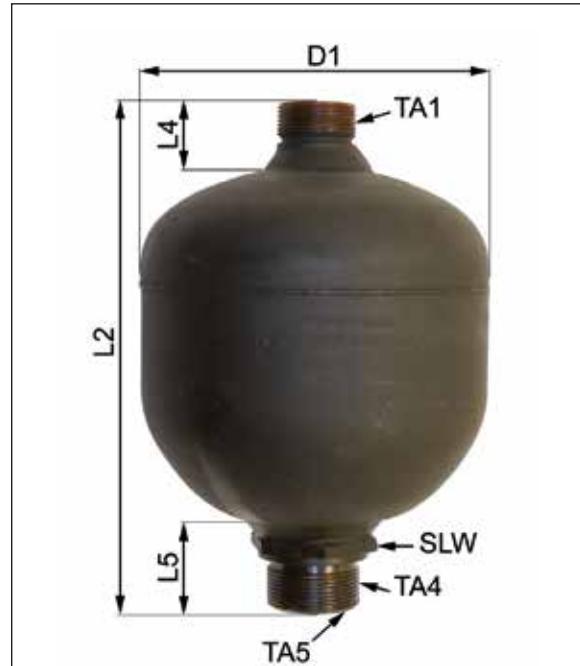
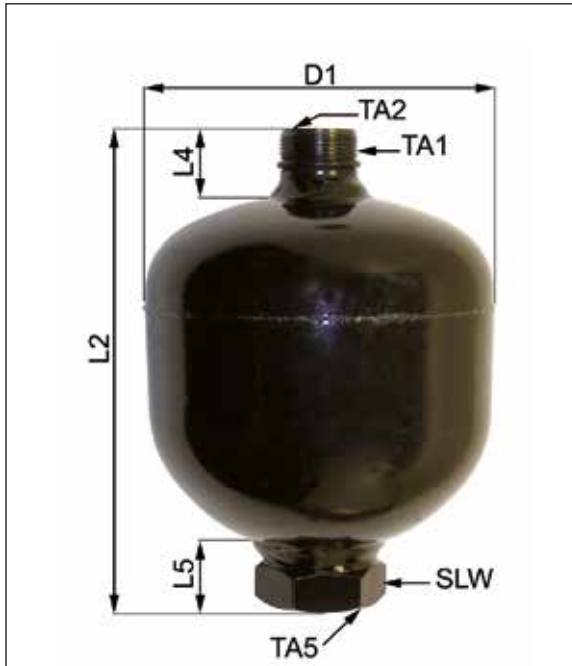



TYPES OF ACCUMULATORS

Type C
Diaphragm screwed

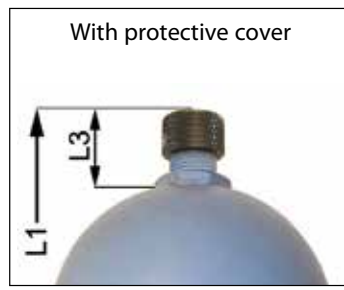
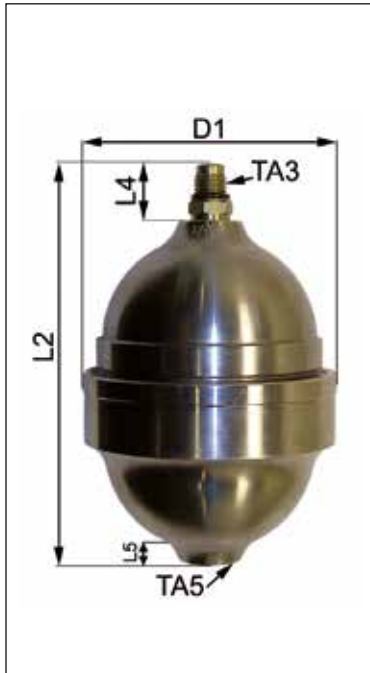



TECHNICAL DETAIL: ACCUMULATOR

TYPES OF ACCUMULATORS

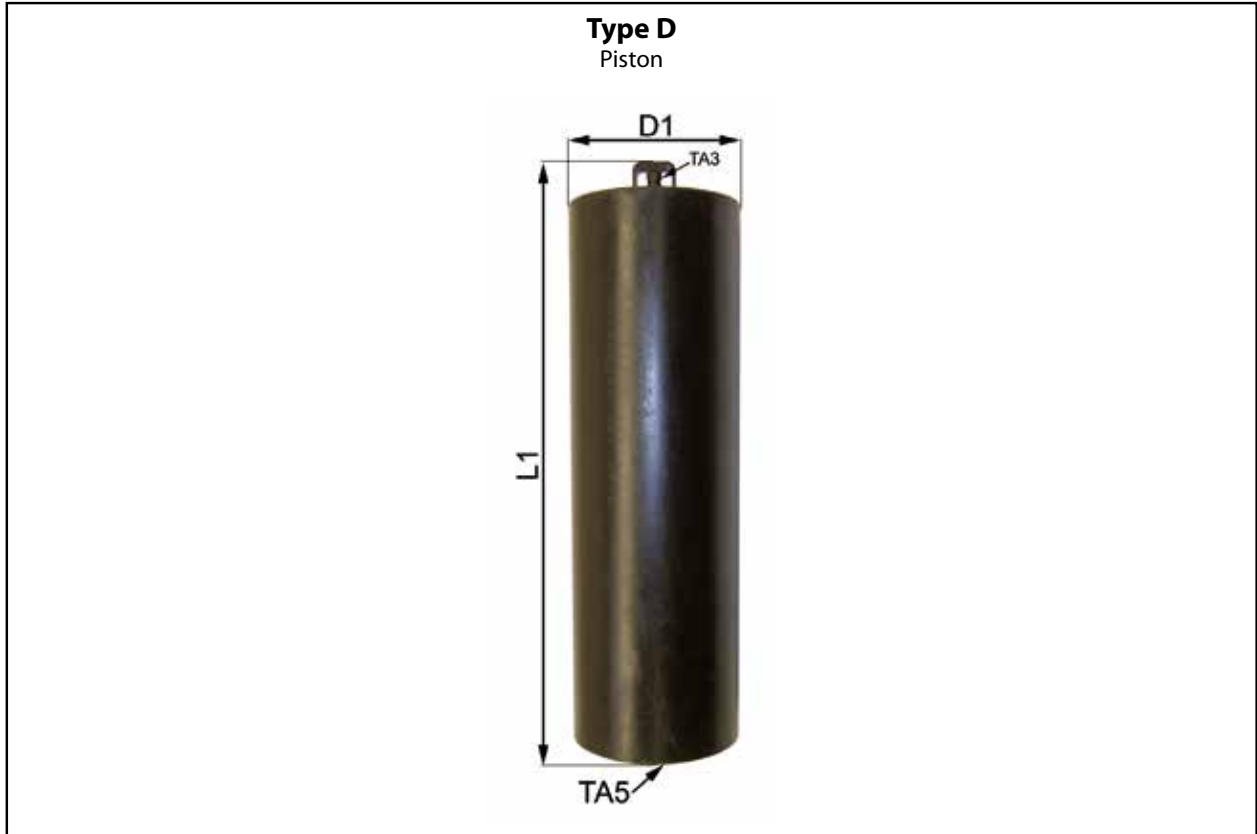

TYPE OF VALVE

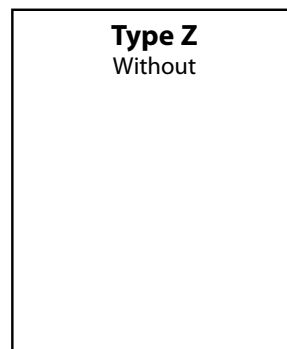
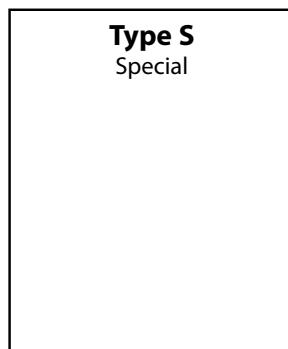



TECHNICAL DETAIL: ACCUMULATOR

Groep
03-06-03-00



Gegevens klant

Type machine:

Prijsaanvraag

Serienr. machine:

Bestelling

CODE: TY-AC x L1 x D1 x L2 x L3 x L4 x TA1 x Pm1 x Pi1 x TA2 x Pm2 x Pi2 x TY-VE x TA3 x Pm3 x Pi3 x L5 x TA4 x Pm4 x Pi4 x TA5 x Pm5 x Pi5 x SLW x G x BAR1 x BAR2 x LIT x MAT x MERK

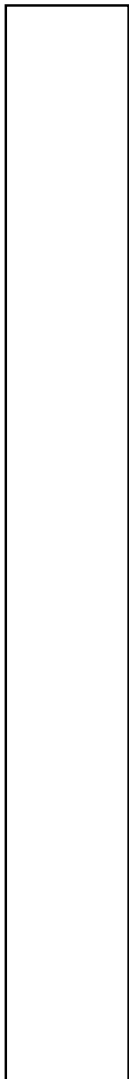

TY-AC Type accumulator:

- A = *balg*
- B = *membraan gelast*
- C = *membraan geschroefd*
- D = *zuiger*

L1 Totale lengte, gemeten met de beschermkap op de ventiel.

D1 Maximale buitendiameter accumulator.

L2 Totale lengte zonder beschermkap.

L3 Lengte aansluiting gaskant met beschermkap.

L4 Lengte aansluiting gaskant zonder beschermkap.

TA1 Uitwendig schroefdraad beschermkap.

Pm1 Pas metrisch.

Pi1 Pas per duim.

TA2 Inwendige schroefdraad ventiel.

Pm2 Pas metrisch.

Pi2 Pas per duim.

TY-VE Type ventiel, zie types.

TA3 Uitwendige schroefdraad ventiel.

Pm3 Pas metrisch.

zie Engelse technische fiche !



TECHNICAL DETAIL: ACCUMULATOR

Groupe
03-06-03-00



Données client

Type machine :

Demande de prix

No. série machine :

Commande

CODE : TY-AC x L1 x D1 x L2 x L3 x L4 x TA1 x Pm1 x Pi1 x TA2 x Pm2 x Pi2 x TY-VE x TA3 x Pm3 x Pi3 x L5 x TA4 x Pm4 x Pi4 x TA5 x Pm5 x Pi5 x SLW x G x BAR1 x BAR2 x LIT x MAT x MERK

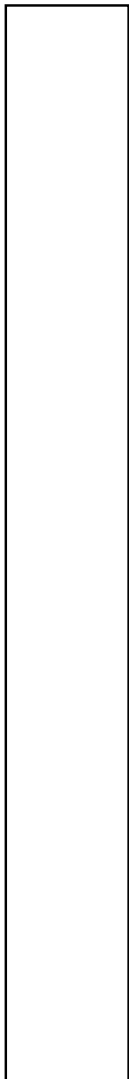

- TY-AC Type d'accumulateur :
A = accumulateur à vessie
B = accumulateur a membrane soudé
C = accumulateur a membrane vissé
D = accumulateur a piston
- L1 Longueur totale, mesurée avec le couvercle de protection sur la valve.
- D1 Diamètre extérieur maximum de l'accumulateur.
- L2 Longueur totale sans couvercle de protection.
- L3 Longueur connexion côté gaz avec couvercle de protection.
- L4 Longueur connexion côté gaz sans couvercle de protection.
- TA1 Type de filetage extérieur du couvercle de protection.
- Pm1 Pas métrique.
- Pi1 Pas en pouce.
- TA2 Type de filetage intérieur de la valve de remplissage.
- Pm2 Pas métrique.
- Pi2 Pas en pouce.
- TY-VE Type de valve de remplissage, voir types.
- TA3 Type de filetage extérieur de la valve de remplissage.
- Pm3 Pas métrique.

voir la fiche technique en Anglais.



TECHNICAL DETAIL: ACCUMULATOR

Gruppe
03-06-03-00



Kundendaten

Maschinentyp:

Preis Anfrage

Serien-Nr. Maschine:

Bestellung

CODE: TY-AC x L1 x D1 x L2 x L3 x L4 x TA1 x Pm1 x Pi1 x TA2 x Pm2 x Pi2 x TY-VE x TA3 x Pm3 x Pi3 x L5 x TA4 x Pm4 x Pi4 x TA5 x Pm5 x Pi5 x SLW x G x BAR1 x BAR2 x LIT x MAT x MERK



- TY-AC Typ Akkumulator:
 - A = Balg
 - B = Membran geschweißt
 - C = Membran geschraubt
 - D = Sauger
- L1 Gesamtlänge, gemessen mit der Schutzkappe auf dem Ventil.
- D1 Maximaler Aussendurchmesser Akkumulator.
- L2 Gesamtlänge ohne Schutzkappe.
- L3 Länge Anschluss Gasseite mit Schutzkappe.
- L4 Länge Anschluss Gasseite ohne Schutzkappe.
- TA1 Äusseres Schraubengewinde Schutzkappe.
- Pm1 Mass metrisch.
- Pi1 Mass in Zoll.
- TA2 Inneres Schraubengewinde Ventil.
- Pm2 Mass metrisch.
- Pi2 Mass in Zoll.
- TY-VE Ventiltyp, siehe Typen.
- TA3 Äusseres Schraubengewinde Ventil.
- Pm3 Mass metrisch.

Siehe technische Datenblätter auf Englisch.

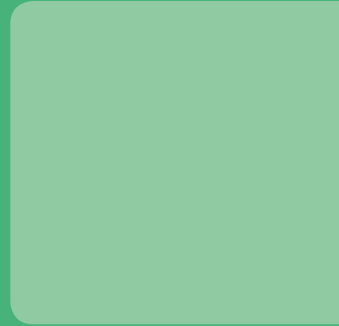

12

HYDRAULIC CYLINDERS

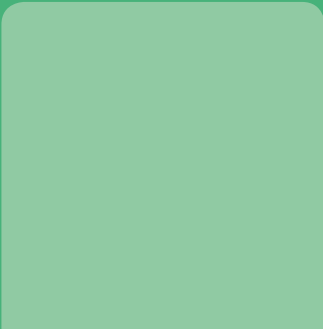



HYDRAULIC CYLINDERS



We offer a complete range of separate cylinder parts, i.e. cylinder tubes, piston shafts and rods, cylinder heads,... We can repair all cylinders. Please contact our sales department.



TEST BENCH FOR HYDRAULIC CYLINDERS

- Possibility to test on both sides – double bench
- Test tables adjustable in height
- Tilt, steering and lift cylinders are tested under different pressure conditions
- Manual or fully automatic
- Fully automatic:
 - setting the number of strokes + duration under pressure at the end of each stroke
 - testing with or without counterpressure (check for cylinder head leaks)
- Registration of the pressures inside the cylinder chambers via electronic pressure sensors
- Test report by means of a computer that visualises the pressures



Steering cylinders tested directly on the rear axle.



Fitting the cylinder on the test bench – adjustable height
Every cylinder is tested before leaving our workshop.



TECHNICAL DETAIL: HYDRAULIC CYLINDER

Group
03-08-02-00

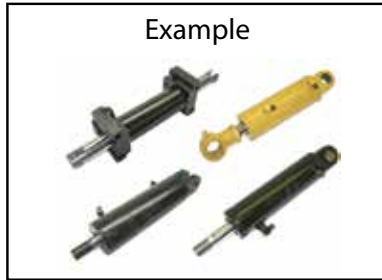

Customer details

Type machine:

Price inquiry

Serial n° machine:

Order

CODE: TY-CI x TY-VO x D2 x L2 x TA1 x TY-BU x D1 x D3 x TA2 x TY-PI x D4 x L1 x D5 x L3 x D6 x L4 x TA3 x TA4 x L5 x S



- TY-CI Type of cylinder:
ST = steering cylinder.
TL = tilt cylinder or double-acting.
HF = tift cylinder or single-acting (e.g.: HF3 = extends in 3 stages).
S = special type.
- TY-VO Type of base, see figures.
- D2 Dimension measured on the base, see figures.
- L2 Dimension measured on the base, see figures.
- TA1 Thread type base (if present), see figures.
- TY-BU Type of tube, see figures.
- D1 Dimension measured on the tube, see figures.
- D3 Dimension measured on the tube, see figures.
- TA2 Thread type of the tube (if present), see figures.
- TY-PI Type of piston shaft, see figures.
- D4 Diameter of the piston shaft, see figures.
- L1 Dimension measured on the piston shaft, see figures.
- D5 Dimension measured on the piston shaft, see figures.
- L3 Dimension measured on the piston shaft, see figures.
- D6 Dimension measured on the piston shaft, see figures.
- L4 Dimension measured on the piston shaft, see figures.
- TA3 Thread type piston shaft (if present), see figures.
- TA4 Thread type piston shaft (if present), see figures.
- L5 Total measured length of the cylinder, fully retracted, see figure.
- S Stroke of the piston shaft, see figure.



TECHNICAL DETAIL: HYDRAULIC CYLINDER

BASE TYPE

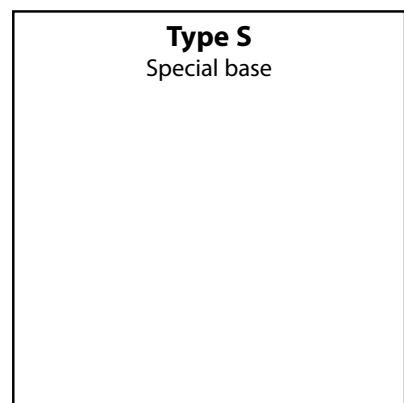
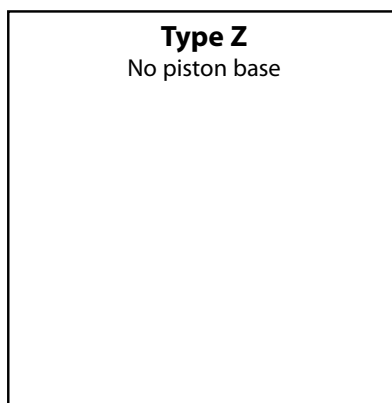
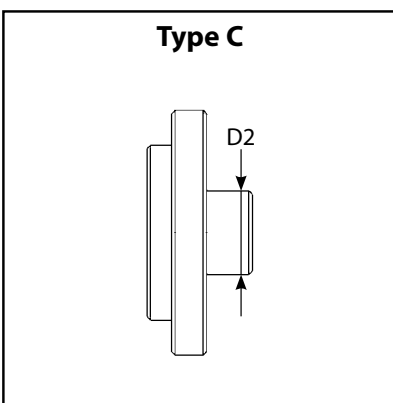
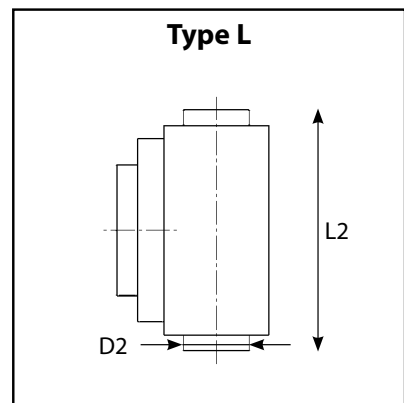
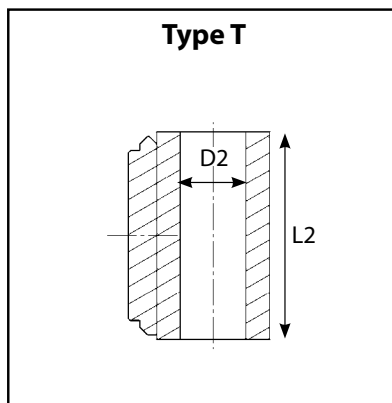
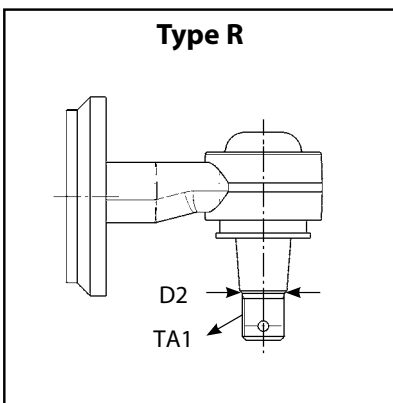
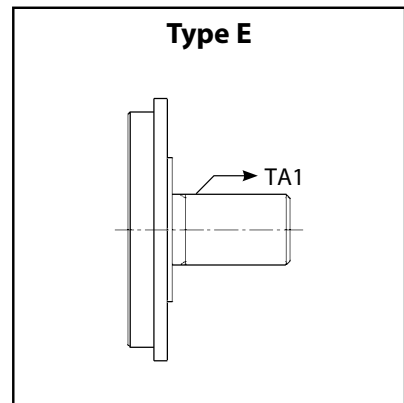
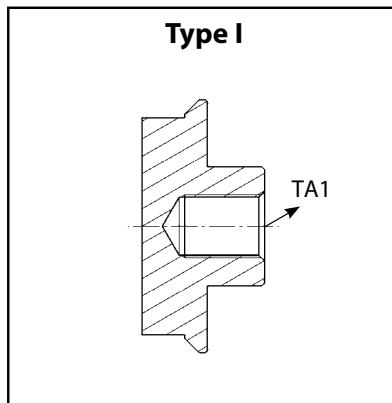
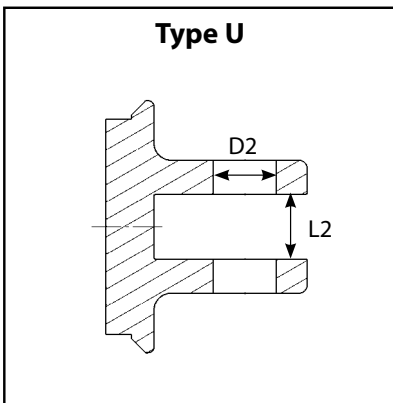
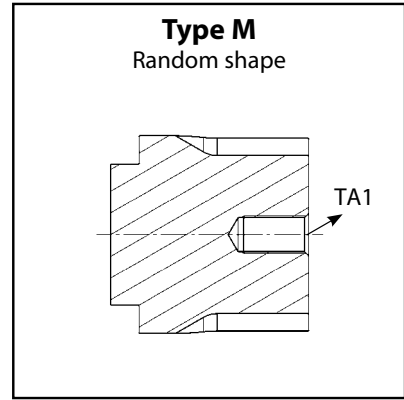
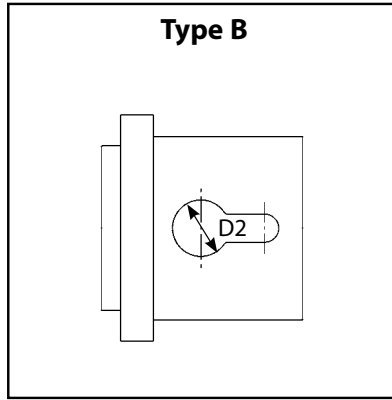
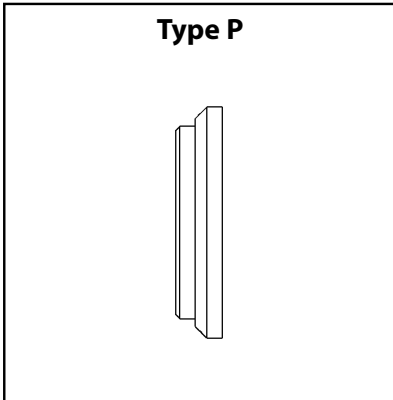



TECHNICAL DETAIL: HYDRAULIC CYLINDER

TYPE OF CYLINDER TUBE

Type I

Cylinder tube with internal thread

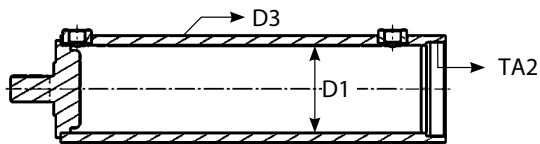

Type E

Cylinder tube with external thread

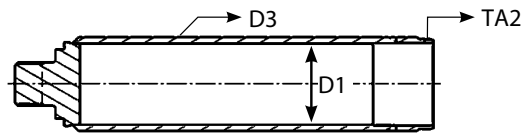

Type C

Cylinder tube with circlip fixing

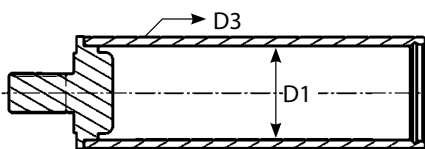

Type M

Cylinder tube with bolt fixing head

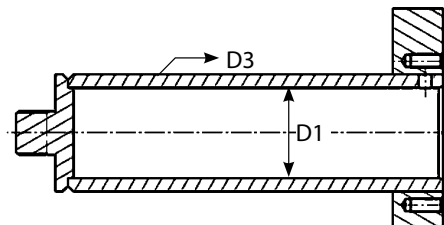

Type S

Welded cylinder tube

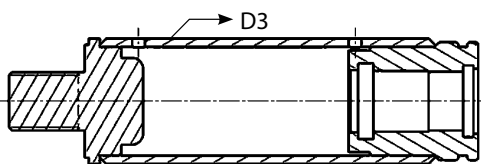

Type O

Cylinder tube without base or head

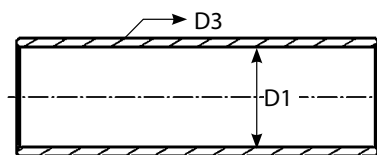



TECHNICAL DETAIL: HYDRAULIC CYLINDER

TYPE OF PISTON SHAFT

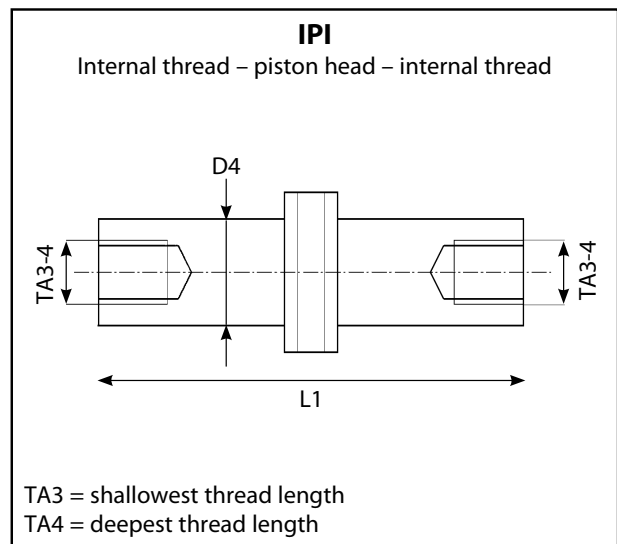
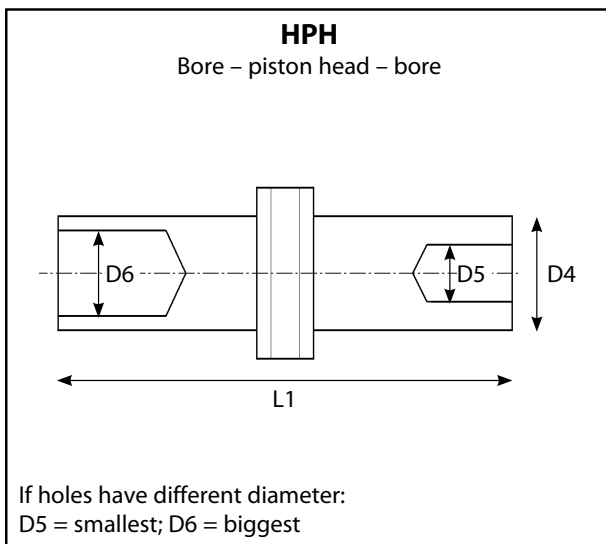
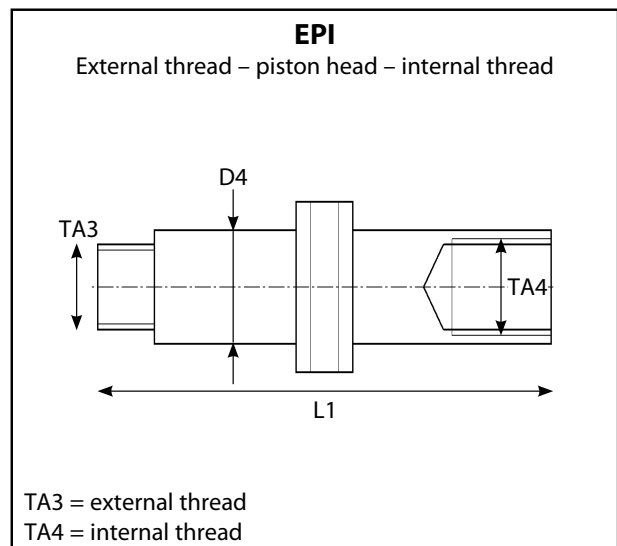
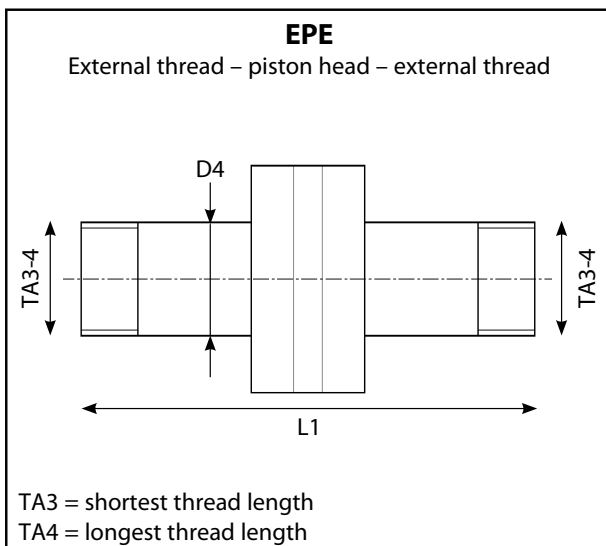
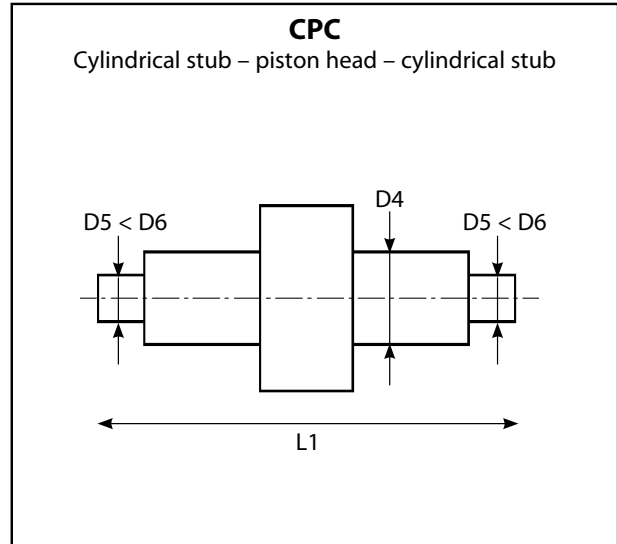
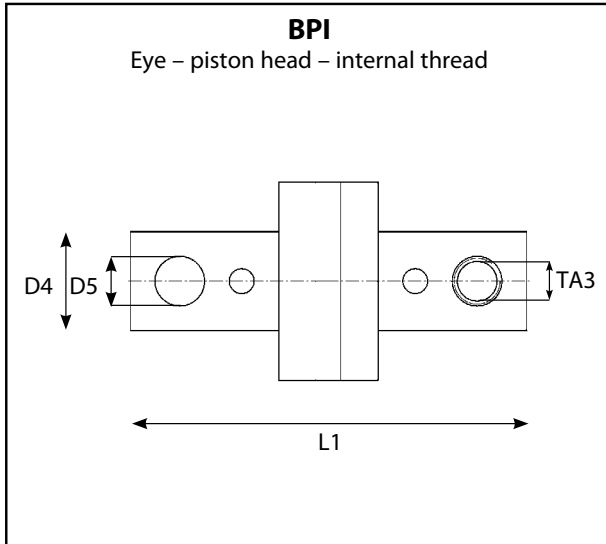



TECHNICAL DETAIL: HYDRAULIC CYLINDER

TYPE OF PISTON SHAFT

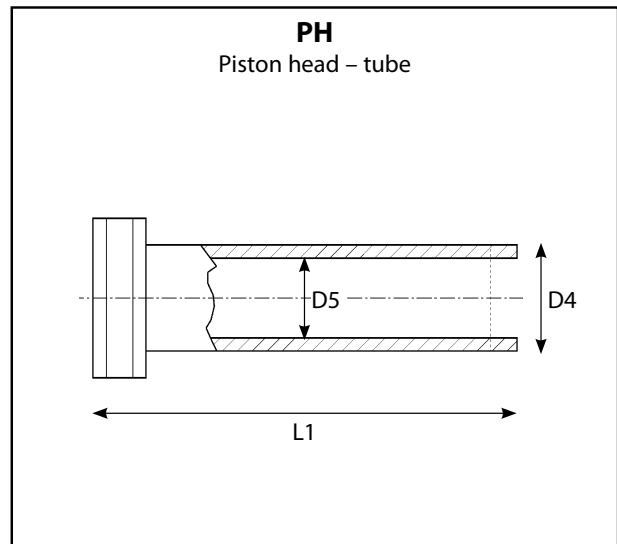
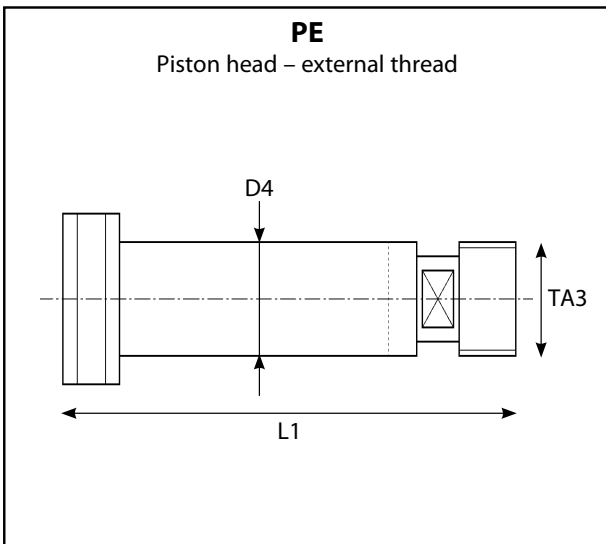
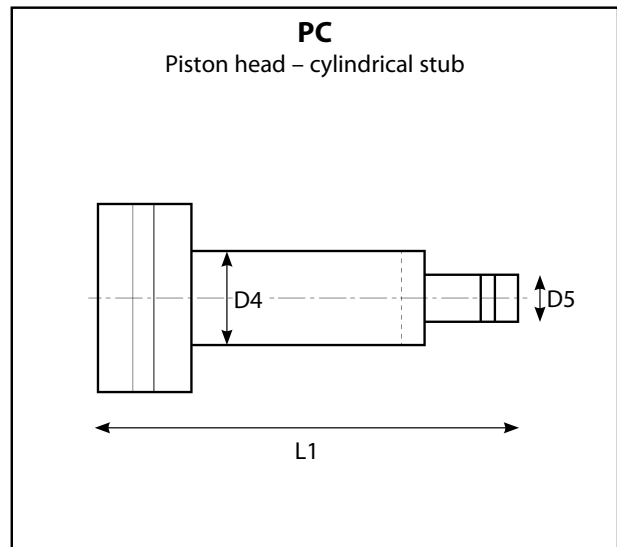
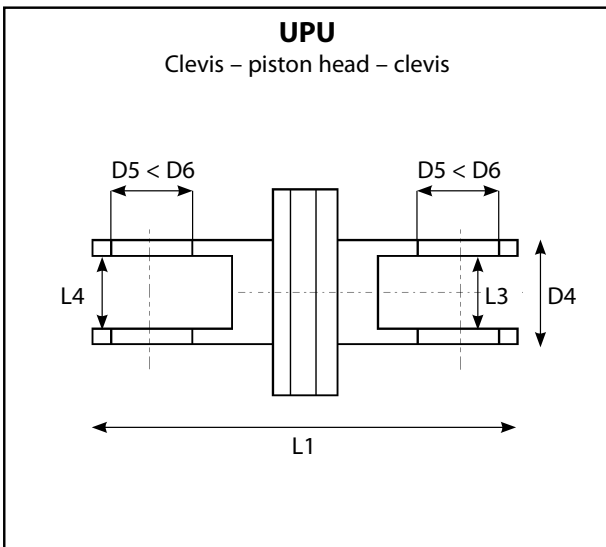
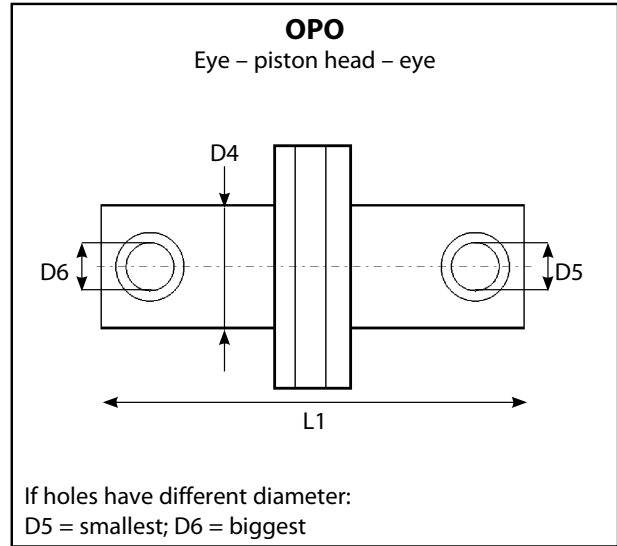
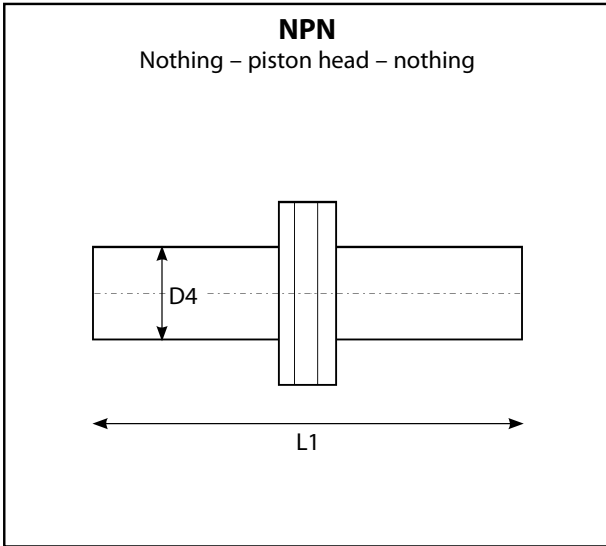



TECHNICAL DETAIL: HYDRAULIC CYLINDER

TYPE OF PISTON SHAFT

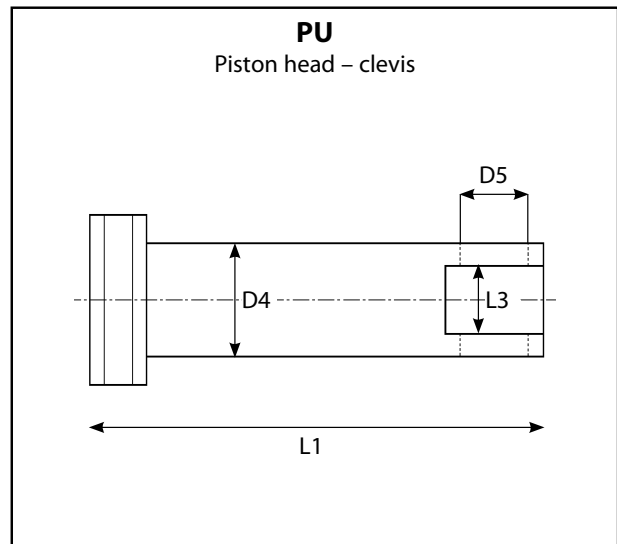
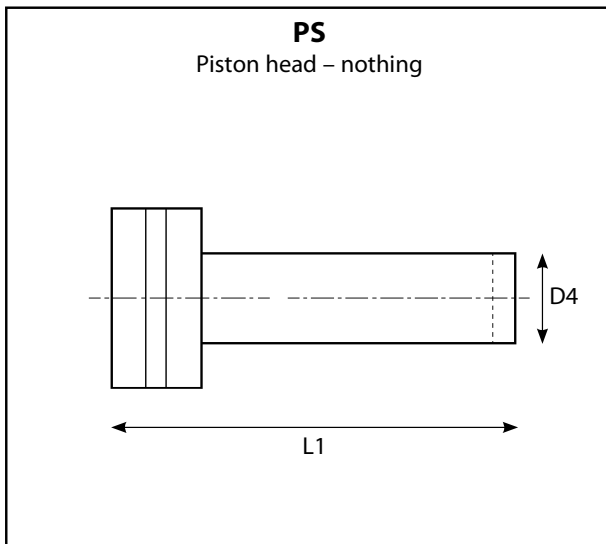
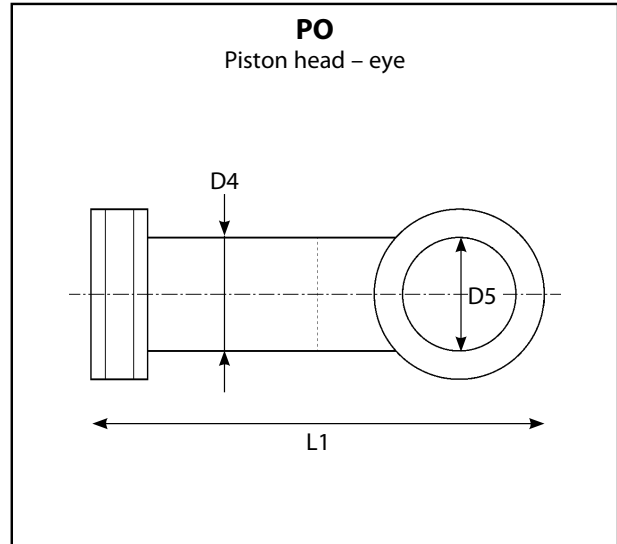
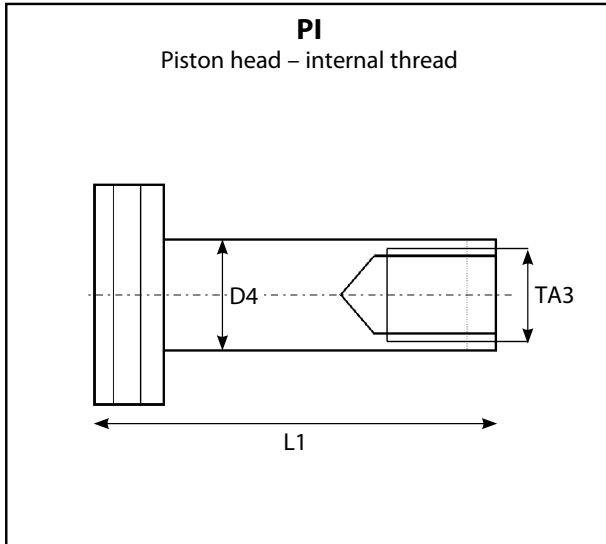

PS: For external diameters the actual size is taken, with potential present parts.
 e.g. bush: if bush = inner diameter of the bush
 spherical bearing = inner diameter of the bearing

DIMENSIONS

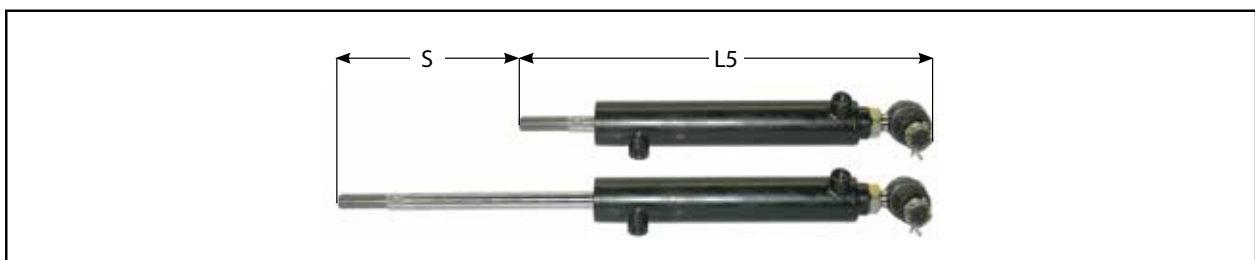



TECHNICAL DETAIL: HYDRAULIC CYLINDER

Groep
03-08-02-00



Gegevens klant

Type machine:

Prijsaanvraag

Serienr. machine:

Bestelling

CODE: TY-CI x TY-VO x D2 x L2 x TA1 x TY-BU x D1 x D3 x TA2 x TY-PI x D4 x L1 x D5 x L3 x D6 x L4 x TA3 x TA4 x L5 x S



- TY-CI Type cilinder:
ST = stuurcilinder
TL = tiltcilinder of dubbelwerkend
HF = hefcilinder of enkelwerkend (vb: HF3 = schuift uit in 3 trappen)
S = speciale type
- TY-VO Type voet, zie figuren.
- D2 Afmeting gemeten op de voet, zie figuren.
- L2 Afmeting gemeten op de voet, zie figuren.
- TA1 Draadsoort voet (indien aanwezig), zie figuren.
- TY-BU Type buis, zie figuren.
- D1 Afmeting gemeten op de buis, zie figuren.
- D3 Afmeting gemeten op de buis, zie figuren.
- TA2 Draadsoort van de buis (indien aanwezig), zie figuren.
- TY-PI Type pistonas, zie figuren.
- D4 Diameter van de pistonas, zie figuren.
- L1 Afmeting gemeten op de pistonas, zie figuren.
- D5 Afmeting gemeten op de pistonas, zie figuren.
- L3 Afmeting gemeten op de pistonas, zie figuren.
- D6 Afmeting gemeten op de pistonas, zie figuren.
- L4 Afmeting gemeten op de pistonas, zie figuren.
- TA3 Draadsoort pistonas (indien aanwezig), zie figuren.
- TA4 Draadsoort pistonas (indien aanwezig), zie figuren.
- L5 Totale overmeten lengte van de cilinder, volledig ingeschoven, zie figuur.
- S Slaglengte van de pistonas, zie figuur.

zie Engelse technische fiche !



TECHNICAL DETAIL: HYDRAULIC CYLINDER

Groupe
03-08-02-00

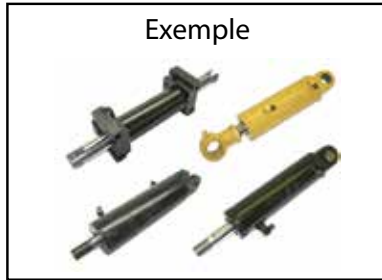

Données client

Type machine :

Demande de prix

No. série machine :

Commande

CODE : TY-CI x TY-VO x D2 x L2 x TA1 x TY-BU x D1 x D3 x TA2 x TY-PI x D4 x L1 x D5 x L3 x D6 x L4 x TA3 x TA4 x L5 x S



- TY-CI Type de cylindre :
ST = cylindre de direction.
TL = cylindre d'inclinaison ou double effet.
HF = cylindre de levage ou simple effet (ex : HF3 = 3 parties télescopiques).
S = type spécial.
- TY-VO Type d'extrémité, voir figures.
- D2 Dimension mesurée sur l'extrémité, voir figures.
- L2 Dimension mesurée sur l'extrémité, voir figures.
- TA1 Type de filetage sur l'extrémité (si présent), voir figures.
- TY-BU Type de tube de vérin, voir figures.
- D1 Dimension mesurée sur le tube, voir figures.
- D3 Dimension mesurée sur le tube, voir figures.
- TA2 Type de filetage sur le tube (si présent), voir figures.
- TY-PI Type de tige de vérin, voir figures.
- D4 Diamètre de la tige de vérin, voir figures.
- L1 Dimension mesurée sur la tige de vérin, voir figures.
- D5 Dimension mesurée sur la tige de vérin, voir figures.
- L3 Dimension mesurée sur la tige de vérin, voir figures.
- D6 Dimension mesurée sur la tige de vérin, voir figures.
- L4 Dimension mesurée sur la tige de vérin, voir figures.
- TA3 Type de filetage sur la tige de vérin (si présent), voir figures.
- TA4 Type de filetage sur la tige de vérin (si présent), voir figures.
- L5 Longueur totale du cylindre, tige de vérin entièrement rentrée, voir figure.
- S Course de la tige de vérin, voir figure.

voir la fiche technique en Anglais.



TECHNICAL DETAIL: HYDRAULIC CYLINDER

Gruppe
03-08-02-00



Kundendaten

Maschinentyp:

Preis Anfrage

Serien-Nr. Maschine:

Bestellung

CODE: TY-CI x TY-VO x D2 x L2 x TA1 x TY-BU x D1 x D3 x TA2 x TY-PI x D4 x L1 x D5 x L3 x D6 x L4 x TA3 x TA4 x L5 x S



- TY-CI Zylindertyp:
ST = Lenkzylinder.
TL = Neigezylinder oder doppelwirkend.
HF = Hubzylinder oder einzelwirkend (z.B.: HF3 = fährt aus in 3 Stufen).
S = Sondertyp.
- TY-VO Typ Fuss, siehe Abbildungen.
- D2 Abmessung auf dem Fuss gemessen, siehe Abbildungen.
- L2 Abmessung auf dem Fuss gemessen, siehe Abbildungen.
- TA1 Gewindetyp Fuss (wenn vorhanden), siehe Abbildungen.
- TY-BU Typ Rohr, siehe Abbildungen.
- D1 Abmessung auf dem Rohr gemessen, siehe Abbildungen.
- D3 Abmessung auf dem Rohr gemessen, siehe Abbildungen.
- TA2 Gewindetyp des Rohrs (wenn vorhanden), siehe Abbildungen.
- TY-PI Typ Kolbenachse, siehe Abbildungen.
- D4 Durchmesser der Kolbenachse, siehe Abbildungen.
- L1 Abmessung auf der Kolbenachse gemessen, siehe Abbildungen.
- D5 Abmessung auf der Kolbenachse gemessen, siehe Abbildungen.
- L3 Abmessung auf der Kolbenachse gemessen, siehe Abbildungen.
- D6 Abmessung auf der Kolbenachse gemessen, siehe Abbildungen.
- L4 Abmessung auf der Kolbenachse gemessen, siehe Abbildungen.
- TA3 Gewindetyp Kolbenachse (wenn vorhanden), siehe Abbildungen.
- TA4 Gewindetyp Kolbenachse (wenn vorhanden), siehe Abbildungen.
- L5 Gesamtüberemessene Länge des Zylinders, ganz eingeschoben, siehe Abbildung.
- S Schlaglänge der Kolbenstange, siehe Abbildung.

Siehe technische Datenblätter auf Englisch.

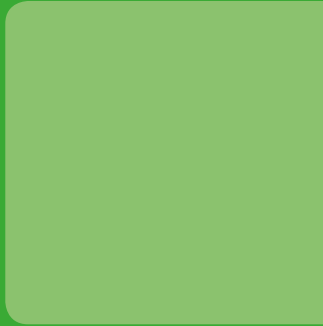
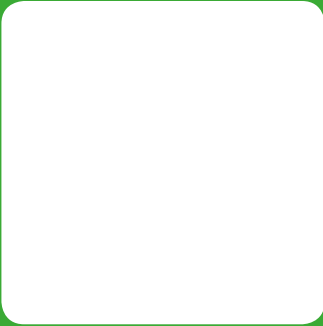
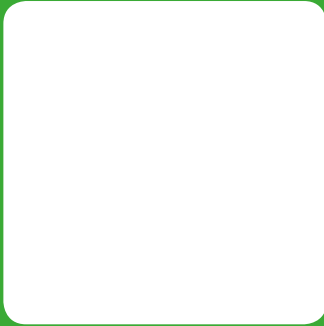
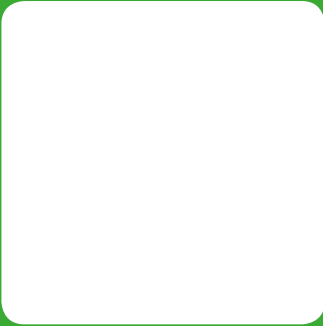

13

HYDRAULIC SEALS



HYDRAULIC SEALS

O-RING
(see page 149)

BACK-UP RING
(see page 216)

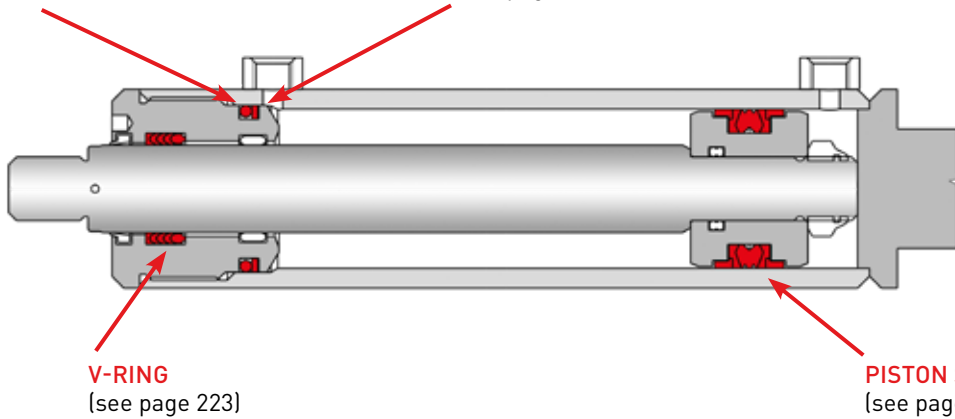

V-RING
(see page 223)

PISTON SEAL
(see page 186)

LIP SEAL
(see page 154)

GUIDE RING
(see page 199)



WIPER RING
(see page 165)

COMPOSITE SEAL
(see page 178)

GUIDE RING
(see page 199)



BONDED SEAL
(see page 229)

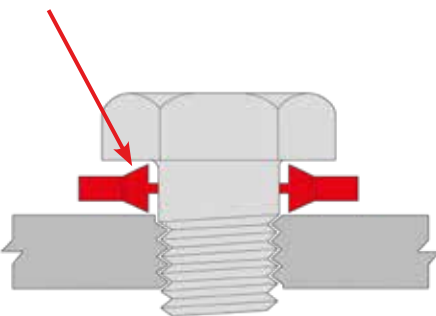

OIL SEAL
(see page 235)

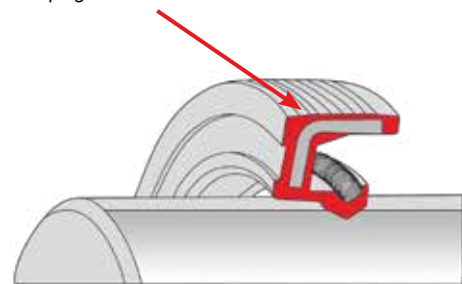



HYDRAULIC SEALS



TVH supplies a wide range of static, linear and rotary hydraulic seals. Both seals and seal kits can be modified to meet the demands of our customers. The required product can be looked up via **OEM-reference** and **product search** in **MyTotal Source**. TVH stores most seal manufacturer's products.

Seals are highly stressed components of hydraulically or pneumatically operated machines and devices, that are crucial for the functioning of these systems.

In general, seals have a lifetime which is shorter than the lifetime of the machine in which they are installed. The replacement of seals during repair and maintenance cycles is a standard procedure and accepted as well as planned by the general engineering industry.

A seal replacement due to leakage or other failures shall always include an analysis of the cause of the failure. The knowledge about the cause of the failure and the specific reaction to it will prevent or postpone the failure in the future and will give a safer, more reliable and last but not least profitable use of the machine or equipment.



STATIC SEALS

We also have boxes of o-rings and back-up rings available. Please contact our sales department for dimensions and availability.

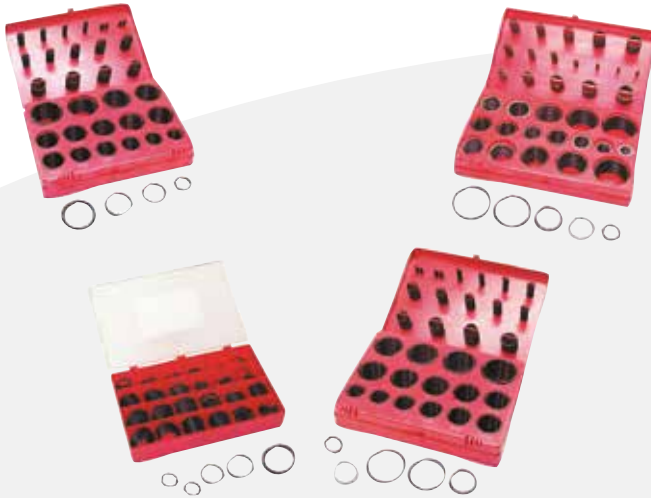

REF <u>107TA5440</u>					
Dimensions	Qty	Dimensions	Qty	Dimensions	Qty
3,0 x 2	20	11,3 x 2,4	15	15,0 x 3	10
4,0 x 2	20	12,3 x 2,4	15	18,0 x 3	10
5,0 x 2	20	13,3 x 2,4	15	19,2 x 3	10
6,0 x 2	20	14,3 x 2,4	15	24,2 x 3	10
7,0 x 2	20	15,3 x 2,4	15	39,2 x 3	10
8,0 x 2	20	16,3 x 2,4	15	44,2 x 3	10
9,0 x 2	20	17,3 x 2,4	15	49,2 x 3	10
10,0 x 2	20	18,3 x 2,4	15	39,5 x 3,5	10
9,3 x 2,4	15	19,3 x 2,4	15	44,5 x 3,5	10
10,3 x 2,4	15	20,3 x 2,4	15	49,2 x 5,7	5

REF <u>107TA5434</u>					
Dimensions	Qty	Dimensions	Qty	Dimensions	Qty
2,90 x 1,78	20	9,25 x 1,78	20	34,52 x 3,53	10
3,68 x 1,78	20	15,54 x 2,62	13	32,92 x 3,53	10
4,48 x 1,78	20	17,13 x 2,62	13	31,34 x 3,53	10
5,28 x 1,78	20	18,72 x 2,62	13	29,75 x 3,53	10
6,07 x 1,78	20	18,64 x 3,53	10	20,22 x 3,53	10
7,66 x 1,78	20	37,69 x 3,53	10	21,82 x 3,53	10
13,95 x 2,62	13	37,47 x 5,33	7	23,40 x 3,53	10
12,37 x 2,62	13	40,65 x 5,33	7	24,99 x 3,53	10
10,78 x 2,62	13	43,82 x 5,33	7	26,58 x 3,53	10
9,19 x 2,62	13	36,10 x 3,53	10	28,17 x 3,53	10

REF <u>107TA5439</u>					
Dimensions	Qty	Dimensions	Qty	Dimensions	Qty
18,0 x 2	15	25,0 x 4	15	48,0 x 4	10
20,0 x 2	15	30,0 x 4	15	50,0 x 4	10
22,0 x 3	15	32,0 x 4	15	25,0 x 5	10
25,0 x 3	15	34,0 x 4	15	30,0 x 5	10
28,2 x 3	15	36,0 x 4	15	35,0 x 5	10
30,2 x 3	15	38,0 x 4	10	40,0 x 5	10
32,2 x 3	10	40,0 x 4	10	45,0 x 5	5
36,2 x 3	10	44,0 x 4	10	50,0 x 5	5

REF <u>107TA5438</u>					
Dimensions	Qty	Dimensions	Qty	Dimensions	Qty
2,8 x 1,9	22	13,8 x 2,5	13	28 x 3,5	10
3,8 x 1,9	22	15,8 x 2,5	13	30 x 3,5	10
4,8 x 1,9	20	17,8 x 2,5	13	32 x 3,5	10
5,8 x 1,9	19	19 x 2,5	13	33 x 3,5	10
6,8 x 1,9	19	19 x 3,5	10	35 x 3,5	10
7,8 x 1,9	19	21 x 3,5	10	36 x 3,5	11
8,8 x 1,9	19	22 x 3,5	10	38 x 3,5	10
9,8 x 2,5	13	24 x 3,5	10	38 x 5,3	7
10,8 x 2,5	13	25 x 3,5	10	41 x 5,3	7
11,8 x 2,5	13	26 x 3,5	10	44 x 5,3	7

REF <u>107TA5435</u>					
Dimensions	Qty	Dimensions	Qty	Dimensions	Qty
3,0 x 1,5	20	6,3 x 2,4	15	10,0 x 3	10
5,0 x 1,5	20	8,3 x 2,4	15	12,0 x 3	10
7,0 x 1,5	20	11,3 x 2,4	15	14,0 x 3	10
9,0 x 1,5	20	13,3 x 2,4	15	16,0 x 3	10
11,0 x 1,5	20	17,3 x 2,4	15	18,0 x 3	10
6,0 x 2	20	5,0 x 2,5	15	20,2 x 3	5
8,0 x 2	20	7,0 x 2,5	15	22,2 x 3	5
10,0 x 2	20	10,0 x 2,5	15	24,2 x 3	5
12,0 x 2	20	12,0 x 2,5	15	26,2 x 3	5
14,0 x 2	20	15,0 x 2,5	15	30,2 x 3	5

REF <u>107TA5437</u>					
Dimensions	Qty	Dimensions	Qty	Dimensions	Qty
3,0 x 2	16	14,0 x 2,5	13	28,0 x 3	12
4,0 x 2	16	16,0 x 2,5	13	30,0 x 3	12
5,0 x 2	16	17,0 x 2,5	13	32,0 x 3	12
6,0 x 2	16	19,0 x 2,5	13	33,0 x 3	12
7,0 x 2	16	19,0 x 3	11	35,0 x 3	12
8,0 x 2	16	20,0 x 3	12	36,0 x 3	12
10,0 x 2	16	22,0 x 3	12	38,0 x 3	12
10,0 x 2,5	13	24,0 x 3	12	38,0 x 4	9
11,0 x 2,5	13	25,0 x 2,5	11	41,0 x 4	9
12,0 x 2,5	13	27,0 x 3	11	44,0 x 4	9

REF <u>107TA5436</u>					
Dimensions	Qty	Dimensions	Qty	Dimensions	Qty
2,90 x 1,78	20	15,60 x 1,78	10	20,29 x 2,62	5
3,68 x 1,78	20	17,16 x 1,78	5	21,89 x 2,62	5
4,48 x 1,78	20	18,77 x 1,78	5	23,47 x 2,62	5
5,28 x 1,78	20	9,19 x 2,62	15	18,64 x 3,53	5
6,07 x 1,78	20	10,78 x 2,62	15	20,22 x 3,53	5
7,66 x 1,78	20	12,37 x 2,62	15	21,82 x 3,53	5
9,25 x 1,78	20	13,95 x 2,62	15	23,40 x 3,53	5
10,82 x 1,78	15	15,54 x 2,62	10	24,99 x 3,53	5
12,42 x 1,78	15	17,13 x 2,62	10	26,58 x 3,53	5
14,00 x 1,78	10	18,72 x 2,62	10	28,17 x 3,53	5

Also available in other variations of hardness. To order o-rings, please use prefix 401 and add the inner dimensions and the thickness of the o-ring. For example: 401/045,00x03,00NBR80

All dimensions are in mm.



HYDRAULIC SEALS

MyProductSearch: Use technical details or specifications to find your necessary parts.
 No part number, brand or type of truck?
 Identify your parts by means of specifications or technical info.

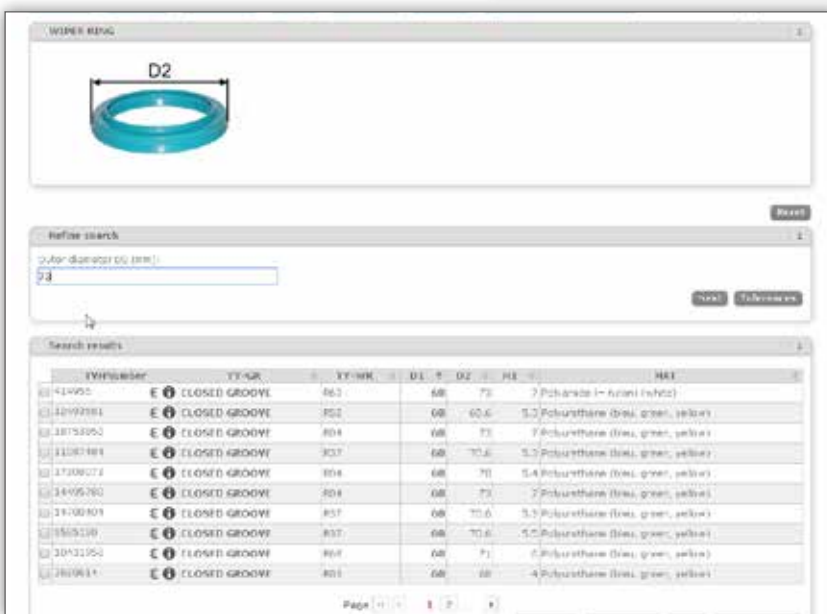
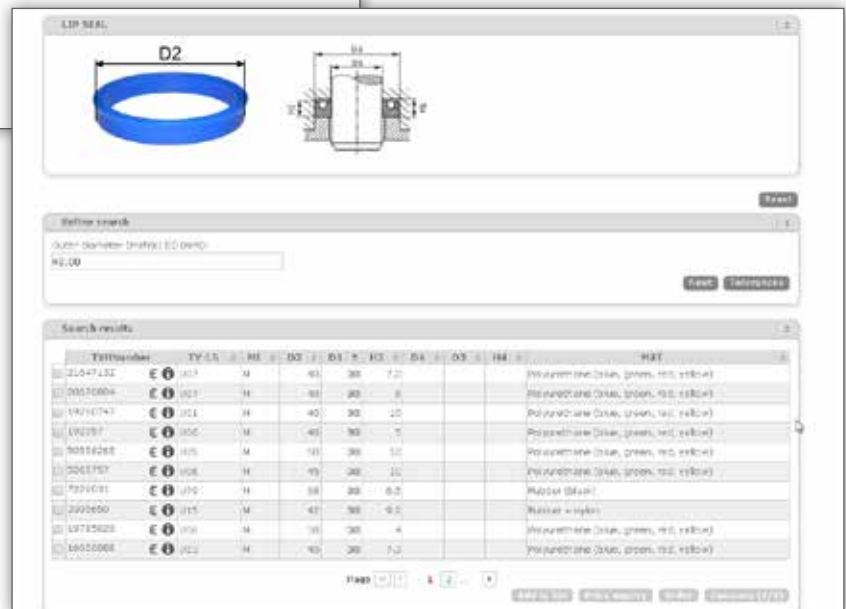
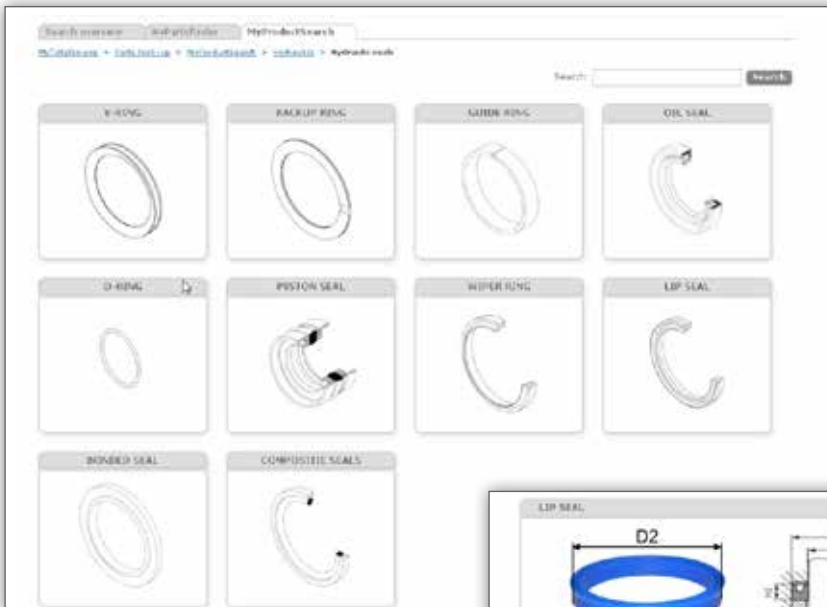



HYDRAULIC SEALS



COMPOSITE SEAL

Filter search

Outer diameter of the seal OD (mm):

Search results

TVNumber	Ø1	Ø2	H2	TY-C5	TY-GRK	POS-GRK	EV-BSNG	MAT
1170790	€ Ø 30	42.5	4.00L	Round	Outside	Closed		Polytetrafluoroethylene with brass + rubber
1170992	€ Ø 30	37.2	3.2.00L	Round	Outside	Closed		Polytetrafluoroethylene + rubber

PISTON SEAL

Filter search

Total length piston seal L1 (mm):

Build-in length guide ring L2 (mm):

Build-in length cooling ring L4 (mm):

Search results

TVNumber	Ø1	Ø2	L1	L2	L3	L4	TY	GR	GR	L4	L4	L4	Ø1P-Ø1
1719449	€ Ø 30	35	17.7	3.1			33.0.P02						5
3025172	€ Ø 30	17	28.1	3.30			15.4.P03						5
1478007	€ Ø 30	22	18.4	3.2			18.2.P10						3

BACKUP RING

Filter search

Outer diameter OD (mm):

Search results

TVNumber	TY-BU	TY-OC	Ø1	Ø2	H1	MAT
22916059	€ Ø 30.00	Closed	30	40		3 bronze + polytetrafluoroethylene
22825467	€ Ø 30.00	Open	30	35		3 bronze + polytetrafluoroethylene



HYDRAULIC SEALS



O-RING



Refine search

Quality:

Search results

TY/number	DL	D1	D2	EW
11730040	€ 0	20	3.5	18.00
14534820	€ 0	20	2.5	18.00

GROOVE RING

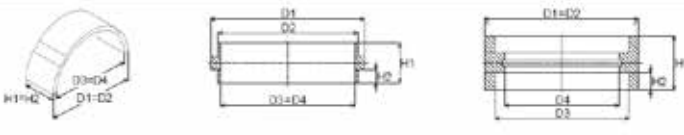

Refine search

Suggested inner diameter D1 (mm):

Suggested inner diameter D4 (mm):

Search results

TY/number	TY.F	D1	D2	D3	D4	HL	H2	H3	H4	NE	MAT
1581602	€ 0	COMPLETELY ROUND OPEN	64	52	75	15	12	15			METRIC POLYIMIDE
1581702	€ 0	COMPLETELY ROUND OPEN	64	62.6	75	15	12	15			METRIC POLYIMIDE
1581802	€ 0	COMPLETELY ROUND OPEN	64	63.8	75	15	12	15			METRIC POLYIMIDE

V-RING

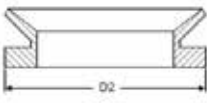

Refine search

Inner diameter D1 (mm):

Search results

TY/number	TY	DL	D1	D2	HL	H2	H3	H4
1254720	€ 0	V5	20	27	7.5	1.24	1.48	2.8
1471675	€ 0	V5	20	27	10.5	1.24	1.48	0.43



HYDRAULIC SEALS



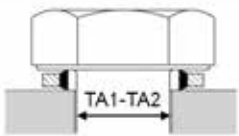

BONDED SEAL



Refine search

Type bonded seal

Search results

TV#Number	TY	D1	D2	H1	TA1	MAT1	MAT2
3054984	€ S1	20	30	1.0		NBR	steel
14097781	€ S1	29.0	30	1.5 1 1/8		NBR	steel
50564913	€ B50	30.5	43	2.5		NBR	steel
7805907	€ S1	30.7	39	2 M30		NBR	steel
3539598	€ S1	31	39	2		NBR	steel

OIL SEAL



Refine search

Inner diameter D2 (mm):

Search results

TV#Number	TY	VE	MI	D1	D2	H1	D3	D4	H3	MAT	DR	AT-GA	GLV
14719660	€ S10	3A	M	30	20	7				RUBBER	Z-NO ROTATION		YES
19588650	€ S05	3A	M	30	18	7				RUBBER	Z-NO ROTATION		NO

We can offer a complete range of seals and sealkits for any make. Supply us with measurements and type of each seal. Full truck details are needed.



O-RING

O-RING

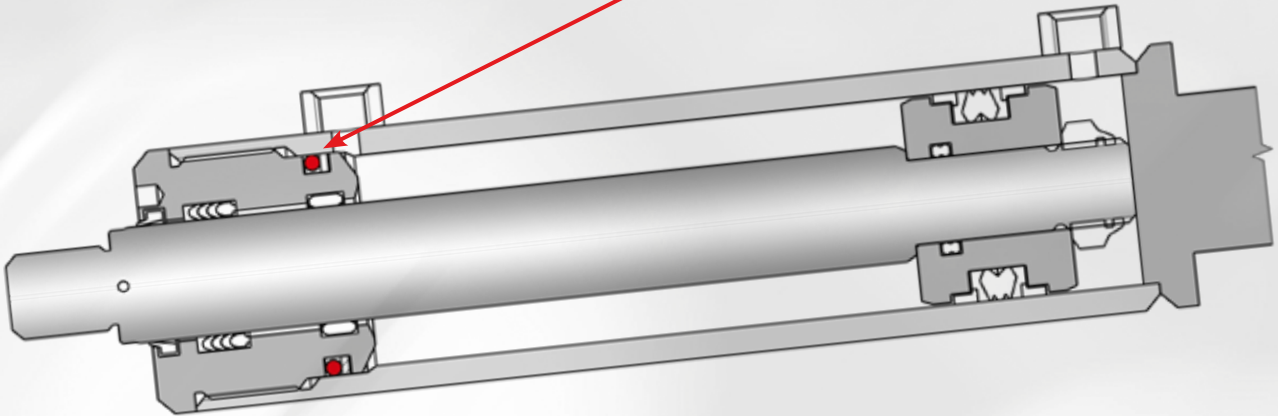

	TVHNumber	D.	#	S	KW
<input type="checkbox"/>	11930262	€ ⓘ	30	1.5	NBR90
<input type="checkbox"/>	14534838	€ ⓘ	30	2.5	NBR80

MyProductSearch: Use technical details or specifications to find your necessary parts.
No part number, brand or type of truck?
Identify your parts by means of specifications or technical info.





TECHNICAL DETAIL: O-RING

Group
03-03-04-00

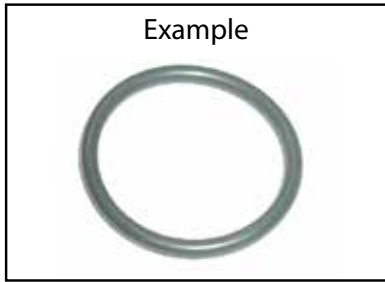

Customer details

Type machine:
Serial n° machine:

Price inquiry
Order

CODE: D x S x Kw

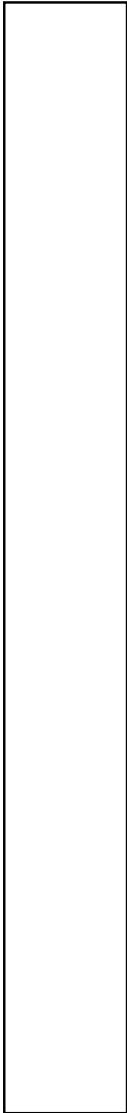

- D..... Inner diameter of the o-ring.
- S..... Diameter of the cross-section.
- Kw Quality:
 - NBR 70 = rubber soft
 - NBR 80 = rubber hard
 - NBR 90 = rubber very hard
 - FPM 80 = viton
 - ACM = special use
 - EPDM = quality of the brake fluid
 - SIL = silicone
 - F = fluorine
 - FS = fluorine silicone
 - HT = high temperature
 - PU = polyurethane
 - S = special

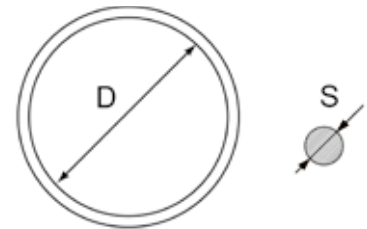



TECHNICAL DETAIL: O-RING

Groep
03-03-04-00



Gegevens klant

Type machine:
 Serienr. machine:

Prijsaanvraag
 Bestelling

CODE: D x S x Kw



- D. Inwendige diameter van de o-ring.
- S. Diameter van de doorsnede.
- Kw Kwaliteit:
 - NBR 70 = rubber zacht*
 - NBR 80 = rubber hard*
 - NBR 90 = rubber zeer hard*
 - FPM 80 = viton*
 - ACM = speciale toepassing*
 - EPDM = remolie kwaliteit*
 - SIL = silicone*
 - F = fluor*
 - FS = fluor silicone*
 - HT = hoge temperatuur*
 - PU = polyurethane*
 - S = speciaal*

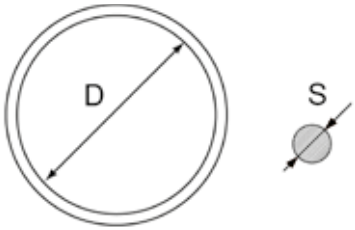



TECHNICAL DETAIL: O-RING

Groupe
03-03-04-00

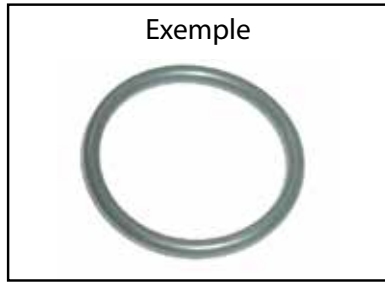

Données client

Type machine :

Demande de prix

No. série machine :

Commande

CODE : D x S x Kw

D..... Diamètre interne pour le joint o.

S..... Diamètre de la diagonale.

Kw Qualité :

- NBR 70 = caoutchouc mou*
- NBR 80 = caoutchouc dur*
- NBR 90 = caoutchouc très dur*
- FPM 80 = viton*
- ACM = application spéciale*
- EPDM = qualité d'huile de frein*
- SIL = silicone*
- F = fluor*
- FS = fluor silicone*
- HT = haute température*
- PU = polyuréthane*
- S = spécial*

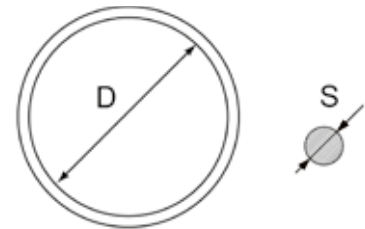



TECHNICAL DETAIL: O-RING

Gruppe
03-03-04-00



Kundendaten

Maschinentyp:
 Serien-Nr. Maschine:

Preis-anfrage
 Bestellung

CODE: D x S x Kw



- D..... Innendurchmesser des o-Ringes.
- S..... Querschnitt (durchmesser).
- Kw Materialbeschaffenheit:
 - NBR 70 = Gummi weich
 - NBR 80 = Gummi hart
 - NBR 90 = Gummi sehr hart
 - FPM 80 = Viton
 - ACM = spezieller Anwendungsbereich
 - EPDM = Bremsflüssigkeitsqualität
 - SIL = Silikon
 - F = Fluor
 - FS = Fluorsilikon
 - HT = Hohe Temperatur
 - PU = Polyurethan
 - S = Spezial

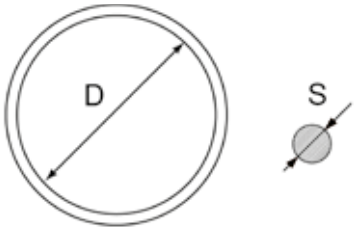



LIP SEAL

LIP SEAL

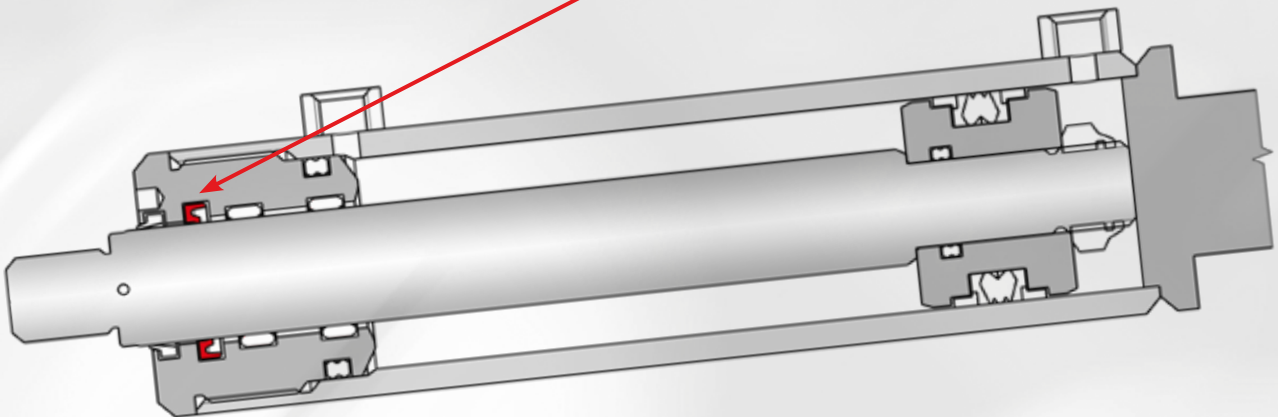

LIP SEAL

Refine search

Outer diameter (metric) D2 (mm):

Search results

TV#Number	TY-LS	MI	D2	D1	H2	D4	D3	H4	MAT
21647132	U07	M	40	30	7.2				Polyurethane (blue, green, red, yellow)
20676804	U07	M	40	30	8				Polyurethane (blue, green, red, yellow)
19260747	U01	M	40	30	10				Polyurethane (blue, green, red, yellow)
192357	U06	M	40	30	5				Polyurethane (blue, green, red, yellow)
50558265	U05	M	50	30	10				Polyurethane (blue, green, red, yellow)
5265757	U06	M	45	30	10				Polyurethane (blue, green, red, yellow)
7226031	U79	M	38	30	6.5				Rubber (black)
3395650	U15	M	42	30	9.2				Rubber + nylon
19785028	U06	M	38	30	4				Polyurethane (blue, green, red, yellow)
16656088	U23	M	40	30	7.3				Polyurethane (blue, green, red, yellow)

MyProductSearch: Use technical details or specifications to find your necessary parts.
 No part number, no brand, no type of truck?
 Identify your parts by means of specifications or technical info.





TECHNICAL DETAIL: LIP SEAL

Group
03-03-01-00

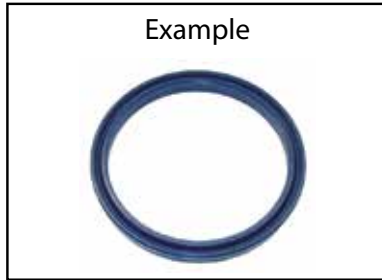

Customer details

Type machine:
Serial n° machine:

Price inquiry
Order

CODE: TY-LS x MI x D1 x D2 x H2 x D3 x D4 x H4 x MAT



- TY-LS..... Type of the lip seal:
(U1, U2, U3, ...) (see drawings)
- MI..... Unit of measurement:
M = metric
I = imperial (non metric)
- D1 Inner diameter of the lip seal (mm).
- D2 Outer diameter of the lip seal (mm).
- H2 Height of the lip seal (mm).
- D3 Inner diameter of the lip seal (inch).
- D4 Outer diameter of the lip seal (inch).
- H4 Height of the lip seal (inch).
- MAT..... Material of the lip seal:
PU = polyurethane (blue, green, red, yellow)
NBR = rubber (black)
PTFE = polytetrafluorethene (white, non transparent)
FPM = fluorcarbon rubber (matted black, brown)
PUNY = polyurethane + nylon
PUPTFE = polyurethane + polytetrafluorethene
NBRNY = rubber + nylon
FPMNY = fluorcarbon rubber + nylon
NBRPTFE = rubber + polytetrafluorethene
FPMPB = fluorocarbon rubber + polytetrafluoroethene with bronze



TECHNICAL DETAIL: LIP SEAL

TYPES

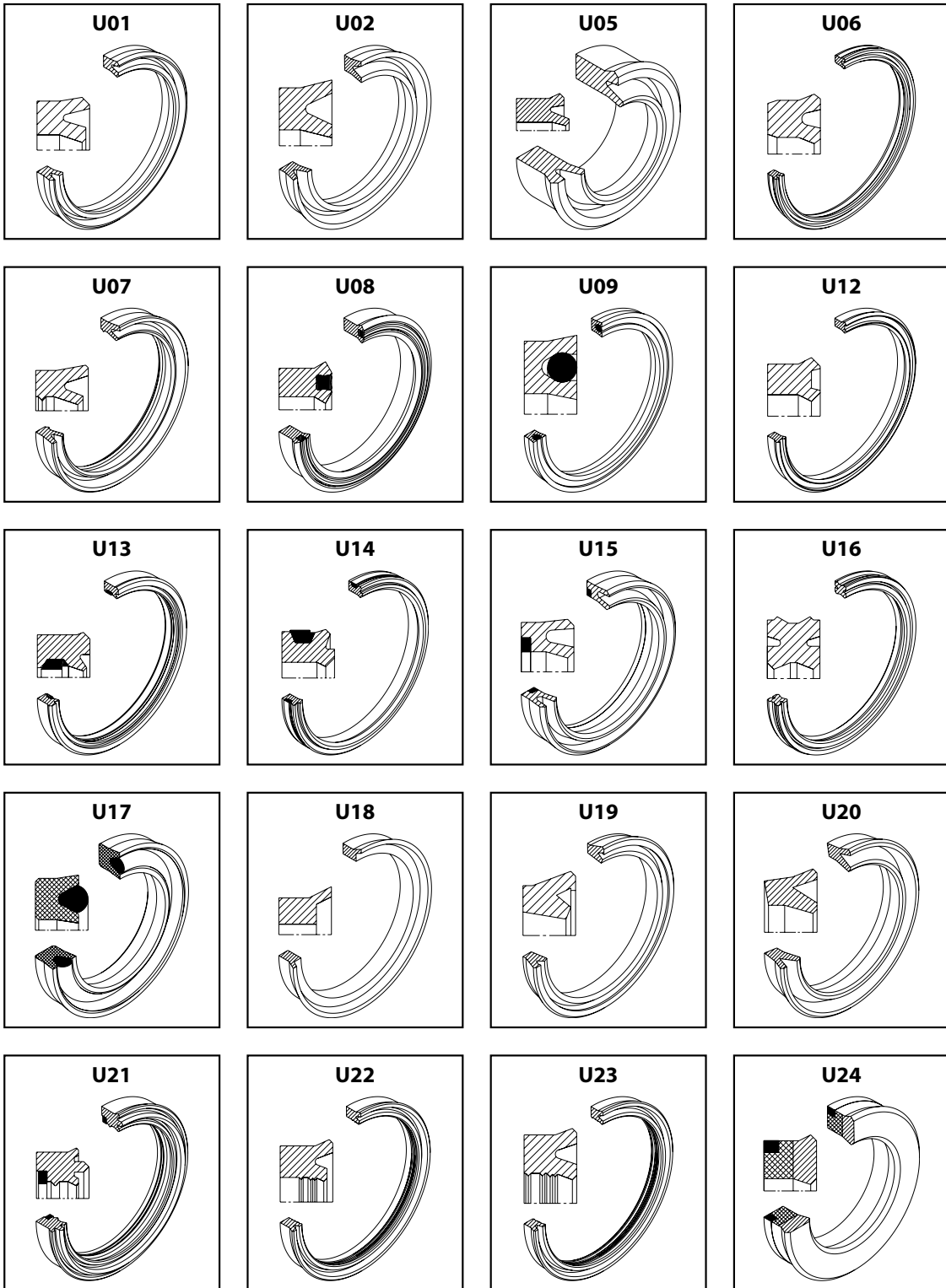



TECHNICAL DETAIL: LIP SEAL

TYPES

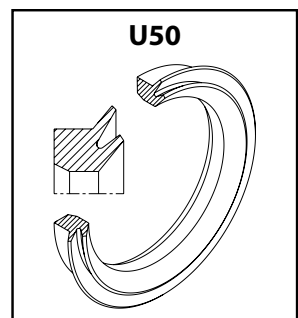
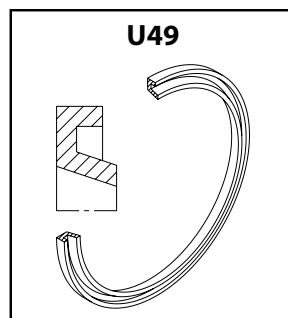
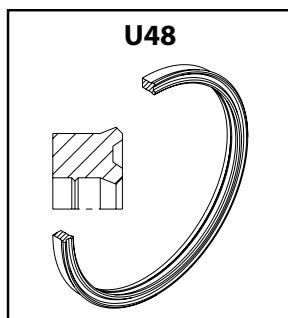
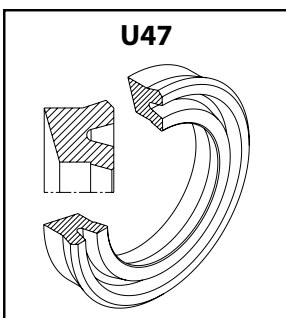
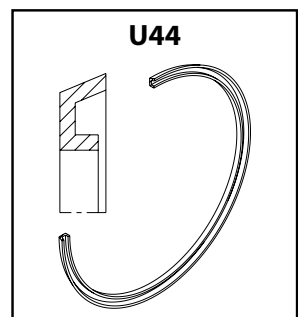
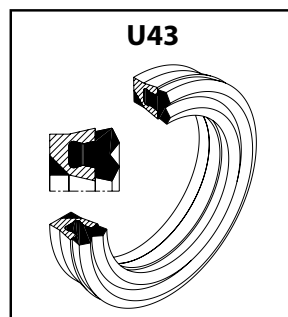
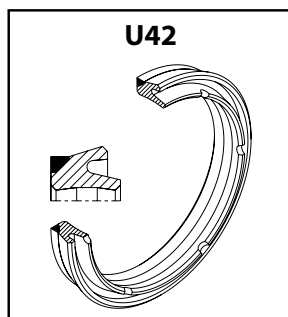
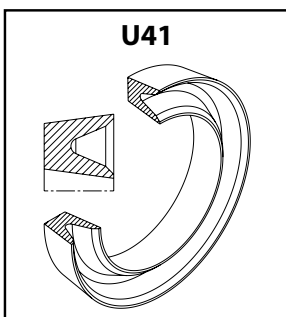
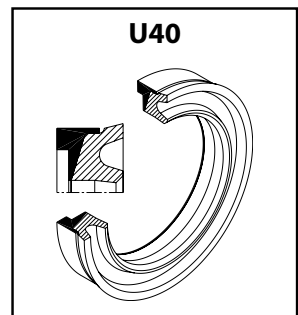
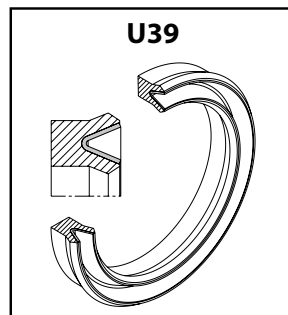
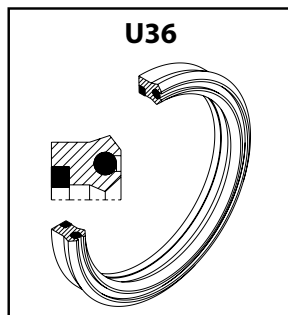
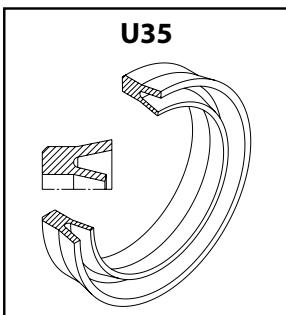
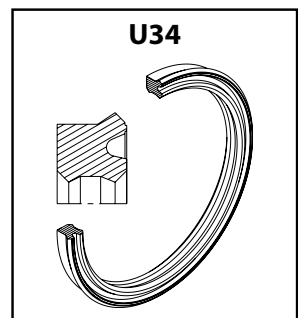
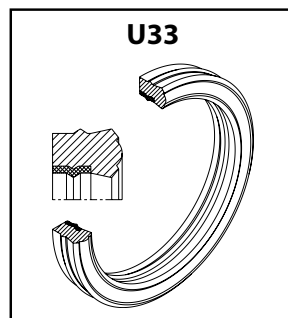
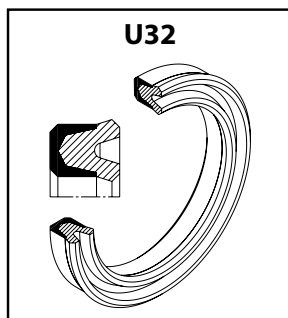
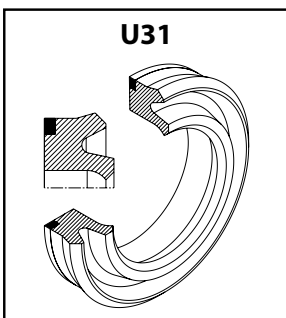
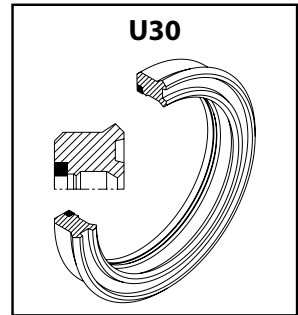
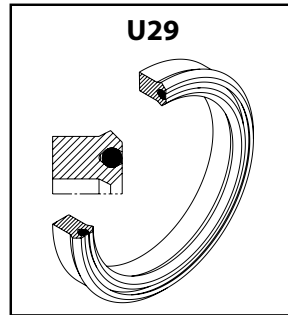
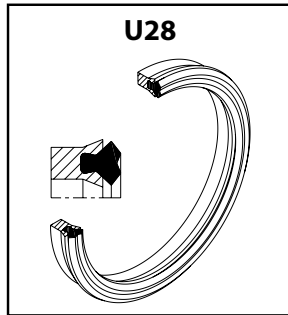
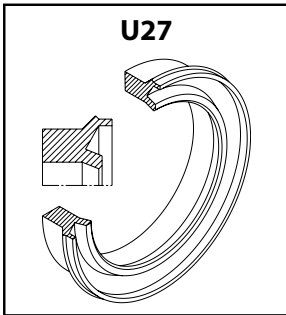



TECHNICAL DETAIL: LIP SEAL

TYPES

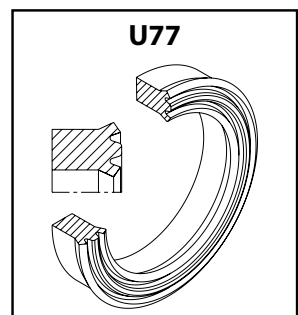
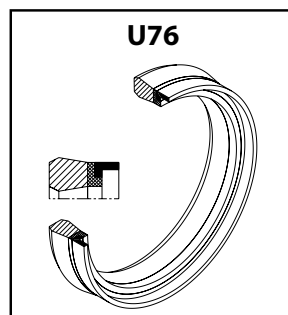
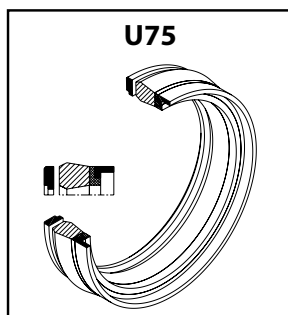
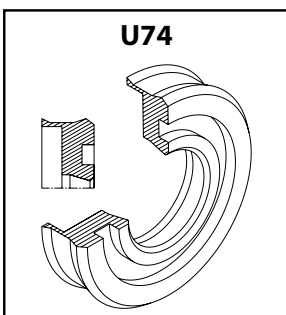
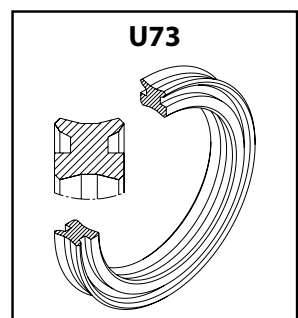
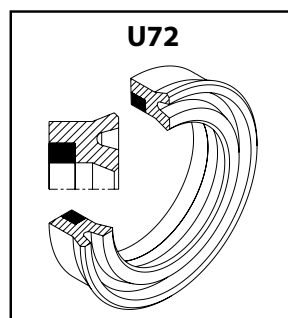
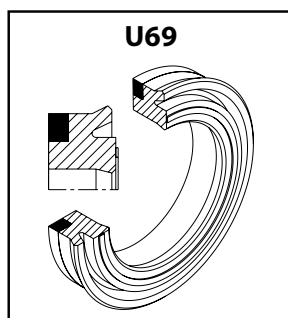
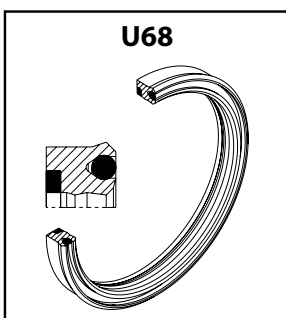
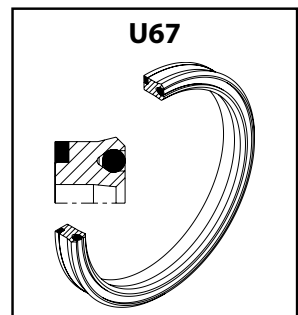
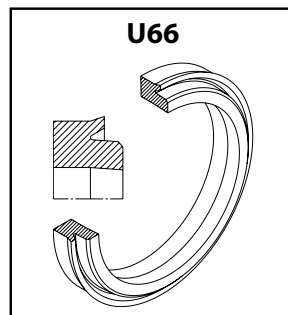
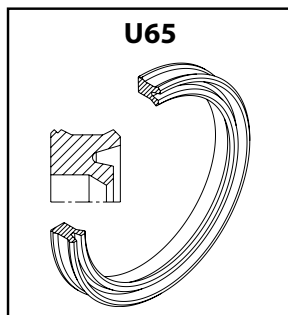
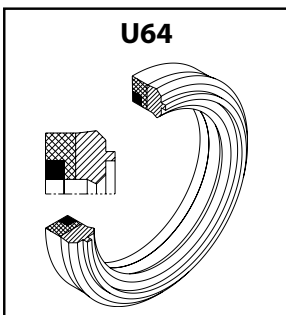
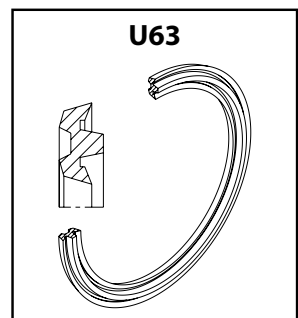
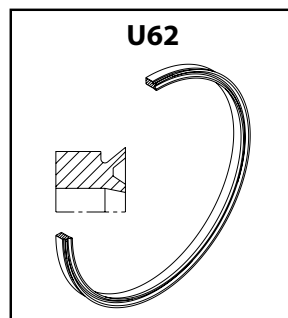
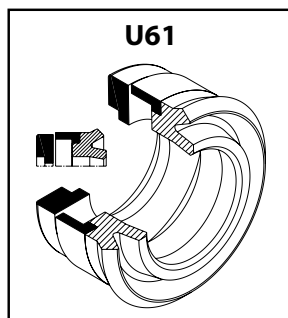
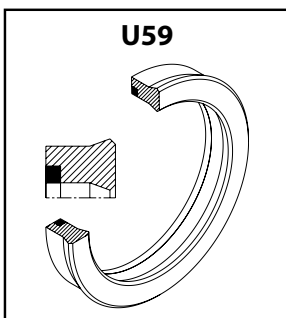
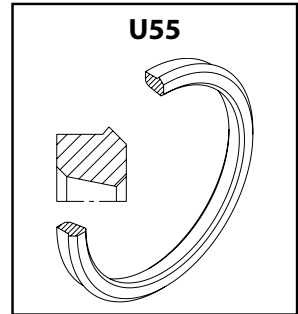
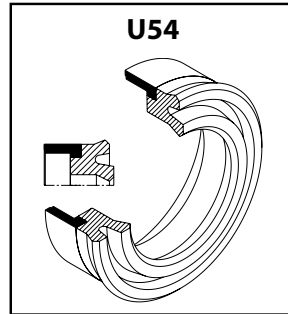
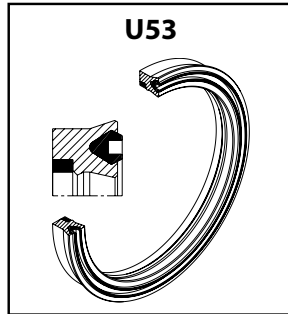
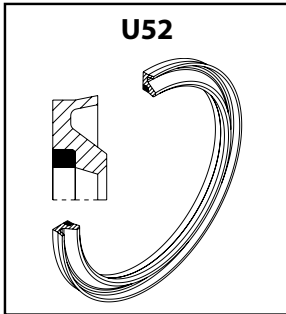



TECHNICAL DETAIL: LIP SEAL

TYPES

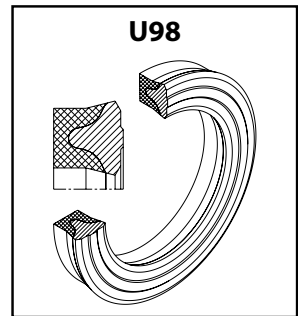
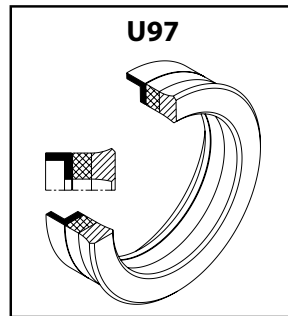
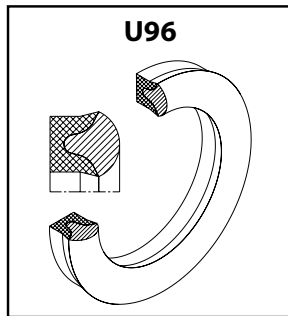
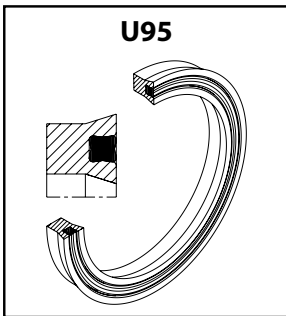
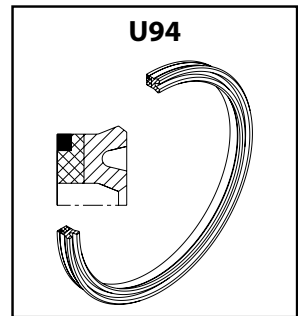
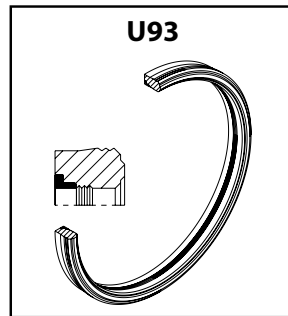
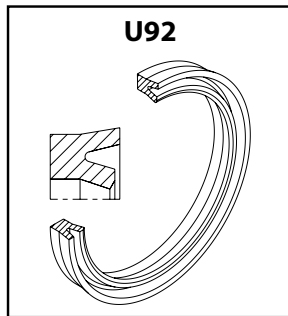
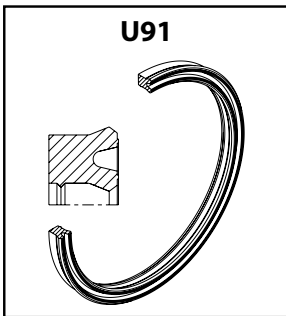
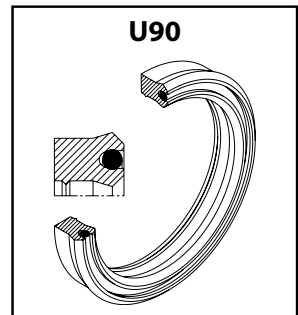
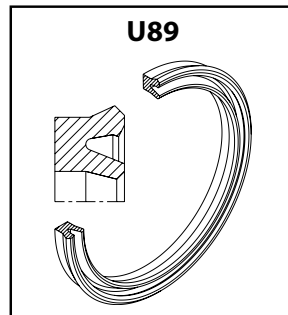
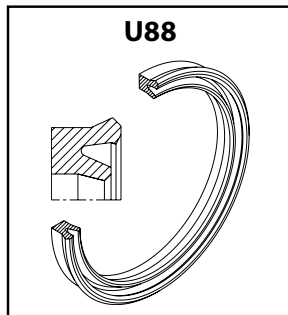
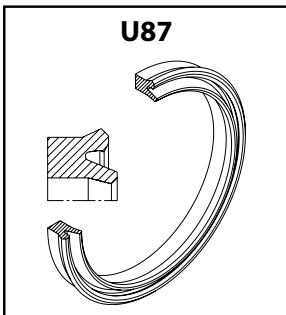
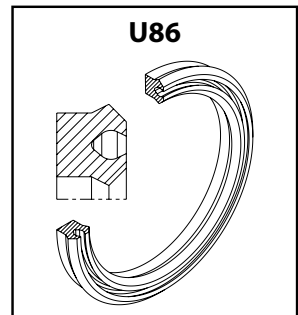
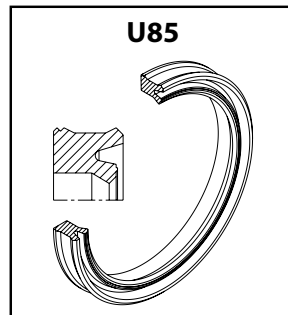
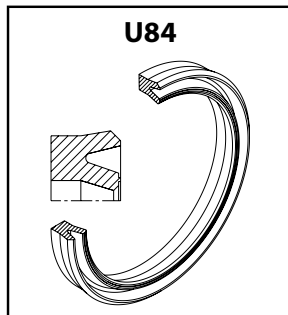
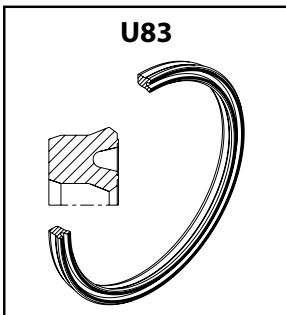
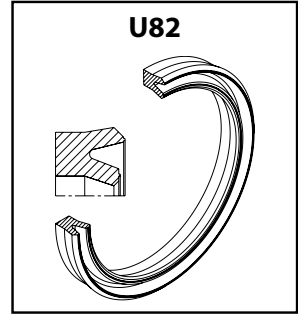
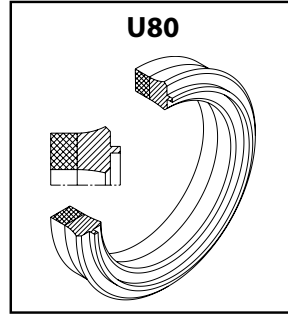
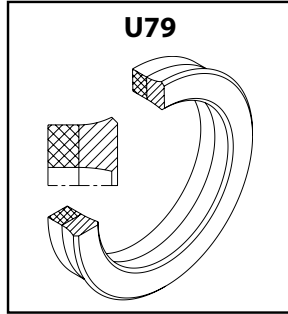
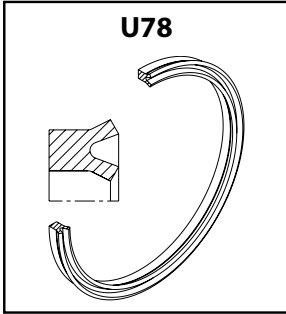



TECHNICAL DETAIL: LIP SEAL

TYPES

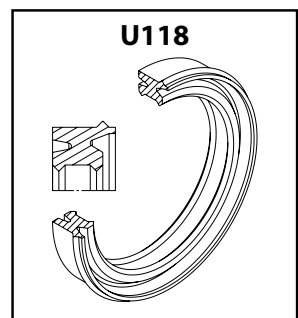
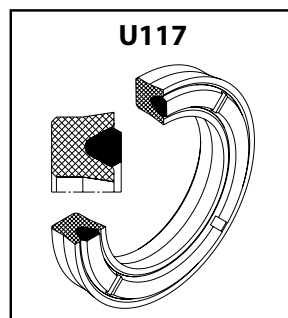
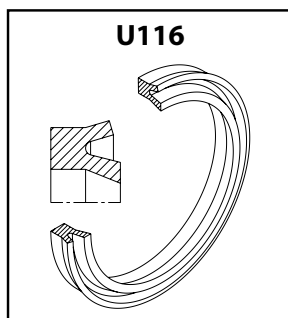
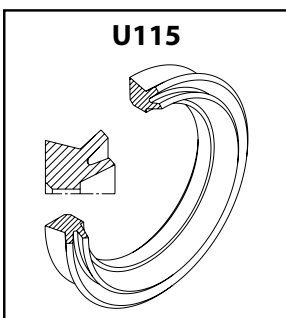
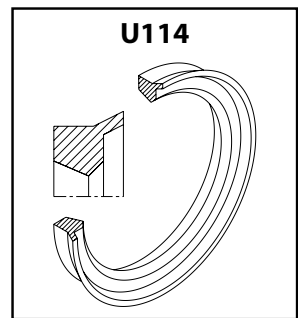
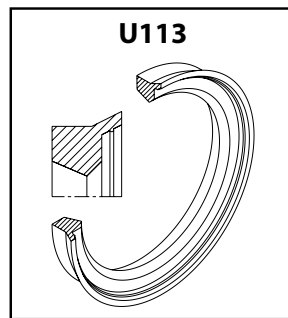
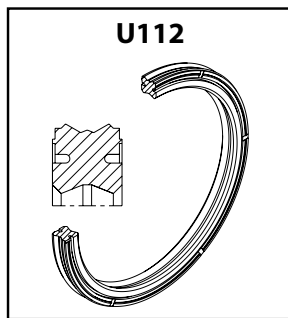
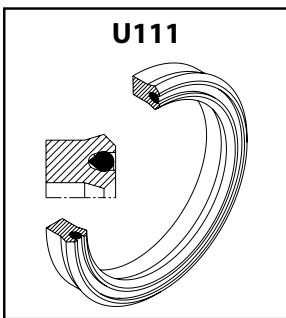
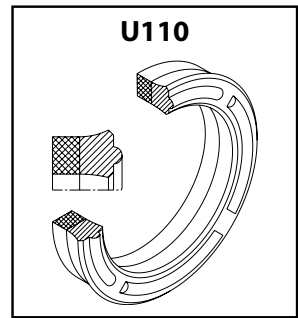
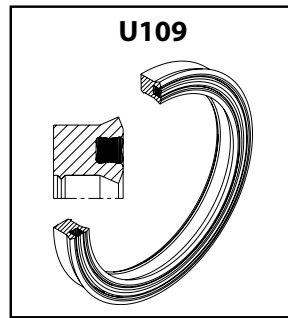
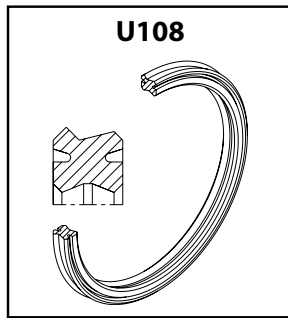
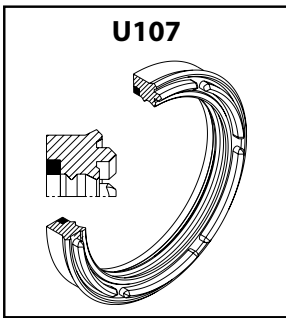
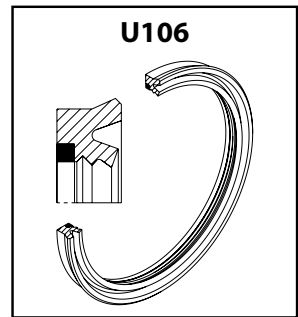
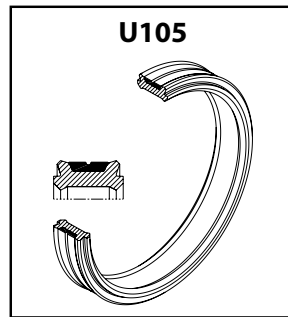
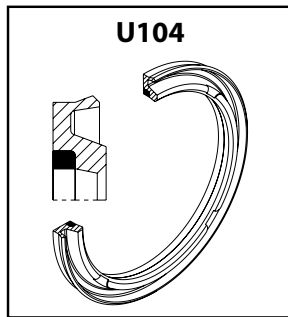
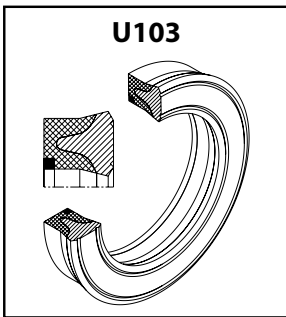
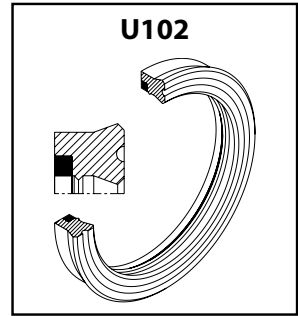
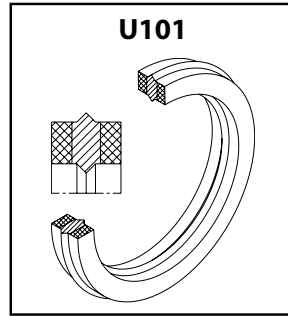
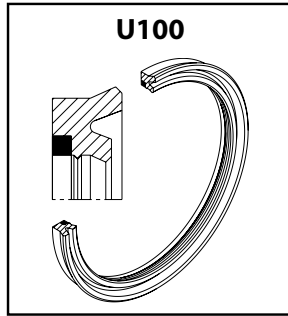
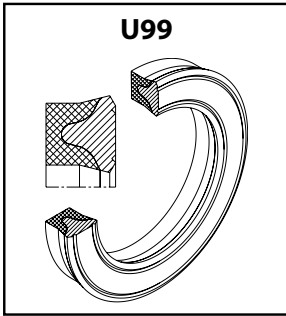



TECHNICAL DETAIL: LIP SEAL

TYPES

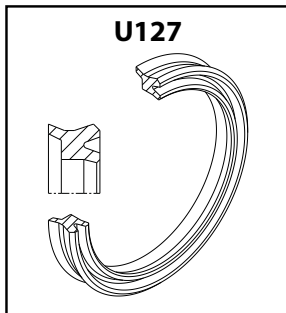
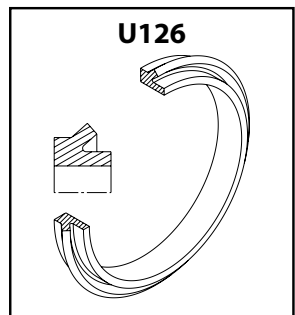
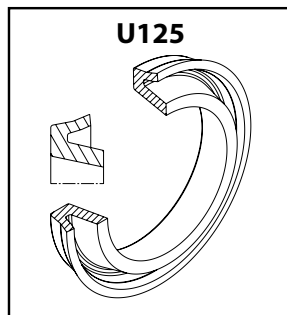
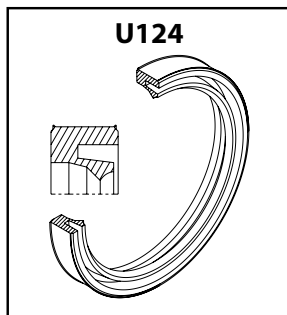
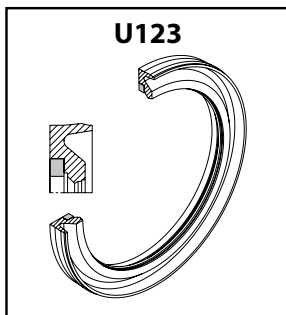
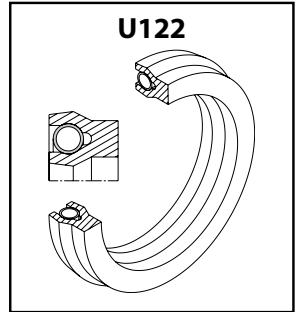
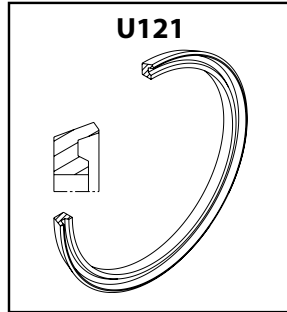
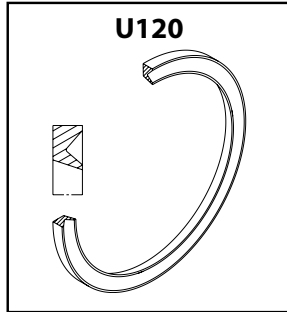
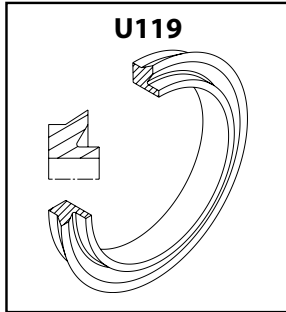



TECHNICAL DETAIL: LIP SEAL

Groep
03-03-01-00

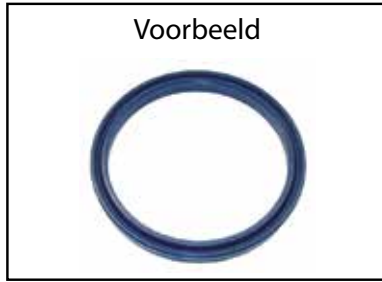

Gegevens klant

Type machine:
 Serienr. machine:

Prijsaanvraag
 Bestelling

CODE: TY-LS x MI x D1 x D2 x H2 x D3 x D4 x H4 x MAT



- TY-LS..... Type van de dichting:
(U1, U2, U3, ...) (zie tekeningen)
- MI..... Eenheid:
M = metrisch
I = imperial (niet-metrisch)
- D1 Binnendiameter van de dichting (mm).
- D2 Buitendiameter van de dichting (mm).
- H2 Hoogte van de dichting (mm).
- D3 Binnendiameter van de dichting (duim).
- D4 Buitendiameter van de dichting (duim).
- H4 Hoogte van de dichting (duim).
- MAT..... Materiaal van de dichting:
PU = polyurethaan (blauw, groen, rood, geel)
NBR = rubber (zwart)
PTFE = polytetrafluoretheen (wit, niet doorzichtig)
FPM = fluorcarbon rubber (mat zwart, bruin)
PUNY = polyurethaan + nylon
PUPTFE = polyurethaan + polytetrafluoretheen
NBRNY = rubber + nylon
FPMNY = fluorcarbon rubber + nylon
NBRPTFE = rubber + polytetrafluoretheen
FPMPB = fluorocarbon rubber + polytetrafluoretheen met brons

zie Engelse technische fiche !



TECHNICAL DETAIL: LIP SEAL

Groupe
03-03-01-00

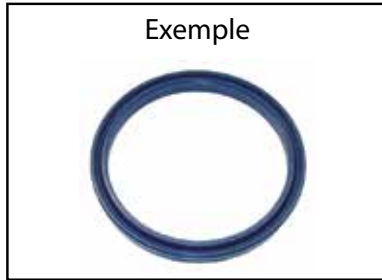

Données client

Type machine :

Demande de prix

No. série machine :

Commande

CODE : TY-LS x MI x D1 x D2 x H2 x D3 x D4 x H4 x MAT



- TY-LS..... Type de joint :
(U1, U2, U3, ...) (voir les dessins)
- MI..... Unité :
M = métrique
I = impérial (pas métrique)
- D1 Diamètre intérieur du joint (mm).
- D2 Diamètre extérieur du joint (mm).
- H2 Hauteur du joint (mm).
- D3 Diamètre intérieur du joint (pouce).
- D4 Diamètre extérieur du joint (pouce).
- H4 Hauteur du joint (pouce).
- MAT..... Matériel du joint :
PU = polyuréthane (bleu, vert, rouge, jaune)
NBR = caoutchouc (noir)
PTFE = polytétrafluoréthylène (blanc, opaque)
FPM = fluorocarbone caoutchouc (noir mat, brun)
PUNY = polyuréthane + nylon
PUPTFE = polyuréthane + polytétrafluoréthylène
NBRNY = caoutchouc + nylon
FPMNY = fluorocarbone caoutchouc + nylon
NBRPTFE = caoutchouc + polytétrafluoréthylène
FPMPB = fluorocarbone caoutchouc + polytétrafluoréthylène avec bronze

voir la fiche technique en Anglais.



TECHNICAL DETAIL: LIP SEAL

Gruppe
03-03-01-00



Kundendaten

Maschinentyp:

Preis Anfrage

Serien-Nr. Maschine:

Bestellung

CODE: TY-LS x MI x D1 x D2 x H2 x D3 x D4 x H4 x MAT



- TY-LS..... Art der Abdichtung:
(U1, U2, U3, ...) (Siehe Zeichnung)
- MI..... Einheit:
M = Metrisch
I = Imperial (keine metrischen)
- D1 Innerdurchmesser der Dichtung (mm).
- D2 Außendurchmesser der Dichtung (mm).
- H2 Höhe der Dichtung (mm).
- D3 Innerdurchmesser der Dichtung (inch).
- D4 Außendurchmesser der Dichtung (inch).
- H4 Höhe der Dichtung (inch).
- MAT..... Material der Dichtung:
PU = Polyetherethan (blau, grün, rot, gelb)
NBR = Gummi (schwarz)
PTFE = Teflon (weiße, opake)
FPM = Fluorcarbone gummi (mattschwarz, braun)
PUNY = Polyurethan + Nylon
PUPTFE = Polyurethan + Teflon
NBRNY = Gummi + Nylon
FPMNY = Fluorcarbone gummi + Nylon
NBRPTFE = Gummi + Teflon
FPMPB = Fluorkarbon Gummi + Polytetrafluorethylen mit Bronze

Siehe technische Datenblätter auf Englisch.



WIPER RING

WIPER RING

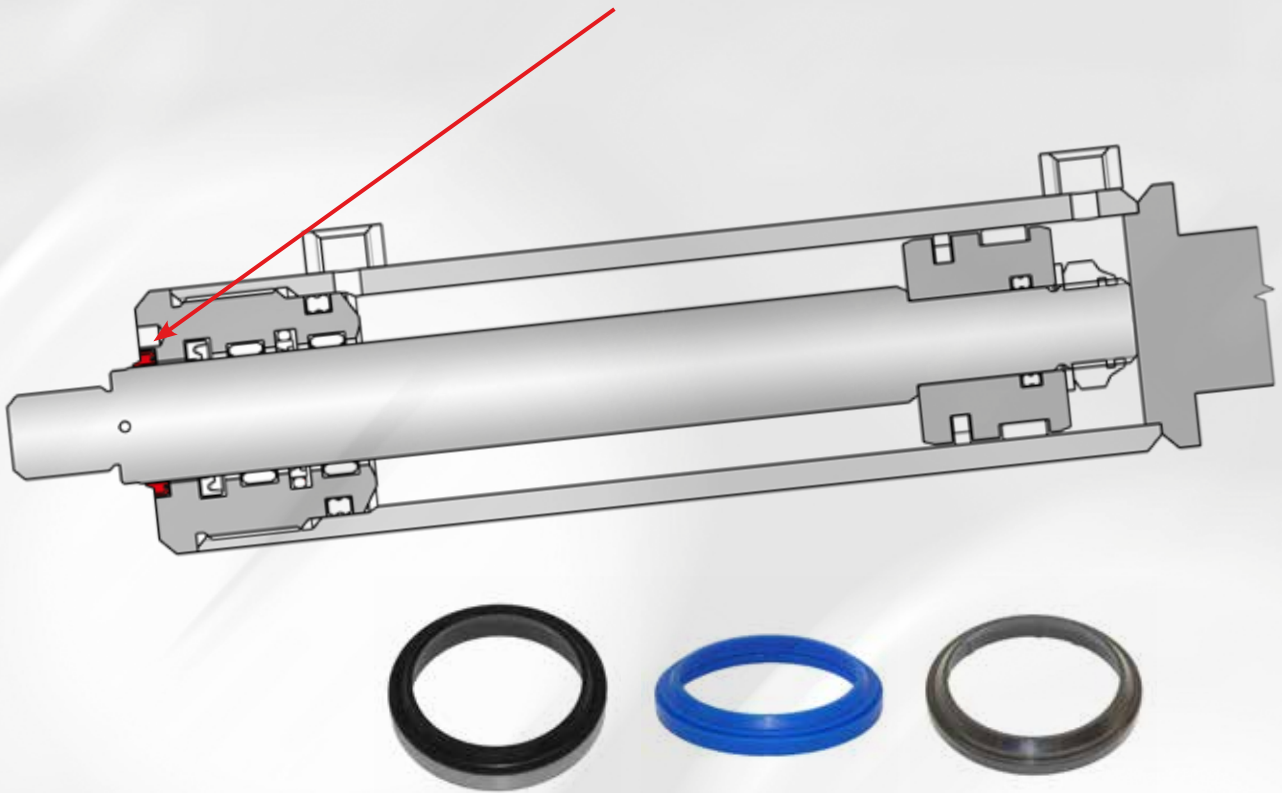

WIPER RING

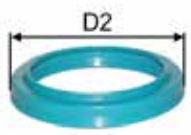

[Reset](#)

Refine search

Outer diameter D2 (mm):

[Next](#) [Tolerances](#)

Search results

TVHNumber	TY-GR	TY-WR	D1	D2	H1	MAT
414955	€ ⓘ CLOSED GROOVE	R63	60	73	7	Polyamide (= nylon) (white)
12493591	€ ⓘ CLOSED GROOVE	R52	60	69.6	5.3	Polyurethane (bleu, green, yellow)
18753950	€ ⓘ CLOSED GROOVE	R04	60	73	7	Polyurethane (bleu, green, yellow)
11087484	€ ⓘ CLOSED GROOVE	R37	60	70.6	5.3	Polyurethane (bleu, green, yellow)
17308073	€ ⓘ CLOSED GROOVE	R04	60	70	5.4	Polyurethane (bleu, green, yellow)
14495780	€ ⓘ CLOSED GROOVE	R04	60	73	7	Polyurethane (bleu, green, yellow)
14789404	€ ⓘ CLOSED GROOVE	R37	60	70.6	5.3	Polyurethane (bleu, green, yellow)
5885190	€ ⓘ CLOSED GROOVE	R37	60	70.6	5.5	Polyurethane (bleu, green, yellow)
10431958	€ ⓘ CLOSED GROOVE	R68	60	71	6	Polyurethane (bleu, green, yellow)
3688614	€ ⓘ CLOSED GROOVE	R03	60	68	4	Polyurethane (bleu, green, yellow)

MyProductSearch: Use technical details or specifications to find your necessary parts.
 No part number, no brand, no type of truck?
 Identify your parts by means of specifications or technical info.





TECHNICAL DETAIL: WIPER RING

Group
03-03-03-00

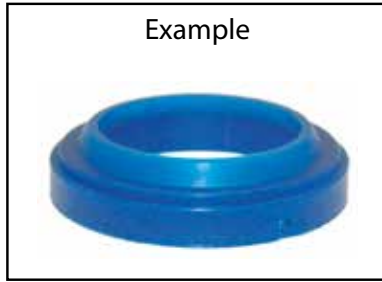

Customer details

Type machine:
Serial n° machine:

Price inquiry
Order

CODE: TY-GR x TY-WR x MI x D1 x D2 x H1 x H2 x H3 x RBS x MAT x D5 x D6 x H4 x H5 x H6



- TY-GR Type of the groove:
C = closed
O = open
- TY-WR Type of the wiper ring (see drawings).
- MI Unit of measurement:
M = metric
I = imperial (non-metric)
- D1 Inner diameter of the wiper ring (mm).
- D2 Outer diameter of the wiper ring (mm).
- H1 Working height of the wiper ring (mm).
- H2 Total height of the wiper ring (mm).
- H3 Mounting height according type (mm).
- RBS Waves or ribs: YES/NO.



TECHNICAL DETAIL: WIPER RING

- MAT..... Material of the wiper ring:
PU = polyurethane (bleu, green, yellow)
NBR = rubber (black)
POL = polyester (red)
PA = polyamide (= nylon) (white)
FPM = fluo-carbon rubber (matted black)
POM = acetal (white/black)
NBR/ST = rubber with metal outer ring
PU/ST = polyurethane with metal outer ring
NBR/ST+PA = rubber with metal outer ring and nylon inner ring
PTFE/NBR = polytetrafluoroethene + rubber
PB/NBR = polytetrafluoroethene with brass + rubber
PU/NBR = polyurethane + rubber
TURCON/NBR = special polytetrafluoroethene (greenish blue coloured) + rubber
- D5 Inner diameter of the wiper ring (inch).
D6 Outer diameter of the wiper ring (inch).
H4 Working height of the wiper ring (inch).
H5 Total height of the wiper ring (inch).
H6 Mounting height according type (inch).



TECHNICAL DETAIL: WIPER RING

TYPE OF THE GROOVE

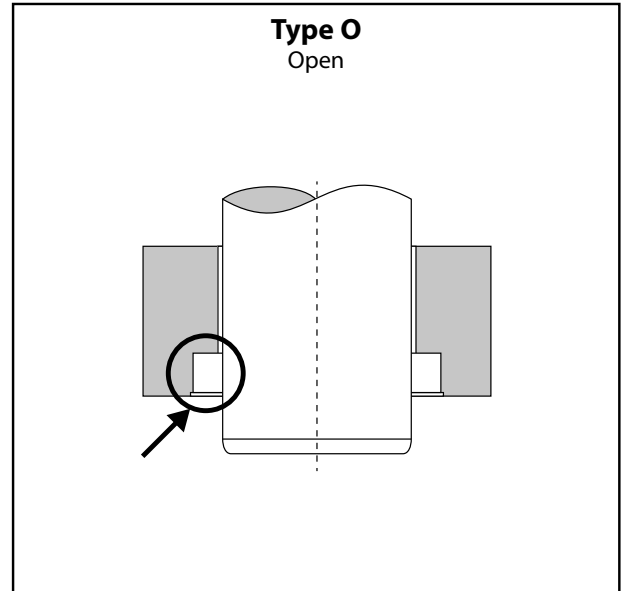
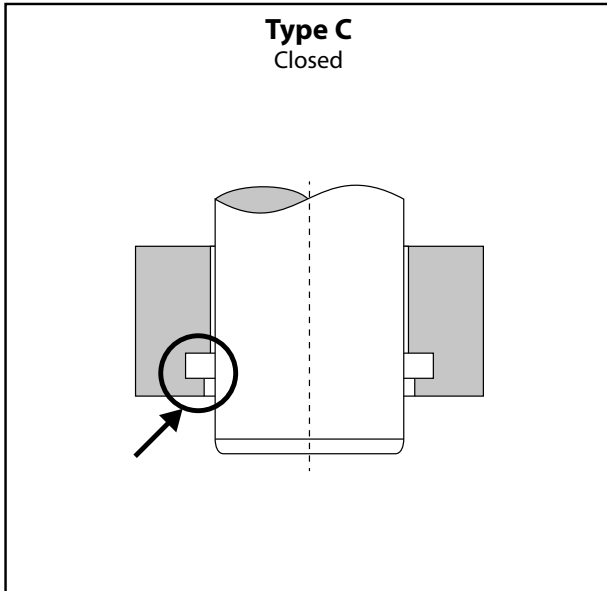

DIMENSIONS

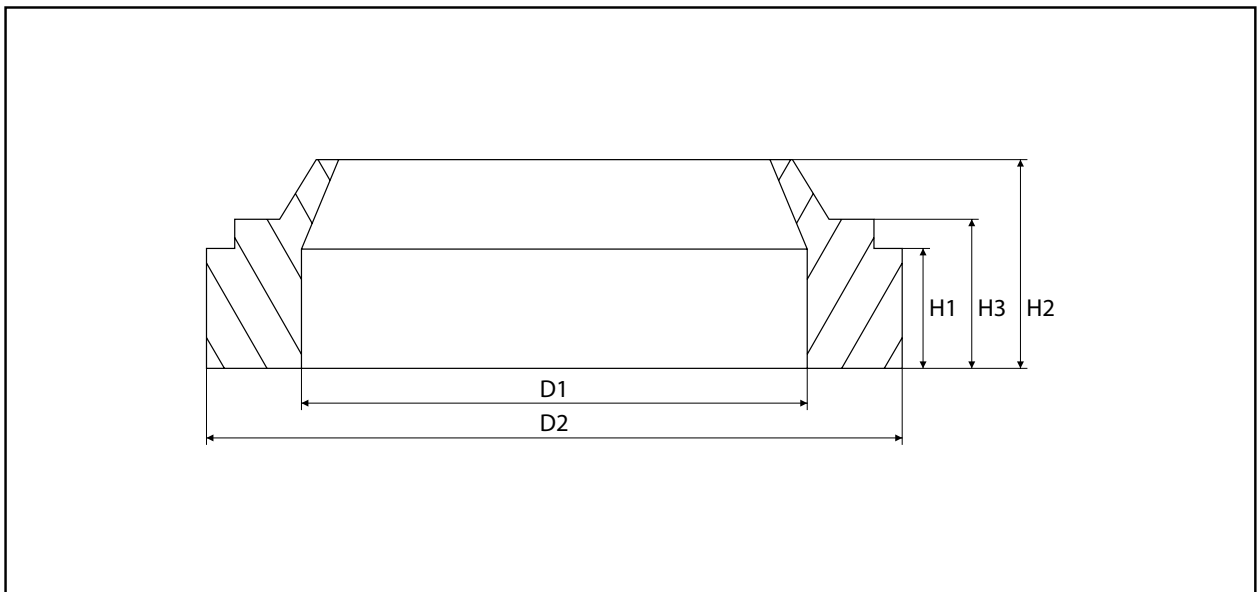



TECHNICAL DETAIL: WIPER RING

TYPES

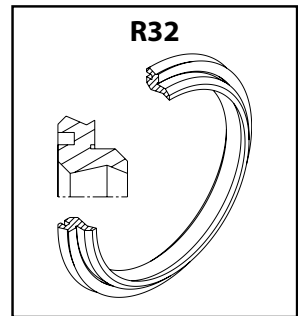
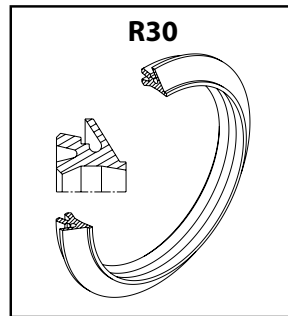
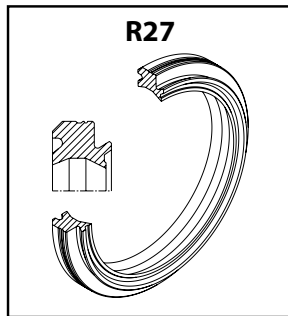
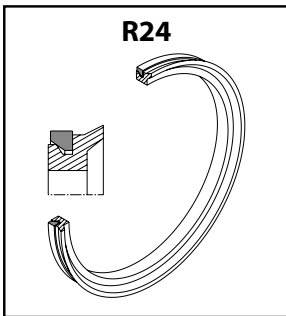
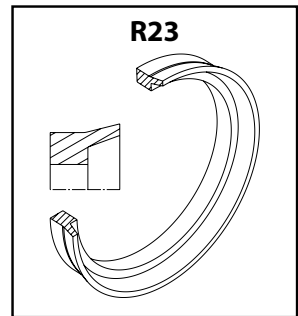
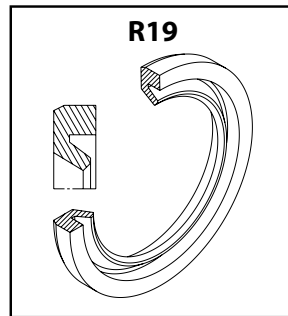
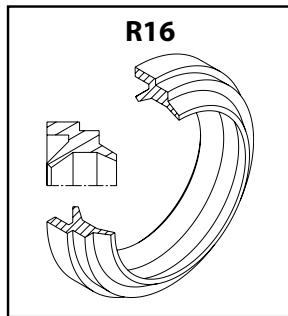
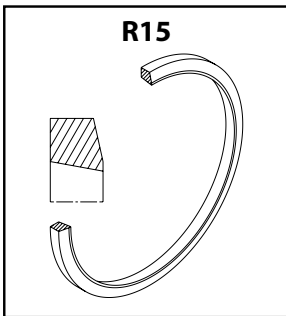
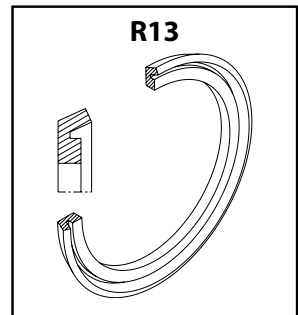
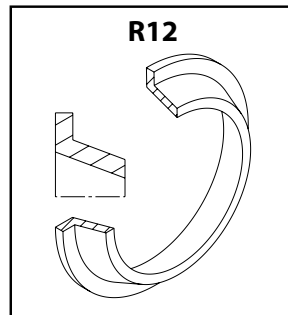
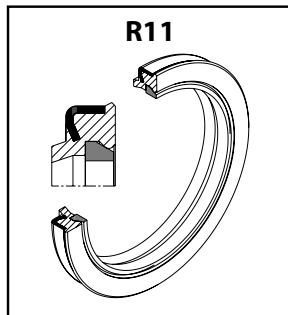
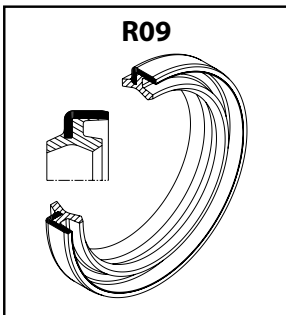
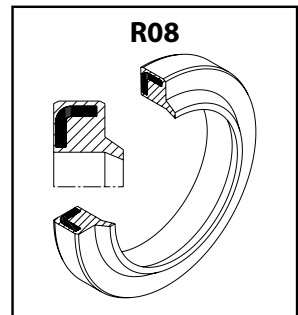
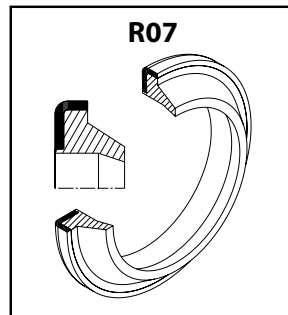
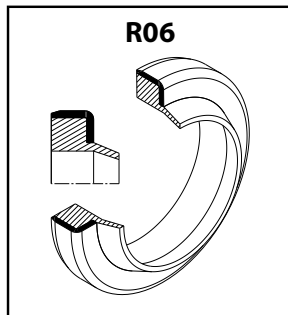
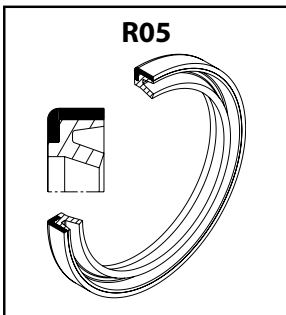
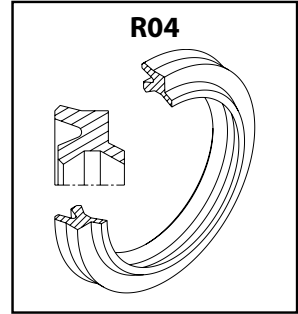
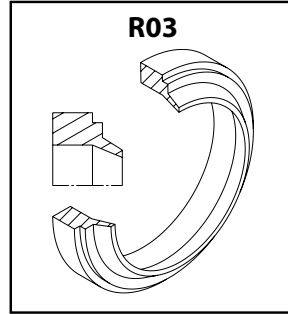
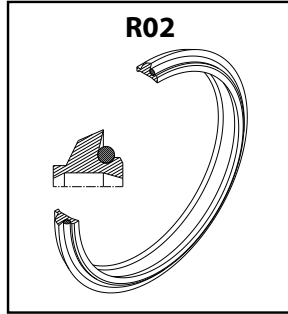
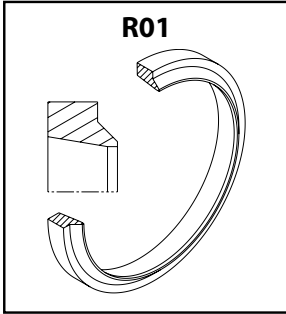



TECHNICAL DETAIL: WIPER RING

TYPES

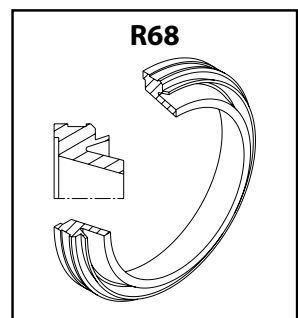
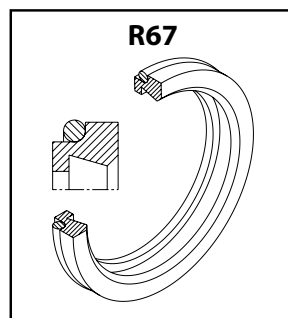
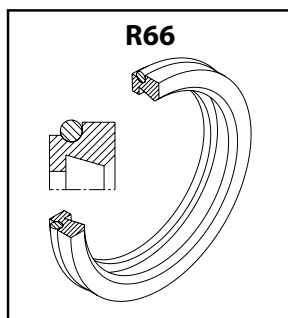
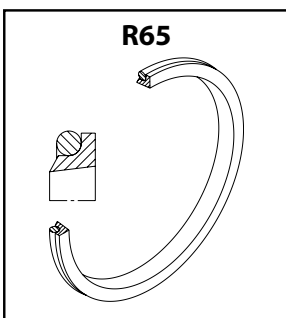
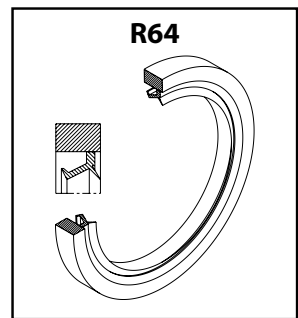
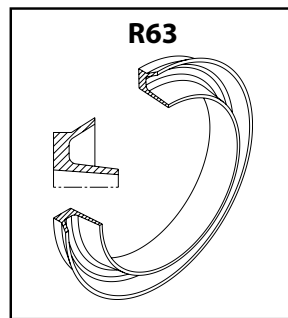
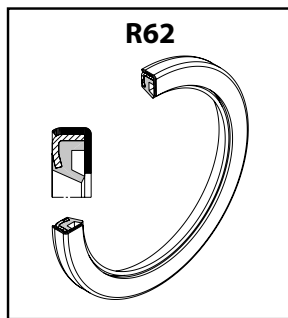
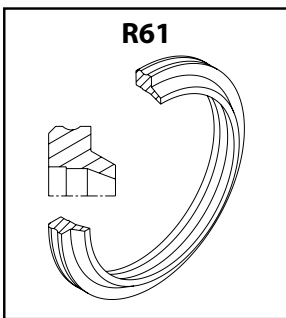
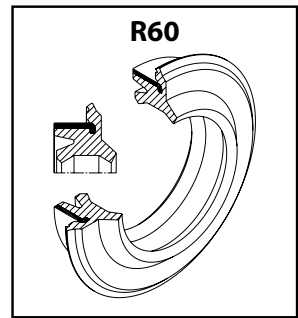
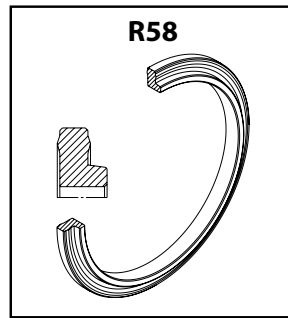
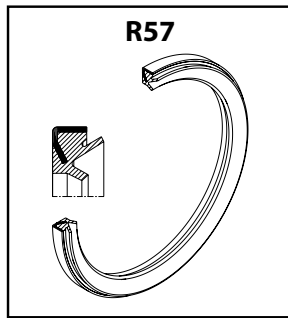
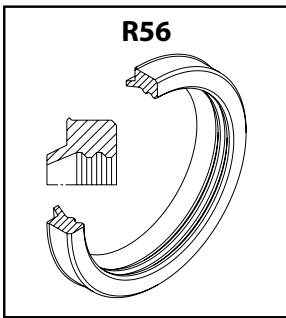
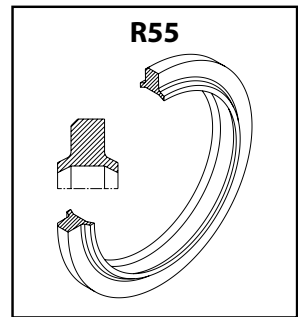
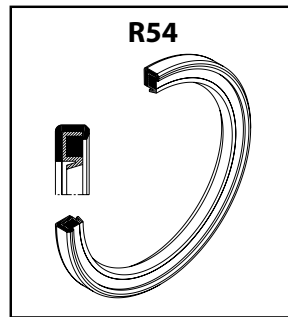
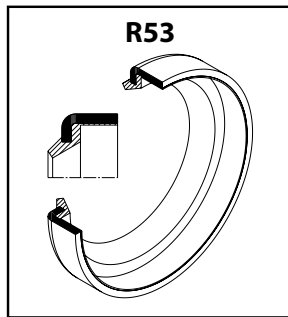
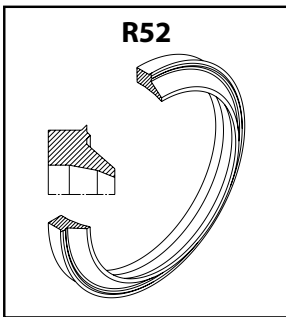
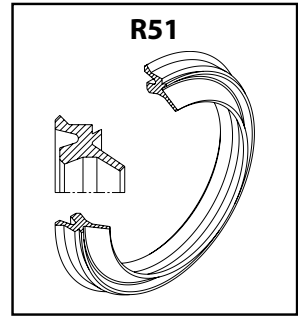
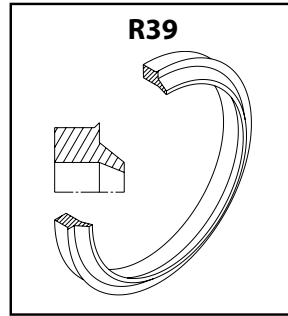
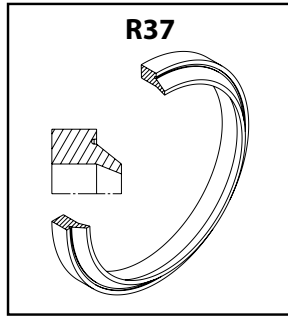
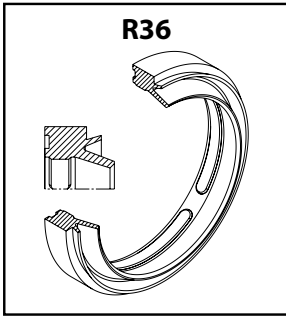



TECHNICAL DETAIL: WIPER RING

TYPES

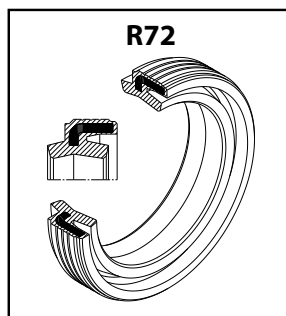
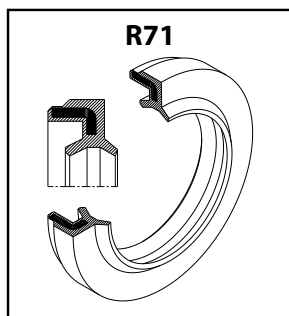
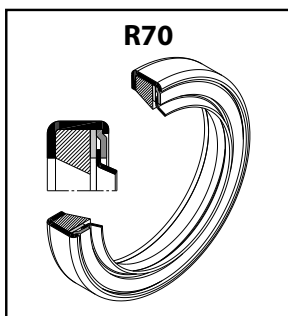



TECHNICAL DETAIL: WIPER RING

Groep
03-03-03-00



Gegevens klant

Type machine:

Prijsaanvraag

Serienr. machine:

Bestelling

CODE: TY-GR x TY-WR x MI x D1 x D2 x H1 x H2 x H3 x RBS x MAT x D5 x D6 x H4 x H5 x H6

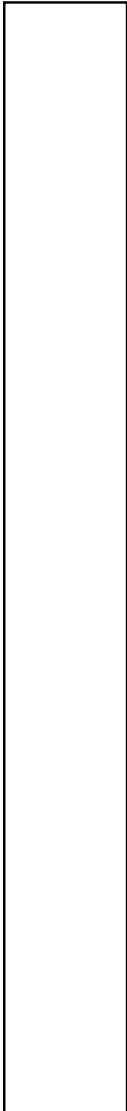

TY-GR Type van de groef:

C = gesloten

O = open

TY-WR Type van de stofring (zie tekeningen).

MI Eenheid:

M = metrisch

I = imperial (niet-metrisch)

D1 Binnendiameter van de stofring (mm).

D2 Buitendiameter van de stofring (mm).

H1 Werkhoogte van de stofring (mm).

H2 Totale hoogte van de stofring (mm).

H3 Inbouwhoogte volgens type (mm).

RBS Golven of ribben: JA/NEE.

zie Engelse technische fiche !



TECHNICAL DETAIL: WIPER RING

MAT..... Materiaal:

PU = polyurethaan (blauw, groen, geel)

NBR = rubber (zwart)

POL = polyester (rood)

PA = polyamide (= nylon) (wit)

FPM = fluocarbon rubber (mat zwart)

POM = acetaalhars (wit/zwart)

NBR/ST = rubber met metalen buitenring

PU/ST = polyurethaan met metalen buitenring

NBR/ST+PA = rubber met metalen buitenring en nylon binnenring

PTFE/NBR = polytetrafluoretheen + rubber

PB/NBR = polytetrafluoretheen met brons + rubber

PU/NBR = polyurethaan + rubber

TURCON/NBR = speciaal polytetrafluoretheen (blauwgroene kleur) + rubber

D5 Binnendiameter van de stofring (duim).

D6 Buitendiameter van de stofring (duim).

H4 Werkhoogte van de stofring (duim).

H5 Totale hoogte van de stofring (duim).

H6 Inbouwhoogte volgens type (duim).

zie Engelse technische fiche !



TECHNICAL DETAIL: WIPER RING

Groupe
03-03-03-00

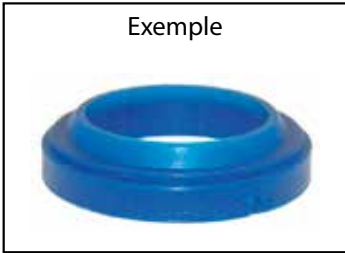

Données client

Type machine : Demande de prix
 No. série machine : Commande

CODE : TY-GR x TY-WR x MI x D1 x D2 x H1 x H2 x H3 x RBS x MAT x D5 x D6 x H4 x H5 x H6



- TY-GR Type de la rainure :
 C = fermé
 O = ouvert
- TY-WR Type du racleur (voir les dessins).
- MI Unité :
 M = métrique
 I = impérial (pas métrique)
- D1 Diamètre intérieur du racleur (mm).
- D2 Diamètre extérieur du racleur (mm).
- H1 Hauteur de travail du racleur (mm).
- H2 Hauteur totale du racleur (mm).
- H3 Hauteur de la structure selon type (mm).
- RBS Ondulations ou rides : OUI/NON.

voir la fiche technique en Anglais.



TECHNICAL DETAIL: WIPER RING

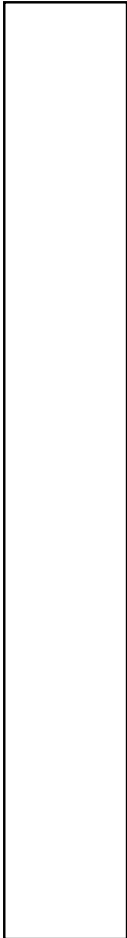

MAT..... Matériel :

PU = polyuréthane (blue, vert, jaune)

NBR = caoutchouc (noir)

POL = polyester (rouge)

PA = polyamide (= nylon) (blanc)

FPM = fluocarbon caoutchouc (noir mat)

POM = résine acétale (blanc/noir)

NBR/ST = caoutchouc avec bague métallique extérieure

PU/ST = polyuréthane avec bague métallique extérieure

NBR/ST+PA = caoutchouc avec bague métallique extérieure et bague intérieure en nylon

PTFE/NBR = polytétrafluoroéthylène + caoutchouc

PB/NBR = polytétrafluoroéthylène avec bronze + caoutchouc

PU/NBR = polyuréthane + caoutchouc

TURCON/NBR = polytétrafluoroéthylène spécial (couleur bleu-vert) + caoutchouc

D5 Diamètre intérieur du racleur (pouce).

D6 Diamètre extérieur du racleur (pouce).

H4 Hauteur de travail du racleur (pouce).

H5 Hauteur totale du racleur (pouce).

H6 Hauteur de la structure selon type (pouce).

voir la fiche technique en Anglais.



TECHNICAL DETAIL: WIPER RING

Gruppe
03-03-03-00



Kundendaten

Maschinentyp:

Preis Anfrage

Serien-Nr. Maschine:

Bestellung

CODE: TY-GR x TY-WR x MI x D1 x D2 x H1 x H2 x H3 x RBS x MAT x D5 x D6 x H4 x H5 x H6



TY-GR Art der Nut:

C = closed

O = open

TY-WR Typ Abstreifer (siehe Zeichnung).

MI Maßeinheit:

M = metrisch

I = imperial (nicht metrisch)

D1 Innendurchmesser des Abstreifers (mm).

D2 Außendurchmesser des Abstreifers (mm).

H1 Nutzfläche des Abstreifers (mm).

H2 Gesamthöhe des Abstreifers (mm).

H3 Einbauhöhe nach Typ (mm).

RBS Wellen oder Rippen: JA/NEIN.

Siehe technische Datenblätter auf Englisch.



TECHNICAL DETAIL: WIPER RING

MAT..... Material:

PU = Polyurethan (blau, grün, gelb)

NBR = Gummi (schwarz)

POL = Polyester (rot)

PA = Polyamid (= Nylon) (weiß)

FPM = Fluo Kautschuk (mattschwarz)

POM = Acetal (weiß/schwarz)

NBR/ST = Gummi mit Metall Außenring

PU/ST = Polyurethan mit Metall Außenring

NBR/ST+PA = Gummi mit Metall Außenring und Nylon Innenring

PTFE/NBR = Teflon + Gummi

PB/NBR = Teflon mit Bronze + Gummi

PU/NBR = Polyurethan + Gummi

TURCON/NBR = Spezial teflon (blau-grüne Farbe) + Gummi

D5 Innendurchmesser des Abstreifers (Zoll).

D6 Außendurchmesser des Abstreifers (Zoll).

H4 Nutzfläche des Abstreifers (Zoll).

H5 Gesamthöhe des Abstreifers (Zoll).

H6 Einbauhöhe nach Typ (Zoll).

Siehe technische Datenblätter auf Englisch.



COMPOSITE SEAL

COMPOSITE SEAL

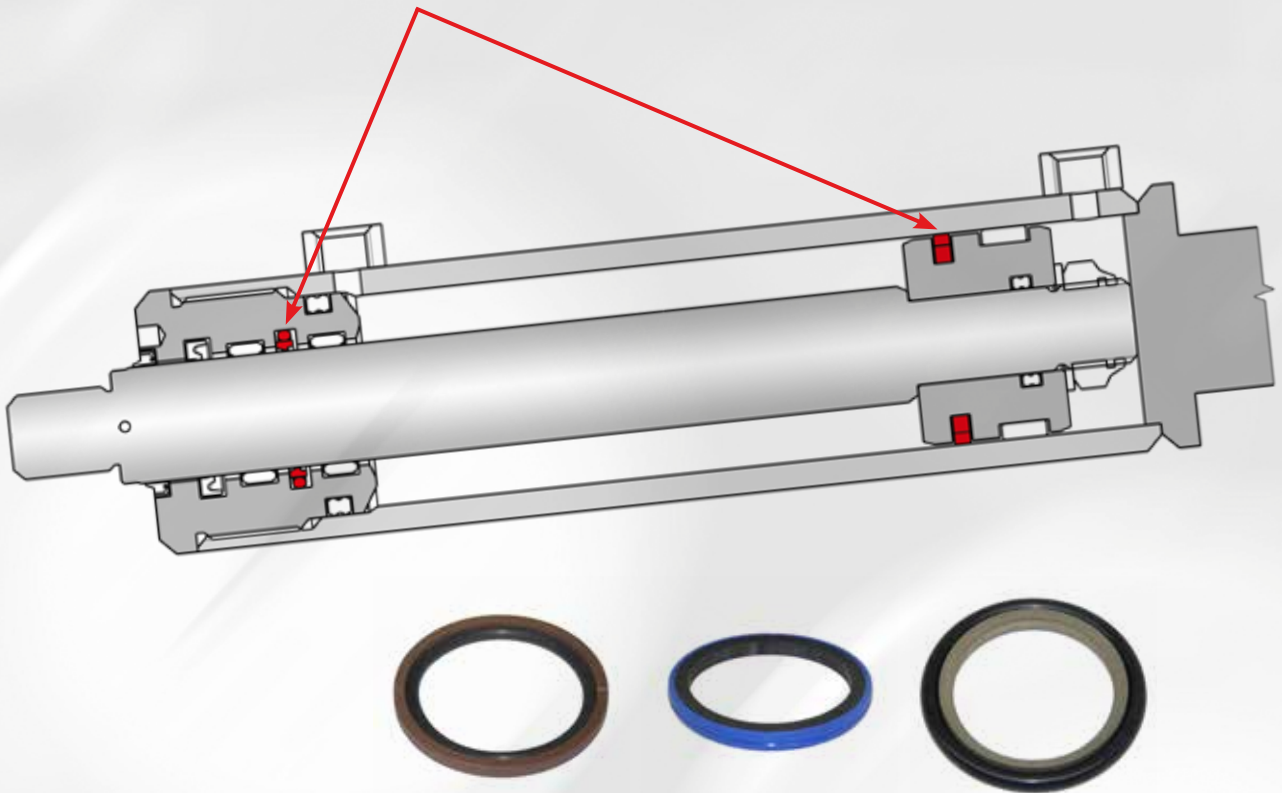

COMPOSITE SEAL

Refine search

Outer diameter of the seal D2 (mm)

next Tolerances

Search results

TVHNumber	D1	D2	H2	TY-C5	TY-ORK	POS-ORK	TY-RING	MAT
11767909	30	41.5	4	C01	Round	Outside	Closed	Polytetrafluoroethene with brass + rubber
1120992	30	37.3	3.2	C01	Round	Outside	Closed	Polytetrafluoroethene + rubber

MyProductSearch: Use technical details or specifications to find your necessary parts.
 No part number, no brand, no type of truck?
 Identify your parts by means of specifications or technical info.





TECHNICAL DETAIL: COMPOSITE SEAL

Group
03-03-16-00

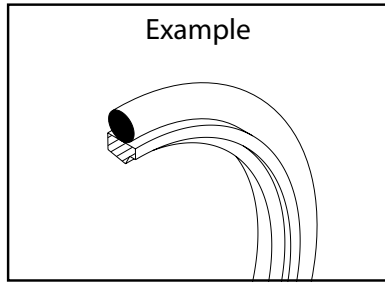

Customer details

Type machine:
Serial n° machine:

Price inquiry
Order

CODE: D1 x D2 x H2 x TY-CS x TY-ORK x POS-ORK x TY-RING x MAT

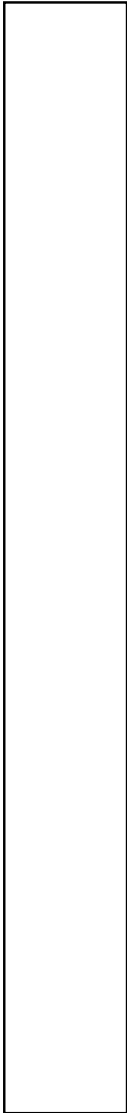

- D1 Inner diameter of the seal (mm).
- D2 Outer diameter of the seal (mm).
- H2 Height of the seal (mm).
- TY-CS Type of the composite seal (see drawings).
- TY-ORK..... Type of the O-ring:
 - R = round*
 - S = square*
 - Q = cruciform*
- POS-ORK Position of the O-ring:
 - I = inside*
 - O = outside*
- TY-RING Type of the dynamic ring:
 - O = open*
 - C = closed*
- MAT..... Material of the seal:
 - PTFE NBR = polytetrafluoroethene + rubber*
 - PB NBR = polytetrafluoroethene with brass + rubber*
 - PU NBR = polyurethane + rubber*
 - TURCON NBR = special polytetrafluoroethene (greenish blue coloured) + rubber*
 - Other combinations possible: VIT = viton instead of NBR*



TECHNICAL DETAIL: COMPOSITE SEAL

DIMENSIONS

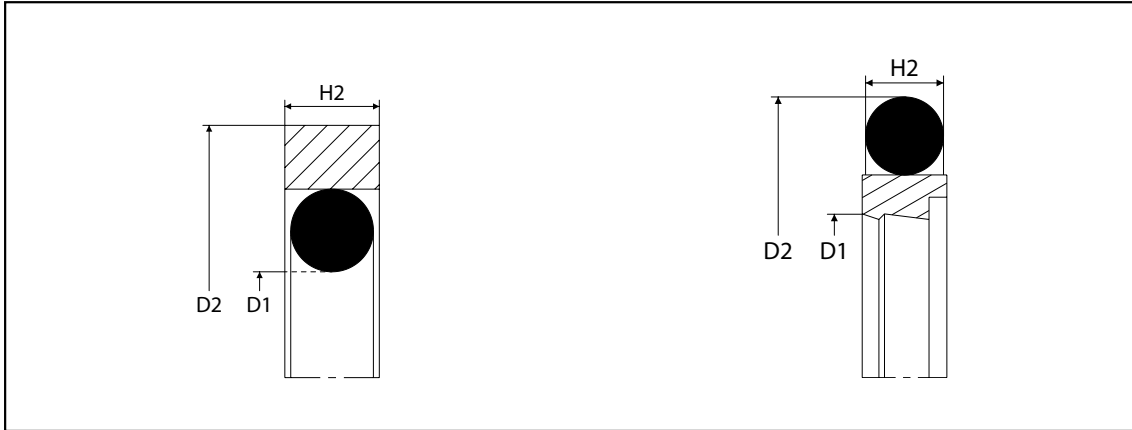

TY-ORK: TYPE OF THE O-RING

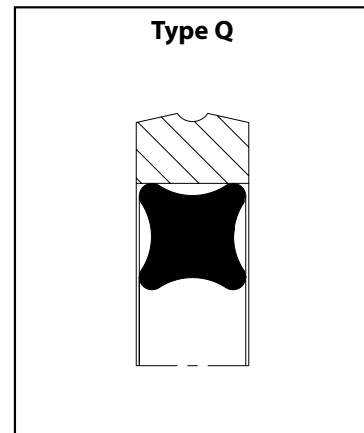
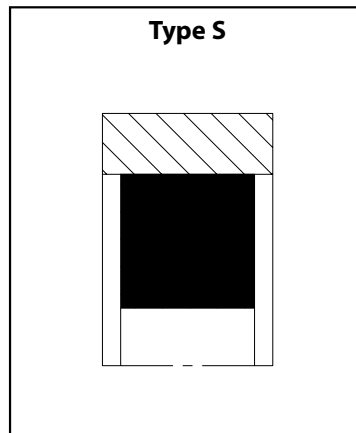
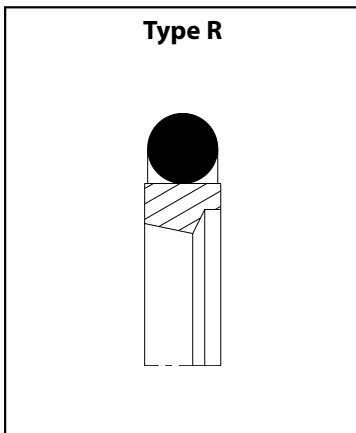

POS-ORK: POSITION OF THE O-RING

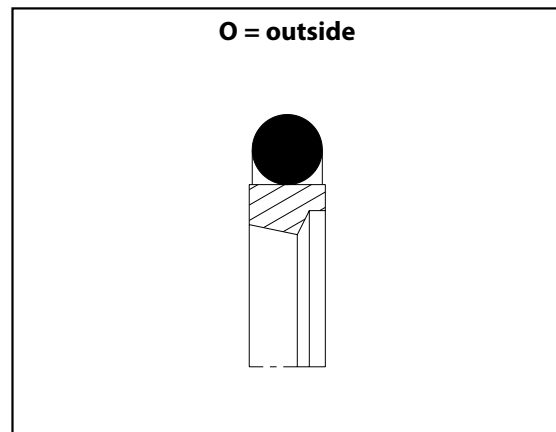
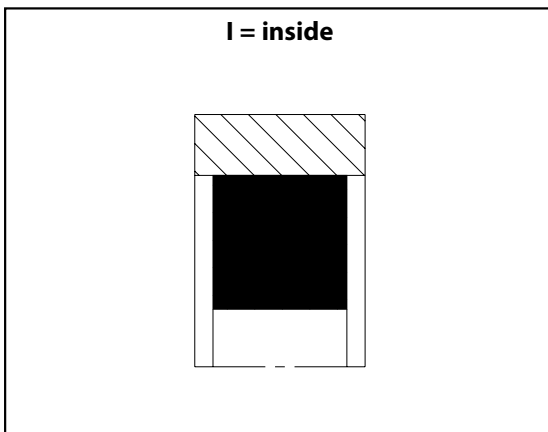



TECHNICAL DETAIL: COMPOSITE SEAL

TY-CS: TYPES

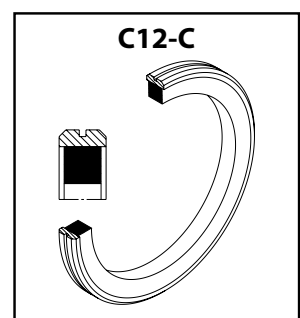
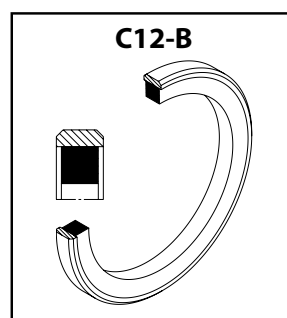
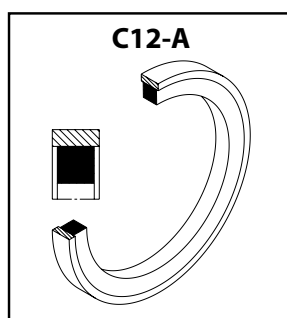
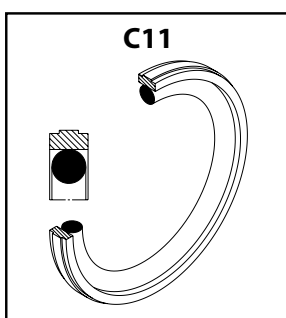
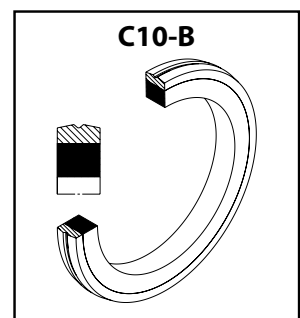
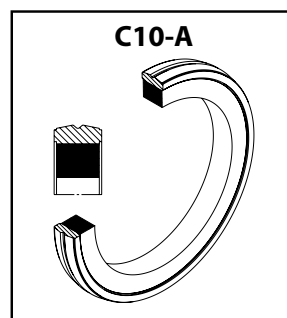
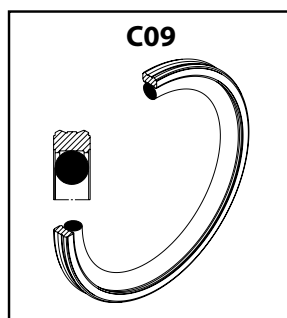
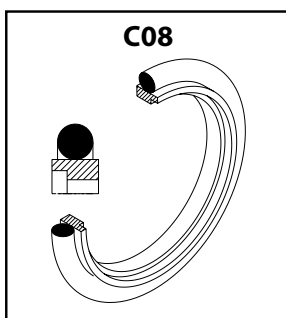
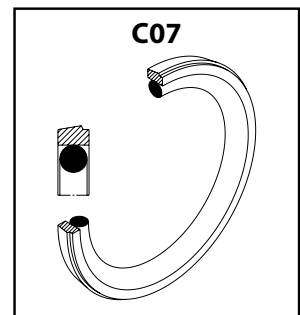
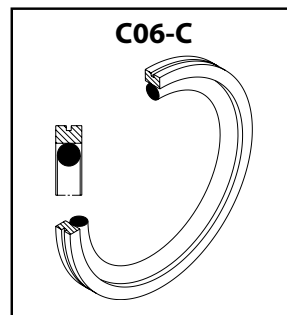
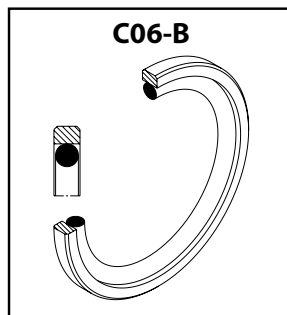
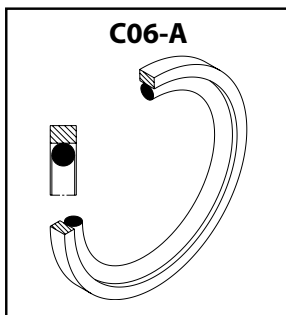
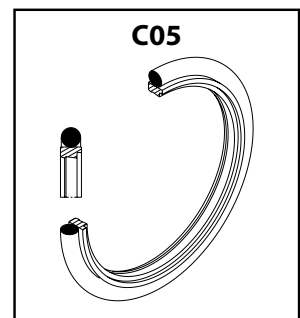
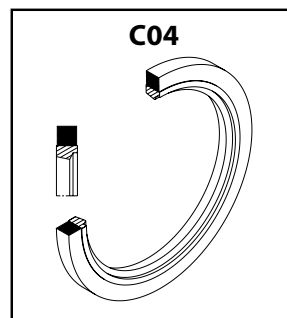
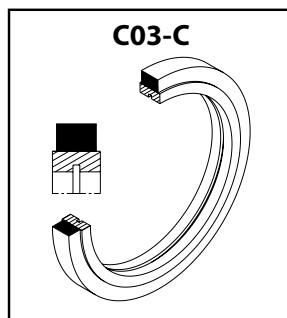
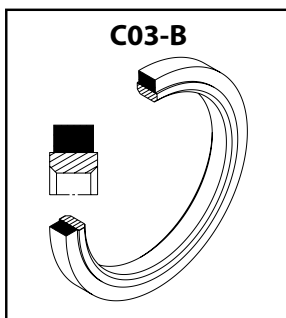
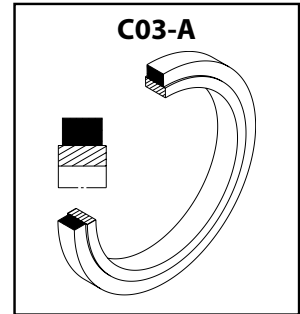
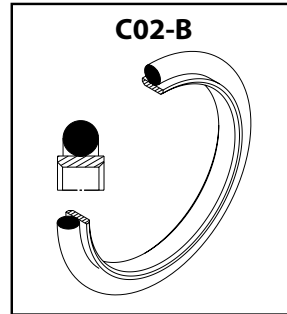
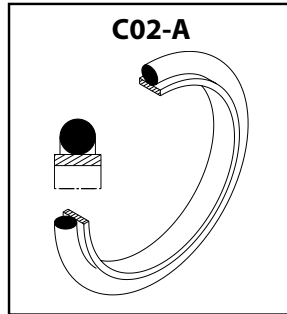
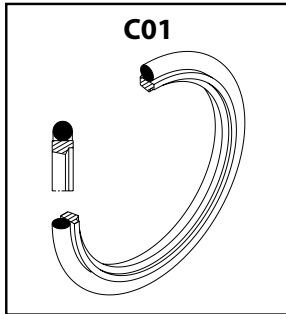



TECHNICAL DETAIL: COMPOSITE SEAL

TY-CS: TYPES

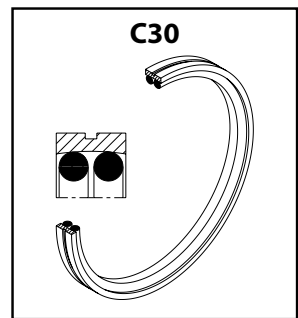
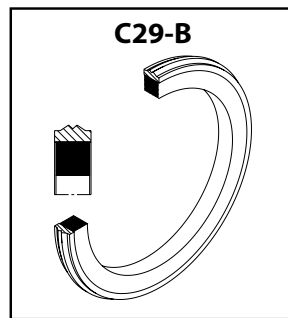
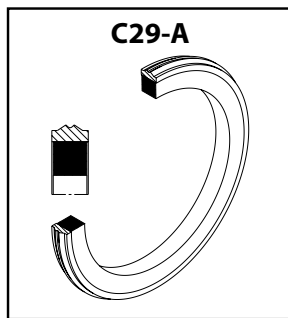
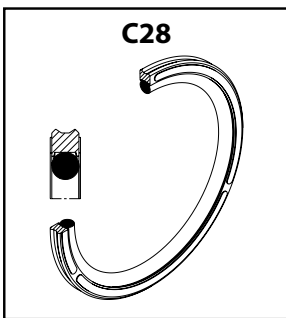
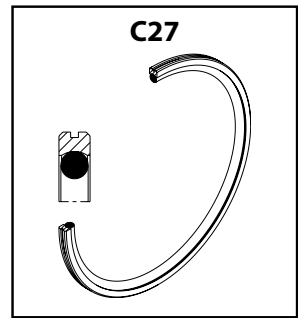
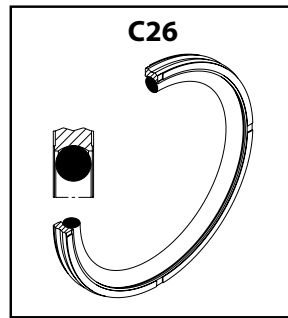
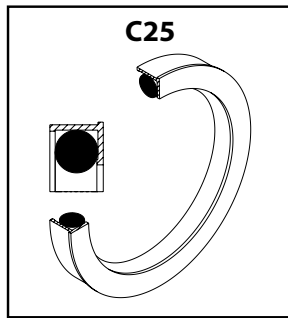
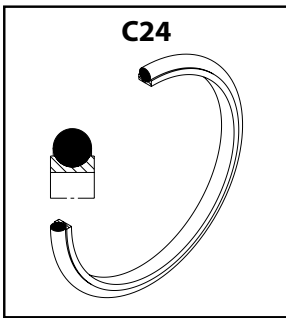
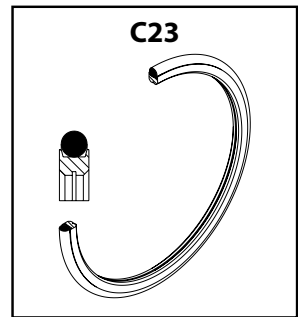
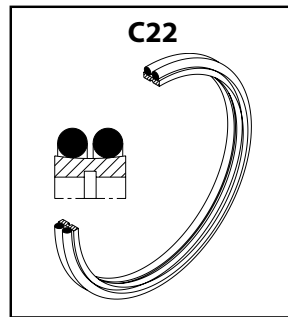
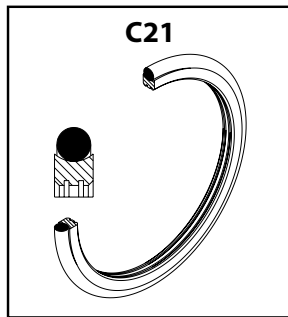
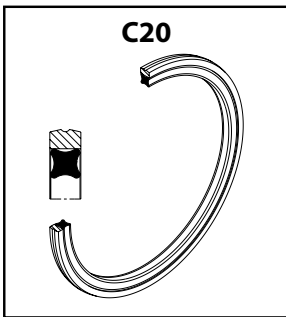
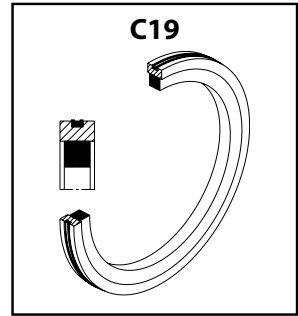
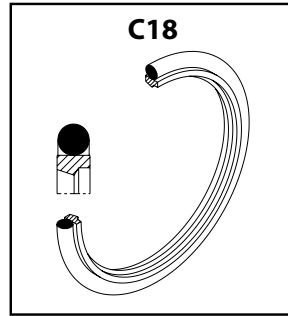
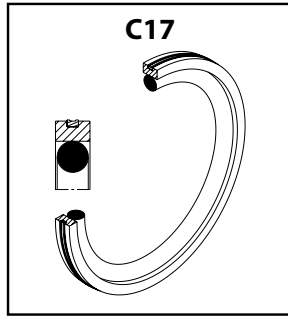
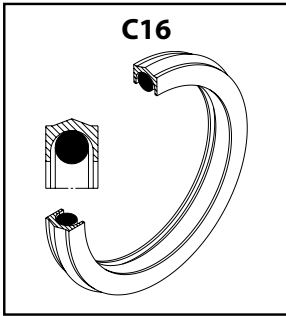



TECHNICAL DETAIL: COMPOSITE SEAL

Groep
03-03-16-00

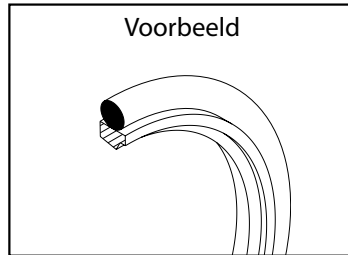

Gegevens klant

Type machine:
Serienr. machine:

Prijsaanvraag
Bestelling

CODE: D1 x D2 x H2 x TY-CS x TY-ORK x POS-ORK x TY-RING x MAT

- D1 Binnendiameter van de dichting (mm).
- D2 Buitendiameter van de dichting (mm).
- H2 Hoogte van de dichting (mm).
- TY-CS Type van de composiet dichting (zie tekeningen).
- TY-ORK Type van de O-ring:
 - R = rond
 - S = vierkant
 - Q = kruisvorm
- POS-ORK Positie van de O-ring:
 - I = binnen
 - O = buiten
- TY-RING Type van de dynamische dichting:
 - O = open
 - C = gesloten
- MAT Materiaal van de dichting:
 - PTFE NBR = polytetrafluoretheen + rubber
 - PB NBR = polytetrafluoretheen met brons + rubber
 - PU NBR = polyurethaan + rubber
 - TURCON NBR = speciaal polytetrafluoretheen (blauwgroene kleur) + rubber
 - Andere combinaties mogelijk: VIT = viton ipv NBR

zie Engelse technische fiche !



TECHNICAL DETAIL: COMPOSITE SEAL

Groupe
03-03-16-00

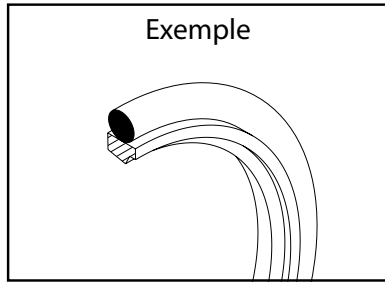

Données client

Type machine :

Demande de prix

No. série machine :

Commande

CODE : D1 x D2 x H2 x TY-CS x TY-ORK x POS-ORK x TY-RING x MAT

D1 Diamètre intérieur du joint (mm).

D2 Diamètre extérieur du joint (mm).

H2 Hauteur du joint (mm).

TY-CS Type de joint (voir les dessins).

TY-ORK..... Type de joint torique :

R = rond

S = carré

Q = cruciforme

POS-ORK..... Position du joint torique :

I = à l'intérieur

O = à l'extérieur

TY-RING..... Type de joint dynamique :

O = ouvert

C = fermé

MAT..... Matériel du joint:

PTFE NBR = polytétrafluoroéthylène + caoutchouc

PB NBR = polytétrafluoroéthylène avec bronze + caoutchouc

PU NBR = polyuréthane + caoutchouc

TURCON NBR = polytétrafluoroéthylène spécial (couleur bleu-vert) + caoutchouc

Autres combinaisons possibles : VIT = viton au lieu de NBR

voir la fiche technique en Anglais.



TECHNICAL DETAIL: COMPOSITE SEAL

Gruppe
03-03-16-00

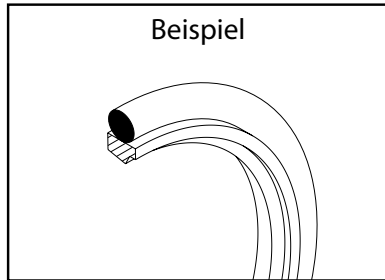

Kundendaten

Maschinentyp:

Preis-anfrage

Serien-Nr. Maschine:

Bestellung

CODE: D1 x D2 x H2 x TY-CS x TY-ORK x POS-ORK x TY-RING x MAT



- D1 Innendurchmesser der Dichtung (mm).
- D2 Außendurchmesser der Dichtung (mm).
- H2 Höhe der Dichtung (mm).
- TY-CS Art der Dichtung (siehe Zeichnung).
- TY-ORK..... O-Ring Typ:
 - R = rund*
 - S = quadratisch*
 - Q = kreuzförmig*
- POS-ORK Position vom O-Ring:
 - I = innen*
 - O = außen*
- TY-RING Art des dynamischen Ring:
 - O = offen*
 - C = geschlossen*
- MAT..... Material der Dichtung:
 - PTFE NBR = Teflon + Gummi*
 - PB NBR = Teflon mit Bronze + Gummi*
 - PU NBR = Polyurethan + Gummi*
 - TURCON NBR = Spezial teflon (blau-grüne Farbe) + Gummi*
 - Andere Kombinationen möglich: VIT = Viton anstelle von NBR*

Siehe technische Datenblätter auf Englisch.



PISTON SEAL

PISTON SEAL

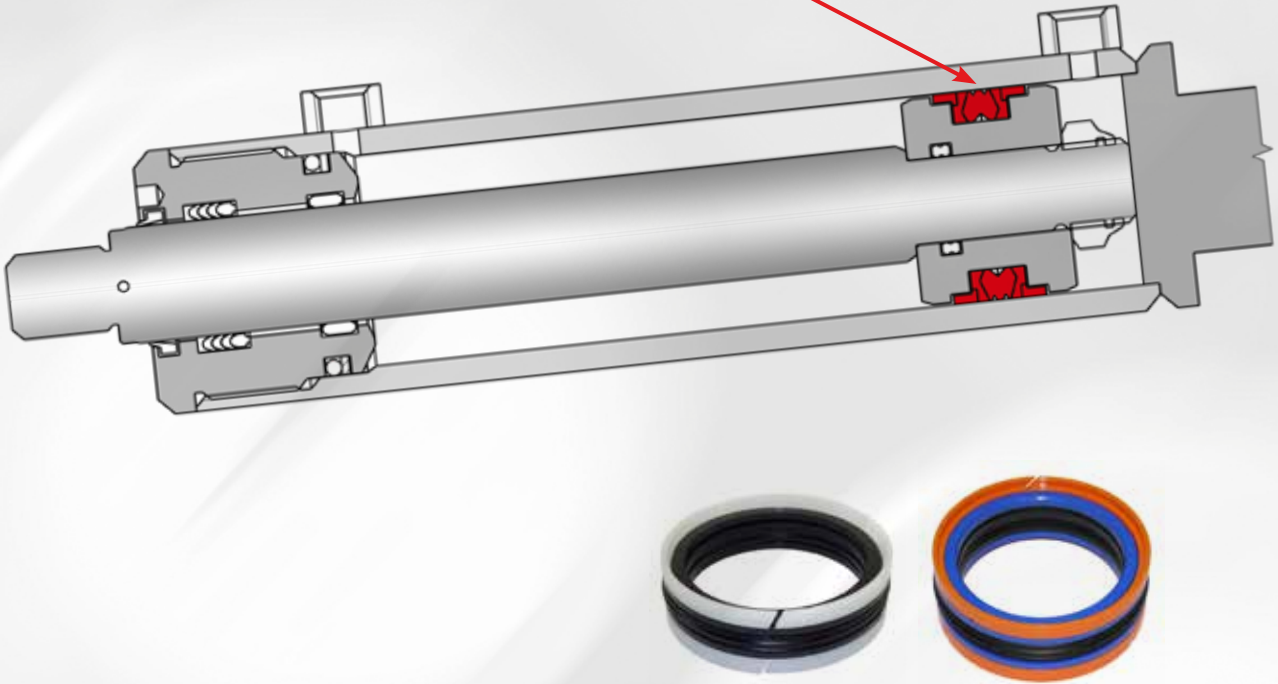

PISTON SEAL

Refine search

Total length piston seal L3 (mm):

Build-in length guide ring L2 (mm):

Build-in length sealing ring L1 (mm):

Search results

TVHNumber	D1	D2	L3	L2	L1	TY	D3	D4	L6	L5	L4	QTY-EL
3759385	€ ⓘ	30	21	17.7	2.1	13.5 P02						5
8261872	€ ⓘ	30	17	28.1	6.35	15.4 P02						5
14788822	€ ⓘ	30	22	19.9	3.2	13.5 P02						3

MyProductSearch: Use technical details or specifications to find your necessary parts.
 No part number, no brand, no type of truck?
 Identify your parts by means of specifications or technical info.





TECHNICAL DETAIL: PISTON SEAL

Group
03-03-06-00

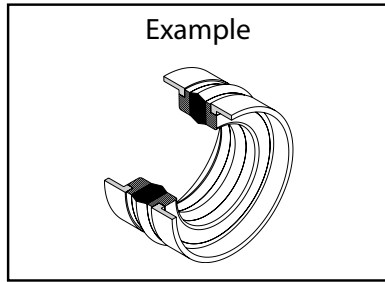

Customer details

Type machine:
Serial n° machine:

Price inquiry
Order

CODE: TY x D1 x D2 x L1 x L2 x L3 x D3 x D4 x L4 x L5 x L6 x QTY-EL

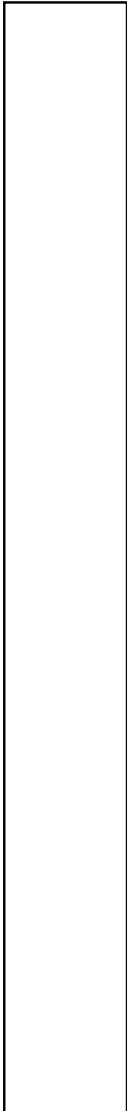

- TY..... Type piston seal.
- D1 Outer diameter (mm).
- D2 Inner diameter (mm).
- L1 Build-in length sealing ring (mm).
- L2..... Build-in length guide (mm).
- L3..... Total length piston seal (mm).
- D3 Outer diameter (inch).
- D4 Inner diameter (inch).
- L4..... Build-in length guide (inch).
- L5..... Build-in length sealing ring (inch).
- L6..... Total length piston seal (inch).
- QTY-EL Number of elements.



TECHNICAL DETAIL: PISTON SEAL

3-piece

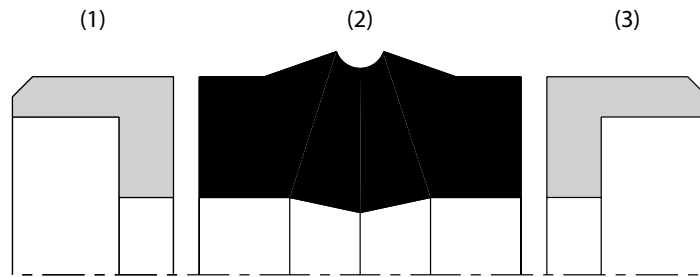

4-piece

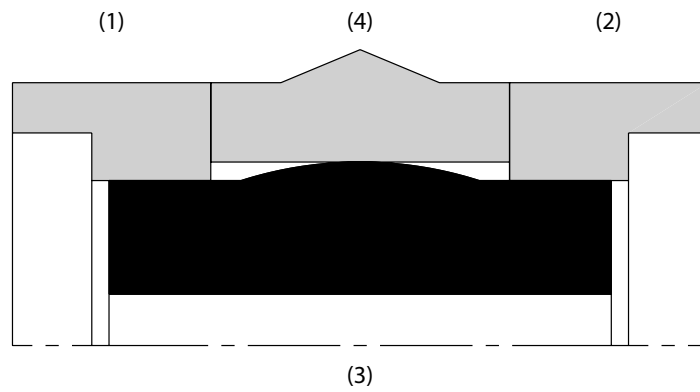

5-piece

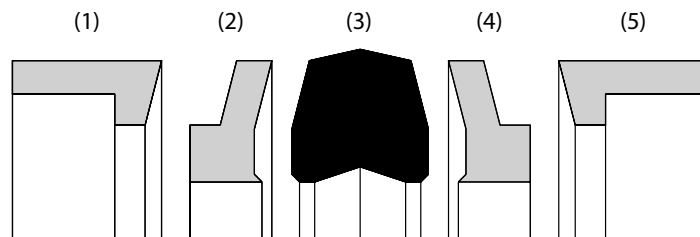



TECHNICAL DETAIL: PISTON SEAL

DIMENSIONS

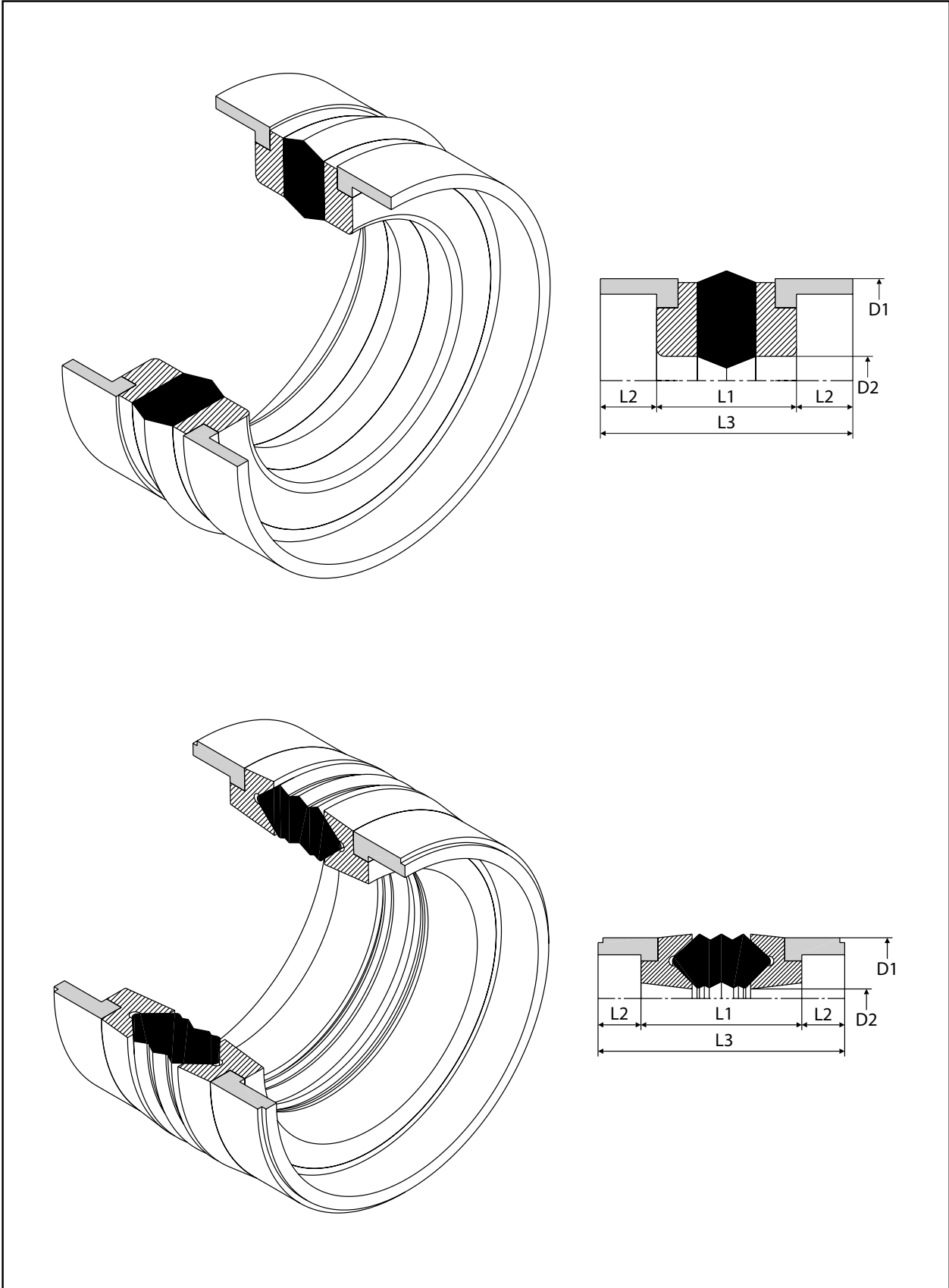



TECHNICAL DETAIL: PISTON SEAL

TYPES

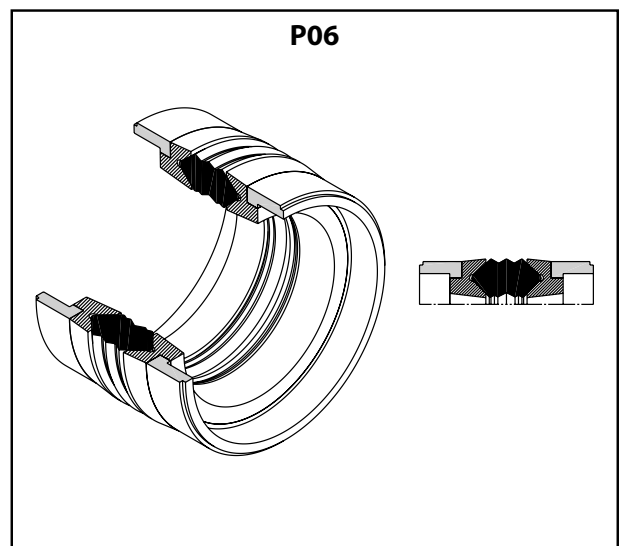
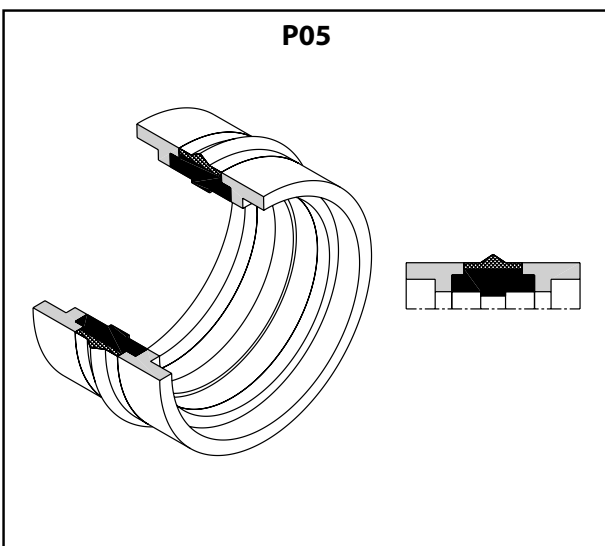
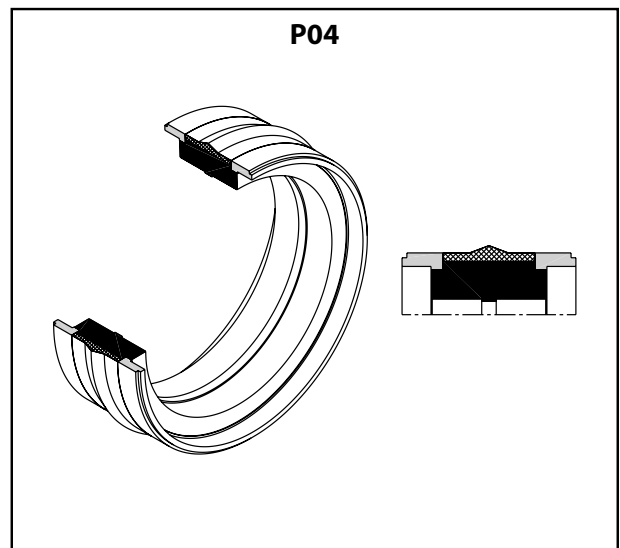
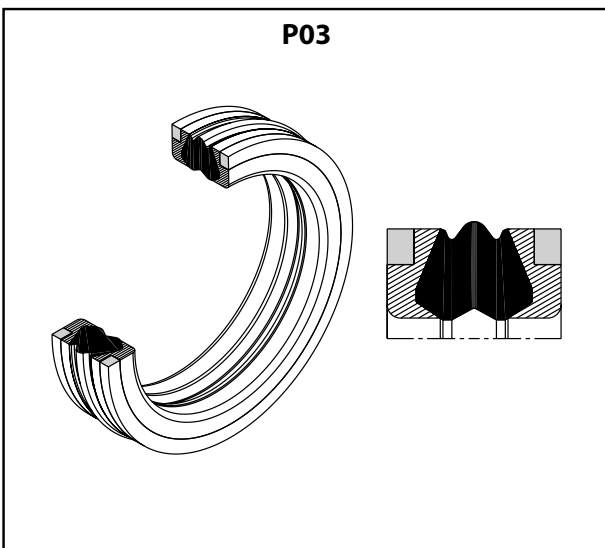
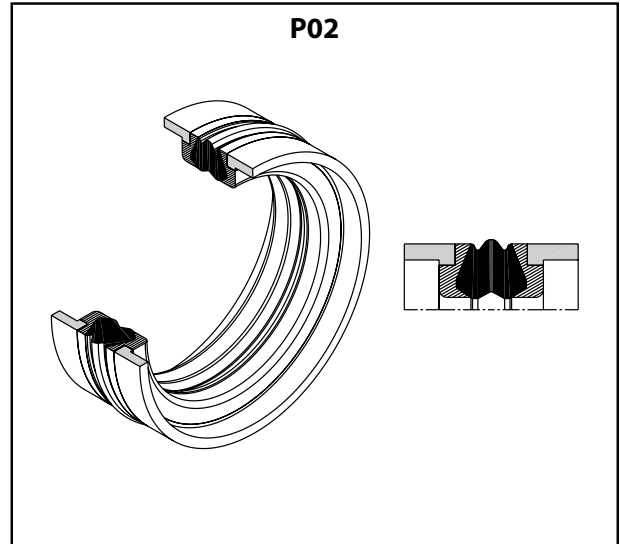
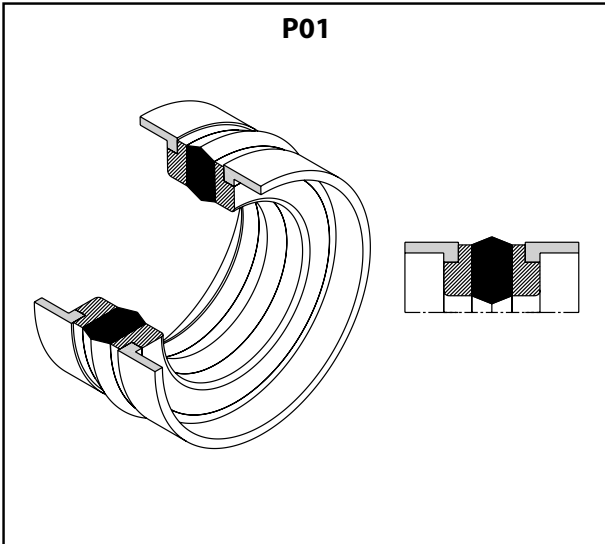



TECHNICAL DETAIL: PISTON SEAL

TYPES

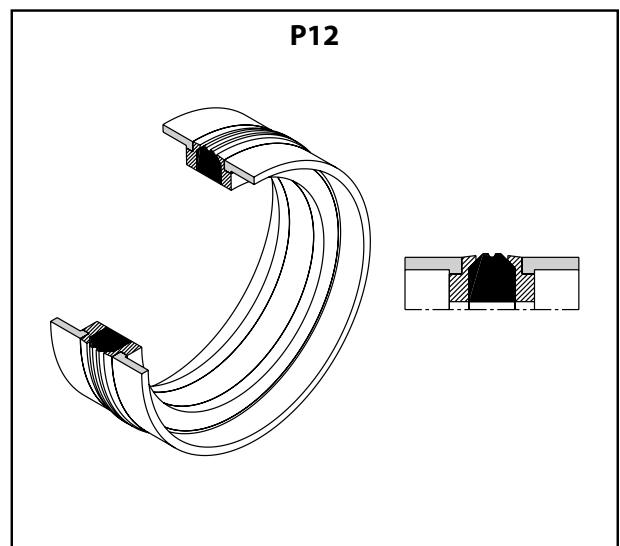
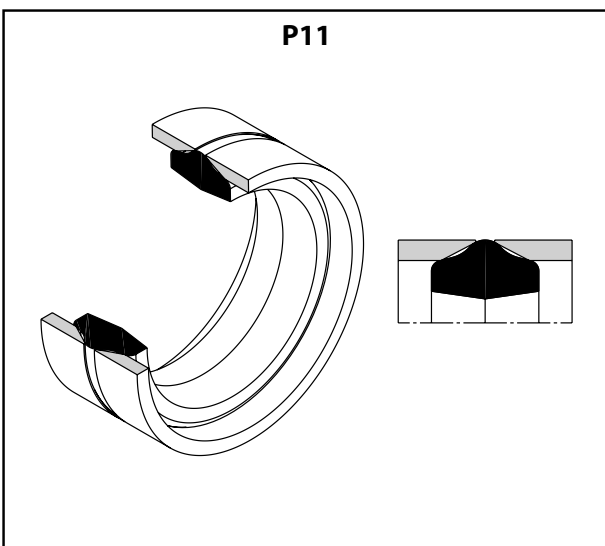
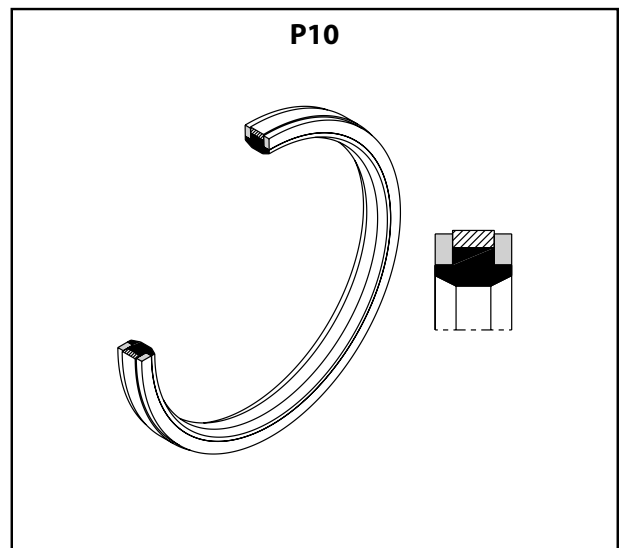
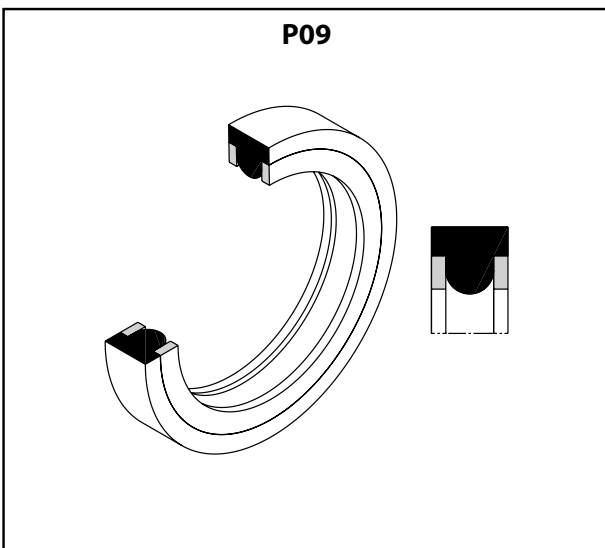
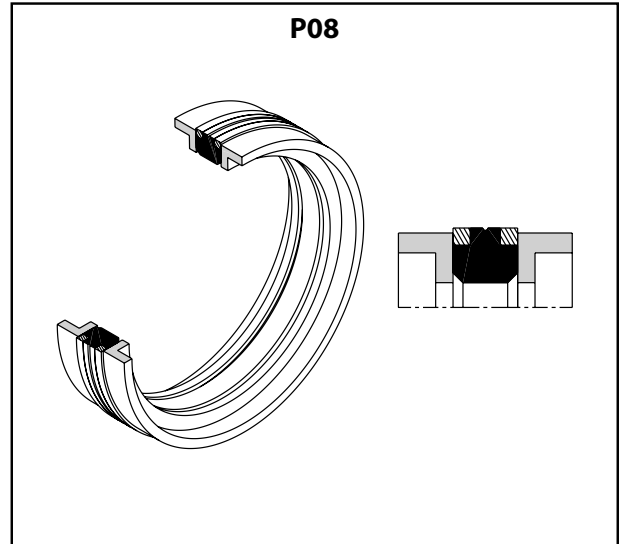
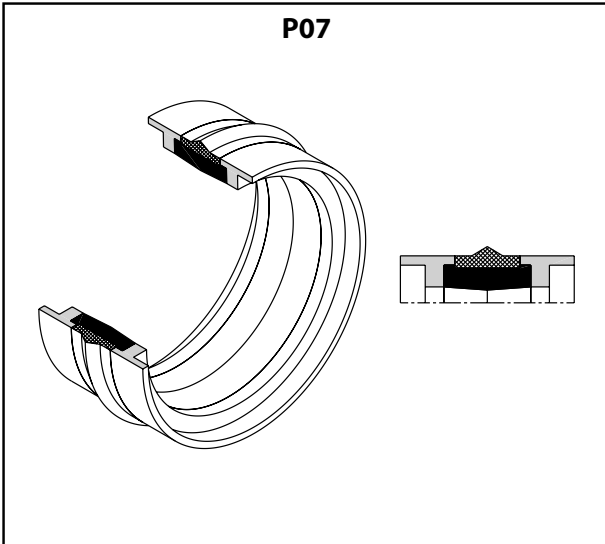



TECHNICAL DETAIL: PISTON SEAL

TYPES

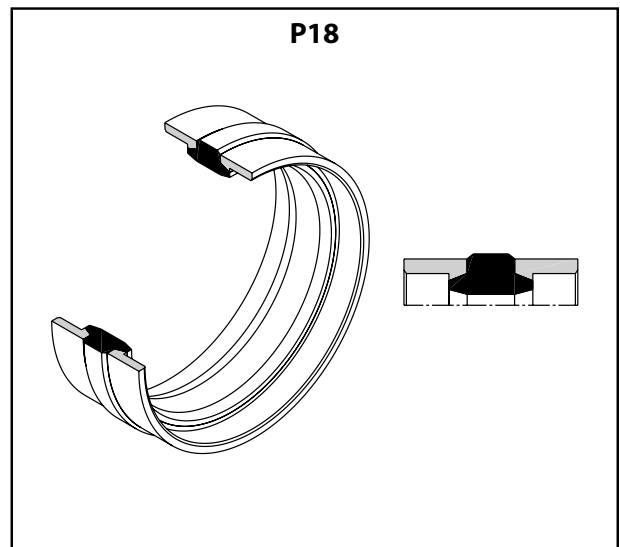
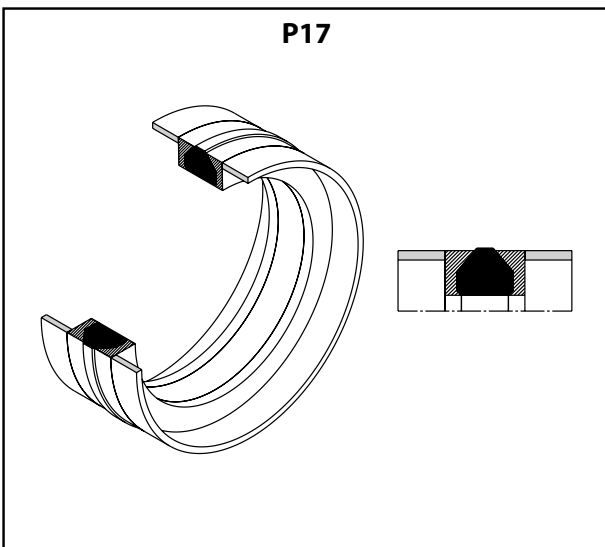
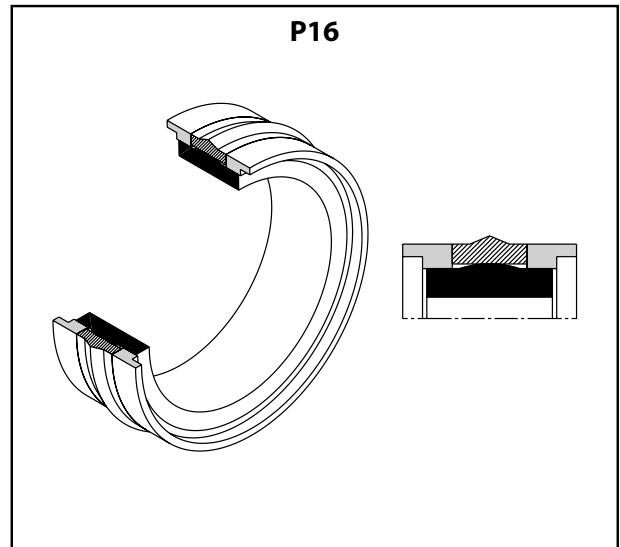
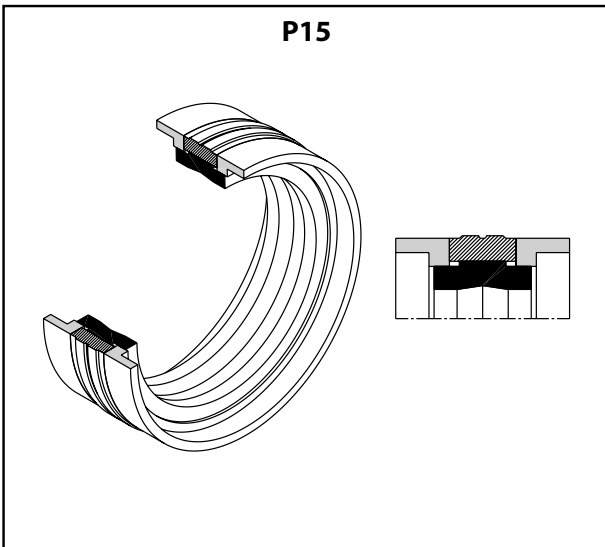
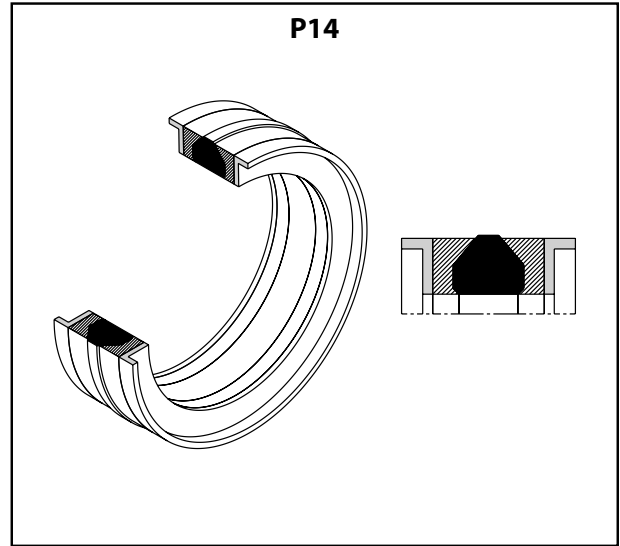
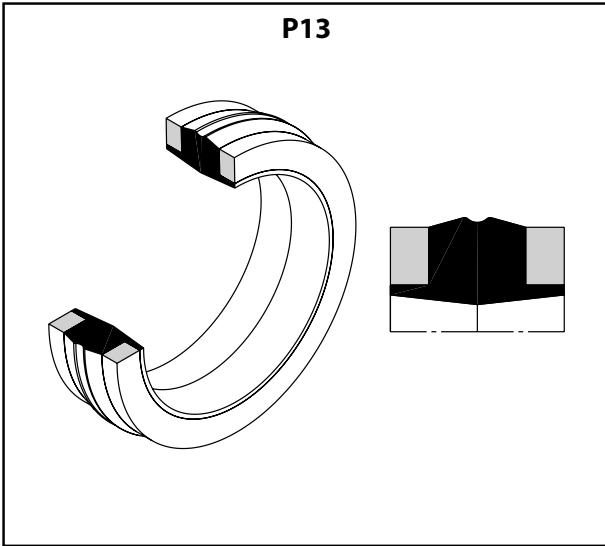



TECHNICAL DETAIL: PISTON SEAL

TYPES

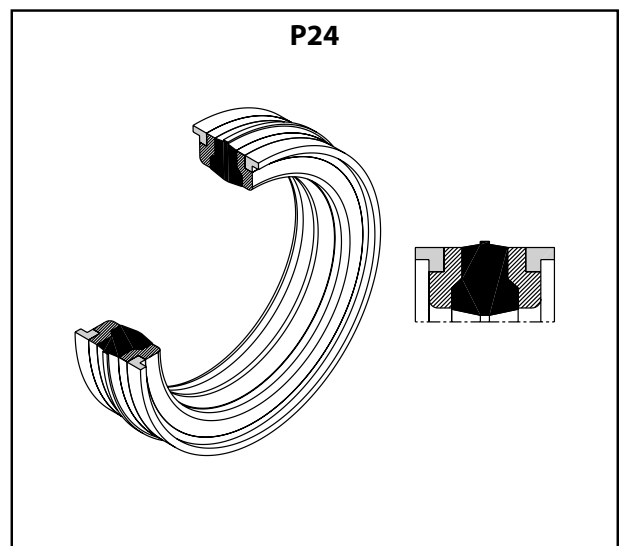
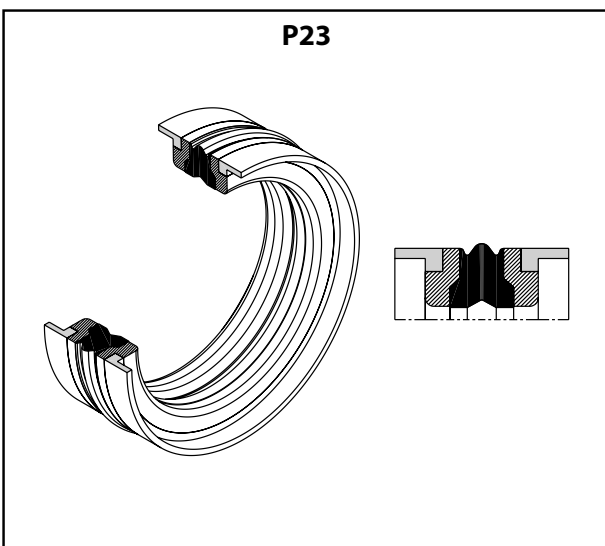
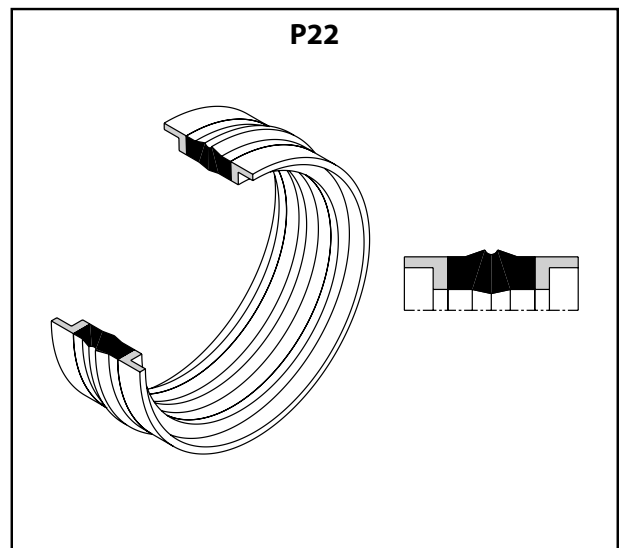
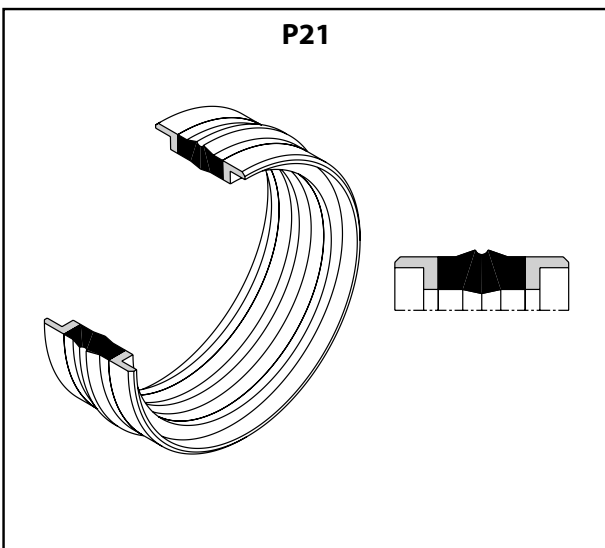
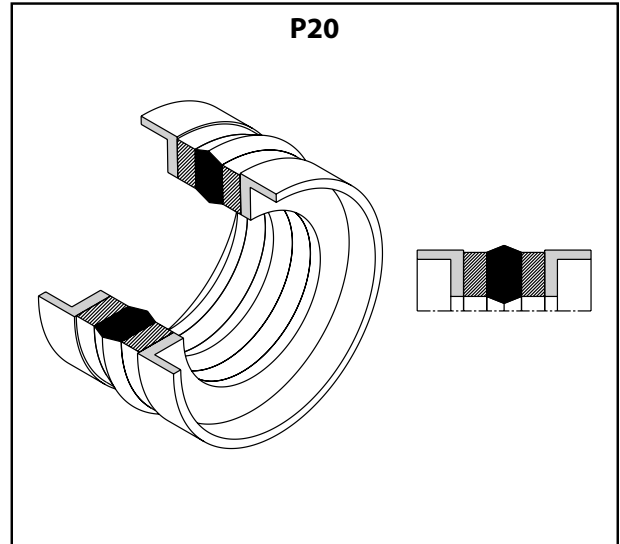
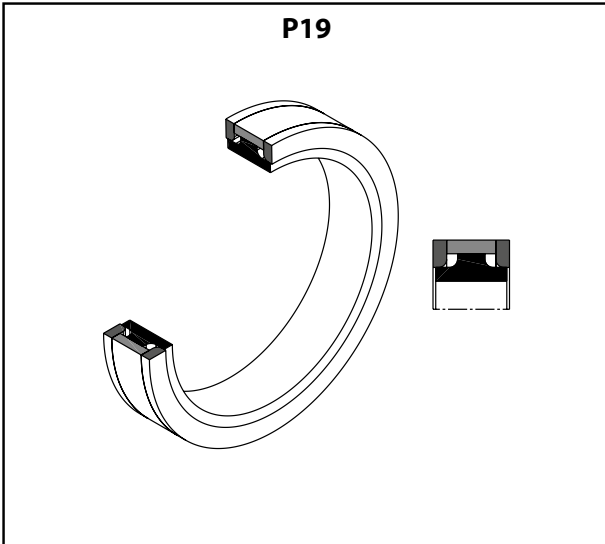



TECHNICAL DETAIL: PISTON SEAL

TYPES

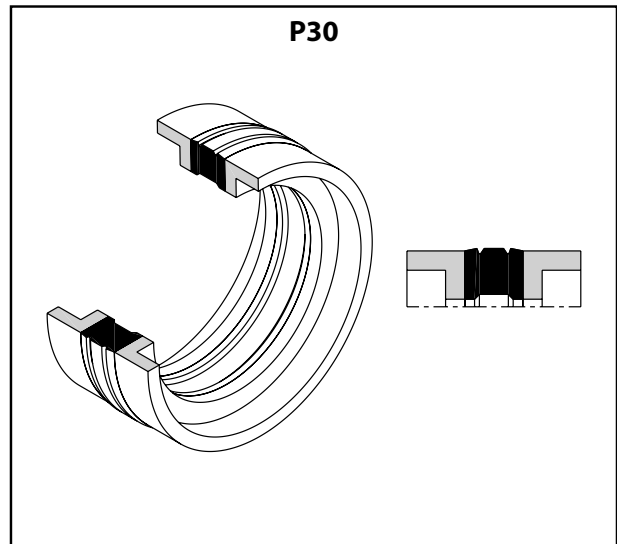
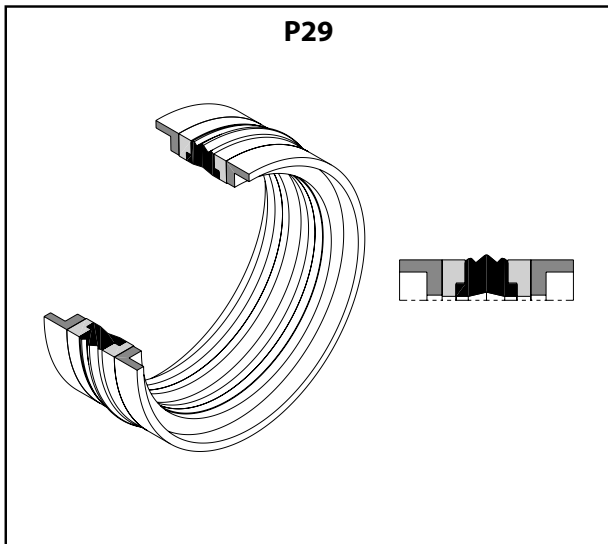
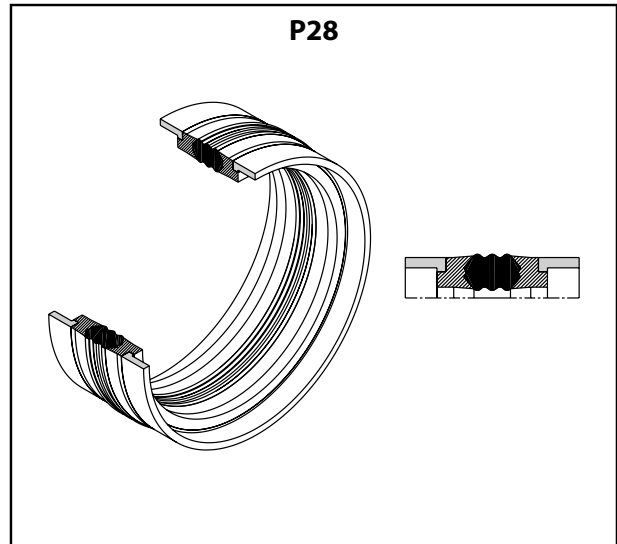
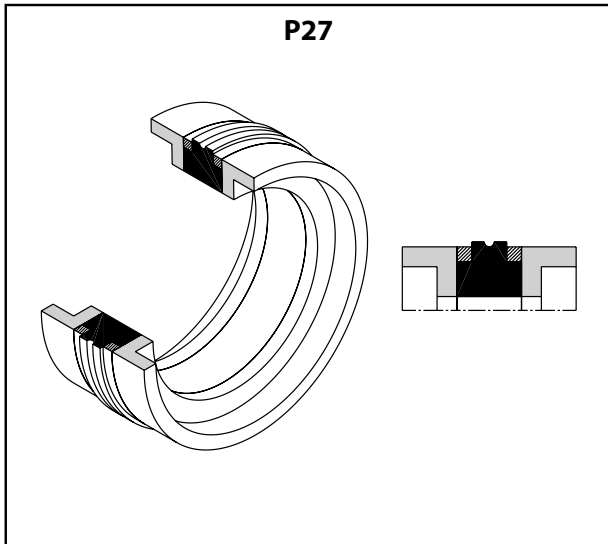
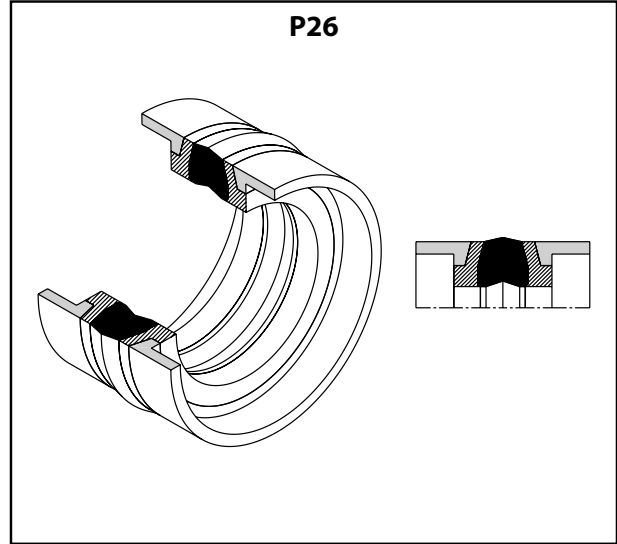
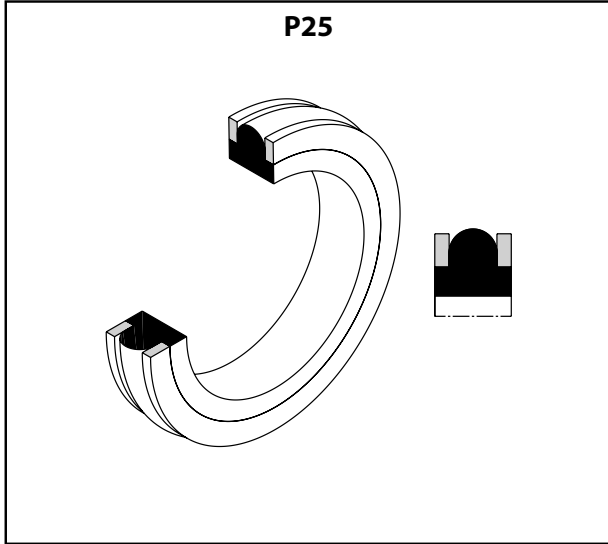



TECHNICAL DETAIL: PISTON SEAL

TYPES

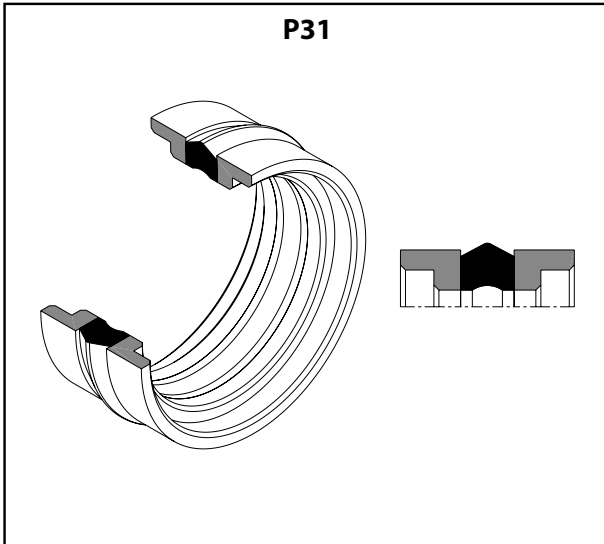



TECHNICAL DETAIL: PISTON SEAL

Groep
03-03-06-00

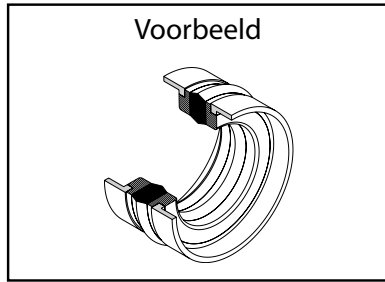

Gegevens klant

Type machine:
 Serienr. machine:

Prijsaanvraag
 Bestelling

CODE: TY x D1 x D2 x L1 x L2 x L3 x D3 x D4 x L4 x L5 x L6 x QTY-EL

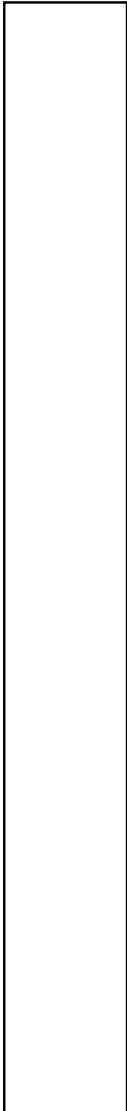

- TY..... Type zuigerafdichting.
- D1 Buitendiameter (mm).
- D2 Binnendiameter (mm).
- L1 Inbouwlengte van het afdichtingselement (mm).
- L2..... Inbouwlengte van de geleidingsring (mm).
- L3..... Totale lengte van de zuigerafdichting (mm).
- D3 Buitendiameter (inch).
- D4 Binnendiameter (inch).
- L4..... Inbouwlengte van de geleidingsring (inch).
- L5..... Inbouwlengte van het afdichtingselement (inch).
- L6..... Totale lengte van de zuigerafdichting (inch).
- QTY-EL Aantal elementen.

zie Engelse technische fiche !



TECHNICAL DETAIL: PISTON SEAL

Groupe
03-03-06-00

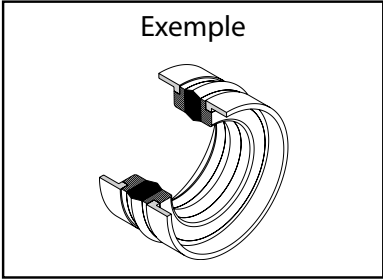

Données client

Type machine :
No. série machine :

Demande de prix
Commande

CODE : TY x D1 x D2 x L1 x L2 x L3 x D3 x D4 x L4 x L5 x L6 x QTY-EL



- TY..... Type de joint de piston.
- D1 Diamètre extérieur (mm).
- D2 Diamètre intérieur (mm).
- L1 Longueur de montage de la bague d'étanchéité (mm).
- L2..... Longueur de montage de la bague de guidage (mm).
- L3..... Longueur totale du joint de piston (mm).
- D3 Diamètre extérieur (inch).
- D4 Diamètre intérieur (inch).
- L4..... Longueur de montage de la bague de guidage (inch).
- L5..... Longueur de montage de la bague d'étanchéité (inch).
- L6..... Longueur totale du joint de piston (inch).
- QTY-EL Nombre d'éléments.

voir la fiche technique en Anglais.



TECHNICAL DETAIL: PISTON SEAL

Gruppe
03-03-06-00

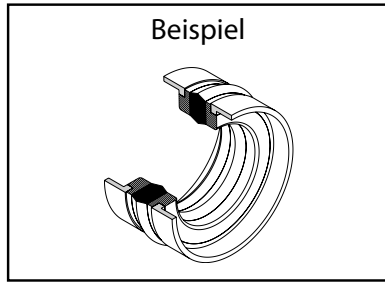

Kundendaten

Maschinentyp:

Preis-anfrage

Serien-Nr. Maschine:

Bestellung

CODE: TY x D1 x D2 x L1 x L2 x L3 x D3 x D4 x L4 x L5 x L6 x QTY-EL



- TY..... Typ von Kolbendichtung.
- D1 Aussendurchmesser (mm).
- D2 Innendurchmesser (mm).
- L1 Einbaulänge vom Gleitring (mm).
- L2..... Einbaulänge vom Gleitring (mm).
- L3..... Gesamtlänge von der Kolbendichtung (mm).
- D3 Aussendurchmesser (inch).
- D4 Innendurchmesser (inch).
- L4..... Einbaulänge vom Gleitring (inch).
- L5..... Einbaulänge vom Gleitring (inch).
- L6..... Gesamtlänge von der Kolbendichtung (inch).
- QTY-EL Anzahl Elemente.

Siehe technische Datenblätter auf Englisch.



GUIDE RING

GUIDE RING

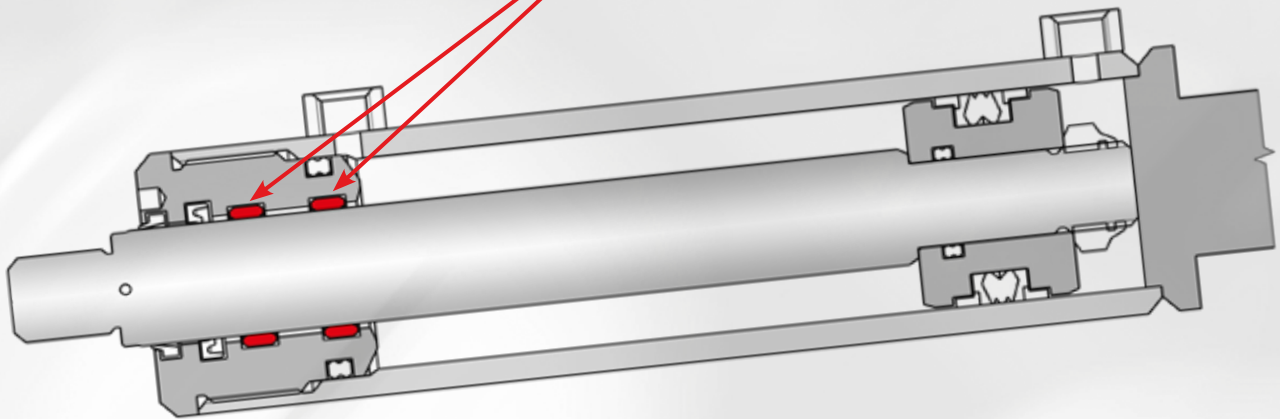

GUIDE RING

Technical drawings showing dimensions: $D1$, $D2$, $D3=D4$, $H1$, $H2$. Cross-sections show $D1=D2$ and $D3=D4$.

Refine search

Biggest inner diameter D3 (mm):

Smallest inner diameter D4 (mm):

[Reset](#) [Next](#) [Tolerances](#)

Search results

TVNNumber	TY-F	LO-R	D1	D2	D3	D4	H1	H2	QTY-CFE	QTY-CFI	MI	MAT
16283092	COMPLETELY ROUND	OPEN	64	62	55	55	12	12				METRIC POLYOXYMETHYLENE
10581782	COMPLETELY ROUND	OPEN	64	62.6	55	55	12	12				METRIC POLYAMIDE
2005569	COMPLETELY ROUND	CROSS	64	63.8	60.0	60.0	12	12				METRIC POLYAMIDE

MyProductSearch: Use technical details or specifications to find your necessary parts. No part number, no brand, no type of truck? Identify your parts by means of specifications or technical info.





TECHNICAL DETAIL: GUIDE RING

Group
03-03-11-01

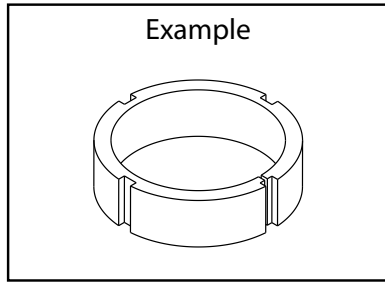

Customer details

Type machine:

Price inquiry

Serial n° machine:

Order

CODE: TY-R x TY-F x LO-R x TY-LO x QTY-HO x QTY-AGR x TY-AGR x QTY-RGR x TY-RGR x
QTY-NOT x TY-NOT x QTY-CFE x QTY-CFI x MI x D1 x D2 x D3 x D4 x H1 x H2 x D5 x D6 x
D7 x D8 x H3 x H4 x MAT

TY-R..... Type of guide ring.

TY-F..... Shape of the guide ring:

A = completely round

B = half-round

C = partially round

LO-R Locking of the guide ring:

C = closed

O = open

TY-LO Type of lock.

QTY-HO Number of holes.

QTY-AGR..... Number of axial grooves.

TY-AGR..... Type of axial grooves, combinations possible.

QTY-RGR Number of radial grooves.

TY-RGR..... Type of radial grooves, combinations possible.

QTY-NOT..... Number of notches.

TY-NOT..... Type of notches.

QTY-CFE..... Number of external chamfers/roundings.

QTY-CFI Number of internal chamfers/roundings.

MI..... Unit of measurement:

M = metric

I = imperial



TECHNICAL DETAIL: GUIDE RING

- D1 Biggest outer diameter (mm).
- D2 Smallest outer diameter (mm).
- D3 Biggest inner diameter (mm).
- D4 Smallest inner diameter (mm).
- H1 Maximum height (mm).
- H2 Minimum height (mm).
- D5 Biggest outer diameter (inch).
- D6 Smallest outer diameter (inch).
- D7 Biggest inner diameter (inch).
- D8 Smallest inner diameter (inch).
- H3 Maximum height (inch).
- H4 Minimum height (inch).
- MAT..... Material:
 - EP = epratex*
 - PA = polyamide*
 - PB = polytetrafluoroethylene with bronze*
 - PC = polycarbonate*
 - POM = polyoxymethylene*
 - PTFE = polytetrafluoroethylene*
 - PU = polyurethane*
 - RP = phenolic resin*



TECHNICAL DETAIL: GUIDE RING

TY-R: TYPE OF GUIDE RING

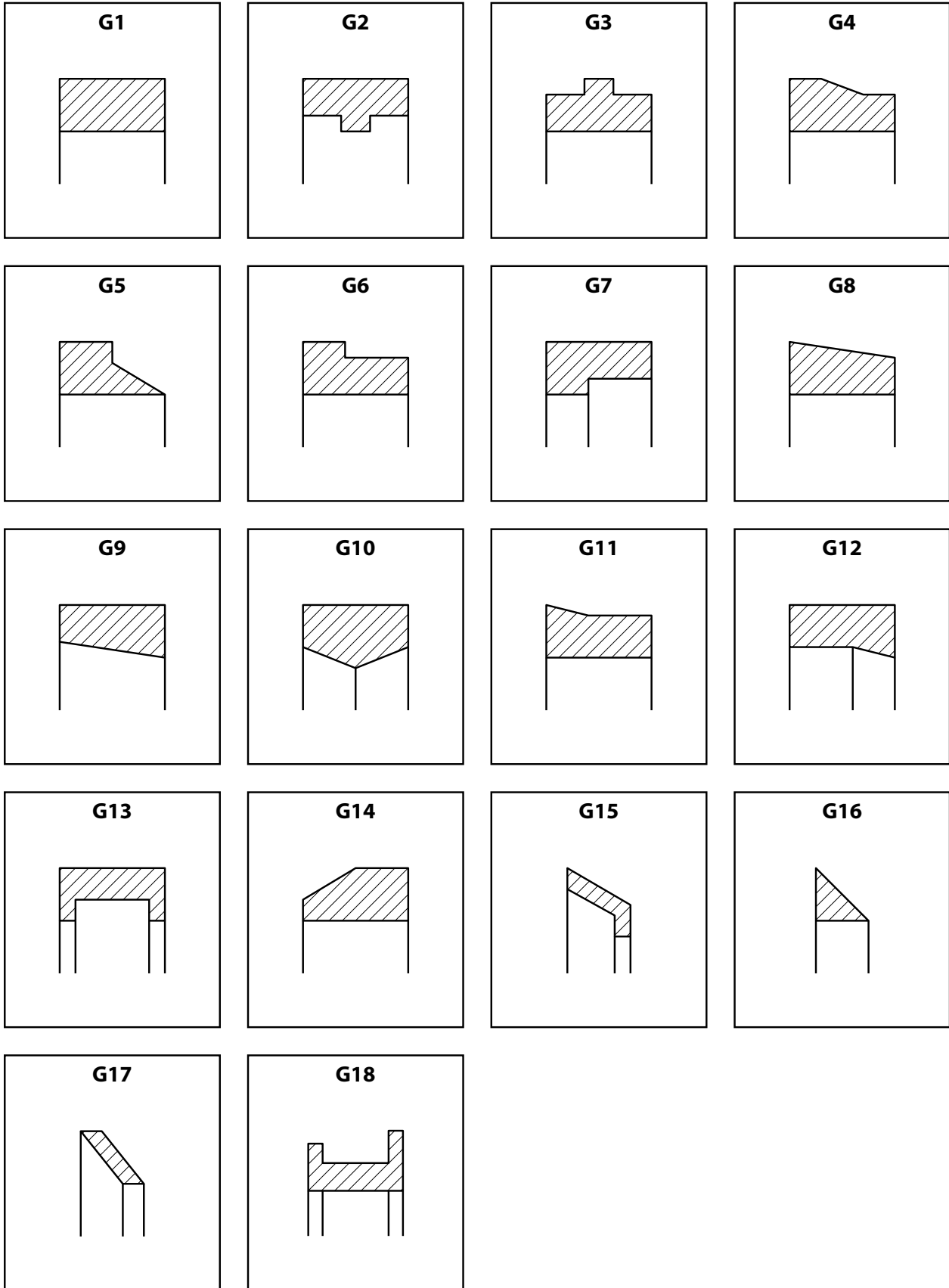



TECHNICAL DETAIL: GUIDE RING

TY-F: SHAPE OF THE GUIDE RING

A = completely round

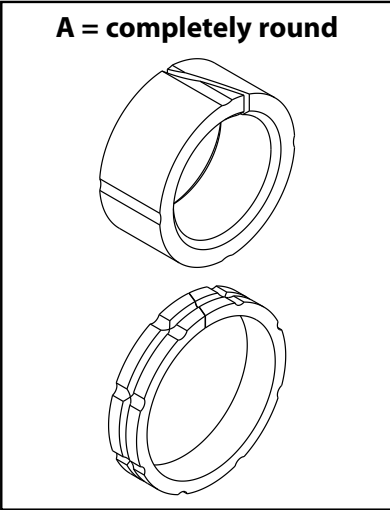

B = half-round

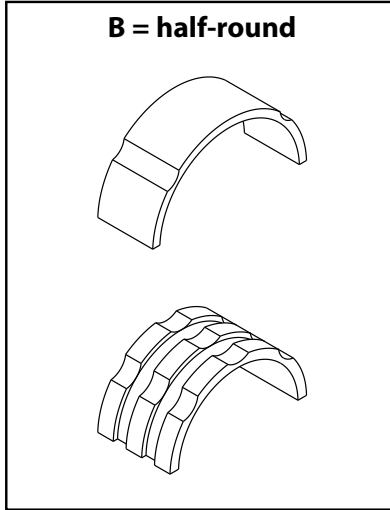

C = partially round

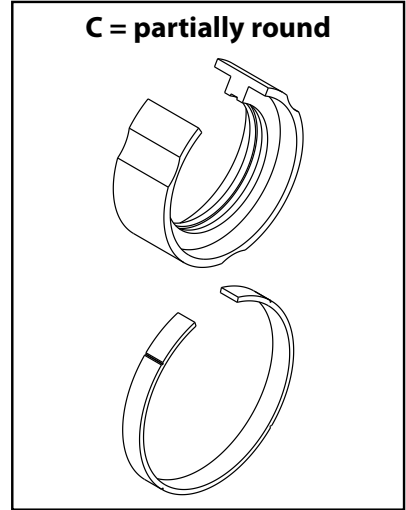

LO-R: LOCKING OF THE GUIDE RING

C = closed

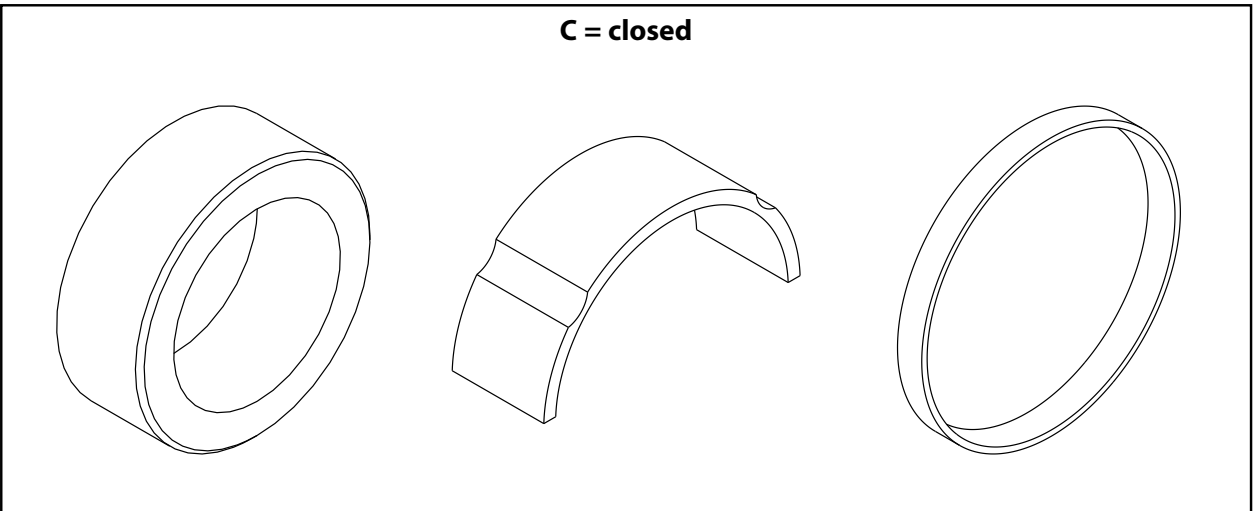

O = open

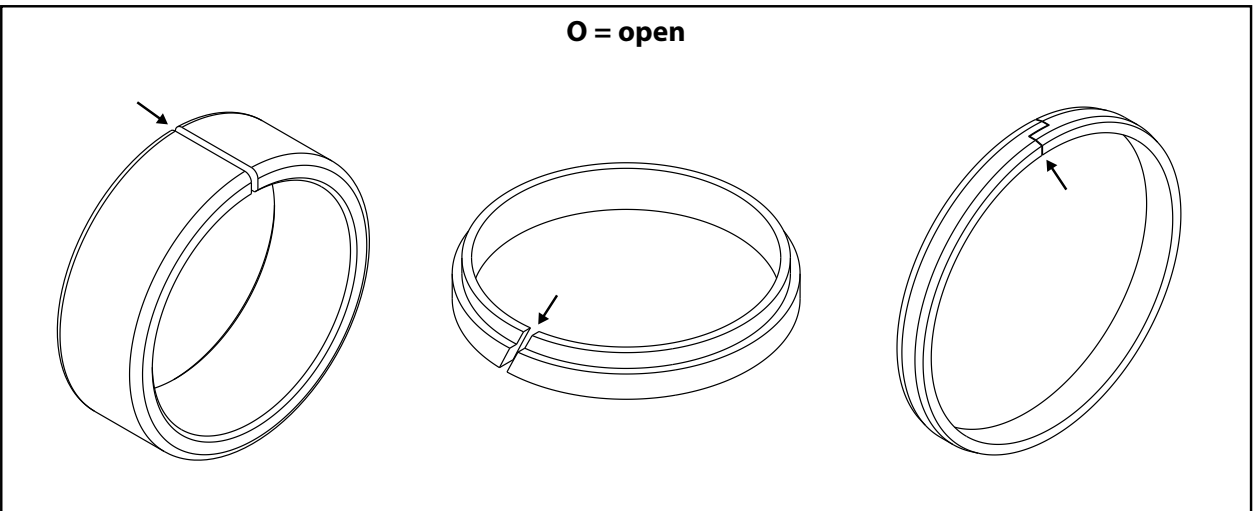



TECHNICAL DETAIL: GUIDE RING

TY-LO: TYPE OF LOCK

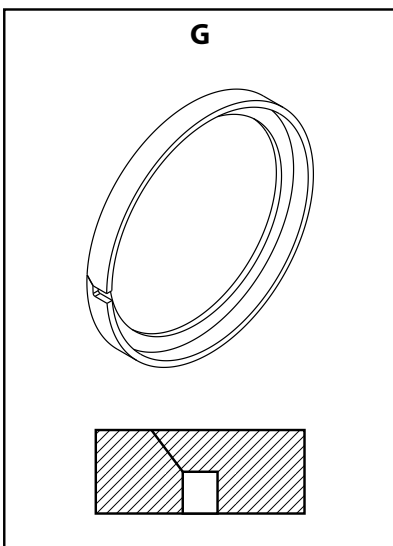
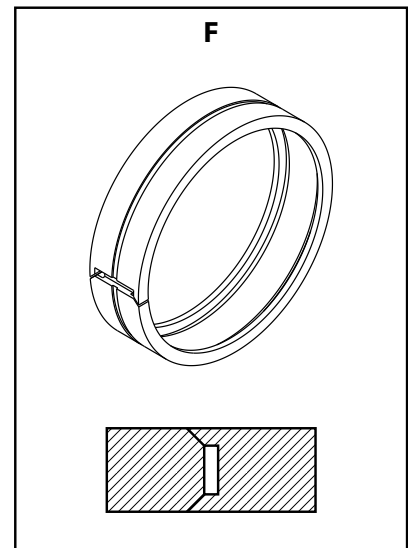
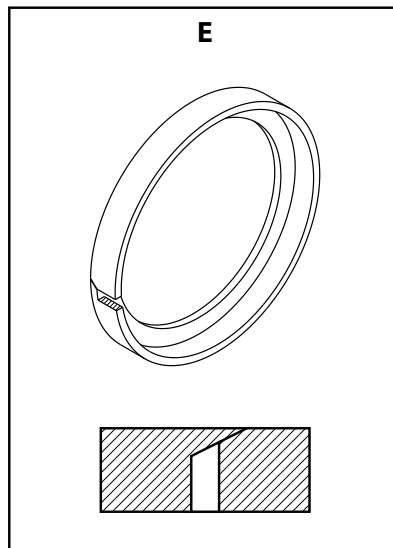
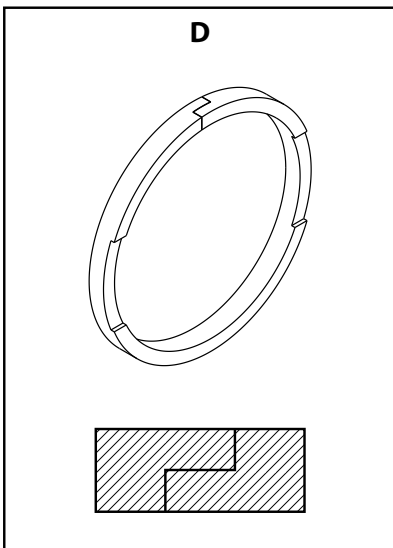
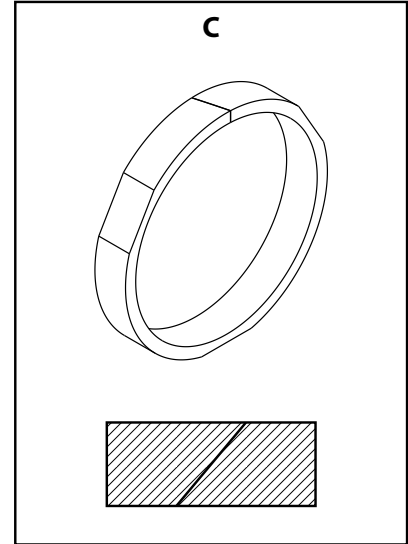
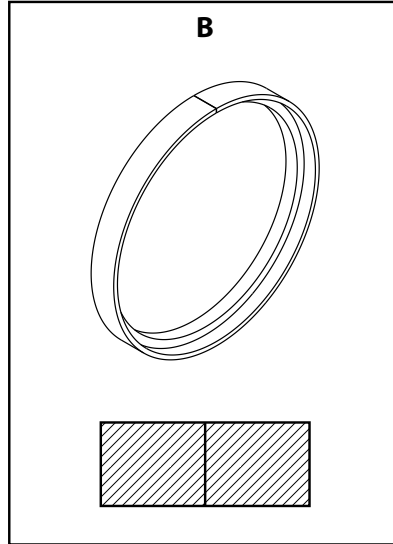
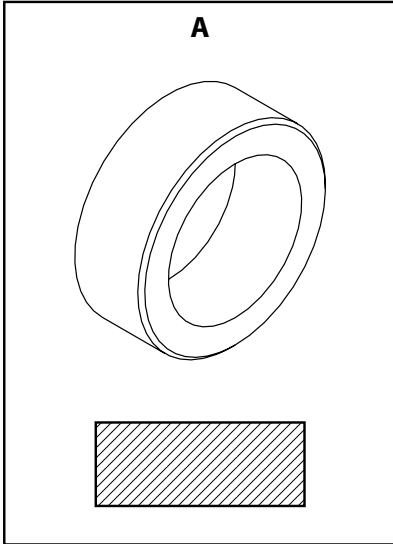



TECHNICAL DETAIL: GUIDE RING

QTY-HO: NUMBER OF HOLES

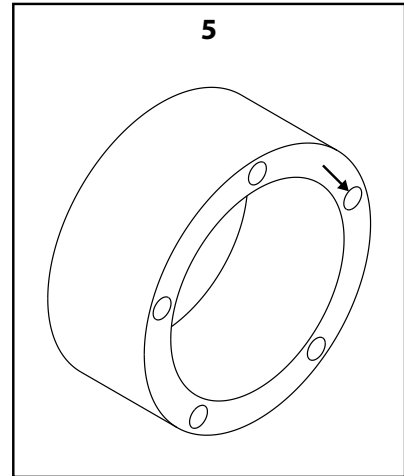
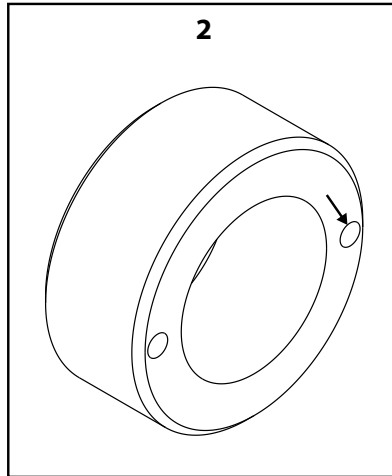
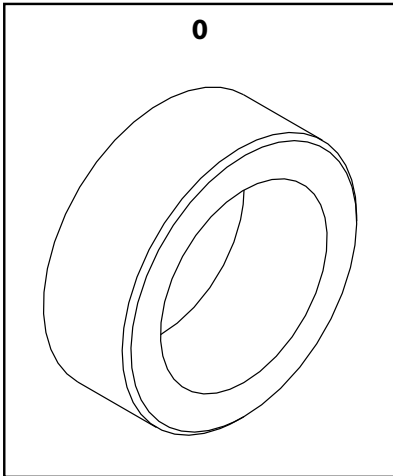

QTY-AGR: NUMBER OF AXIAL GROOVES

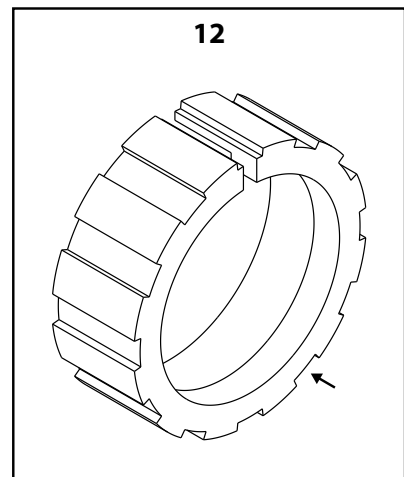
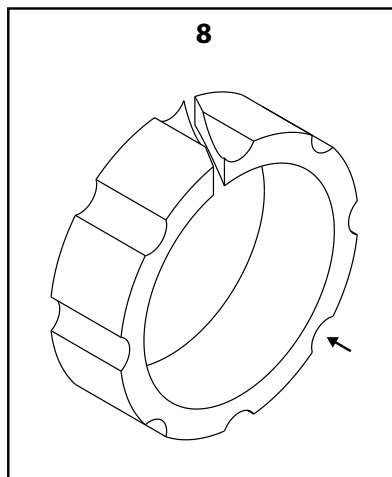
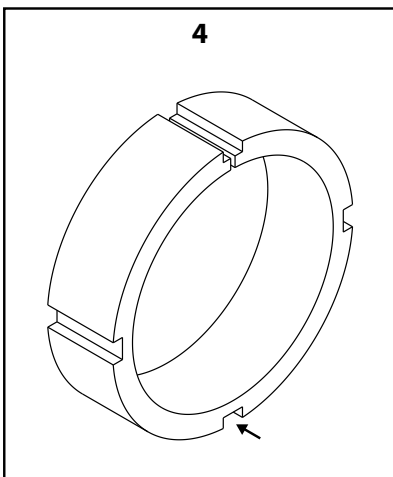

QTY-RGR: NUMBER OF RADIAL GROOVES

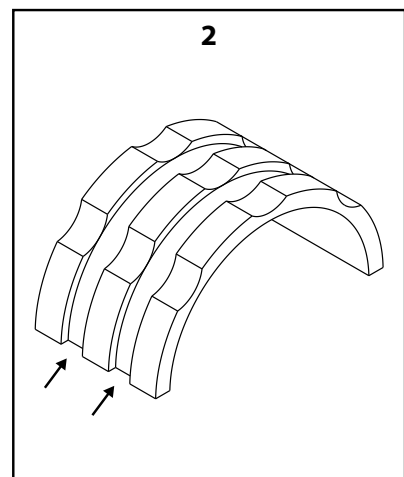
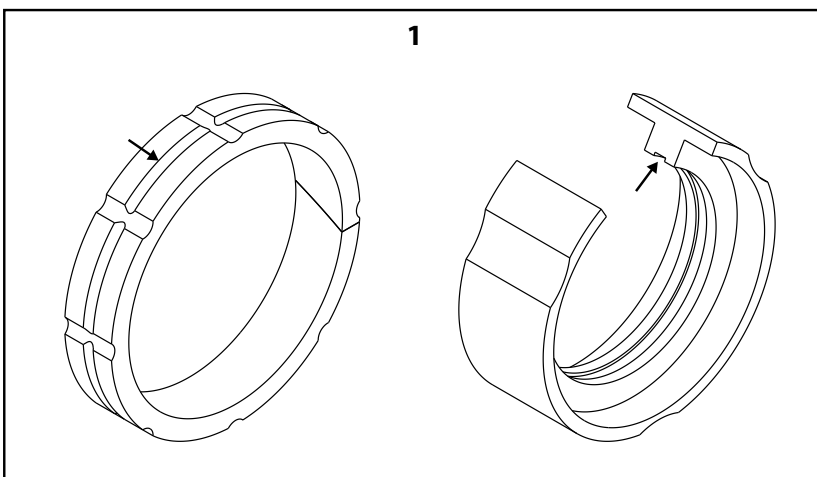



TECHNICAL DETAIL: GUIDE RING

TY-AGR: TYPE OF AXIAL GROOVES

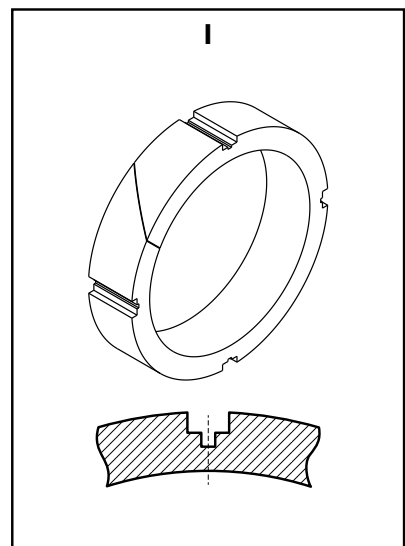
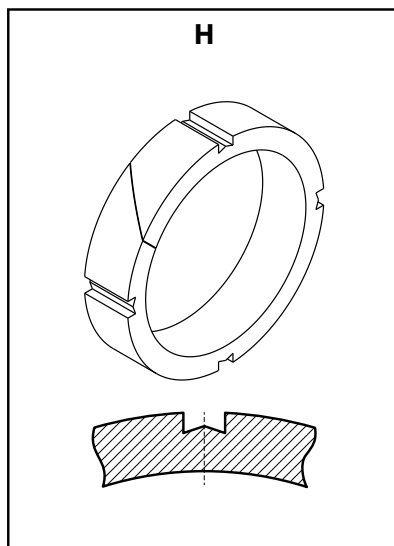
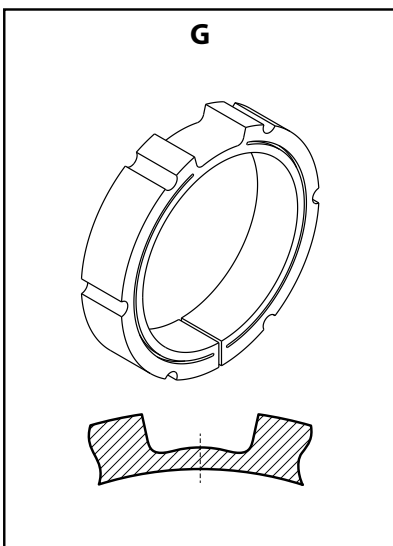
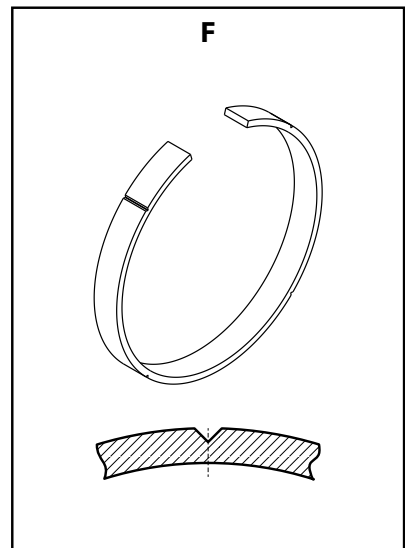
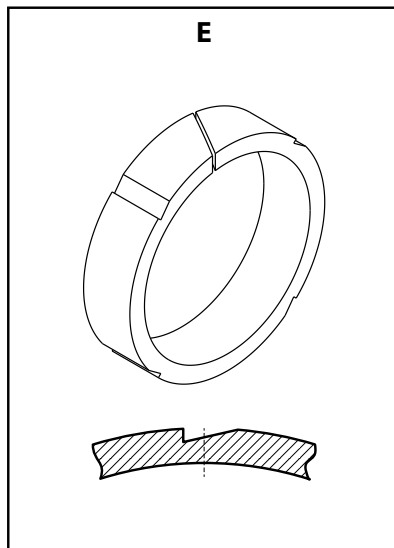
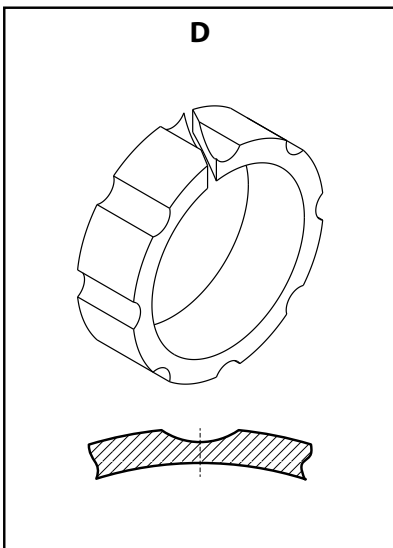
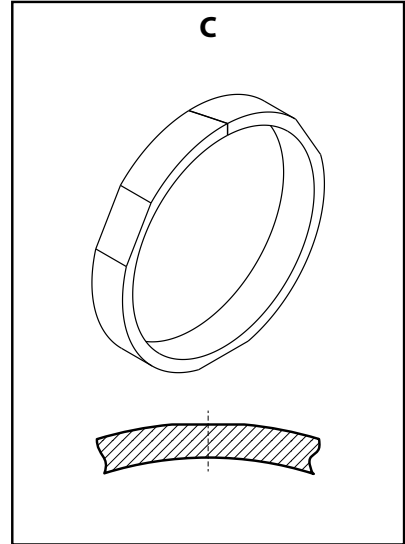
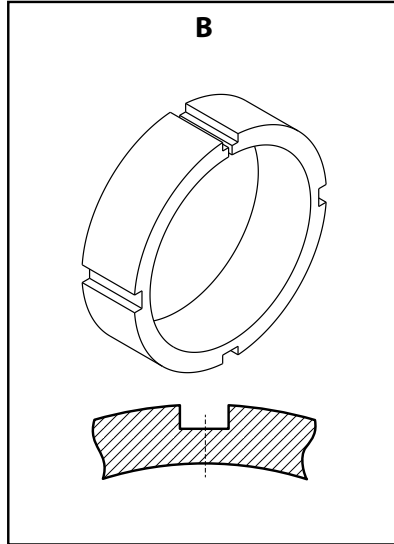
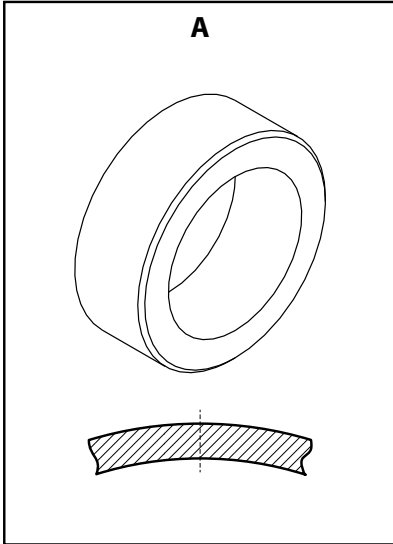



TECHNICAL DETAIL: GUIDE RING

TY-RGR: TYPE OF RADIAL GROOVES

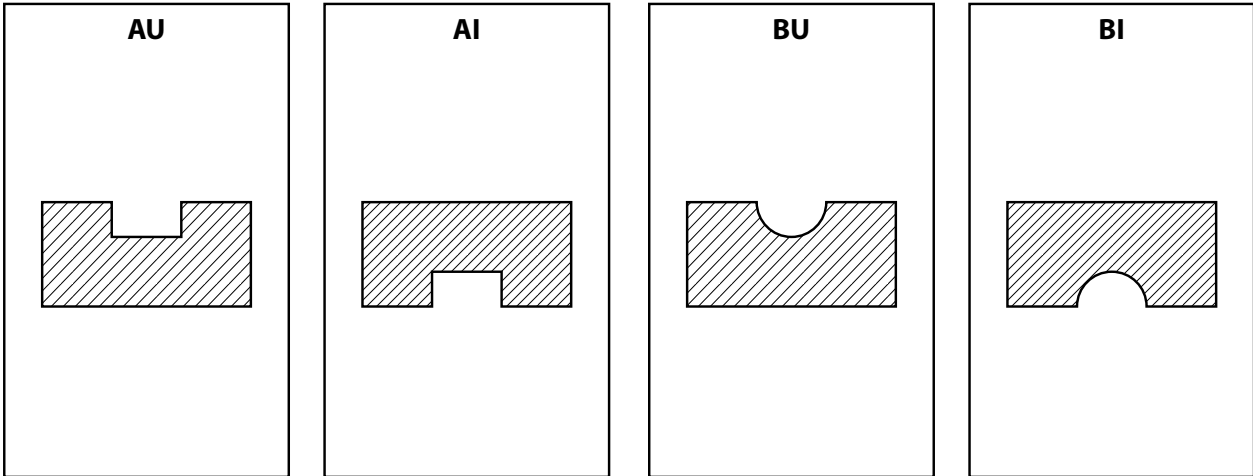

QTY-NOT: NUMBER OF NOTCHES

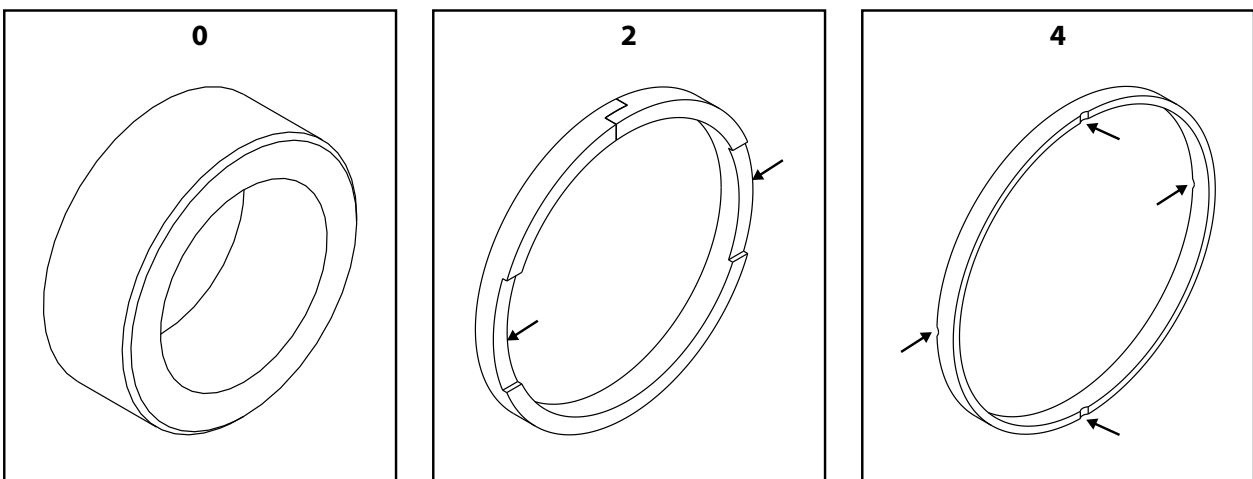

TY-NOT: TYPE OF NOTCHES

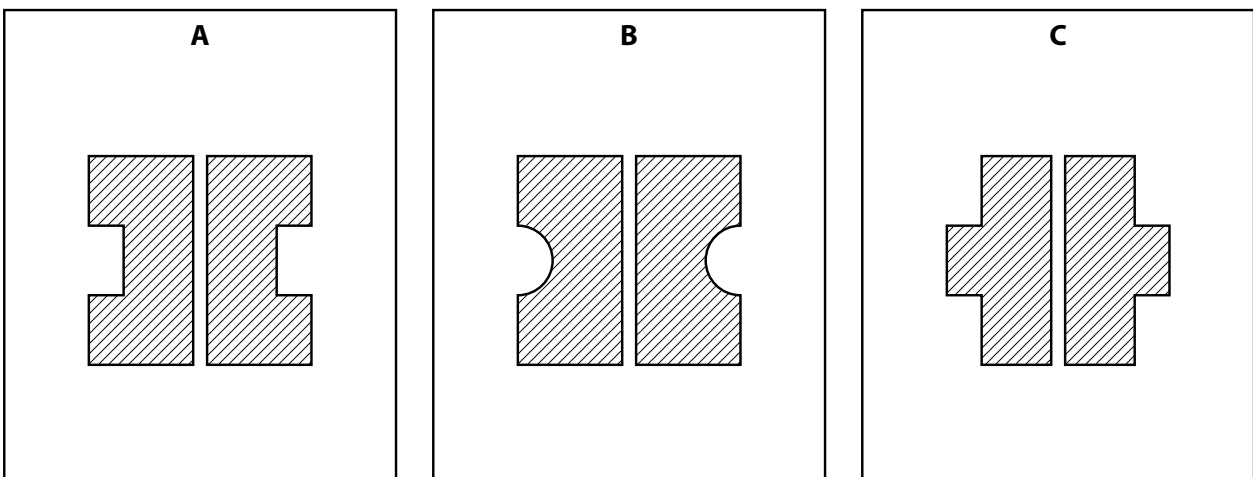



TECHNICAL DETAIL: GUIDE RING

QTY-CFE: NUMBER OF EXTERNAL CHAMFERS/ROUNDINGS

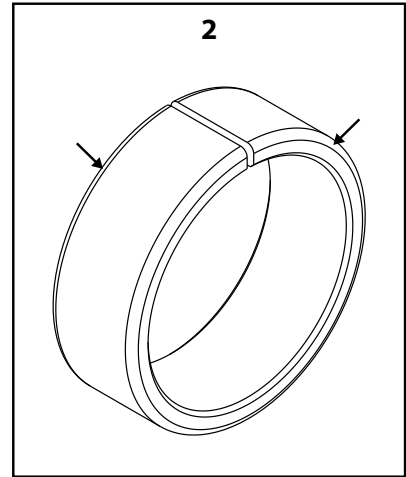
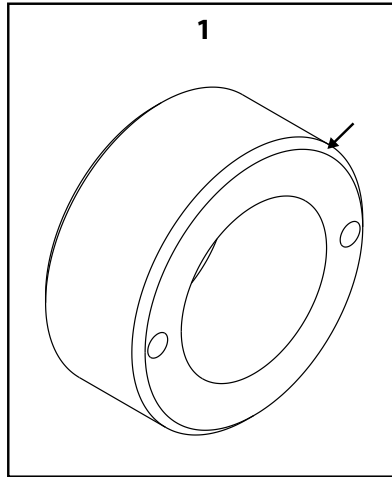
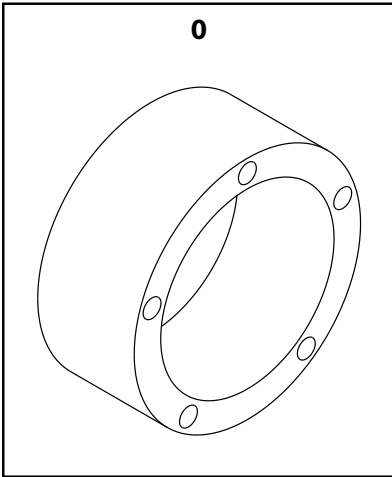

QTY-CFI: NUMBER OF INTERNAL CHAMFERS/ROUNDINGS

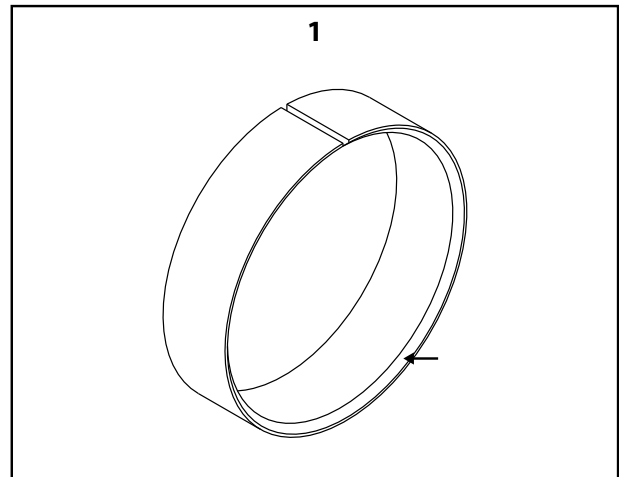
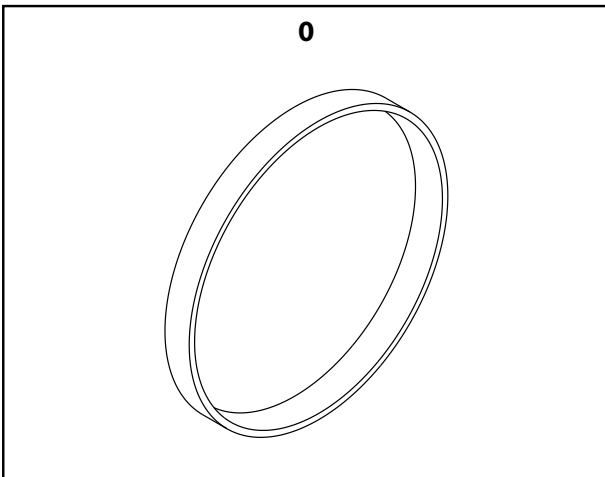



TECHNICAL DETAIL: GUIDE RING

DIMENSIONS

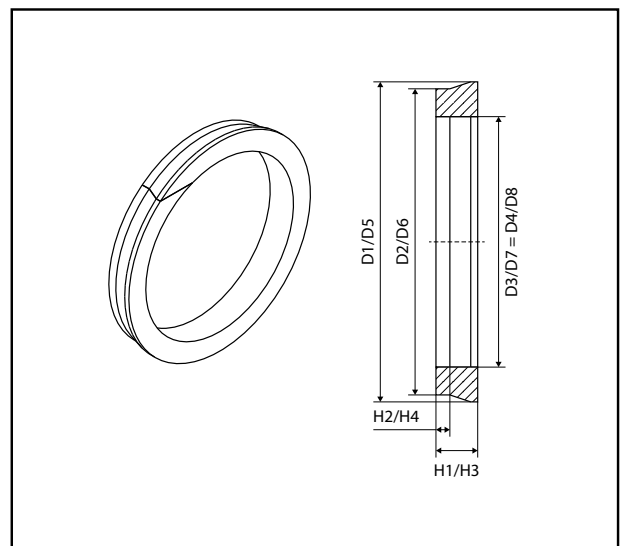
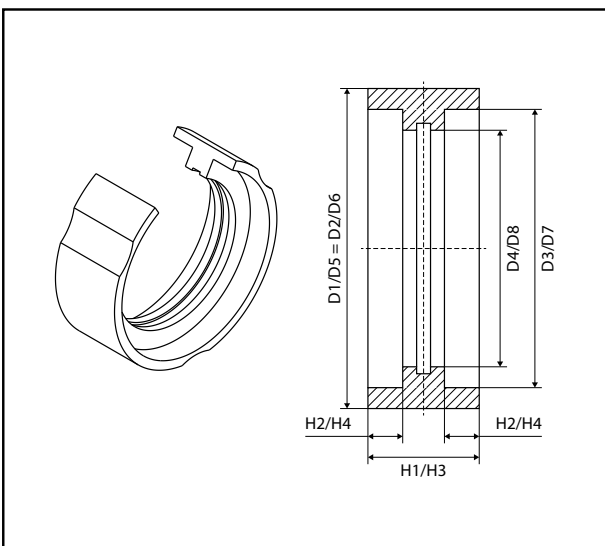
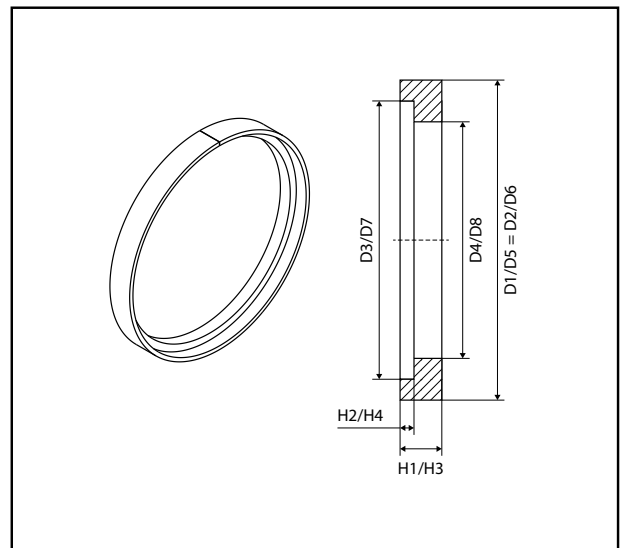
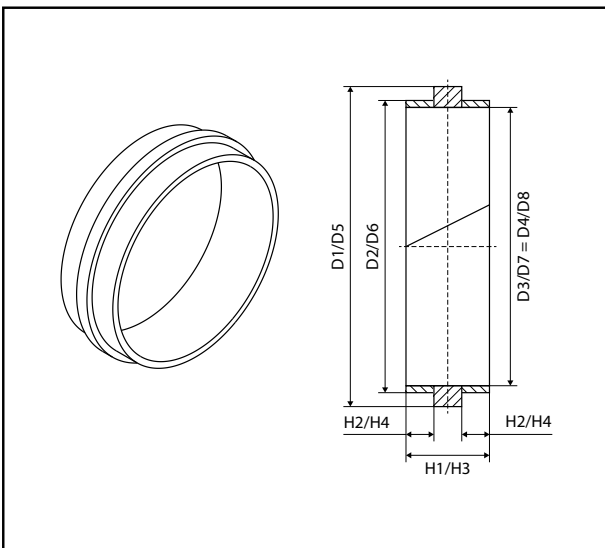
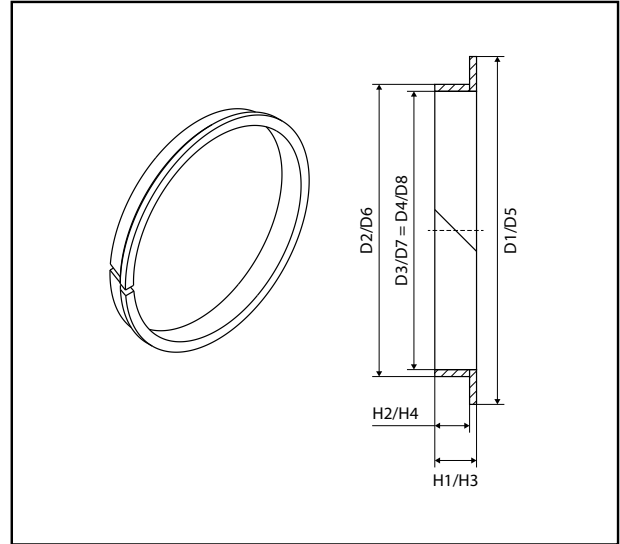
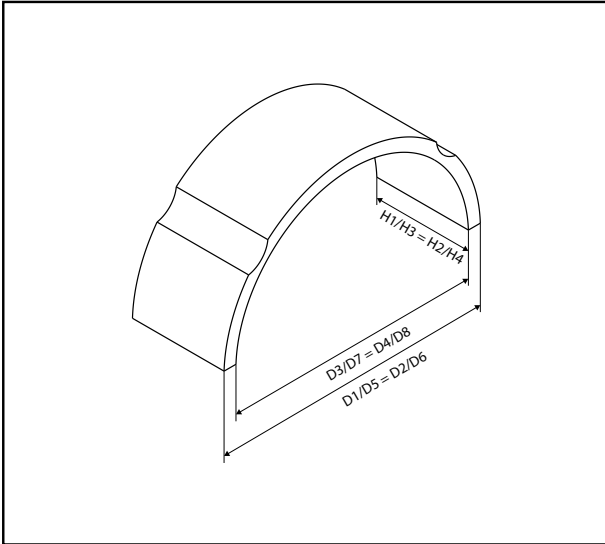



TECHNICAL DETAIL: GUIDE RING

Groep
03-03-11-01

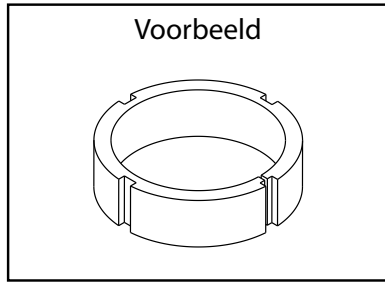

Gegevens klant

Type machine:

Prijsaanvraag

Serienr. machine:

Bestelling

CODE: TY-R x TY-F x LO-R x TY-LO x QTY-HO x QTY-AGR x TY-AGR x QTY-RGR x TY-RGR x
QTY-NOT x TY-NOT x QTY-CFE x QTY-CFI x MI x D1 x D2 x D3 x D4 x H1 x H2 x D5 x D6 x
D7 x D8 x H3 x H4 x MAT

TY-R..... Type geleidingsring.

TY-F..... Vorm van de geleidingsring:

A = volledig rond

B = half rond

C = gedeeltelijk rond

LO-R Sluiting van de geleidingsring:

C = gesloten

O = open

TY-LO Type sluiting.

QTY-HO Aantal gaten.

QTY-AGR..... Aantal axiale groeven.

TY-AGR..... Type axiale groeven, combinaties mogelijk.

QTY-RGR Aantal radiale groeven.

TY-RGR..... Type radiale groeven, combinaties mogelijk.

QTY-NOT..... Aantal inkepingen.

TY-NOT..... Type inkepingen.

QTY-CFE..... Aantal uitwendige afschuiningen/af rondingen.

QTY-CFI Aantal inwendige afschuiningen/af rondingen.

MI..... Maateenheid:

M = metrisch

I = inch

zie Engelse technische fiche !



TECHNICAL DETAIL: GUIDE RING

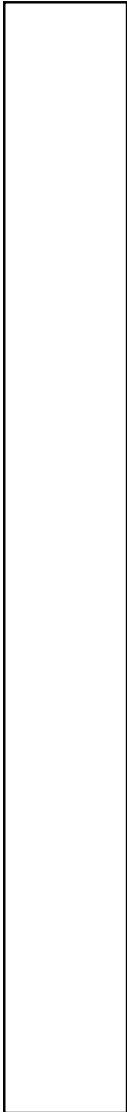

- D1 Grootste buitendiameter (mm).
- D2 Kleinste buitendiameter (mm).
- D3 Grootste binnendiameter (mm).
- D4 Kleinste binnendiameter (mm).
- H1 Grootste hoogte (mm).
- H2 Kleinste hoogte (mm).
- D5 Grootste buitendiameter (inch).
- D6 Kleinste buitendiameter (inch).
- D7 Grootste binnendiameter (inch).
- D8 Kleinste binnendiameter (inch).
- H3 Grootste hoogte (inch).
- H4 Kleinste hoogte (inch).
- MAT..... Materiaal:
 - EP = epratex*
 - PA = polyamide/acetaalhars*
 - PB = polytetrafluoretheen met brons*
 - PC = polycarbonaat*
 - POM = polyoxymethyleen*
 - PTFE = polytetrafluoethyleen*
 - PU = polyurethaan*
 - RP = fenolhars*

zie Engelse technische fiche !



TECHNICAL DETAIL: GUIDE RING

Groupe
03-03-11-01

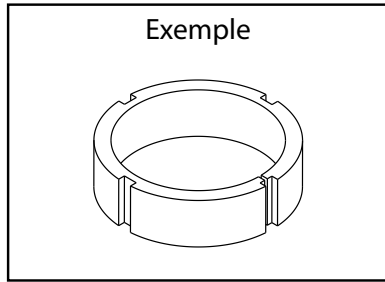

Données client

Type machine :

Demande de prix

No. série machine :

Commande

CODE : TY-R x TY-F x LO-R x TY-LO x QTY-HO x QTY-AGR x TY-AGR x QTY-RGR x TY-RGR x
QTY-NOT x TY-NOT x QTY-CFE x QTY-CFI x MI x D1 x D2 x D3 x D4 x H1 x H2 x D5 x D6 x
D7 x D8 x H3 x H4 x MAT

TY-R..... Type de la bague de guidage.

TY-F..... Forme de la bague de guidage :

A = complètement ronde

B = demi-ronde

C = partiellement ronde

LO-R Fermeture de la bague de guidage :

C = fermée

O = ouverte

TY-LO Type de fermeture.

QTY-HO Nombre de trous.

QTY-AGR..... Nombre de rainures axiales.

TY-AGR..... Type de rainures axiales, combinaisons possible.

QTY-RGR Nombre de rainures radiales.

TY-RGR..... Type de rainures radiales, combinaisons possibles.

QTY-NOT..... Nombre d'encoches.

TY-NOT..... Type d'encoches.

QTY-CFE..... Nombre de chanfreins/arrondis extérieurs.

QTY-CFI Nombre de chanfreins/arrondis intérieurs.

MI..... Unité de mesure :

M = métrique

I = pouce

voir la fiche technique en Anglais.



TECHNICAL DETAIL: GUIDE RING

- D1 Plus grand diamètre extérieur (mm).
D2 Plus petit diamètre extérieur (mm).
D3 Plus grand diamètre intérieur (mm).
D4 Plus petit diamètre intérieur (mm).
H1 Plus grande hauteur (mm).
H2 Plus petite hauteur (mm).
D5 Plus grand diamètre extérieur (pouce).
D6 Plus petit diamètre extérieur (pouce).
D7 Plus grand diamètre intérieur (pouce).
D8 Plus petit diamètre intérieur (pouce).
H3 Plus grande hauteur (pouce).
H4 Plus petite hauteur (pouce).
MAT..... Matériel :
 EP = epratex
 PA = résine acétale
 PB = polytétrafluoroéthylène avec bronze
 PC = polycarbonate
 POM = polyoxyméthylène
 PTFE = polytétrafluoroéthylène
 PU = polyuréthane
 RP = résine phénolique

[voir la fiche technique en Anglais.](#)



TECHNICAL DETAIL: GUIDE RING

Gruppe
03-03-11-01

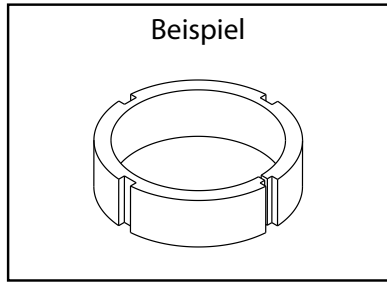

Kundendaten

Maschinentyp:

Preis Anfrage

Serien-Nr. Maschine:

Bestellung

CODE: TY-R x TY-F x LO-R x TY-LO x QTY-HO x QTY-AGR x TY-AGR x QTY-RGR x TY-RGR x
QTY-NOT x TY-NOT x QTY-CFE x QTY-CFI x MI x D1 x D2 x D3 x D4 x H1 x H2 x D5 x D6 x
D7 x D8 x H3 x H4 x MAT

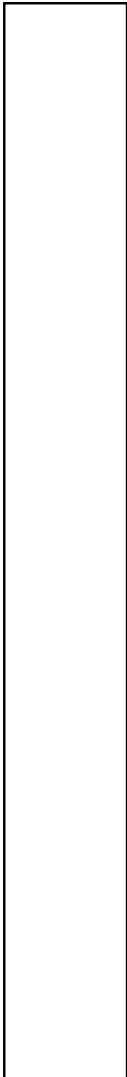

- TY-R..... Art des Führungsrings.
- TY-F..... Form des Führungsrings:
A = *Komplett rund*
B = *Halbrund*
C = *Teilweise rund*
- LO-R Verriegelung des Führungsrings:
C = *Geschlossen*
O = *Offen*
- TY-LO Art der Verriegelung.
- QTY-HO Anzahl der Löcher.
- QTY-AGR..... Anzahl der Axialnuten.
- TY-AGR..... Art der Axialnuten, Kombinationen möglich.
- QTY-RGR Anzahl der Radialnuten.
- TY-RGR..... Art der Radialnuten, Kombinationen möglich.
- QTY-NOT..... Anzahl der Aussparungen.
- TY-NOT..... Art der Aussparungen.
- QTY-CFE..... Anzahl der äußeren Abschrägungen/Abrundungen.
- QTY-CFI Anzahl der inneren Abschrägungen/Abrundungen.
- MI..... Maßeinheit:
M = *Metrisch*
I = *Zoll*

Siehe technische Datenblätter auf Englisch.



TECHNICAL DETAIL: GUIDE RING

- D1 Größter Außendurchmesser (mm).
- D2 Kleinster Außendurchmesser (mm).
- D3 Größter Innendurchmesser (mm).
- D4 Kleinster Innendurchmesser (mm).
- H1 Maximalhöhe (mm).
- H2 Minimalhöhe (mm).
- D5 Größter Außendurchmesser (Zoll).
- D6 Kleinster Außendurchmesser (Zoll).
- D7 Größter Innendurchmesser (Zoll).
- D8 Kleinster Innendurchmesser (Zoll).
- H3 Maximalhöhe (Zoll).
- H4 Minimalhöhe (Zoll).
- MAT..... Material:
 - EP = Epratex*
 - PA = Polyamid*
 - PB = Polytetrafluorethylen mit Bronze*
 - PC = Polycarbonat*
 - POM = Polyoxymethylen*
 - PTFE = Polytetrafluoethylen*
 - PU = Polyurethan*
 - RP = Phenolharz*

Siehe technische Datenblätter auf Englisch.



BACK-UP RING

BACK-UP RING

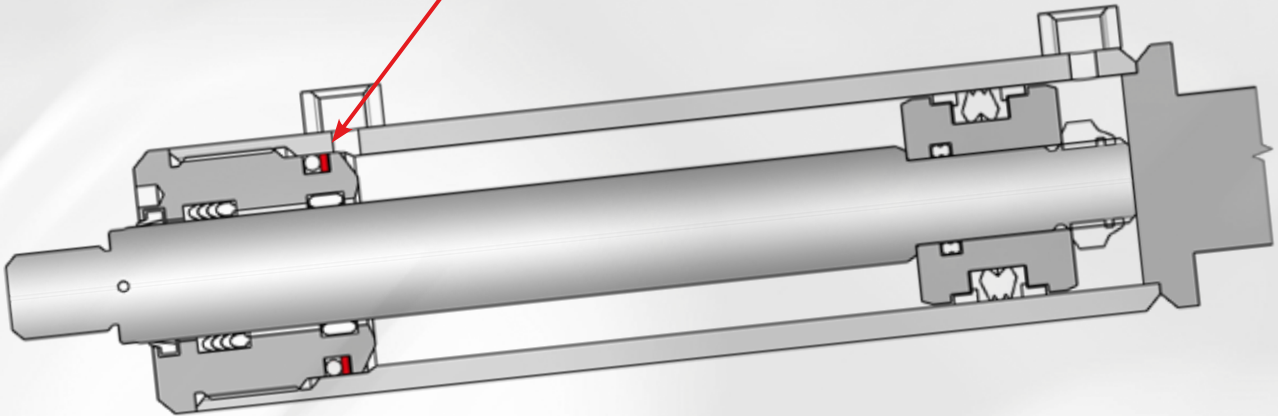

BACKUP RING

D2

[Reset](#)

Refine search

Outer diameter D2 (mm):

[New](#) [Tolerances](#)

Search results

TVHNumber	TY-BU	TY-OC	D1	D2	H1	MAT
22236959	BU02	Closed	30	40	3	bronze + polytetrafluorethene
22835487	BU04	Open	30	35	2	bronze + polytetrafluorethene

MyProductSearch: Use technical details or specifications to find your necessary parts.
 No part number, no brand, no type of truck?
 Identify your parts by means of specifications or technical info.





TECHNICAL DETAIL: BACK-UP RING

Group
03-03-10-00

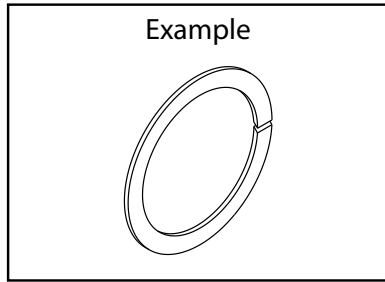

Customer details

Type machine:

Price inquiry

Serial n° machine:

Order

CODE: TY-BU x TY-OC x D1 x D2 x H1 x D3 x S x MAT

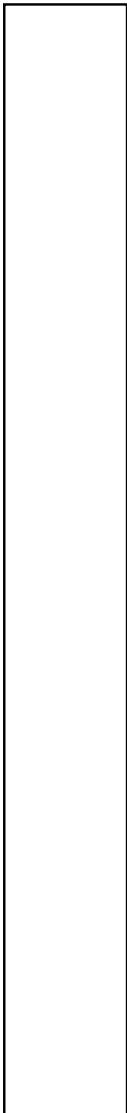

- TY-BU Type of the back-up ring.
- TY-OC Open or closed back-up ring:
 - O = open*
 - C = closed*
- D1 Inner diameter (mm).
- D2 Outer diameter (mm).
- H1 Height of the back-up ring (mm).
- D3 Inner diameter of the associated O-ring (mm).
- S Diameter of the cross-section of the O-ring (mm).
- MAT Material:
 - NBR = rubber (black)*
 - PTFE = polytetrafluorethene (white, nontransparent)*
 - PU = polyurethane (blue, green, red, yellow)*
 - PA = polyamide (nylon)*
 - PB = bronze + polytetrafluorethene*
 - PC = graphite + polytetrafluorethene*
 - EPDM = ethylene propylene diene monomer = synthetic rubber*
 - POL = reinforced polyester (off-white)*



TECHNICAL DETAIL: BACK-UP RING

TY-BU: TYPE OF THE BACK-UP RING

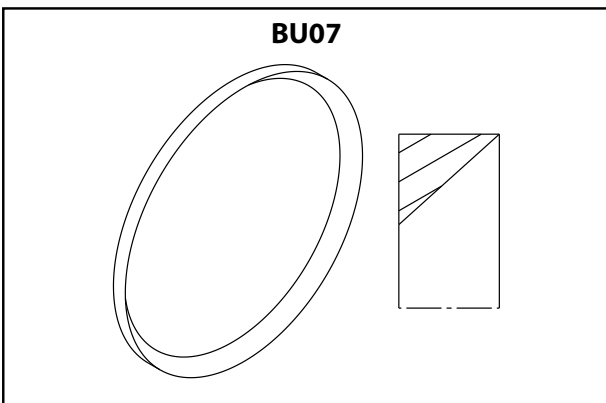
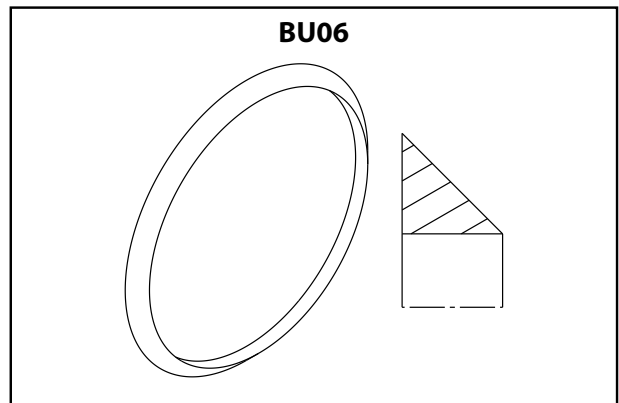
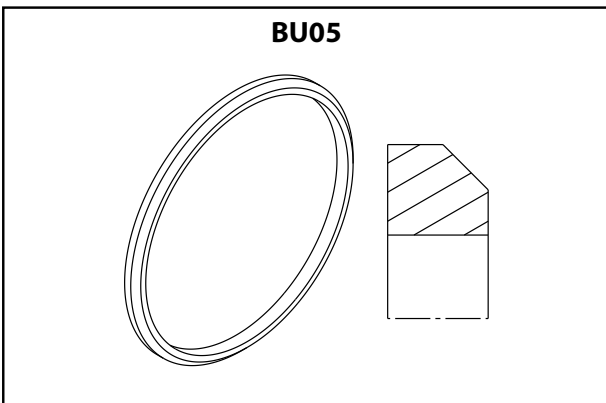
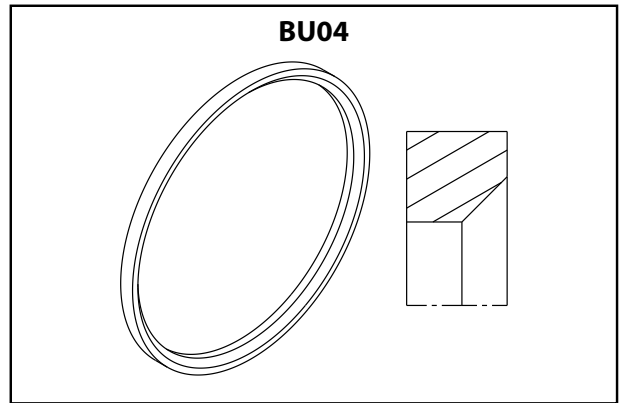
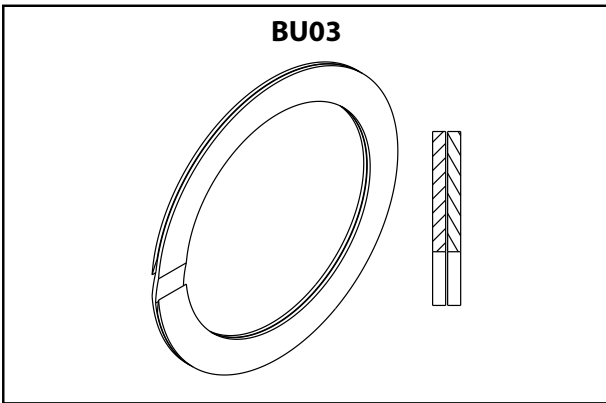
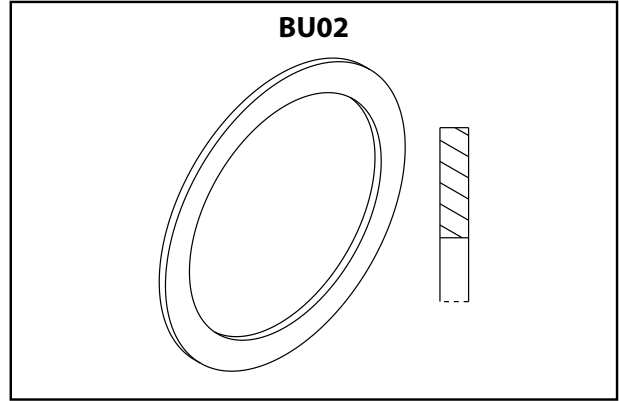
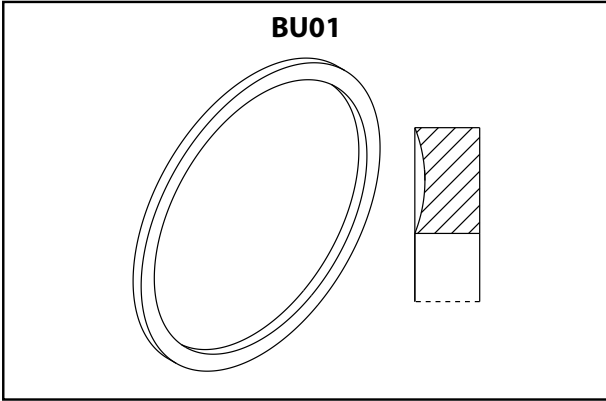



TECHNICAL DETAIL: BACK-UP RING

TY-OC: OPEN OR CLOSED BACK-UP RING

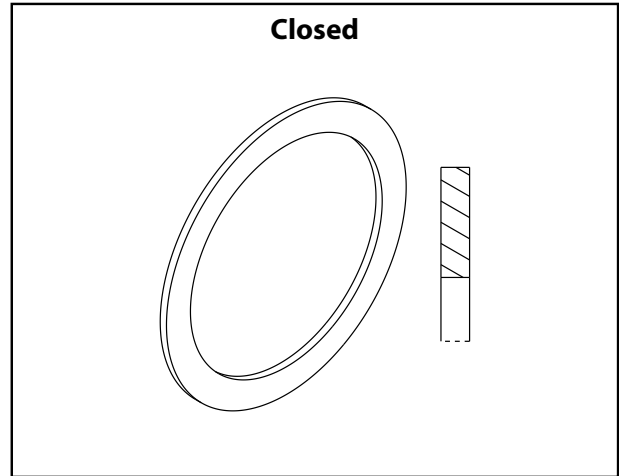
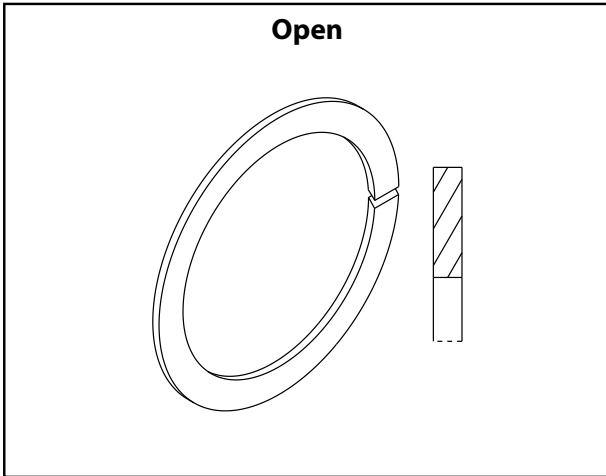

DIMENSIONS

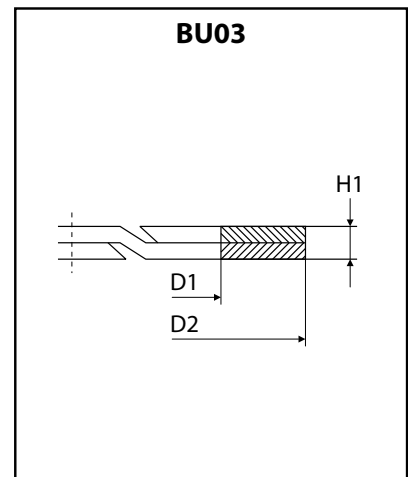
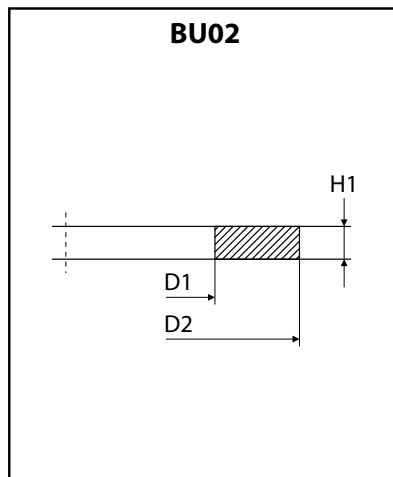
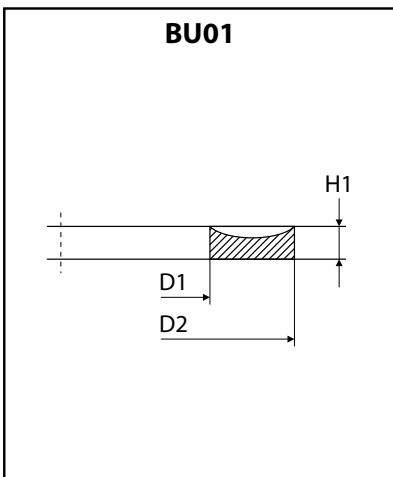



TECHNICAL DETAIL: BACK-UP RING

Groep
03-03-10-00

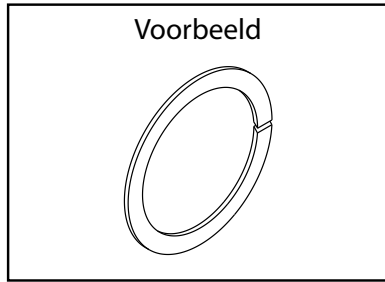

Gegevens klant

Type machine:

Prijsaanvraag

Serienr. machine:

Bestelling

CODE: TY-BU x TY-OC x D1 x D2 x H1 x D3 x S x MAT

TY-BU Type van de back-up ring.

TY-OC Open of gesloten back-up ring:

O = open

C = gesloten

D1 Binnendiameter (mm).

D2 Buitendiameter (mm).

H1 Hoogte van de back-up ring (mm).

D3 Binnendiameter van de overeenkomstige O-ring (mm).

S Diameter van de doorsnede van de O-ring (mm).

MAT Materiaal:

NBR = rubber (zwart)

PTFE = polytetrafluoretheen (wit, niet transparant)

PU = polyurethaan (blauw, groen, rood, geel)

PA = polyamide (nylon)

PB = brons + polytetrafluoretheen

PC = grafiet + polytetrafluoretheen

EPDM = ethyleen propyleen diene monomeer = synthetisch rubber

POL = versterkte polyester (gebroken wit)

zie Engelse technische fiche !



TECHNICAL DETAIL: BACK-UP RING

Groupe
03-03-10-00

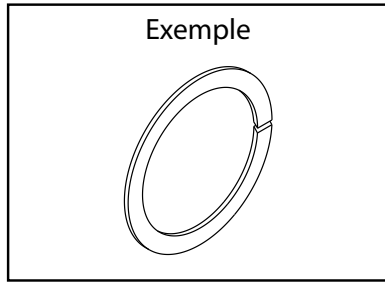

Données client

Type machine :

Demande de prix

No. série machine :

Commande

CODE : TY-BU x TY-OC x D1 x D2 x H1 x D3 x S x MAT

TY-BU Type de la bague anti-extrusion.

TY-OC Bague anti-extrusion ouverte ou fermée :

O = ouvert

C = fermé

D1 Diamètre intérieur (mm).

D2 Diamètre extérieur (mm).

H1 Hauteur de la bague anti-extrusion (mm).

D3 Diamètre intérieur du joint torique correspondant (mm).

S Diamètre de la section transversale du joint torique (mm).

MAT Matériel :

NBR = caoutchouc (noir)

PTFE = polytétrafluoroéthène (blanc, non transparent)

PU = polyuréthane (bleu, vert, rouge, jaune)

PA = polyamide (nylon)

PB = bronze + polytétrafluoroéthène

PC = graphite + polytétrafluoroéthène

EPDM = éthylène-propylène-diène monomère = caoutchouc synthétique

POL = polyester renforcé (blanc cassé)

voir la fiche technique en Anglais.



TECHNICAL DETAIL: BACK-UP RING

Gruppe
03-03-10-00

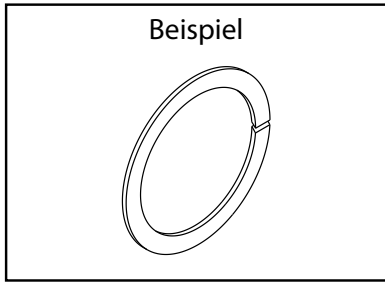

Kundendaten

Maschinentyp:

Preis Anfrage

Serien-Nr. Maschine:

Bestellung

CODE: TY-BU x TY-OC x D1 x D2 x H1 x D3 x S x MAT

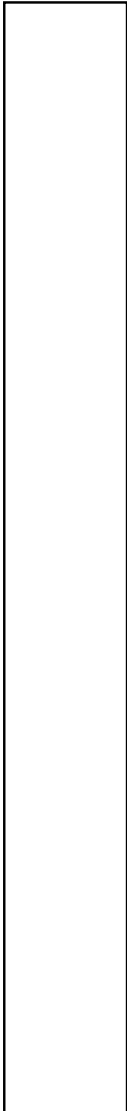

TY-BU Typ vom Stützring.

TY-OC Offen oder geschlossener Stützring:

O = offen

C = geschlossen

D1 Innendurchmesser (mm).

D2 Aussendurchmesser (mm).

H1 Höhe des Stützrings (mm).

D3 Innendurchmesser des entsprechenden O-Ring (mm).

S Durchmesser des Querschnitts des O-Rings (mm).

MAT Material:

NBR = Gummi (schwarz)

PTFE = Polytetrafluorethylen (weiß, nicht transparent)

PU = Polyurethan (blau, grün, rot, gelb)

PA = Polyamid (Nylon)

PB = Bronze + Polytetrafluorethylen

PC = Graphit + Polytetrafluorethylen

EPDM = Ethylen-Propylen-Dien-Monomer = synthetischer Kautschuk

POL = verstärktem Polyester (weiß)

Siehe technische Datenblätter auf Englisch.



V-RING

V-RING

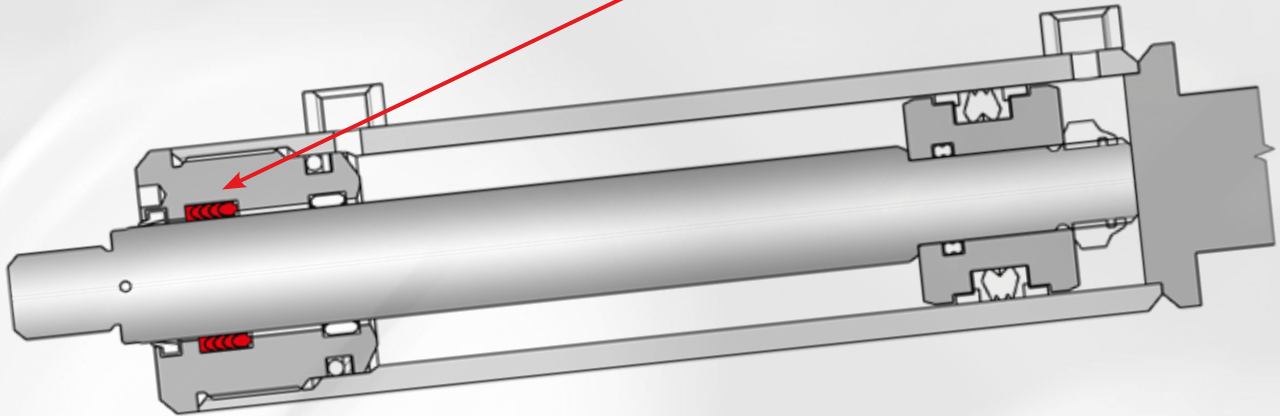

V-RING



Reset

Refine search

Outer diameter D2 (mm):

Next Tolerances

Search results

TVISNumber	TY	D1	D2	H1	MAT	D3	D4	H2
1294522	€ VA	29	37	7.5	Rubber	1.14	1.46	0.3
1971675	€ VS	29	37	10.5	Rubber	1.14	1.46	0.41

MyProductSearch: Use technical details or specifications to find your necessary parts.
 No part number, no brand, no type of truck?
 Identify your parts by means of specifications or technical info.





TECHNICAL DETAIL: V-RING

Group
03-03-18-00



Customer details

Type machine:

Price inquiry

Serial n° machine:

Order

CODE: TY x MI x D1 x D2 x H1 x MAT x D3 x D4 x H2

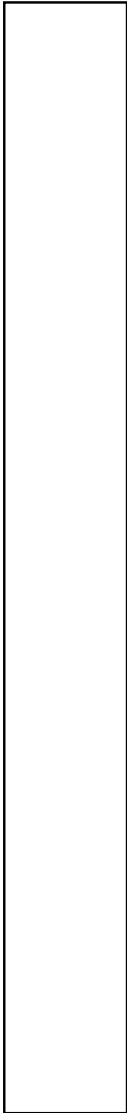

- TY..... Type of the V-ring.
- MI..... Unit of measurement:
 - M = metric*
 - I = imperial (non metric)*
- D1 Inner diameter (mm).
- D2 Outer diameter (mm).
- H1 Height (mm).
- MAT..... Material:
 - NBR = rubber*
 - FKM = viton*
 - PU = polyurethane*
- D3 Inner diameter (inch).
- D4 Outer diameter (inch).
- H2 Height (inch).



TECHNICAL DETAIL: V-RING

TY: TYPES

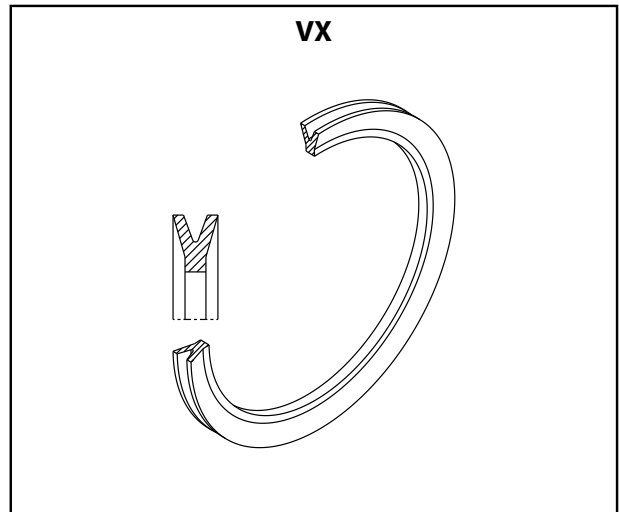
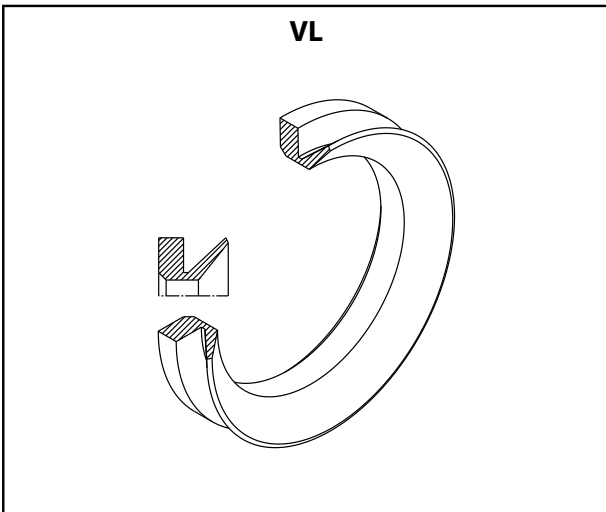
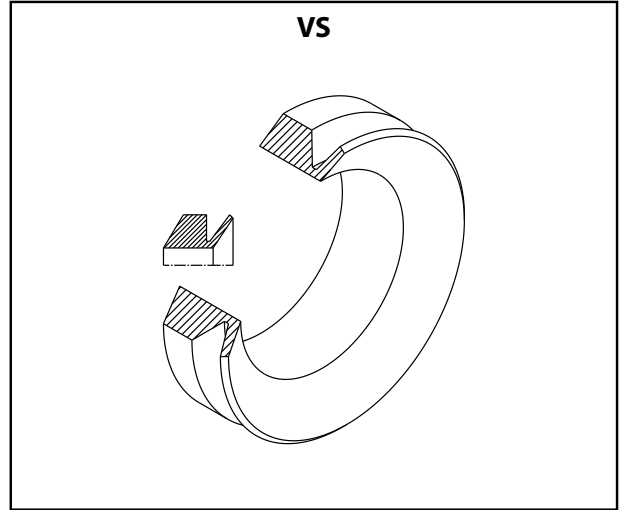
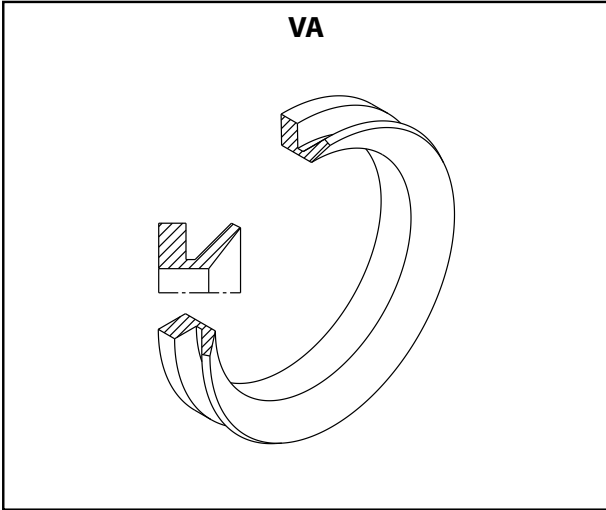

DIMENSIONS

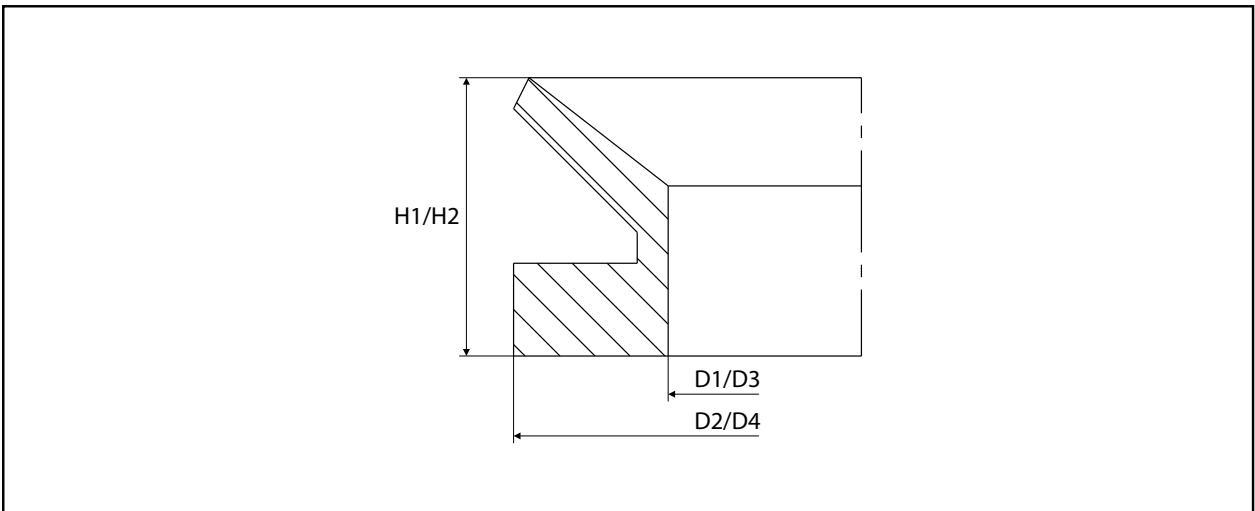



TECHNICAL DETAIL: V-RING

Groep
03-03-18-00



Gegevens klant

Type machine:
 Serienr. machine:

Prijsaanvraag
 Bestelling

CODE: TY x MI x D1 x D2 x H1 x MAT x D3 x D4 x H2



- TY..... Type van de V-ring.
- MI..... Eenheid:
 M = metrisch
 I = imperial (niet-metrisch)
- D1 Binnendiameter (mm).
- D2 Buitendiameter (mm).
- H1 Hoogte (mm).
- MAT..... Materiaal:
 NBR = rubber
 FKM = viton
 PU = polyurethaan
- D3 Binnendiameter (duim).
- D4 Buitendiameter (duim).
- H2 Hoogte (duim).

zie Engelse technische fiche !



TECHNICAL DETAIL: V-RING

Groupe
03-03-18-00



Données client

Type machine :
No. série machine :

Demande de prix
Commande

CODE : TY x MI x D1 x D2 x H1 x MAT x D3 x D4 x H2



- TY..... Type de joint en V.
- MI..... Unité :
 - M = métrique*
 - I = imperial (pas métrique)*
- D1 Diamètre intérieur (mm).
- D2 Diamètre extérieur (mm).
- H1 Hauteur (mm).
- MAT..... Matériel :
 - NBR = caoutchouc*
 - FKM = viton*
 - PU = polyuréthane*
- D3 Diamètre intérieur (pouce).
- D4 Diamètre extérieur (pouce).
- H2 Hauteur (pouce).

voir la fiche technique en Anglais.



TECHNICAL DETAIL: V-RING

Gruppe
03-03-18-00



Kundendaten

Maschinentyp:

Preis Anfrage

Serien-Nr. Maschine:

Bestellung

CODE: TY x MI x D1 x D2 x H1 x MAT x D3 x D4 x H2



- TY..... Type der V-ring.
- MI..... Einheit:
 - M = Metrish*
 - I = Imperial (keine metrischen)*
- D1 Innerdurchmesser (mm).
- D2 Außendurchmesser (mm).
- H1 Höhe (mm).
- MAT..... Material:
 - NBR = Gummi*
 - FKM = Fluorkohlenstoffgummi*
 - PU = Polyurethan*
- D3 Innerdurchmesser (inch).
- D4 Außendurchmesser (inch).
- H2 Höhe (inch).

Siehe technische Datenblätter auf Englisch.



BONDED SEAL

BONDED SEAL

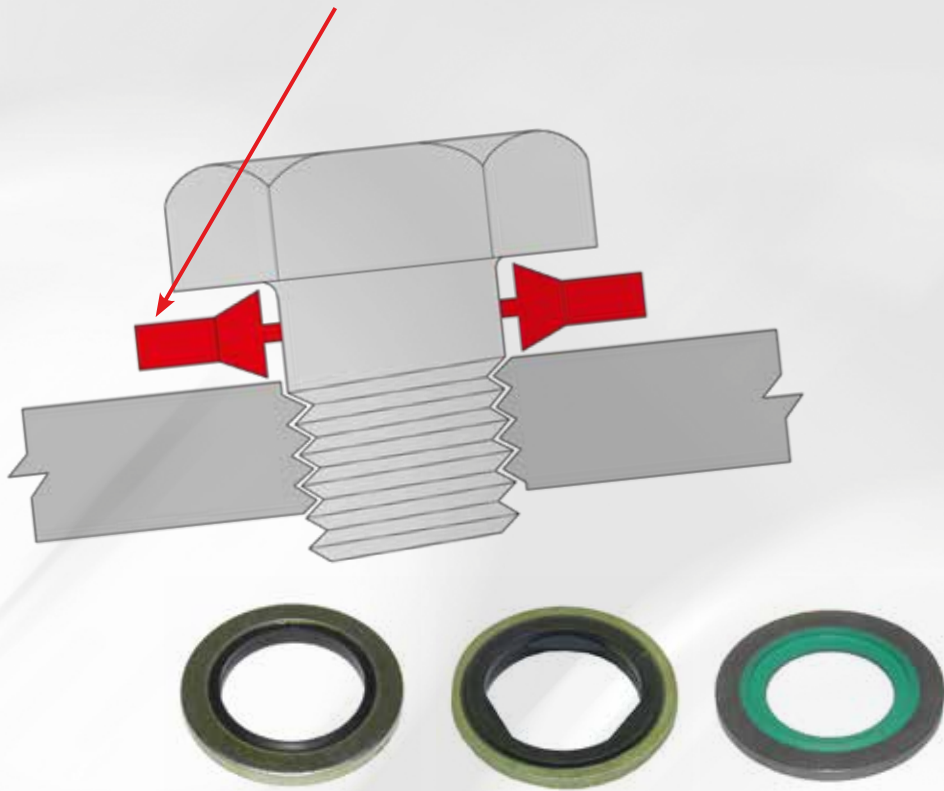

BONDED SEAL

Reset

Refine search

Type bonded seal

Search results

TVHNumber	TY	D1	D2	H1	TA1	MAT1	MAT2
3594994	€ S1	30	38	1.6		NBR	steel
14697781	€ S1	29.8	38	1.5 1/8		NBR	steel
50564913	€ BS9	30.5	43	2.5		NBR	steel
7865907	€ BS	30.7	39	2 M30		NBR	steel
3539598	€ S1	31	39	2		NBR	steel

MyProductSearch: Use technical details or specifications to find your necessary parts.
 No part number, no brand, no type of truck?
 Identify your parts by means of specifications or technical info.





TECHNICAL DETAIL: BONDED SEAL

Group
03-03-19-00



Customer details

Type machine:

Price inquiry

Serial n° machine:

Order

CODE: TY x D1 x D2 x H1 x TA1 x TA2 x MAT1 x MAT2

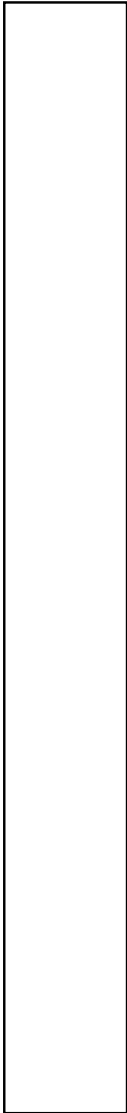

- TY..... Type of bonded seal (see drawings).
- D1 Inner diameter (mm).
- D2 Outer diameter (mm).
- H1 Height outer ring (mm).
- TA1 Used for thread type (smallest) (M16, 3/8" UNF, ...).
- TA2 Used for thread type if BSP (biggest) (M16, 3/8" UNF, ...).
- MAT1 Material inner ring:
 - NBR = rubber*
 - FKM = viton*
- MAT2 Material outer ring:
 - ALU = aluminium*
 - ST = steel*
 - SS = stainless steel*



TECHNICAL DETAIL: BONDED SEAL

TYPES

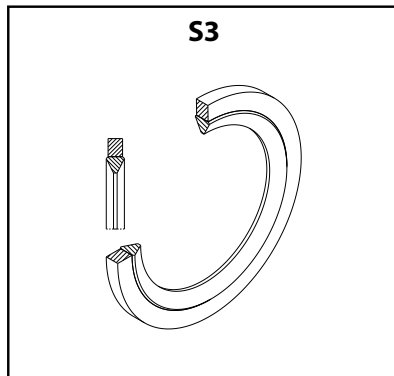
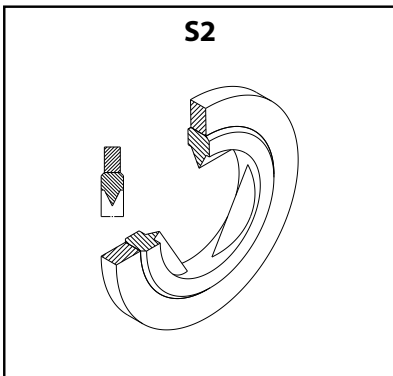
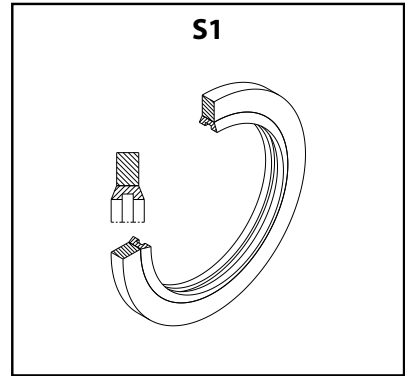
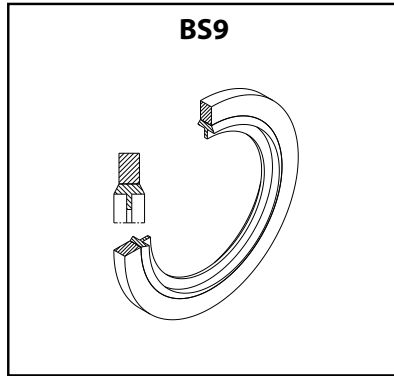
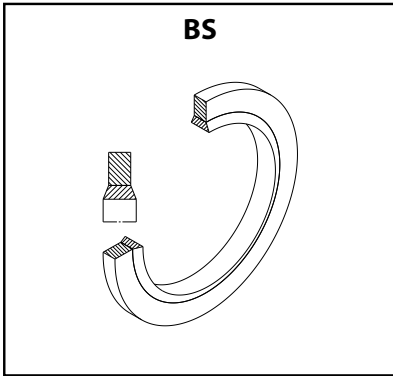

DIMENSIONS

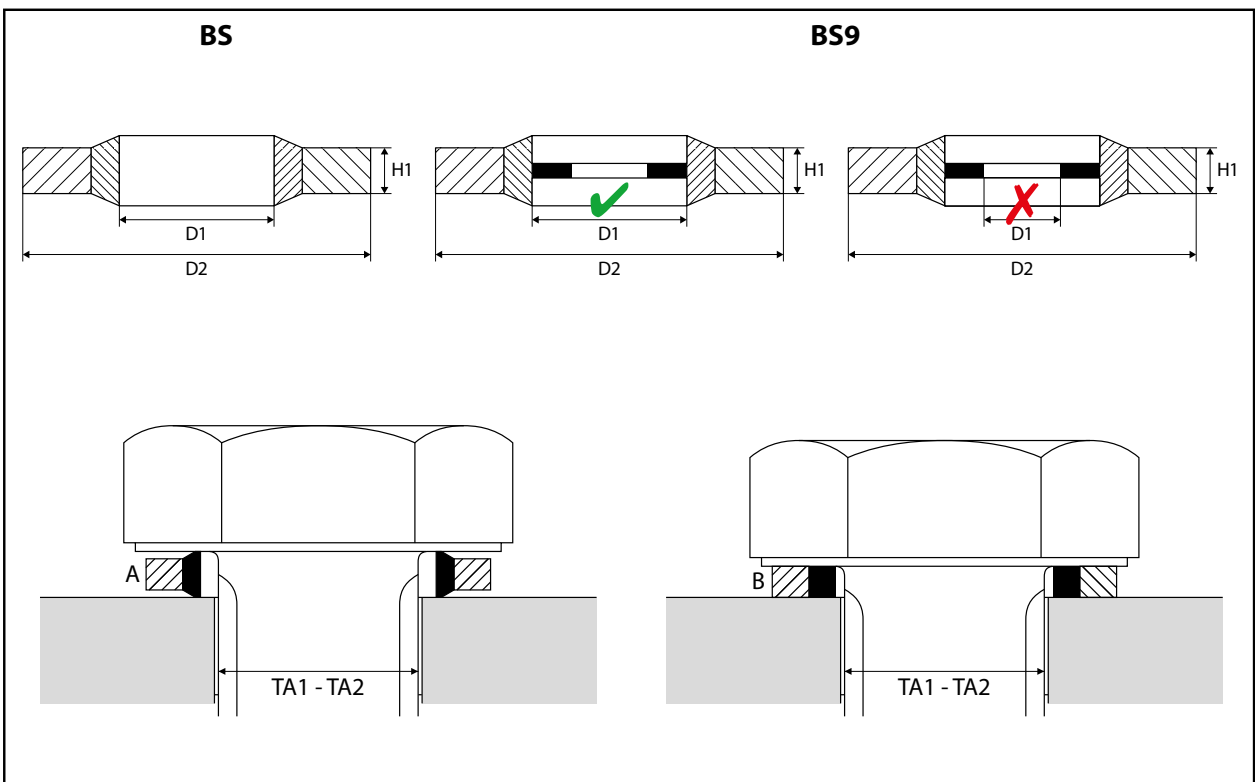



TECHNICAL DETAIL: BONDED SEAL

Groep
03-03-19-00



Gegevens klant

Type machine:

Prijsaanvraag

Serienr. machine:

Bestelling

CODE: TY x D1 x D2 x H1 x TA1 x TA2 x MAT1 x MAT2

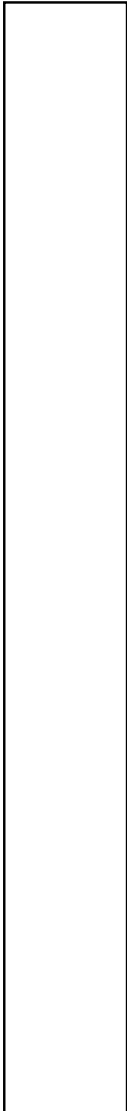

TY..... Type multi seal (zie tekeningen).

D1 Binnendiameter (mm).

D2 Buitendiameter (mm).

H1 Hoogte buitenste ring (mm).

TA1 Gebruikt voor draadsoort (kleinste) (M16, 3/8" UNF, ...).

TA2 Gebruikt voor draadsoort indien BSP (grootste) (M16, 3/8" UNF, ...).

MAT1 Materiaal binnenring:

NBR = rubber

FKM = viton

MAT2 Materiaal buitenring:

ALU = aluminium

ST = staal

SS = roestvrij staal

zie Engelse technische fiche !



TECHNICAL DETAIL: BONDED SEAL

Groupe
03-03-19-00



Données client

Type machine :

Demande de prix

No. série machine :

Commande

CODE : TY x D1 x D2 x H1 x TA1 x TA2 x MAT1 x MAT2



- TY..... Type de bague composite (voir dessins).
- D1 Diamètre intérieur (mm).
- D2 Diamètre extérieur (mm).
- H1 Hauteur de la bague extérieure (mm).
- TA1 Utilisée pour type de filetage (inférieur) (M16, 3/8" UNF, ...).
- TA2 Utilisée pour type de filetage (supérieur) (M16, 3/8" UNF, ...).
- MAT1 Matériel bague intérieure :
 - NBR = caoutchouc
 - FKM = viton
- MAT2 Matériel bague extérieure :
 - ALU = aluminium
 - ST = acier
 - SS = acier inoxydable

voir la fiche technique en Anglais.



TECHNICAL DETAIL: BONDED SEAL

Gruppe
03-03-19-00



Kundendaten

Maschinentyp:

Preis-anfrage

Serien-Nr. Maschine:

Bestellung

CODE: TY x D1 x D2 x H1 x TA1 x TA2 x MAT1 x MAT2

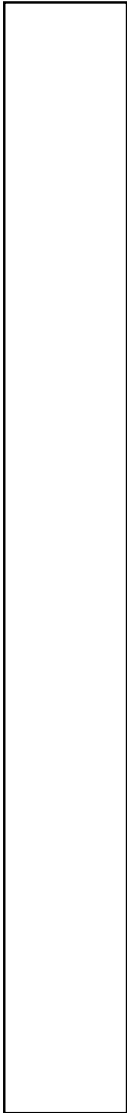

TY..... Art der Verbunddichtung (siehe Zeichnung).

D1 Innendurchmesser (mm).

D2 Aussendurchmesser (mm).

H1 Höhe Aussenring (M16, 3/8" UNF, ...).

TA1 Geeignet für Gewindeart (kleinste) (M16, 3/8" UNF, ...).

TA2 Geeignet für Gewindeart wenn BSP (größte).

MAT1 Material Innenring:

NBR = Gummi

FKM = Viton

MAT2 Material Aussenring:

ALU = Aluminium

ST = Stahl

SS = Edelstahl

Siehe technische Datenblätter auf Englisch.



OIL SEAL

OIL SEAL

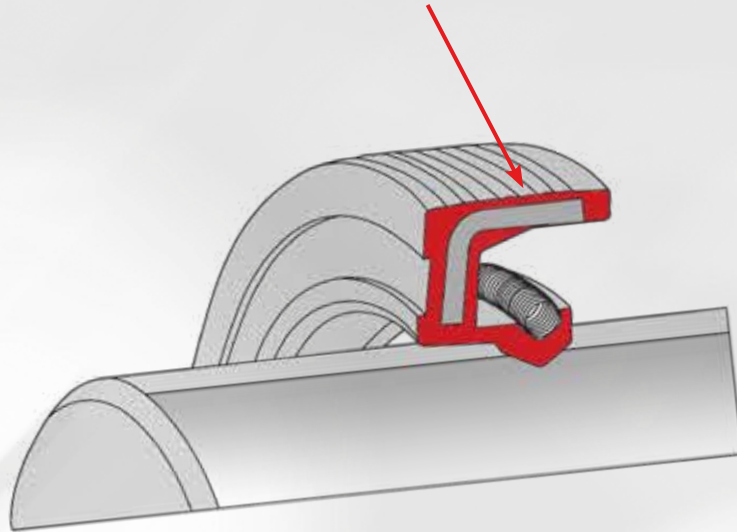

OIL SEAL



Reset

Refine search

Inner diameter D2 (mm):

Next Tolerances

Search results

TVNumber	TY	VE	MI	D1	D2	HI	D3	D4	H3	MAT	DR	AT-GA	GLV
14719650	€	510	3A	M	30	20	7			RUBBER	Z-NO ROTATION		YES
19988650	€	505	3A	M	30	18	7			RUBBER	Z-NO ROTATION		NO
18256824	€	505	3A	M	30	18	7			Laminat	Z-NO ROTATION		NO

MyProductSearch: Use technical details or specifications to find your necessary parts.
 No part number, no brand, no type of truck?
 Identify your parts by means of specifications or technical info.





TECHNICAL DETAIL: OIL SEAL

Group
03-03-02-00



Customer details

Type machine:
Serial n° machine:

Price inquiry
Order

CODE: TY x VE x MI x D1 x D2 x H1 x D3 x D4 x H3 x MAT x DR x AT-GA x GLV

[Empty box for notes or additional information]

- TY..... Type of oil seal.
- VE..... Spring present: YES/NO/DOUBLE.
- MI..... Unit:
 - M = metric*
 - I = inch*
- D1 Outer diameter (mm).
- D2 Inner diameter (mm).
- H1 Height (mm).
- D3 Outer diameter (inch).
- D4 Inner diameter (inch).
- H3 Height (inch).
- MAT..... Material:
 - AL = aluminium*
 - F = felt*
 - KS = plastic*
 - LE = leather*
 - M = metal*
 - MB = metal armoured*
 - NY = nylon*
 - PTFE = teflon*
 - PTFEB = teflon – bronze*
 - PU = polyurethane*
 - R = rubber*
 - S = silicone*
 - V = viton*
 - ACM = acrylic rubber*



TECHNICAL DETAIL: OIL SEAL

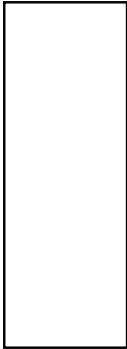

DR Direction of rotation:
R = right – hand rotation
L = left – hand rotation
W = left – hand and right – hand rotation
Z = no direction of rotation

AT-GA..... Number of holes.

GLV Wave: YES/NO (see figure).

DIMENSIONS

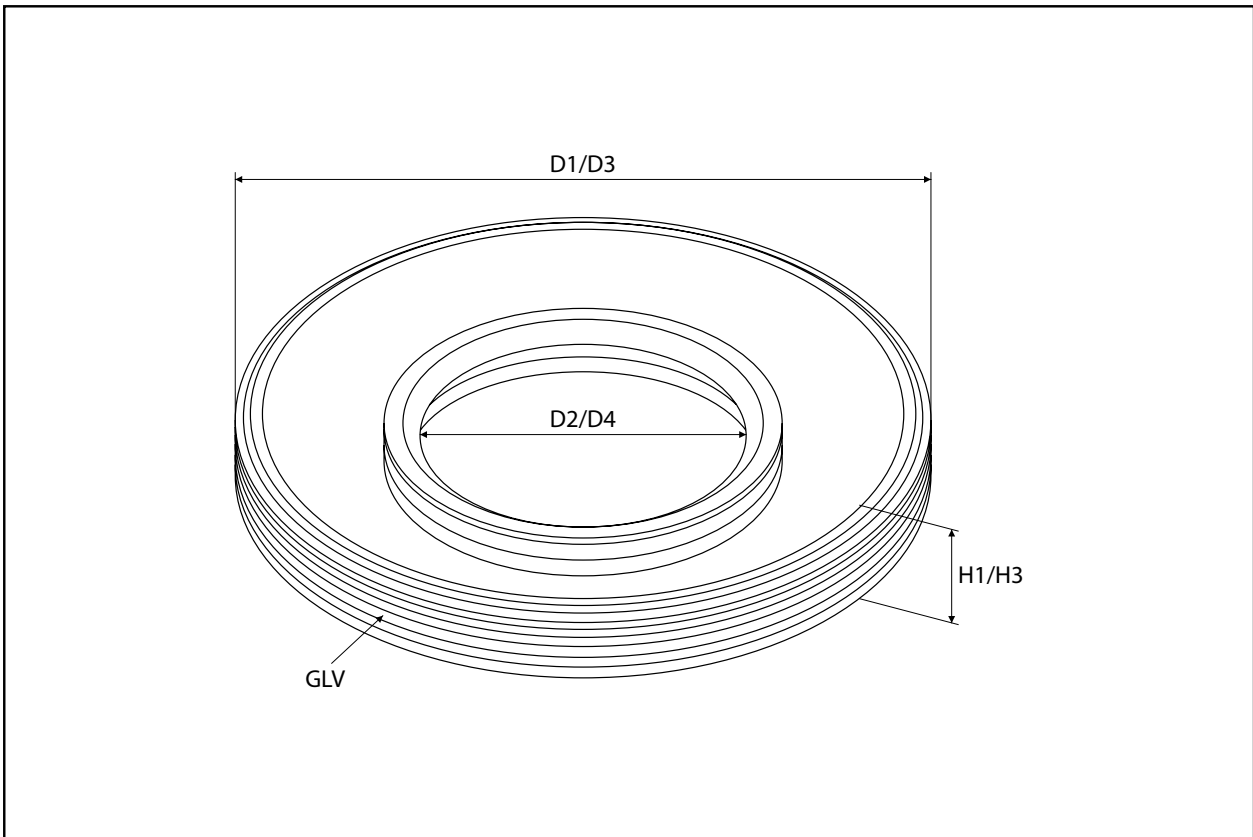



TECHNICAL DETAIL: OIL SEAL

TYPES

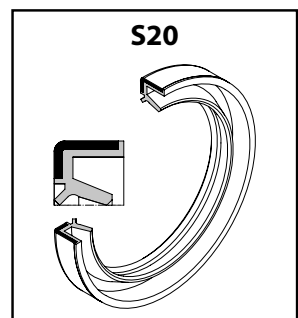
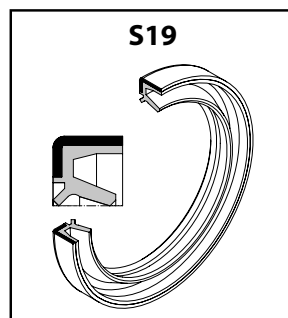
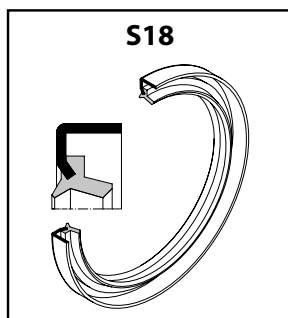
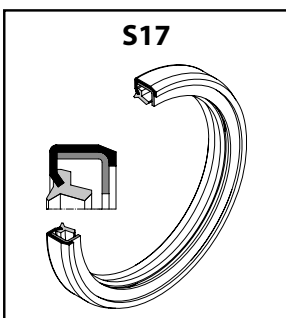
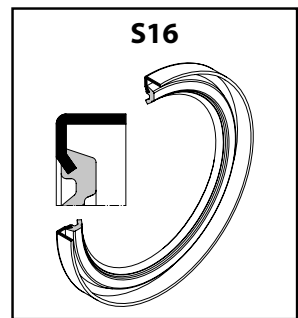
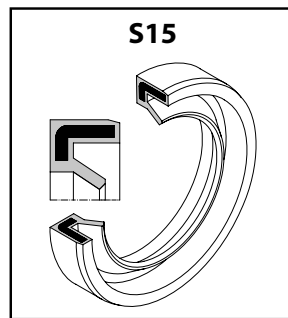
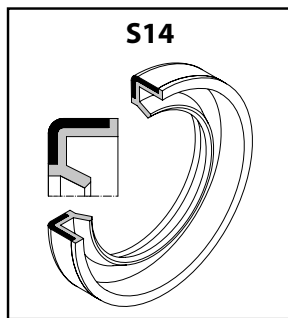
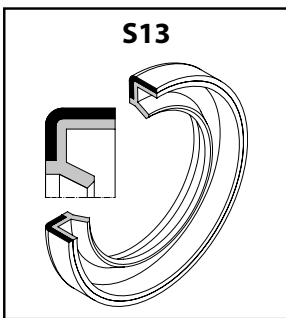
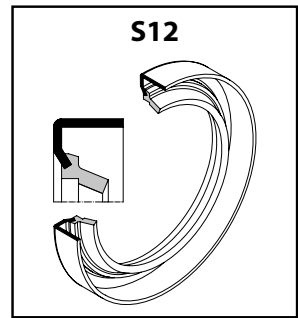
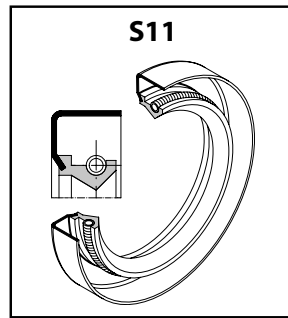
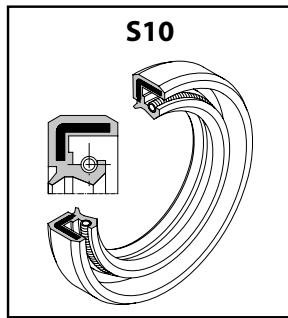
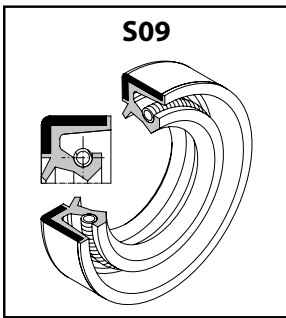
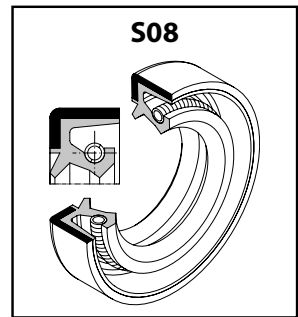
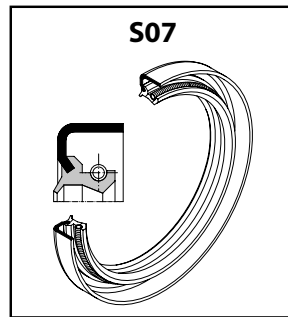
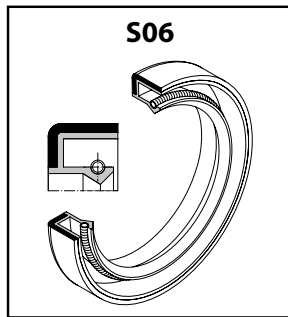
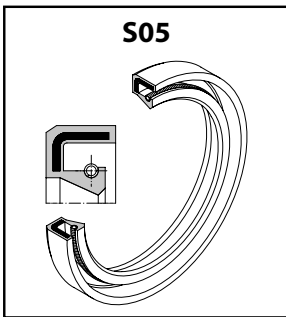
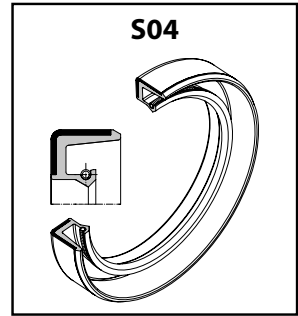
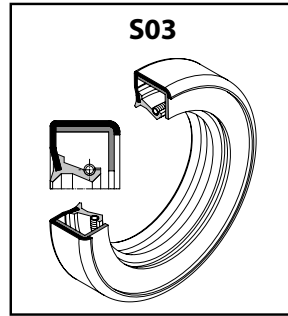
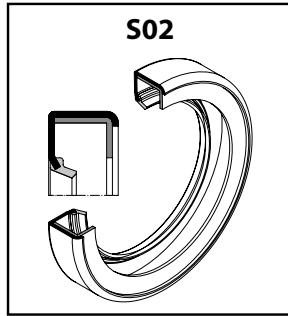
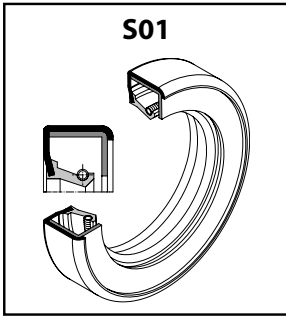



TECHNICAL DETAIL: OIL SEAL

TYPES

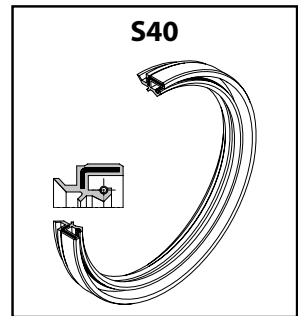
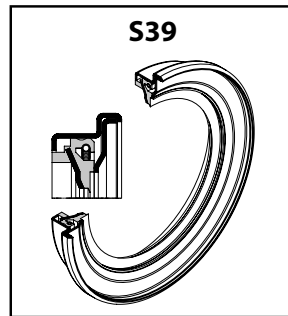
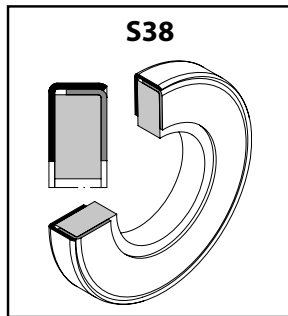
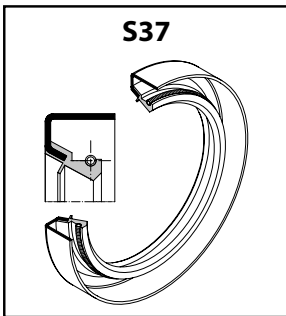
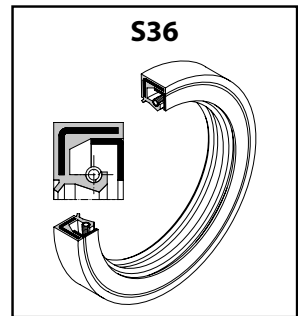
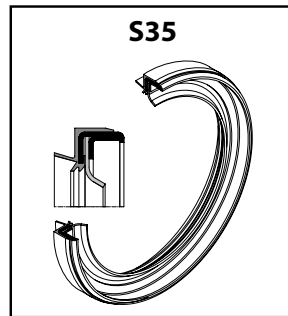
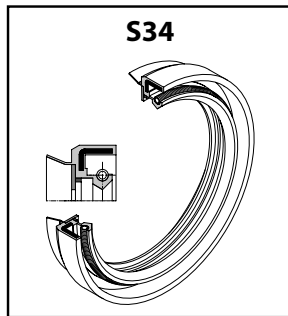
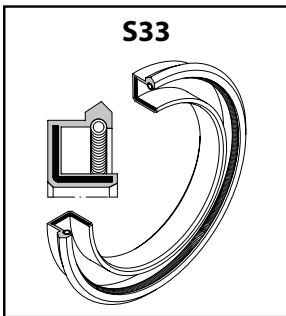
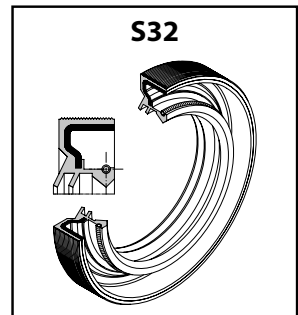
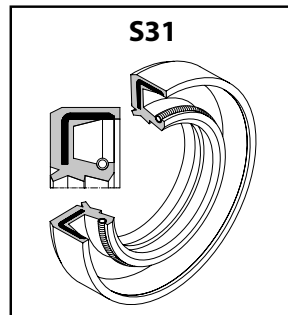
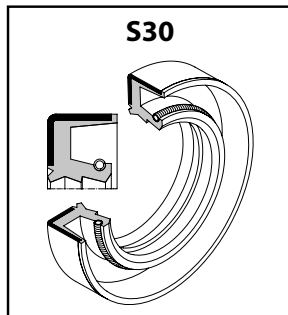
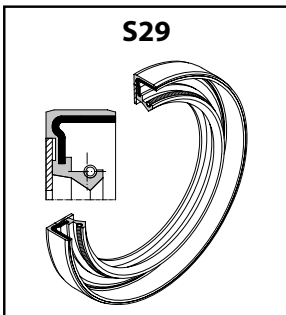
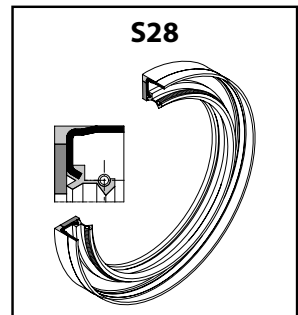
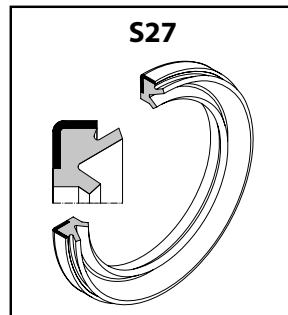
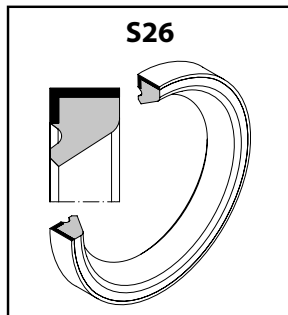
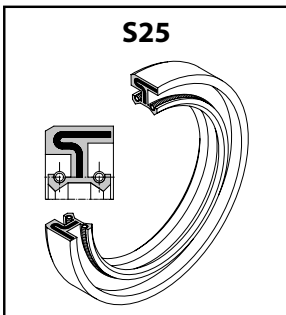
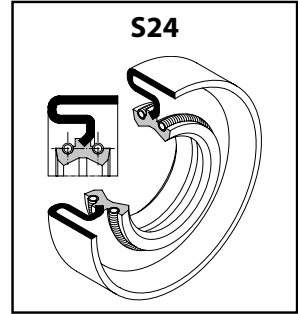
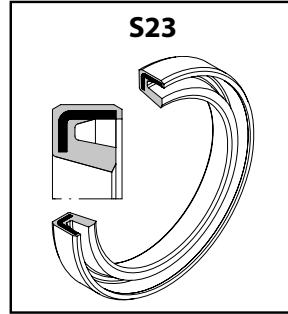
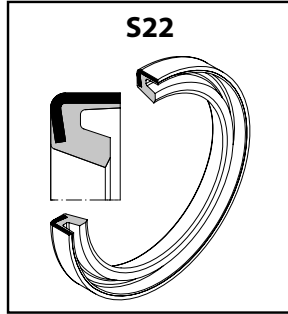
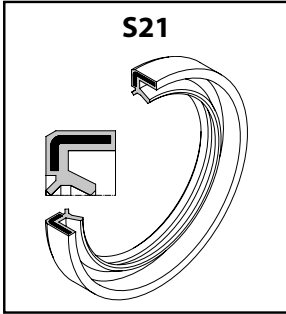



TECHNICAL DETAIL: OIL SEAL

TYPES

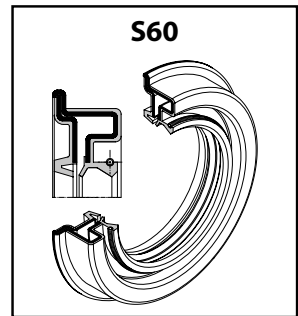
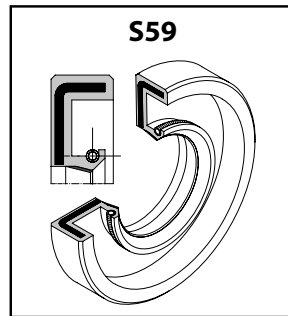
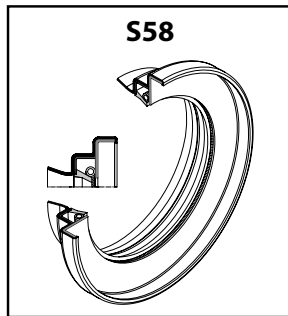
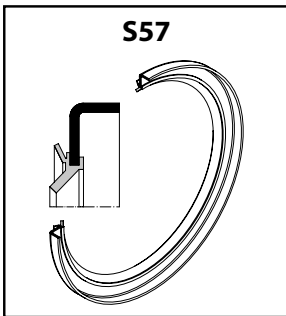
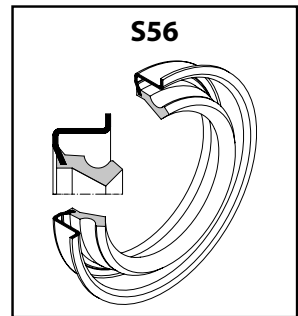
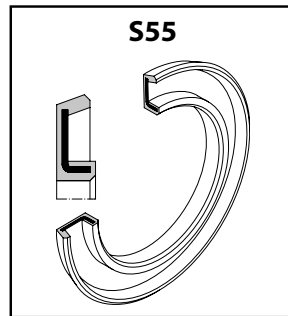
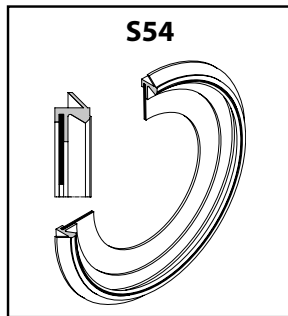
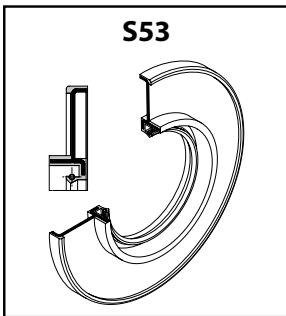
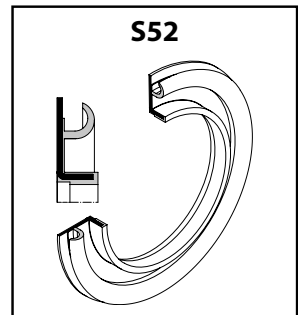
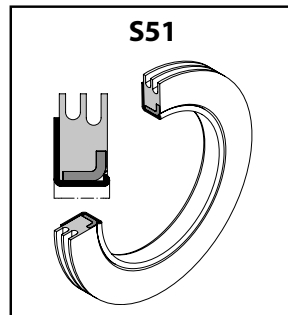
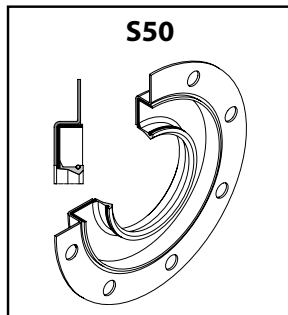
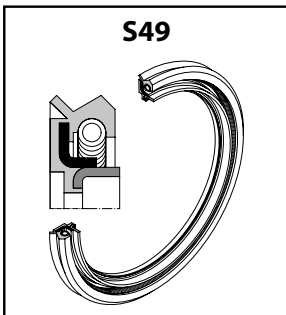
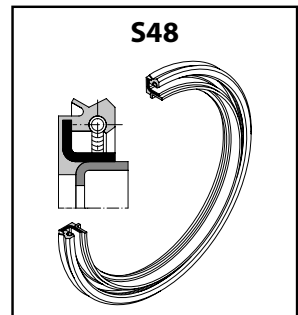
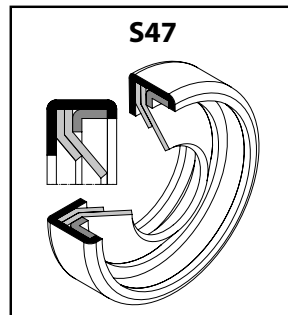
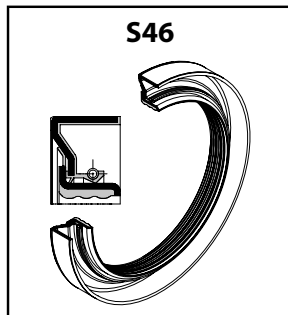
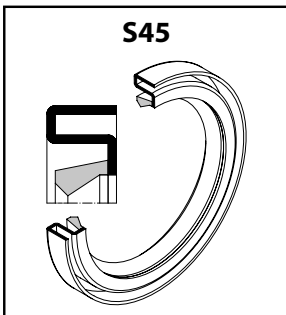
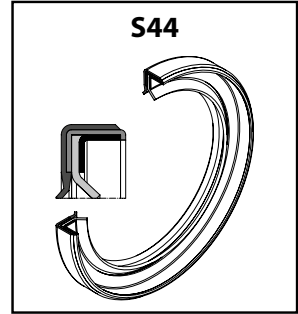
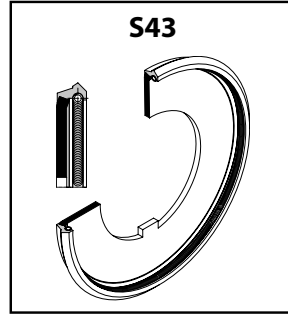
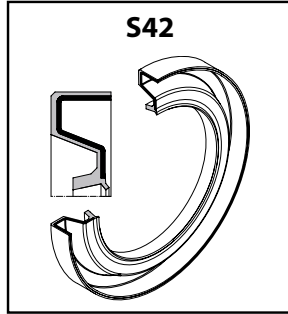
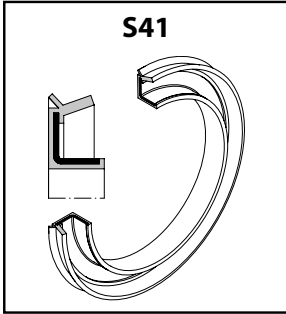



TECHNICAL DETAIL: OIL SEAL

TYPES

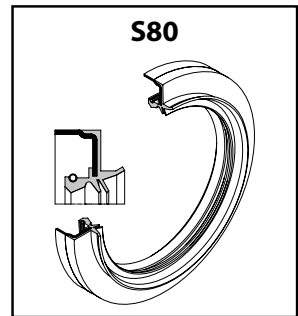
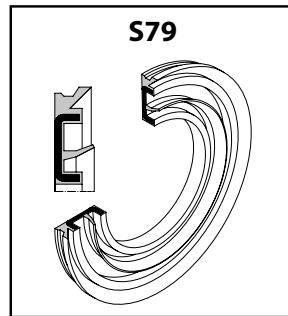
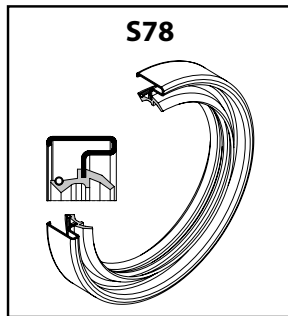
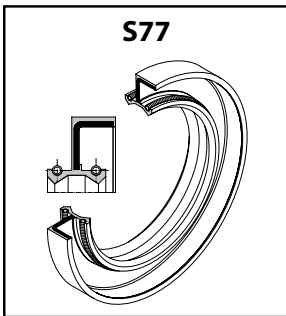
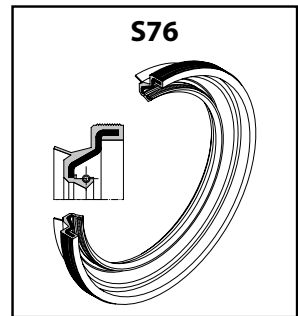
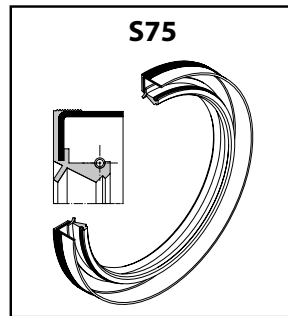
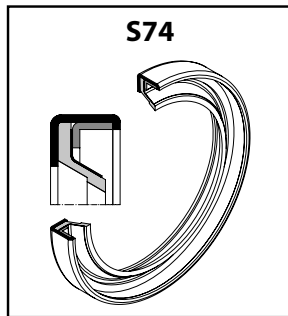
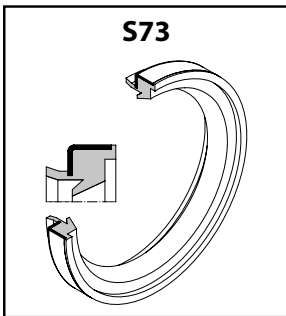
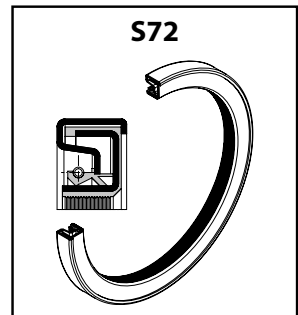
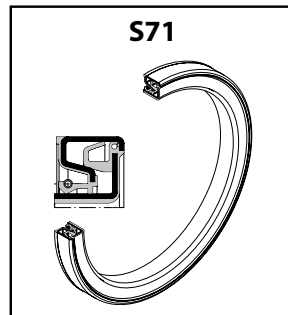
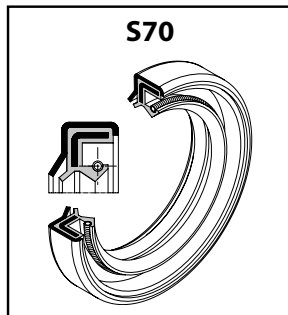
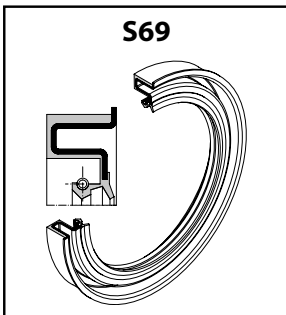
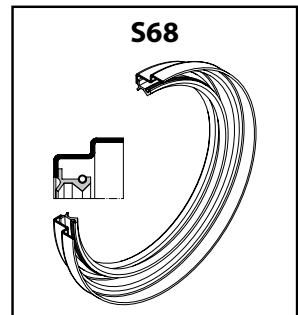
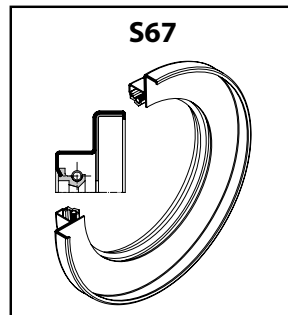
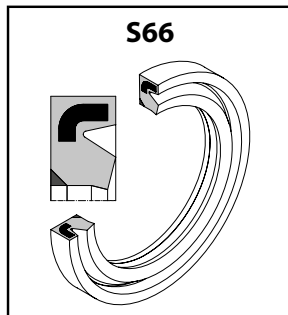
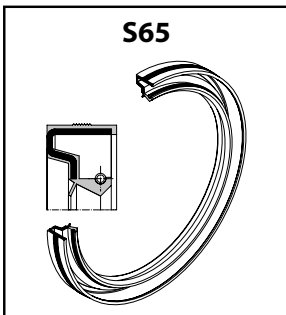
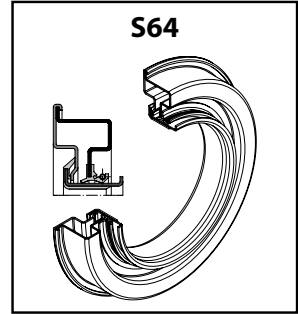
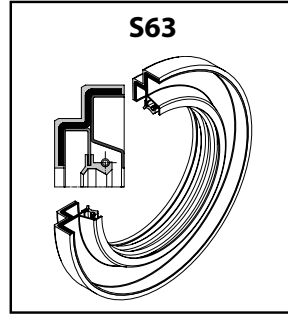
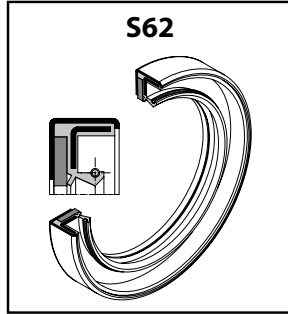
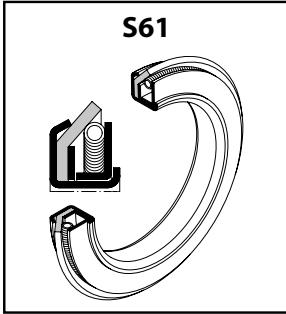



TECHNICAL DETAIL: OIL SEAL

TYPES

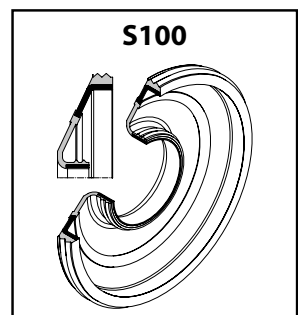
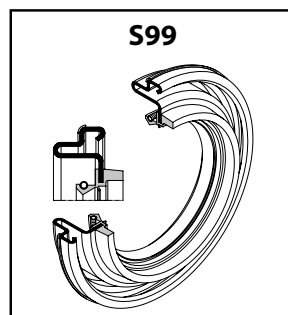
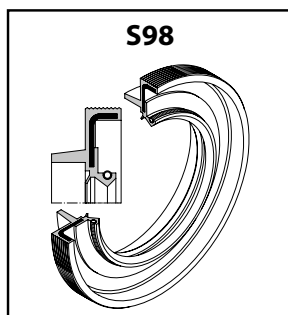
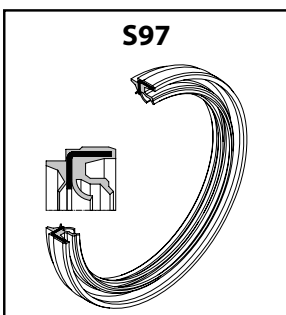
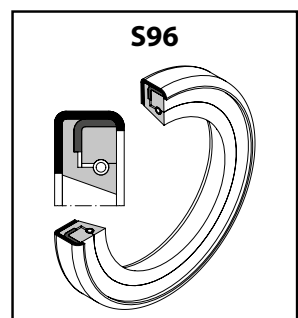
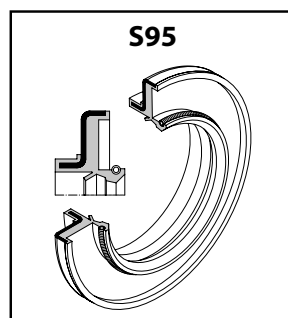
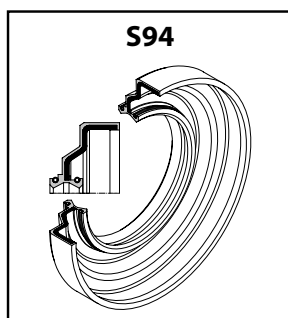
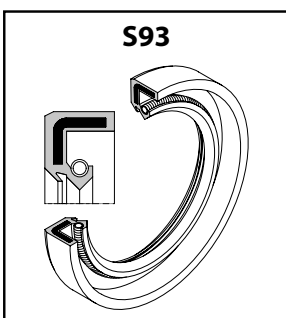
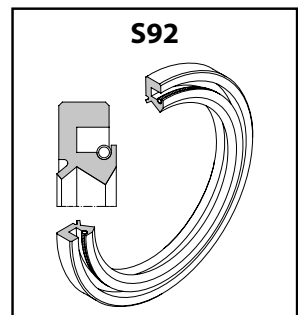
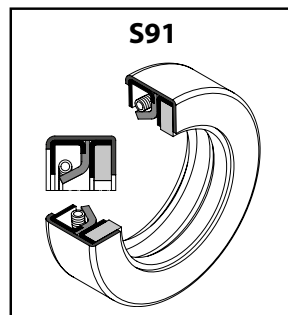
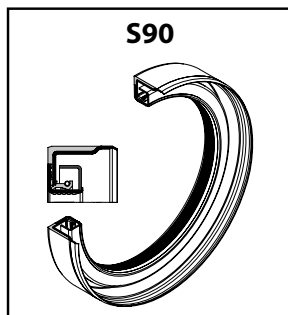
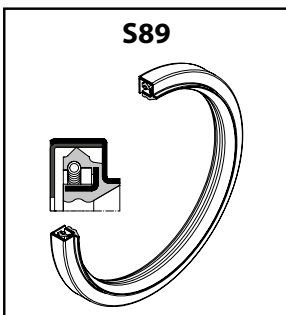
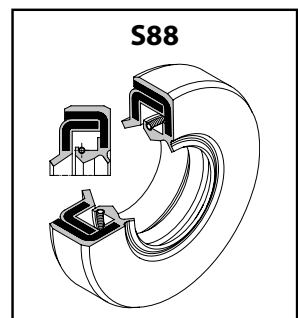
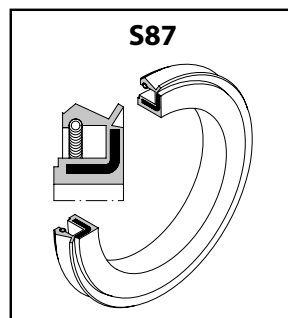
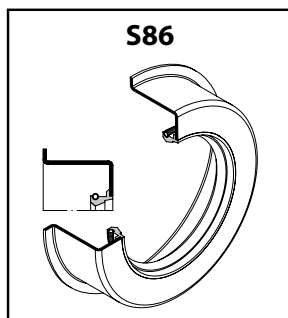
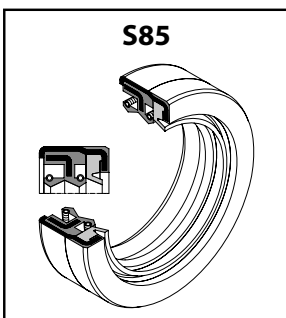
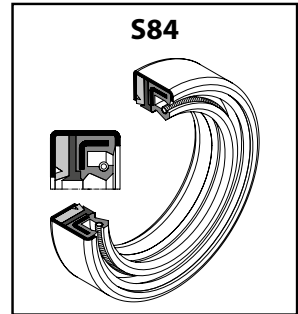
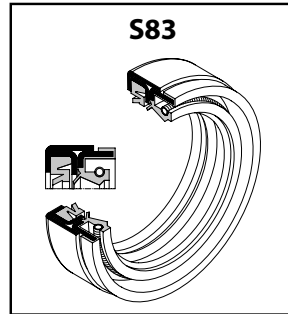
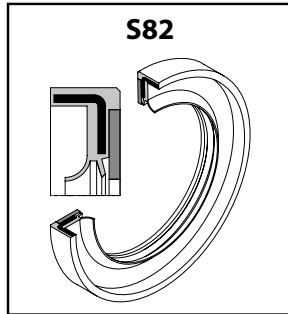
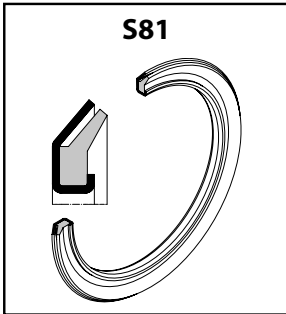



TECHNICAL DETAIL: OIL SEAL

TYPES

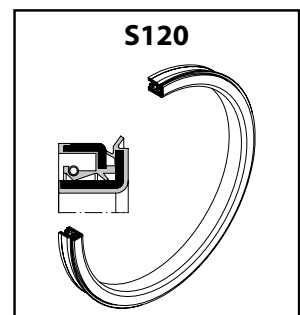
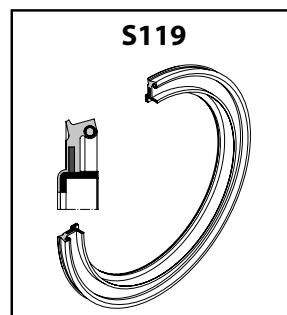
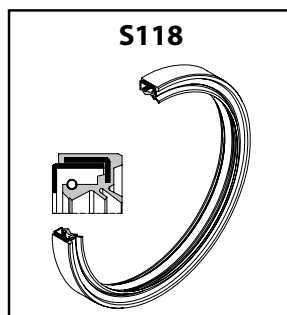
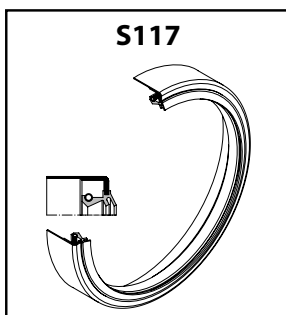
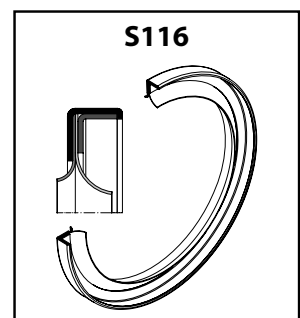
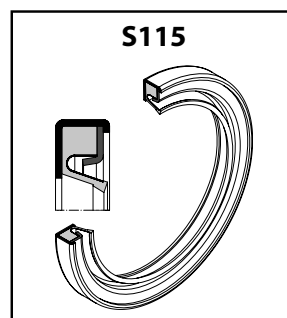
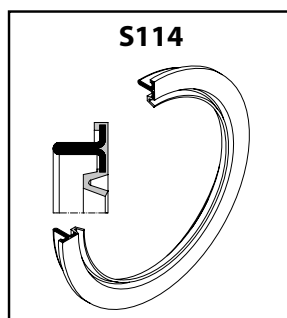
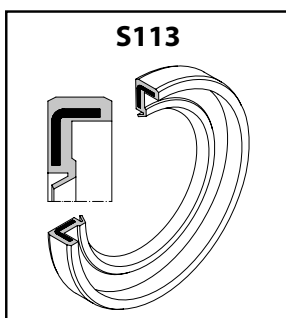
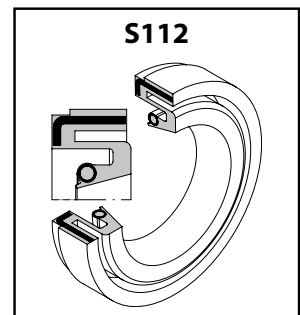
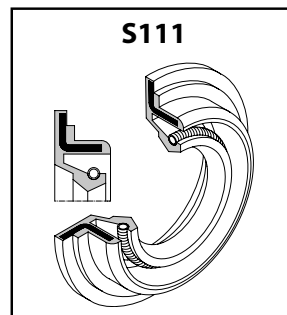
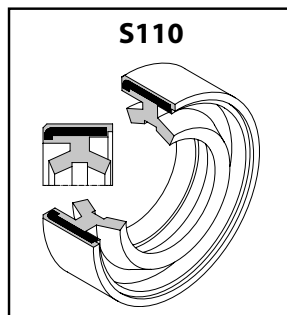
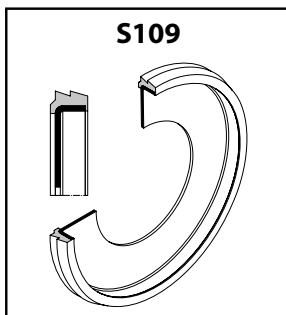
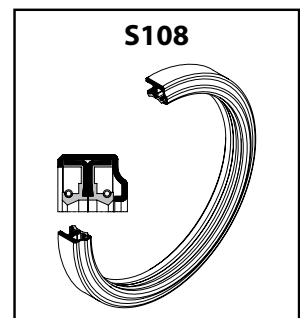
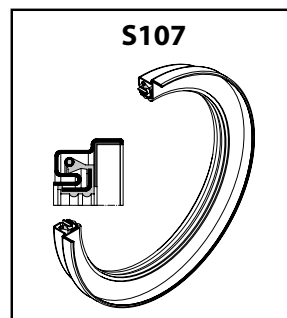
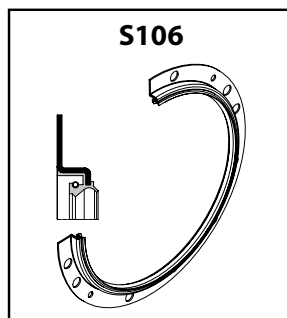
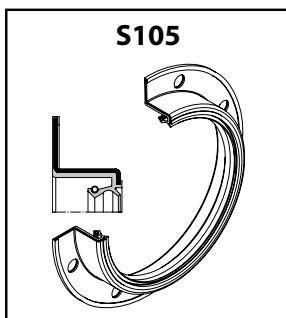
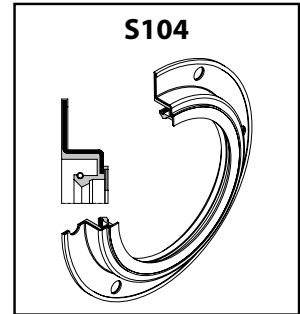
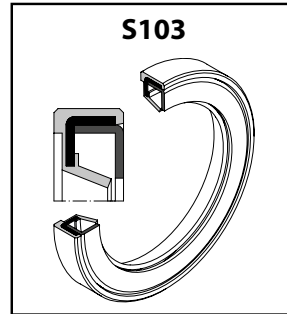
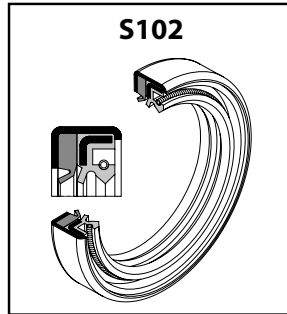
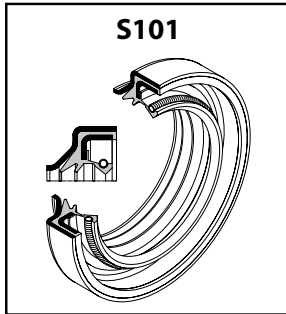



TECHNICAL DETAIL: OIL SEAL

TYPES

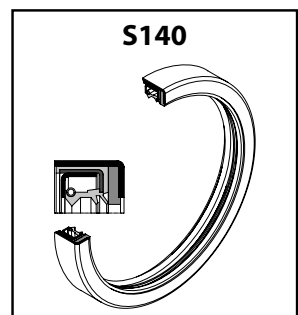
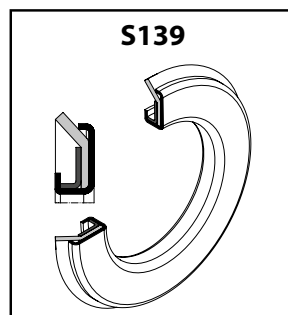
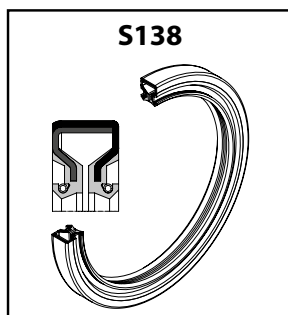
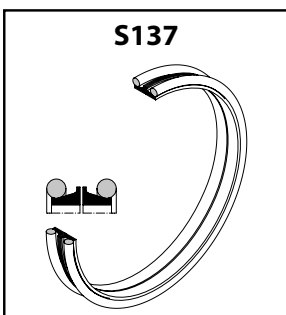
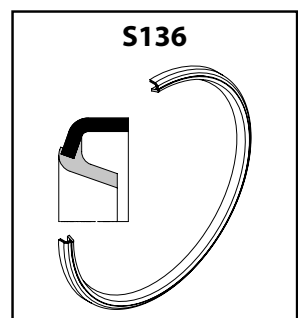
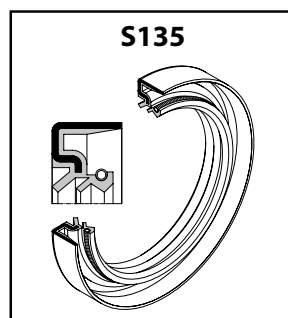
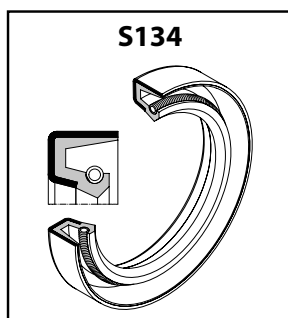
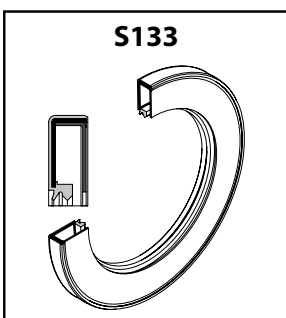
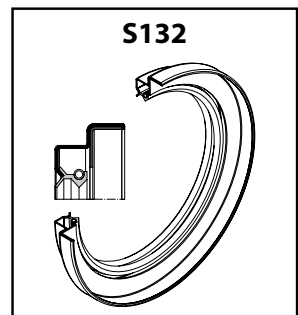
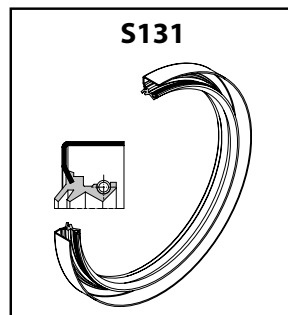
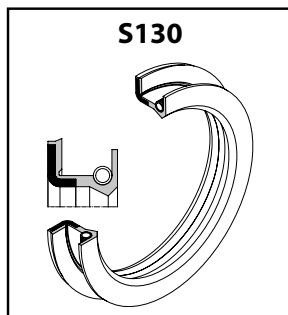
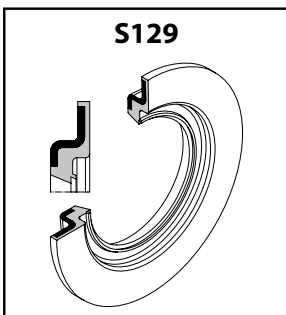
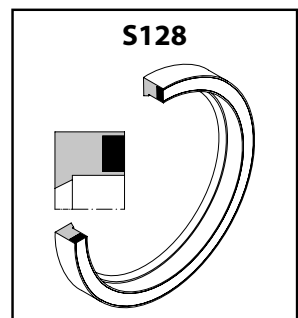
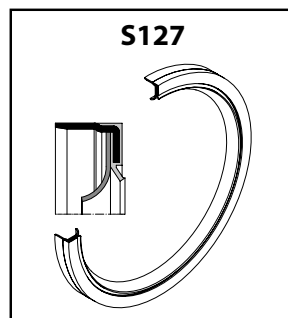
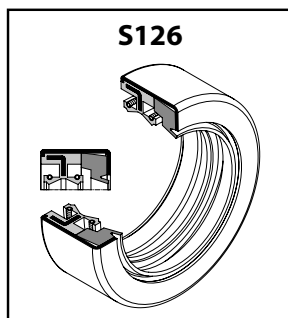
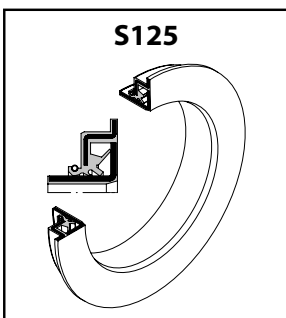
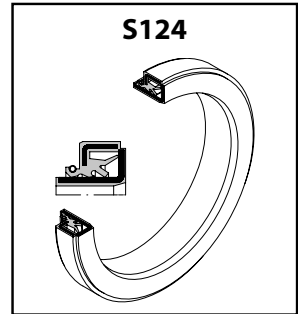
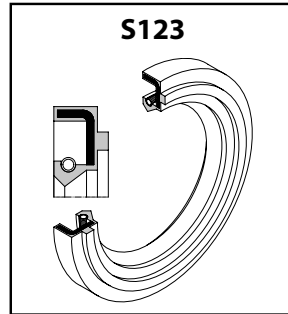
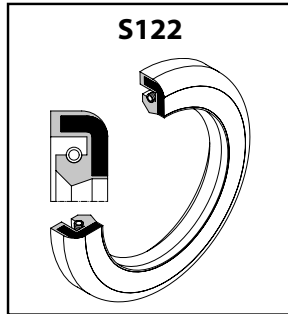
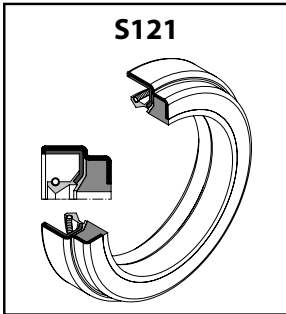



TECHNICAL DETAIL: OIL SEAL

TYPES

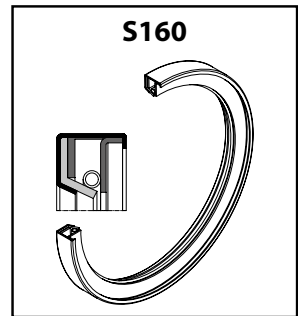
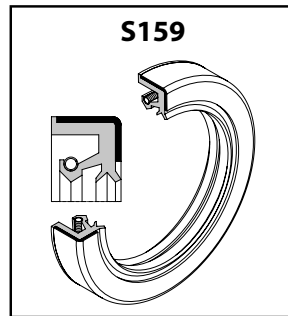
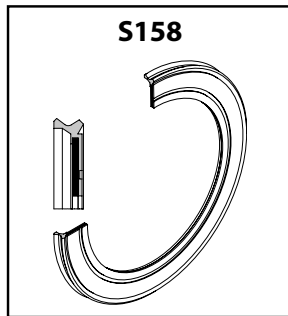
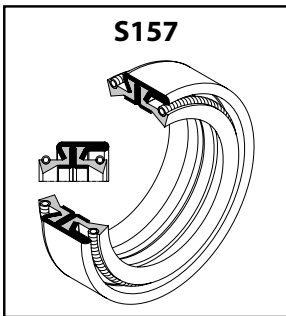
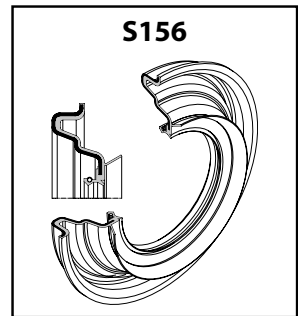
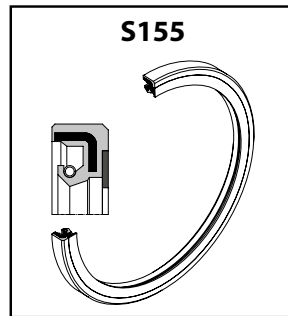
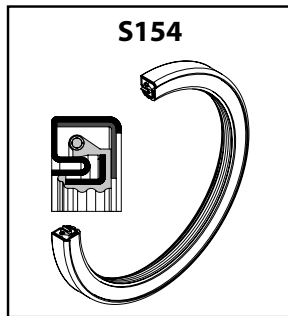
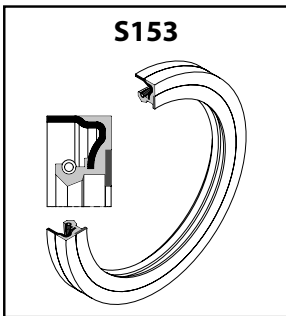
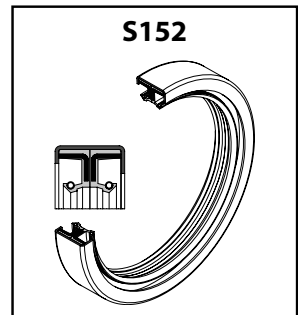
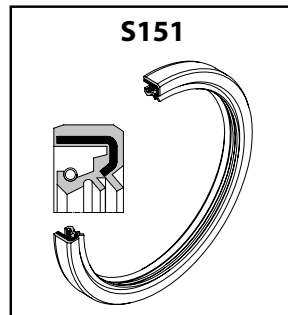
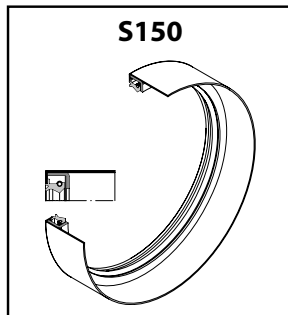
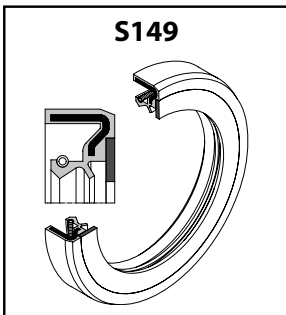
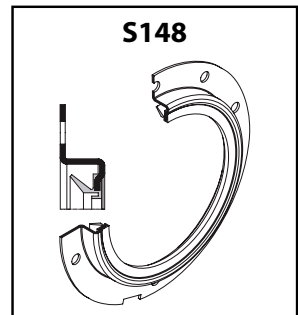
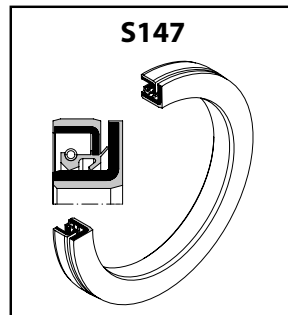
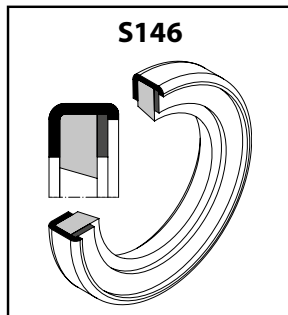
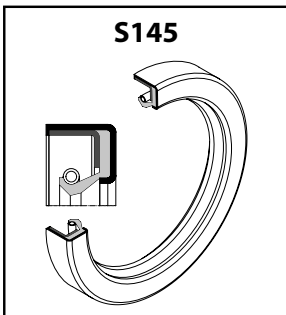
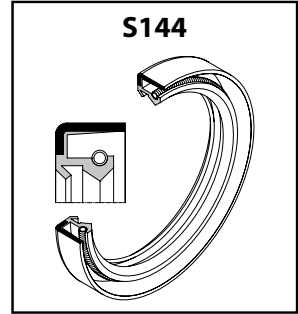
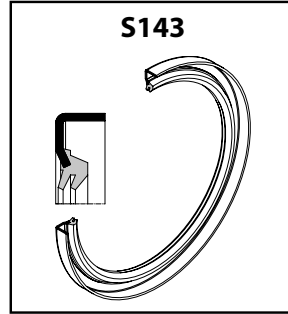
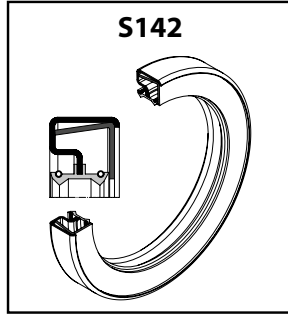
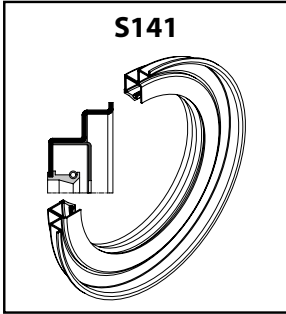



TECHNICAL DETAIL: OIL SEAL

TYPES

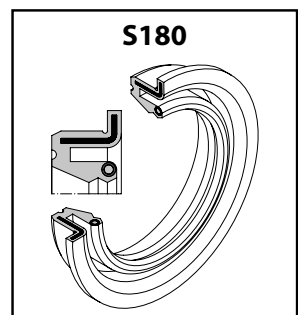
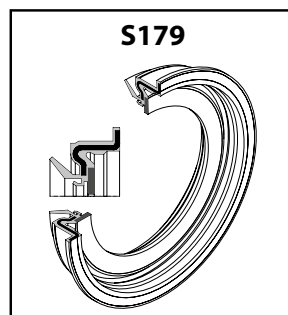
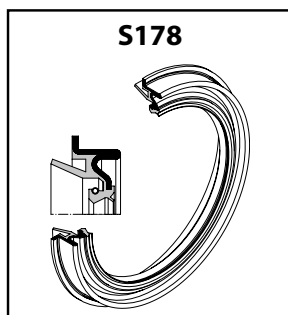
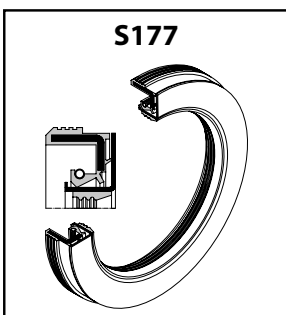
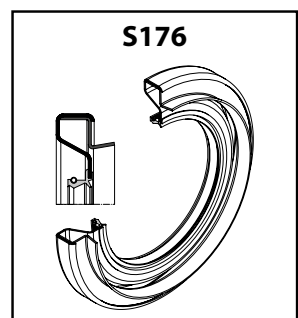
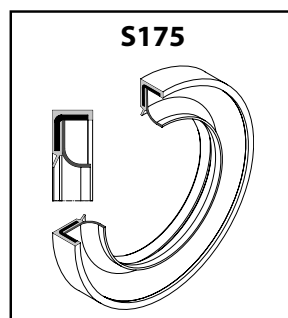
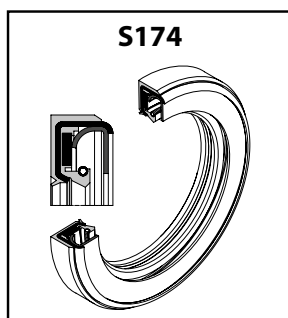
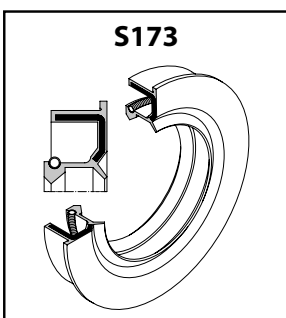
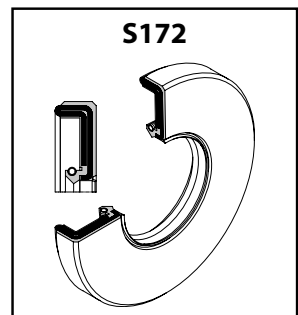
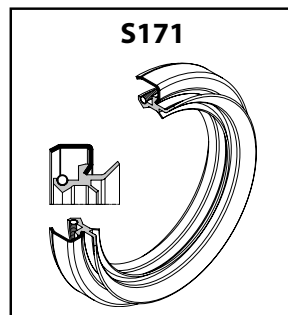
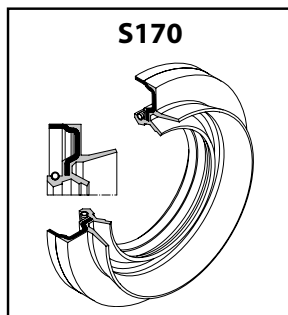
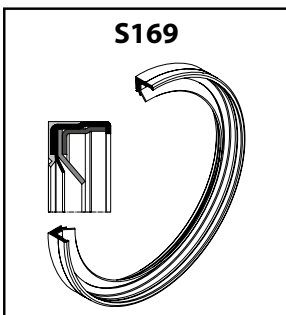
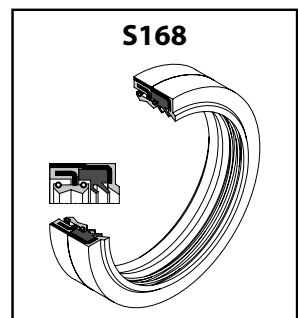
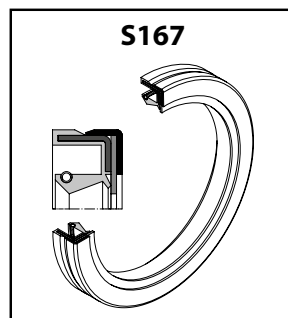
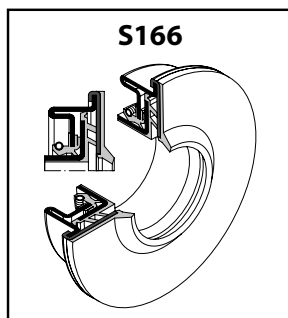
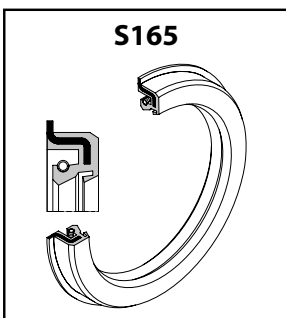
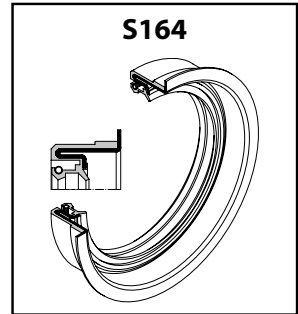
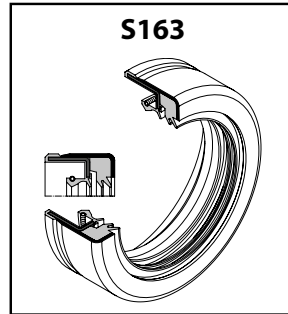
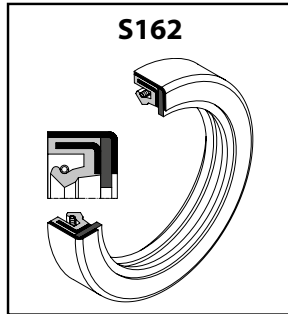
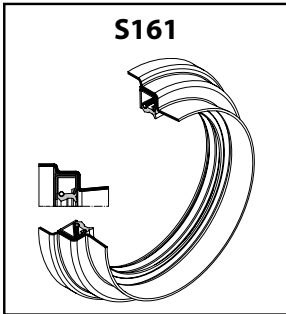



TECHNICAL DETAIL: OIL SEAL

TYPES

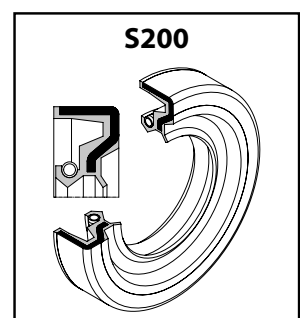
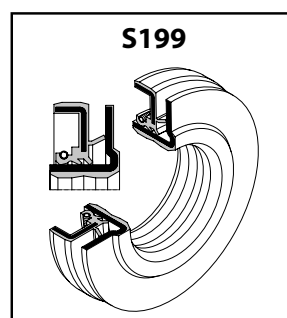
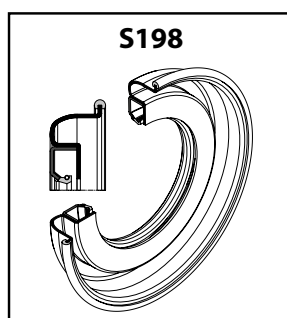
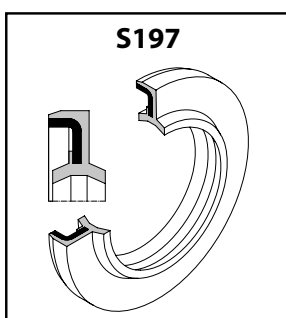
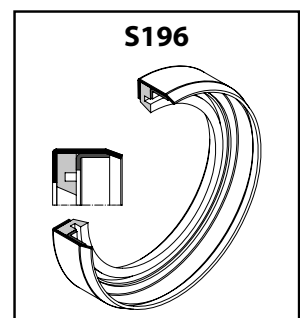
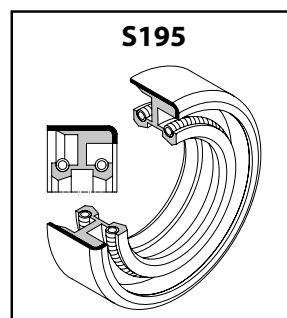
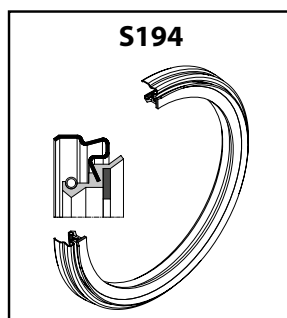
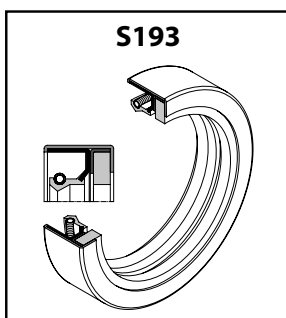
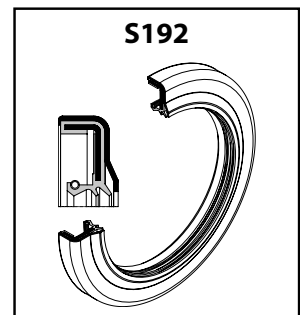
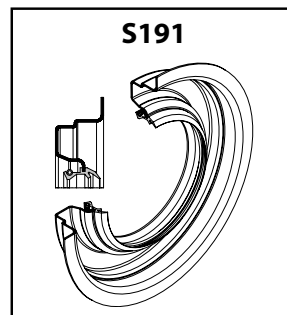
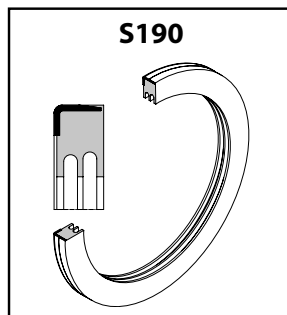
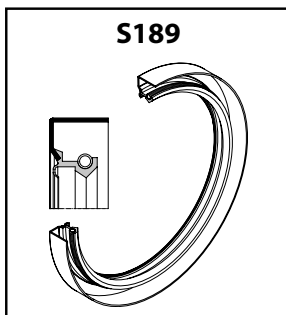
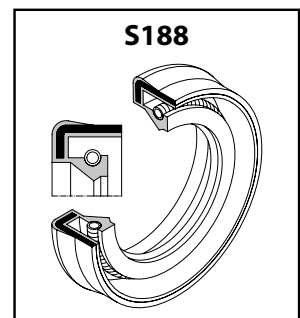
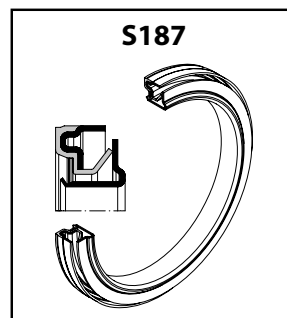
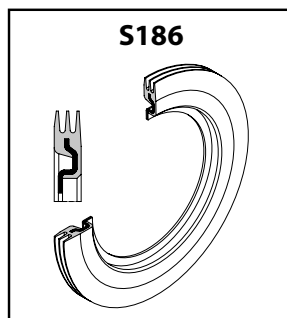
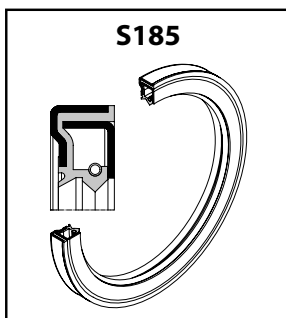
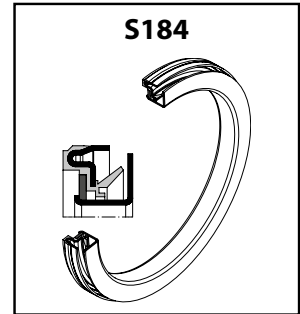
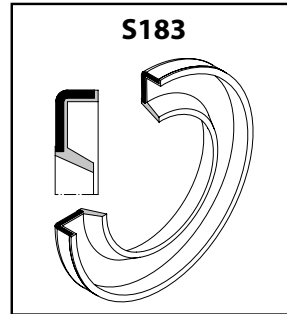
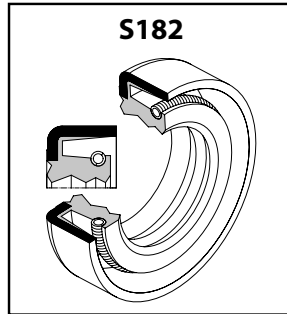
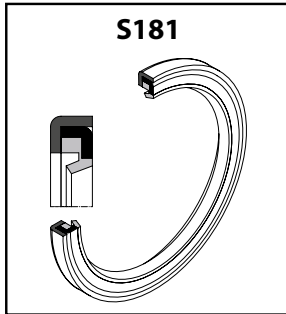



TECHNICAL DETAIL: OIL SEAL

TYPES

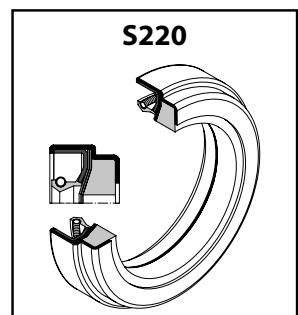
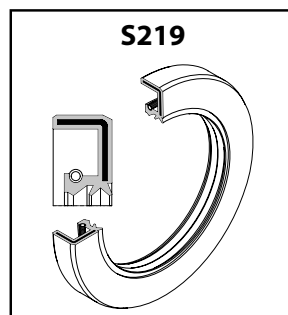
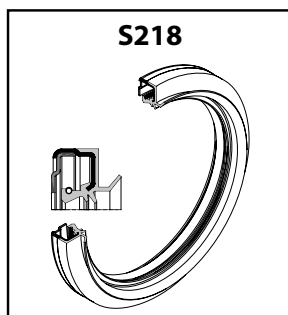
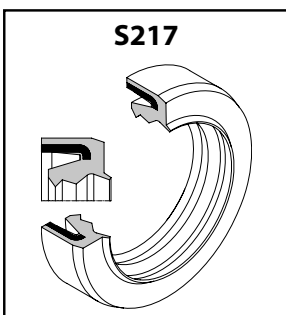
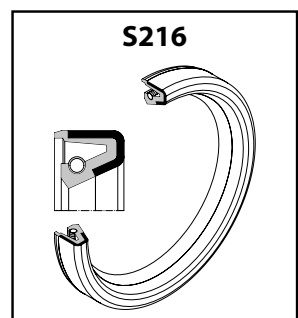
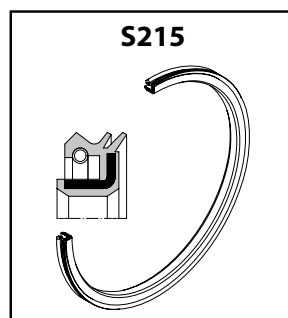
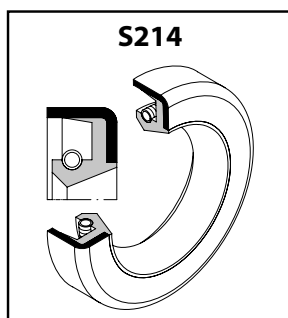
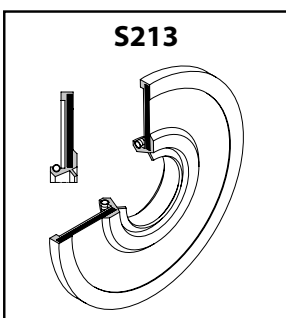
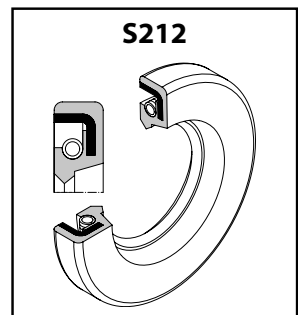
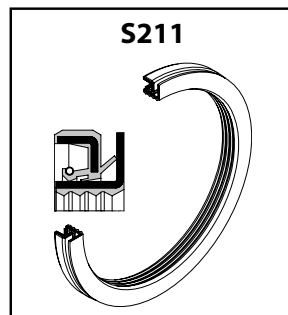
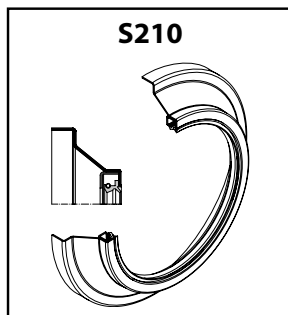
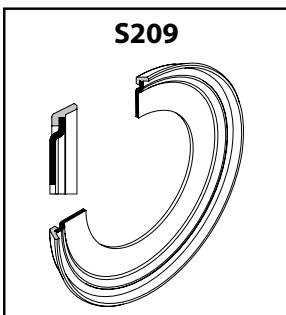
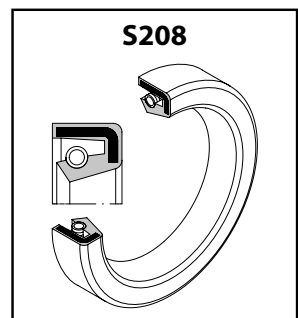
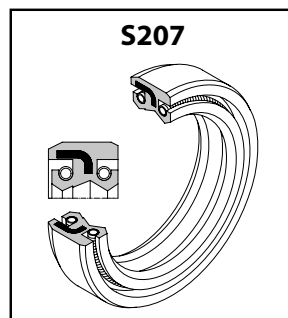
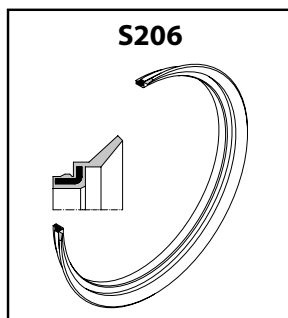
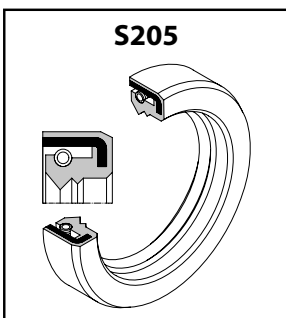
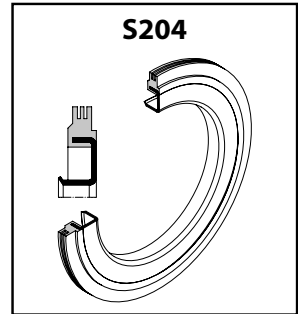
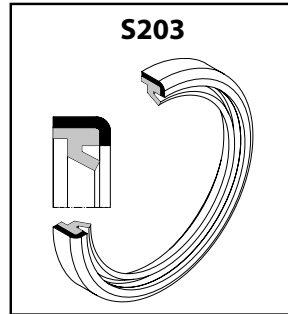
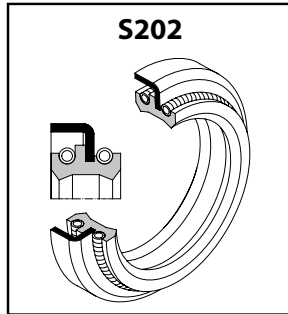
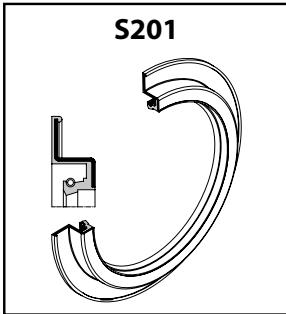



TECHNICAL DETAIL: OIL SEAL

TYPES

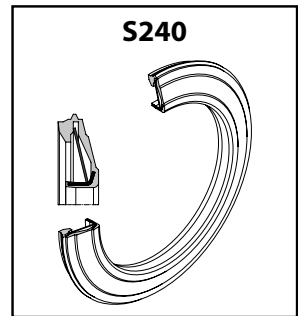
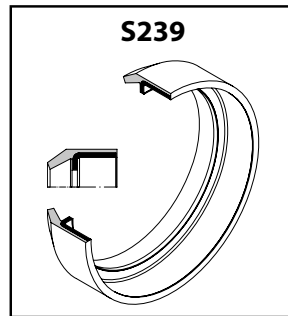
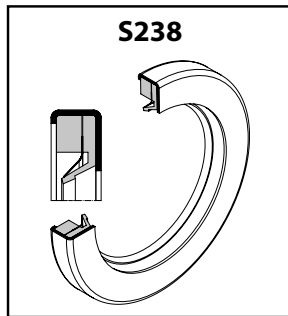
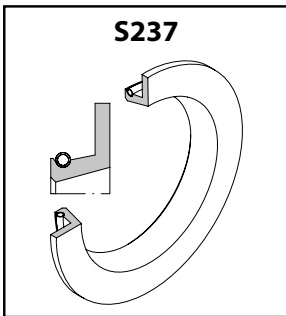
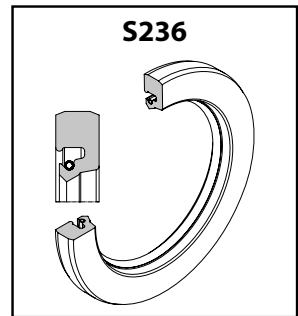
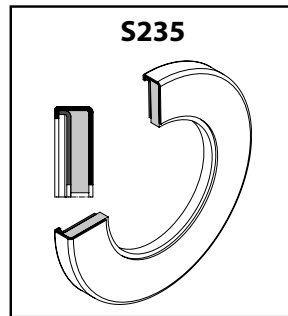
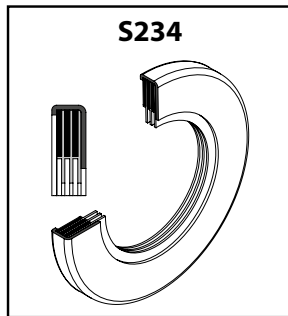
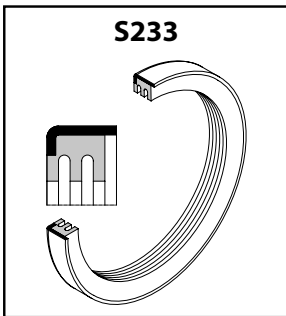
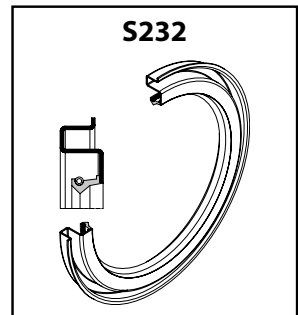
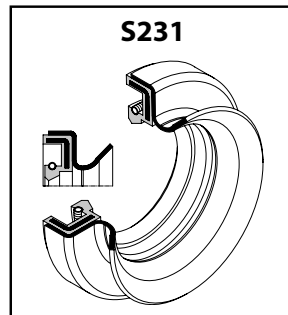
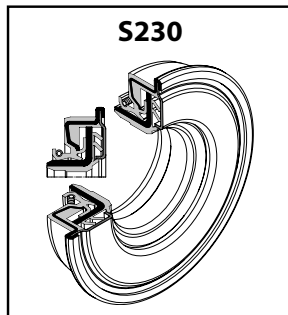
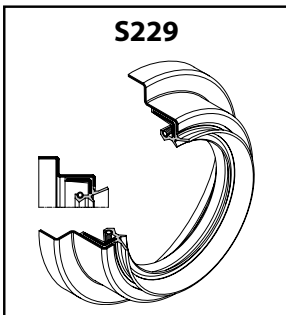
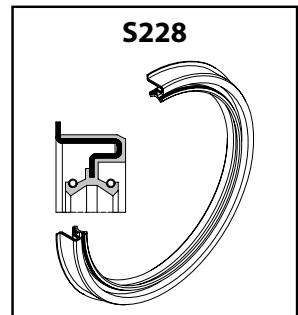
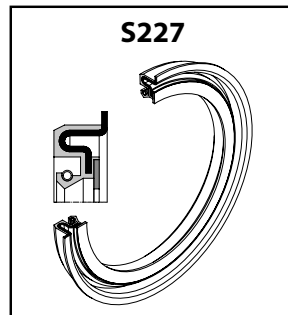
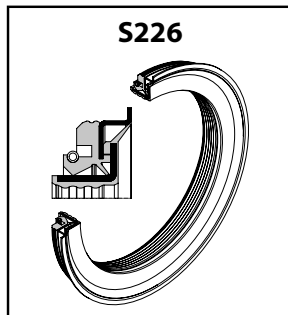
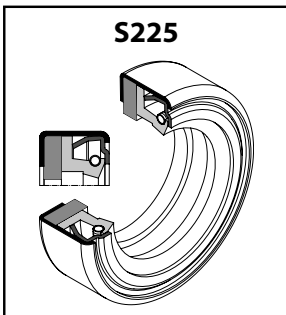
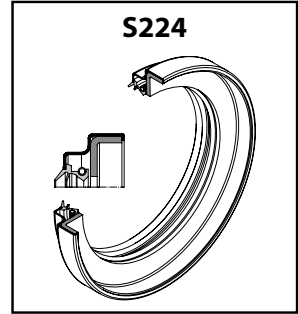
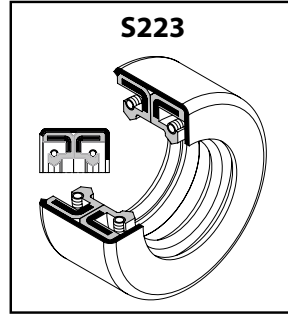
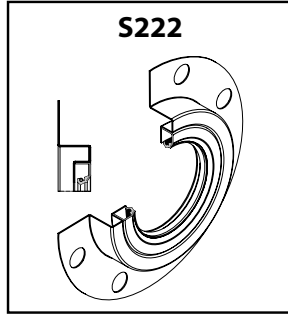
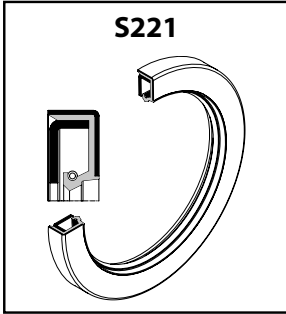



TECHNICAL DETAIL: OIL SEAL

TYPES

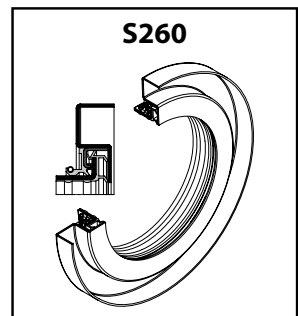
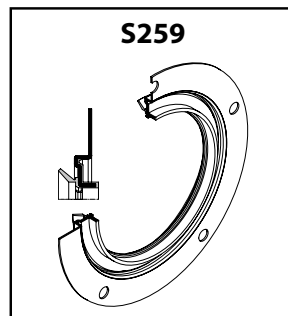
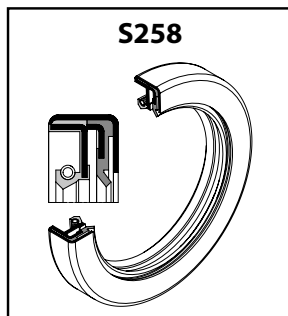
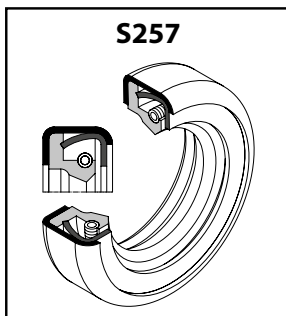
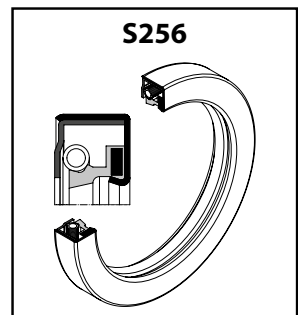
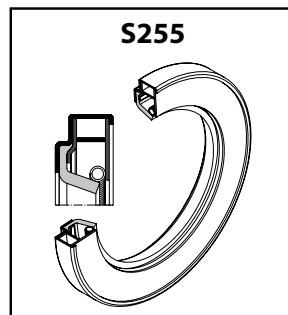
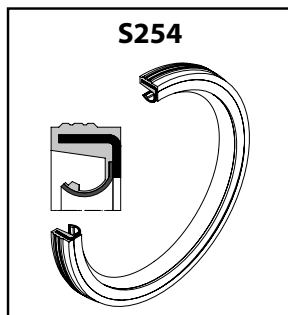
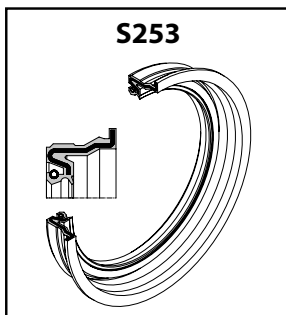
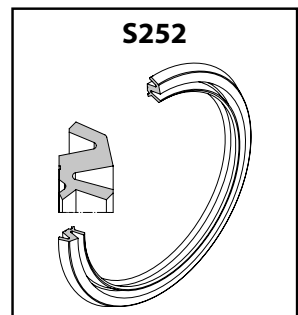
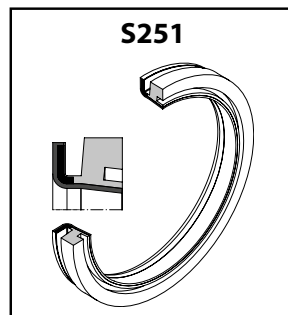
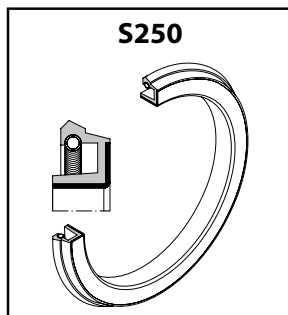
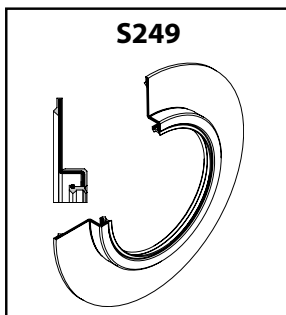
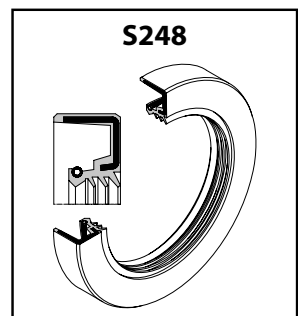
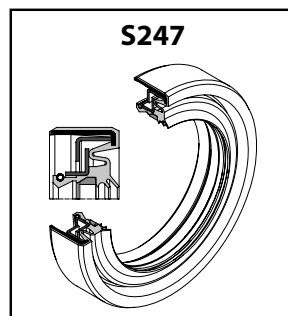
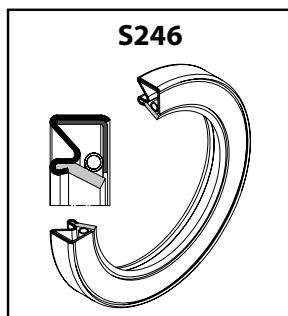
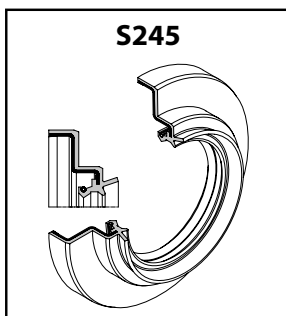
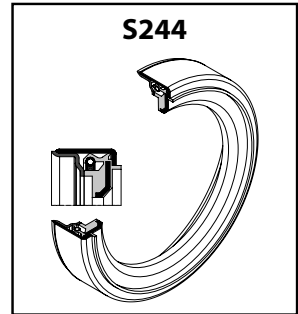
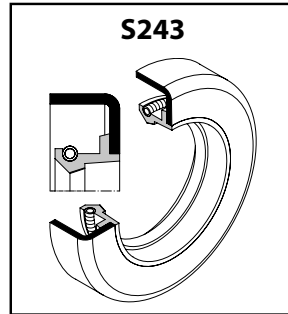
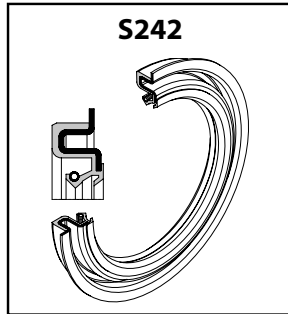
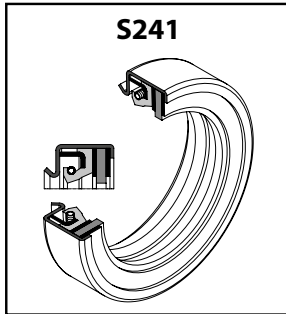



TECHNICAL DETAIL: OIL SEAL

TYPES

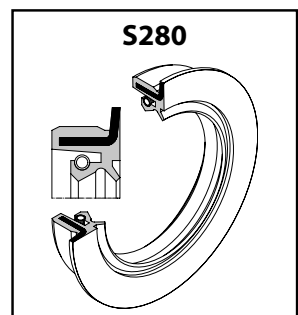
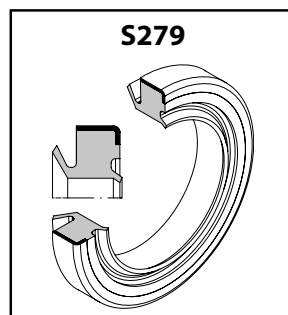
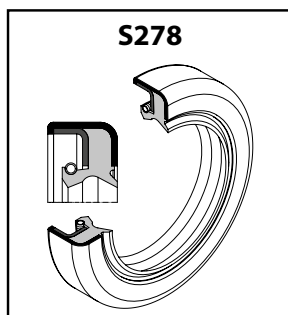
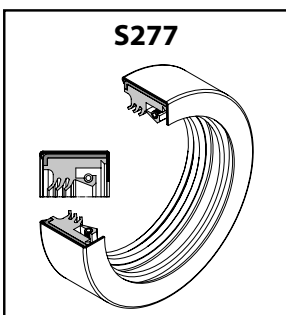
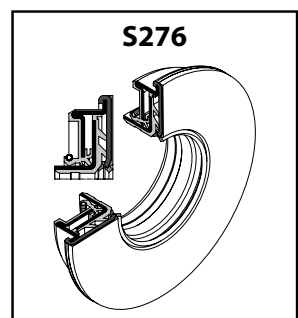
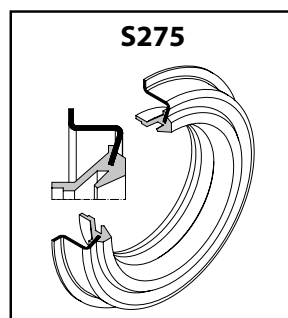
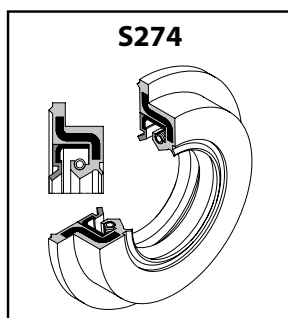
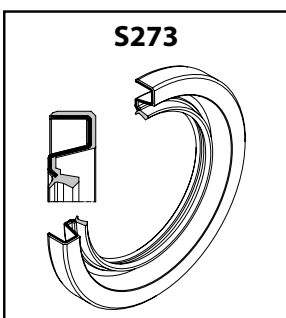
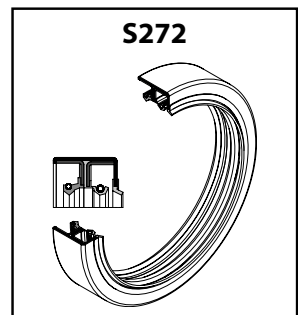
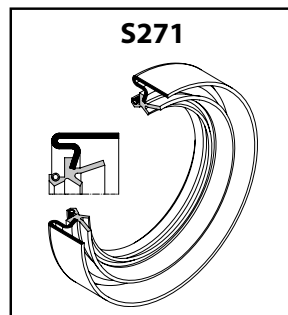
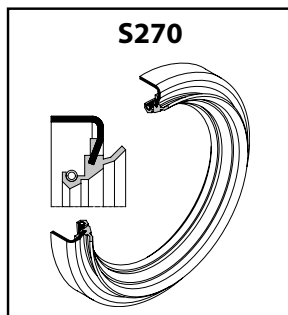
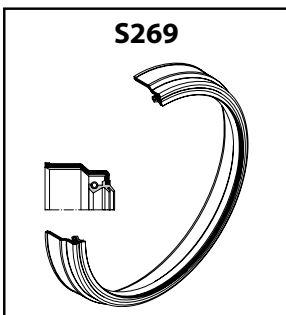
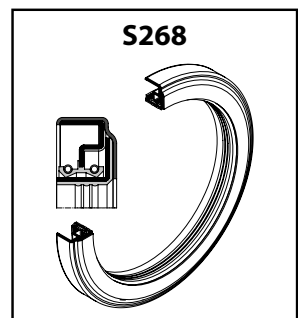
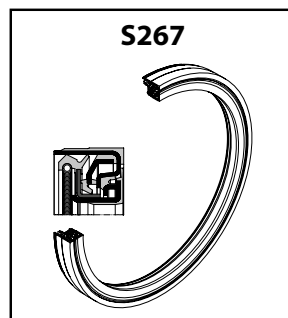
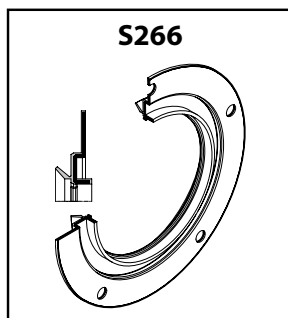
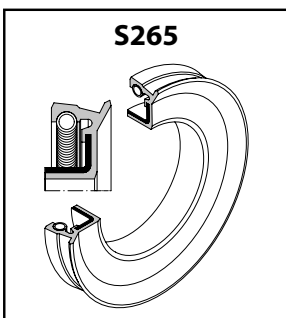
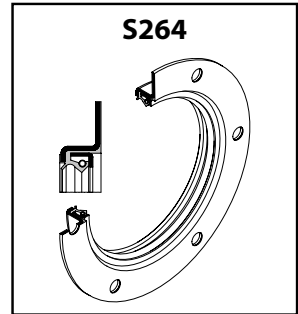
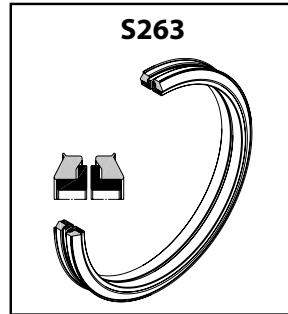
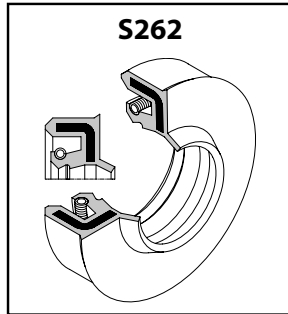
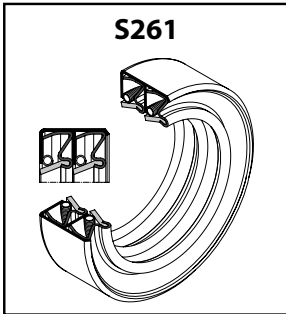



TECHNICAL DETAIL: OIL SEAL

TYPES

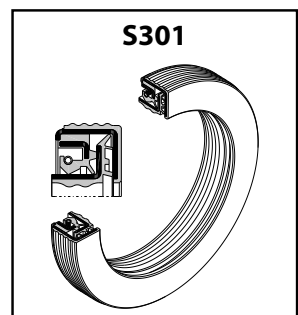
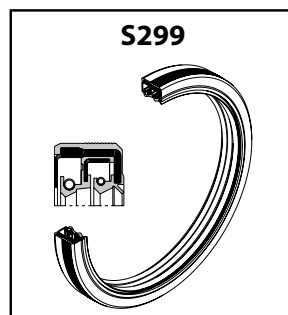
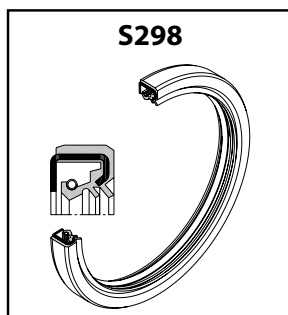
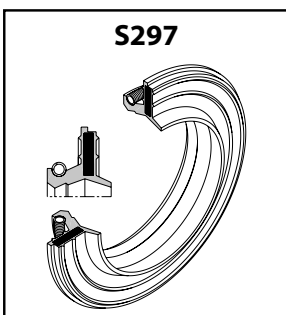
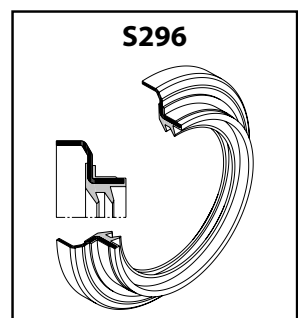
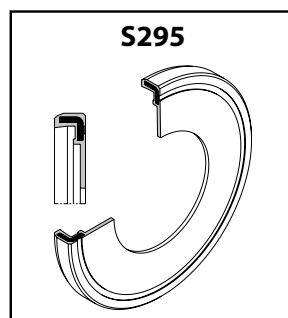
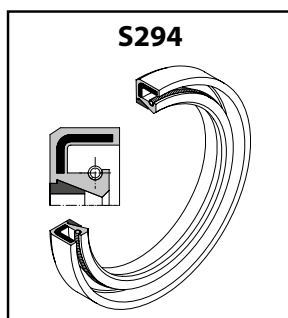
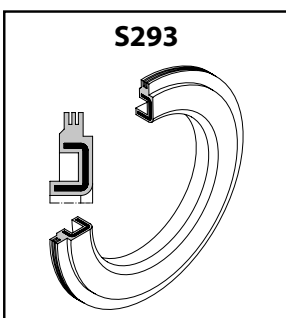
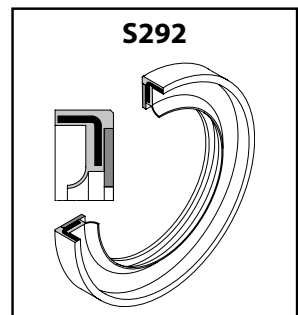
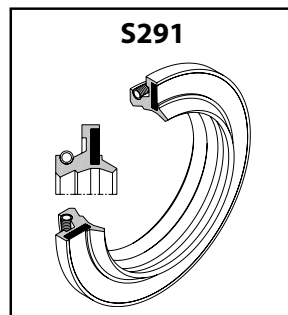
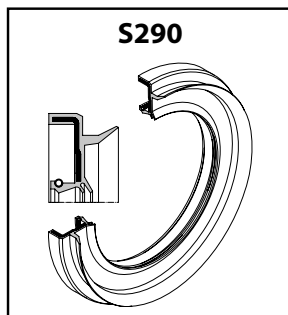
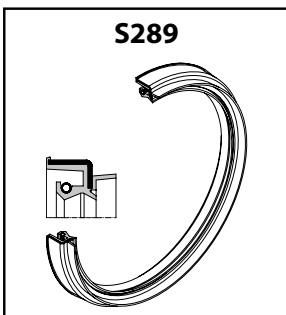
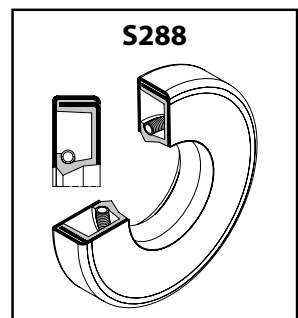
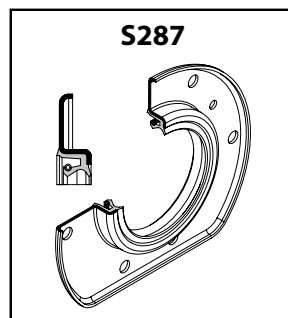
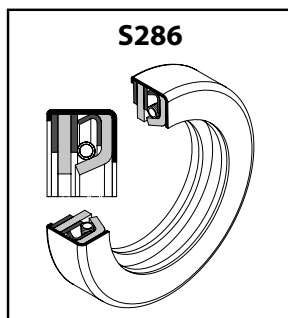
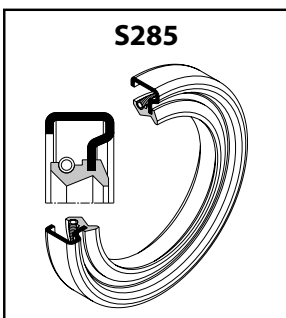
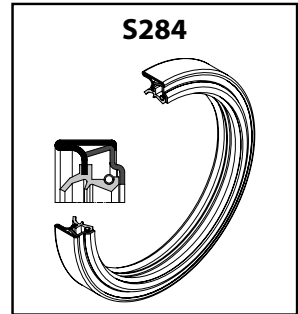
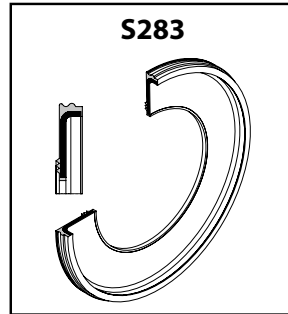
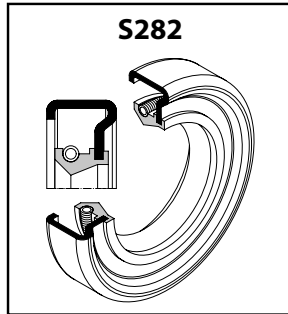
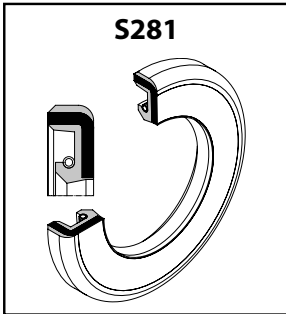



TECHNICAL DETAIL: OIL SEAL

Groep
03-03-02-00



Gegevens klant

Type machine: Prijsaanvraag
 Serienr. machine: Bestelling

CODE: TY x VE x MI x D1 x D2 x H1 x D3 x D4 x H3 x MAT x DR x AT-GA x GLV



- TY..... Type oliekeerring.
- VE..... Veer aanwezig: JA/NEE/DUBBEL.
- MI..... Eenheid:
 M = metrisch
 I = duim
- D1 Buitendiameter (mm).
- D2 Binnendiameter (mm).
- H1 Hoogte (mm).
- D3 Buitendiameter (duim).
- D4 Binnendiameter (duim).
- H3 Hoogte (duim).
- MAT..... Materiaal:
 AL = aluminium
 F = vilt
 KS = kunststof
 LE = leder
 M = metaal
 MB = metaal geblindeerd
 NY = nylon
 PTFE = teflon
 PTFEB = teflon – brons
 PU = polyurethane
 R = rubber
 S = silicone
 V = viton
 ACM = acrylrubber

zie Engelse technische fiche !



TECHNICAL DETAIL: OIL SEAL

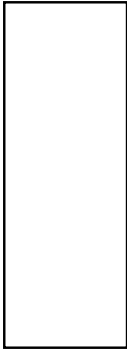

DR Draairichting:
R = rechtse rotatie
L = linkse rotatie
W = linkse en rechtse rotatie
Z = geen draairichting

AT-GA..... Aantal gaten.

GLV Golving: JA/NEE (zie figuur).

AFMETINGEN

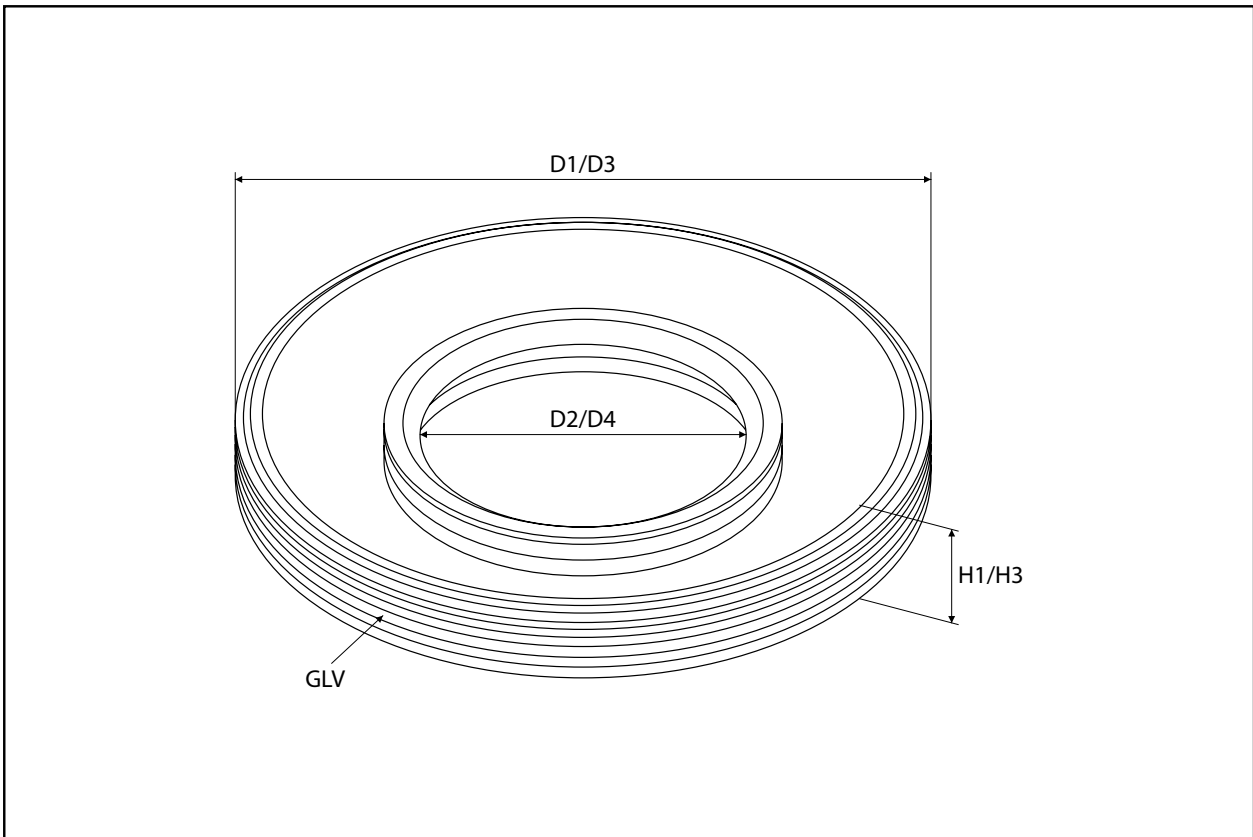

zie Engelse technische fiche !



TECHNICAL DETAIL: OIL SEAL

Groupe
03-03-02-00



Données client

Type machine :

Demande de prix

No. série machine :

Commande

CODE : TY x VE x MI x D1 x D2 x H1 x D3 x D4 x H3 x MAT x DR x AT-GA x GLV



- TY..... Type de bague d'étanchéité.
- VE..... Ressort present : OUI/NON/DOUBLE.
- MI..... Unité :
 - M = Métrique
 - I = Impériale
- D1 Diamètre extérieur (mm).
- D2 Diamètre intérieur (mm).
- H1 Hauteur (mm).
- D3 Diamètre extérieur (pouce).
- D4 Diamètre intérieur (pouce).
- H3 Hauteur (pouce).
- MAT..... Matière :
 - AL = aluminium
 - F = feutre
 - KS = plastique
 - LE = cuir
 - M = métall
 - MB = métal blindé
 - NY = nylon
 - PTFE = téflon
 - PTFEB = téflon - bronze
 - PU = polyurethane
 - R = caoutchouc
 - S = silicone
 - V = viton
 - ACM = caoutchouc acrylique

voir la fiche technique en Anglais.



TECHNICAL DETAIL: OIL SEAL

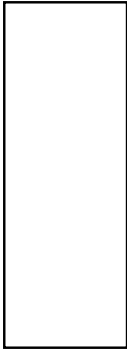

DR Sens de rotation :
R = rotation a droite
L = rotation a gauche
W = bi-directionnelle
Z = pas de sens de rotation

AT-GA..... Nombre de trous.

GLV Ondulation : OUI/NON (voir figure).

DIMENSIONS

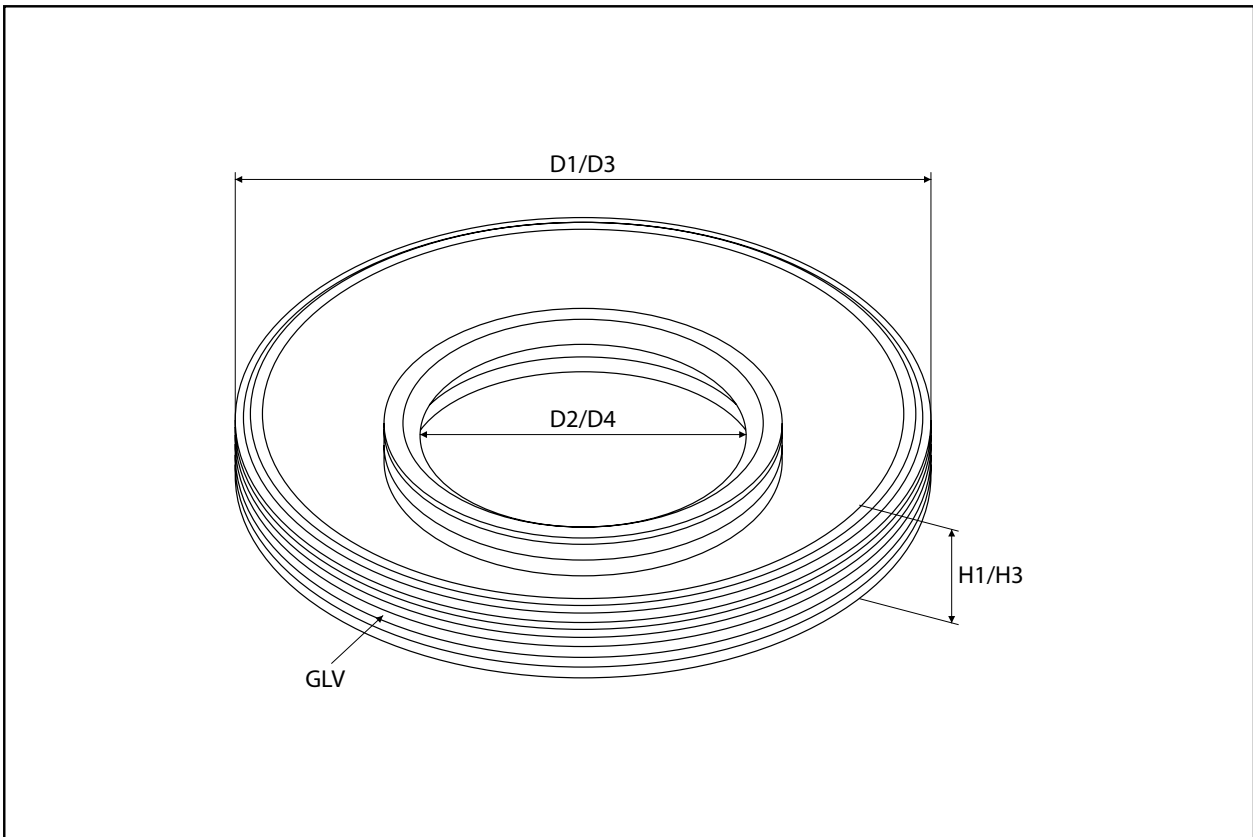

voir la fiche technique en Anglais.



TECHNICAL DETAIL: OIL SEAL

Gruppe
03-03-02-00



Kundendaten

Maschinentyp:

Preis Anfrage

Serien-Nr. Maschine:

Bestellung

CODE: TY x VE x MI x D1 x D2 x H1 x D3 x D4 x H3 x MAT x DR x AT-GA x GLV



- TY..... Typ Simmerring.
- VE..... Feder anwesend: JA/NEIN/DOPPELT.
- MI..... Einheit:
 - M= metrisch
 - I = Daumen
- D1 Aussendurchmesser (mm).
- D2 Innendurchmesser (mm).
- H1 Höhe (mm).
- D3 Aussendurchmesser (Daumen).
- D4 Innendurchmesser (Daumen).
- H3 Höhe (Daumen).
- MAT..... Material:
 - AL = Aluminium
 - F = Filz
 - KS = Kunststoff
 - LE = Leder
 - M = Metall
 - MB = Metall geblendet
 - NY = Nylon
 - PTFE = Teflon
 - PTFEB = Teflon – bronze
 - PU = Polyurethan
 - R = Gummi
 - S = Silikon
 - V = Viton
 - ACM = Acrylgummi

Siehe technische Datenblätter auf Englisch.



TECHNICAL DETAIL: OIL SEAL

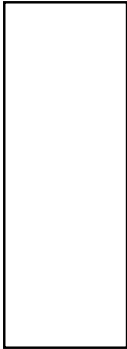

DR Drehrichtung:
R = Drehung rechts
L = Drehung links
W = Drehung links und rechts
Z = Keine drehrichtung

AT-GA Anzahl Löcher.

GLV Wellung: JA/NEIN (siehe figur).

ABMESSUNGEN

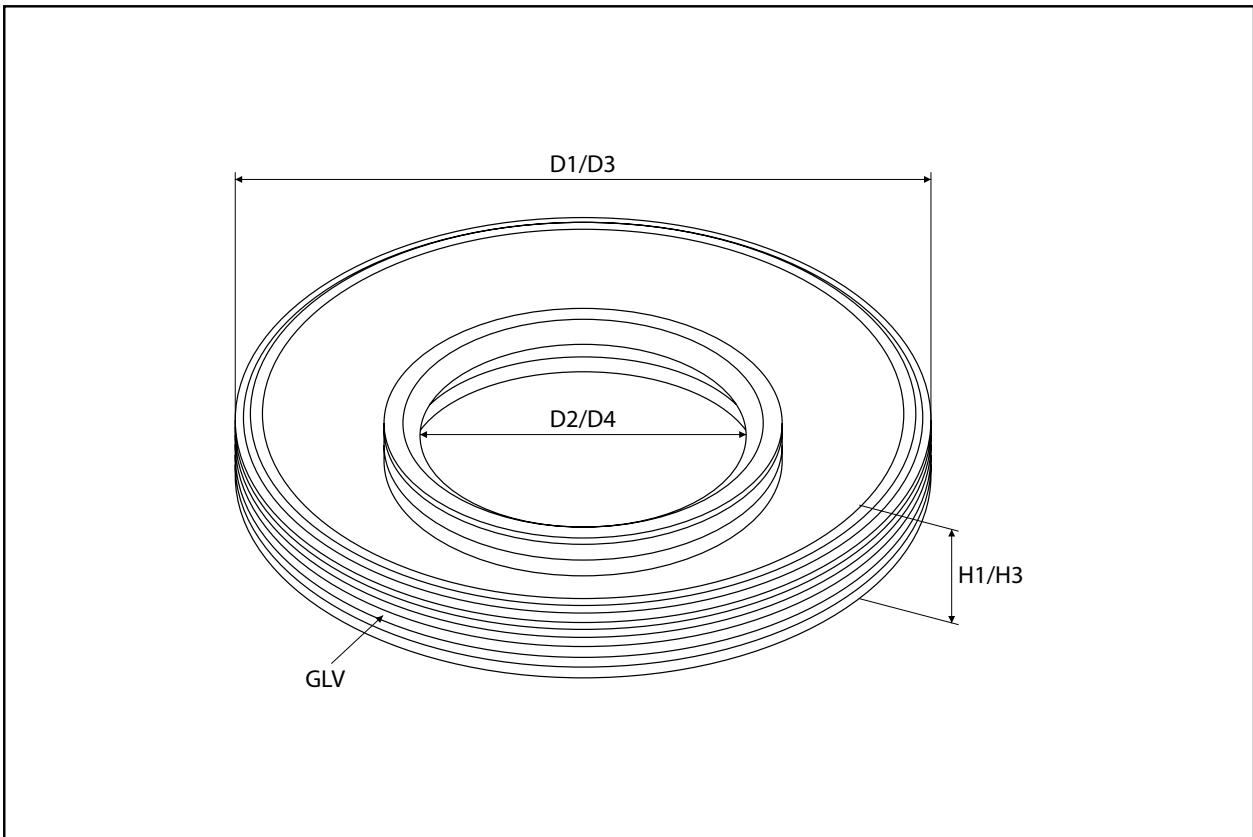

Siehe technische Datenblätter auf Englisch.



SPEEDI SLEEVE MEASUREMENT TABLE

$\emptyset d$	B1	REF
20		107TA5855
22,23		107TA5856
25		107TA5857
25,4		107TA5858
27		107TA5859
28		107TA5860
28,58		107TA5861
30		107TA5862
31,8		107TA5863
32		107TA5864
33,35		107TA5865
34,01		107TA5866
34,93	12,7	107TA5867
34,93	13	107TA5868
36,6		107TA5869
38,1		107TA5870
40,08		107TA5871
41,28		107TA5872
41,9		107TA5873
44,45		107TA5874
45		107TA5875
46,05		107TA5876
47,63		107TA5877
48,03		107TA5878
48,56		107TA5879
49,23		107TA5880
50		107TA5881
50,8		107TA5882
52,4		107TA5883
53,98		107TA5884
55		107TA5885
55,58		107TA5886
57,15		107TA5887
60		107TA5888
60,33		107TA5889
61,93		107TA5890
63,5		107TA5891
65		107TA5892
66,68	12,7	107TA5893
66,68	19,8	107TA5894
69,85		107TA5895
70		107TA5896
73,03		107TA5897

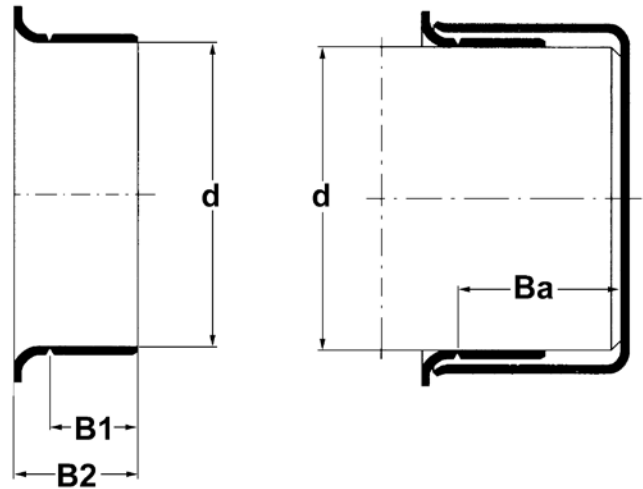

OTHER DIMENSIONS AVAILABLE

$\emptyset d$	B1	REF
75		107TA5898
76,2	20,6	107TA5899
76,2	15,9	107TA5900
79,38		107TA5901
80		107TA5902
82,55		107TA5903
82		107TA5904
84,07		107TA5905
88,9		107TA5906
90		107TA5907
91,97		107TA5908
92,08		107TA5909
95,25		107TA5910
95		107TA5911
100		107TA5912
101,6		107TA5913
107,95		107TA5914
109,93		107TA5915
111,13		107TA5916
114,3		107TA5917
120		107TA5918
120,65		107TA5919
127		107TA7678
133,35		107TA5920
152,4		107TA5921



14

HYDRAULIC PUMP UNITS



HYDRAULIC PUMP UNIT

Hydraulic scheme

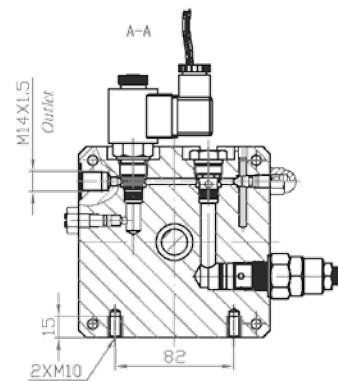
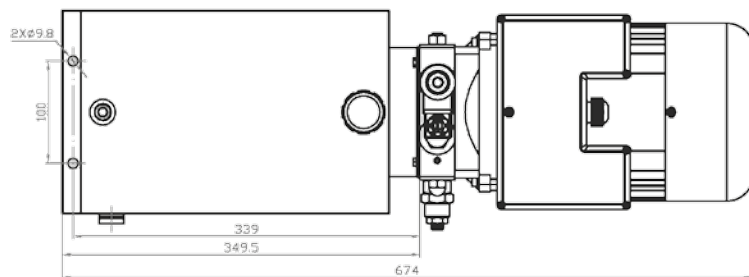
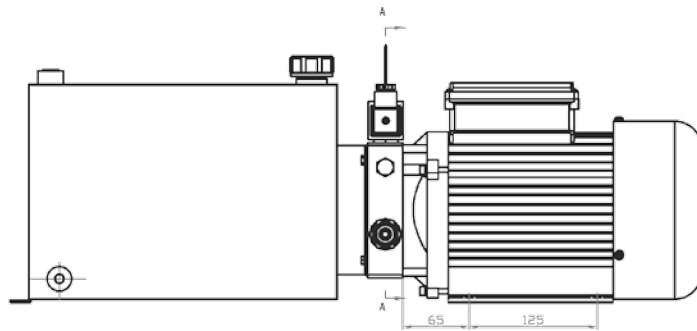
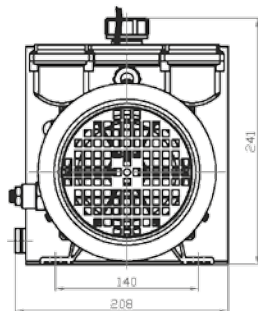
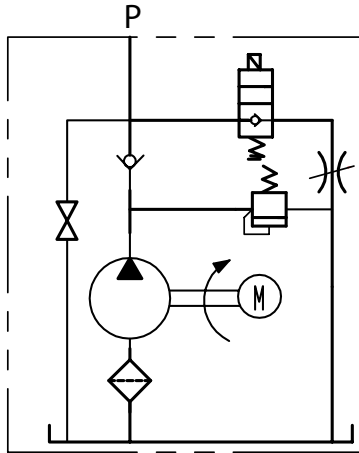

REF 141TA9958

Technical data:

- Motor: 220 VAC 2,2 kW
- Pump: 4,2 cc/r
- Relief valve: 100 bar
- Tank: 12 l/horizontally mounted



HYDRAULIC PUMP UNIT

Hydraulic scheme

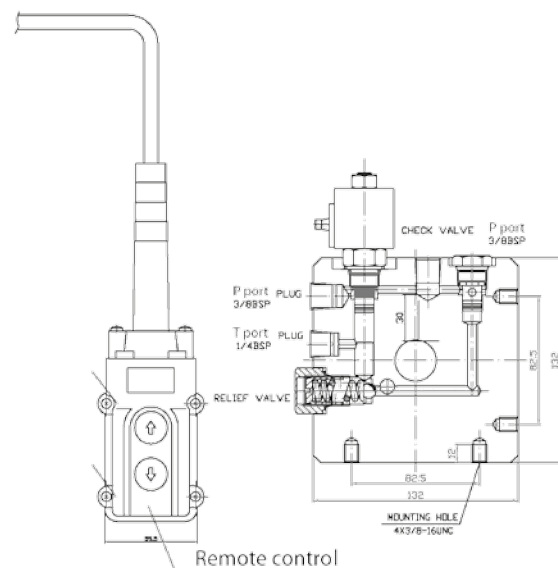
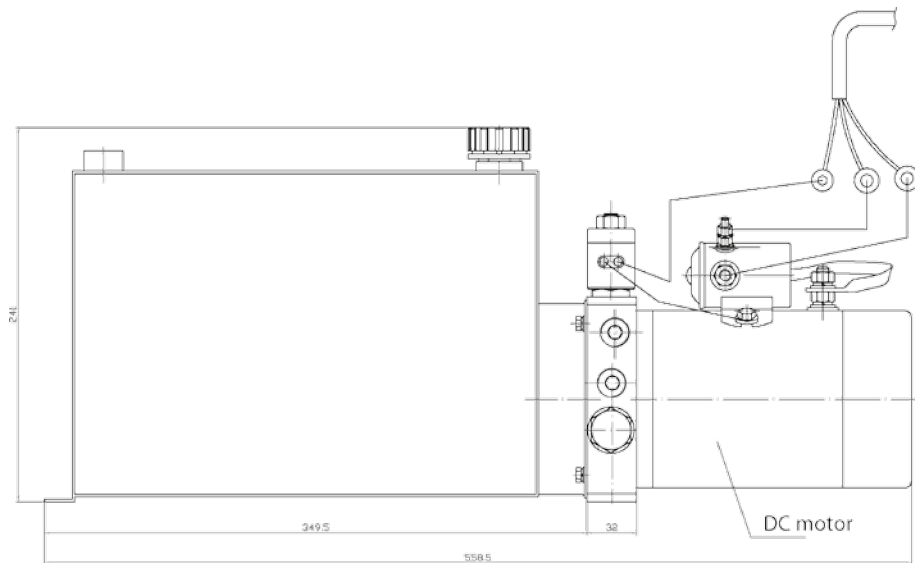
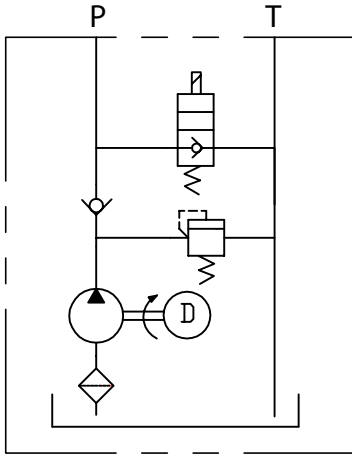

REF 141TA9957

Technical data:

- Motor: 12 VDC 1,5 kW
- Gear pump: 2,1 cc/r
- Relief valve: 200 bar
- Tank: 12 l/horizontally mounted



HYDRAULIC PUMP UNIT

Hydraulic scheme

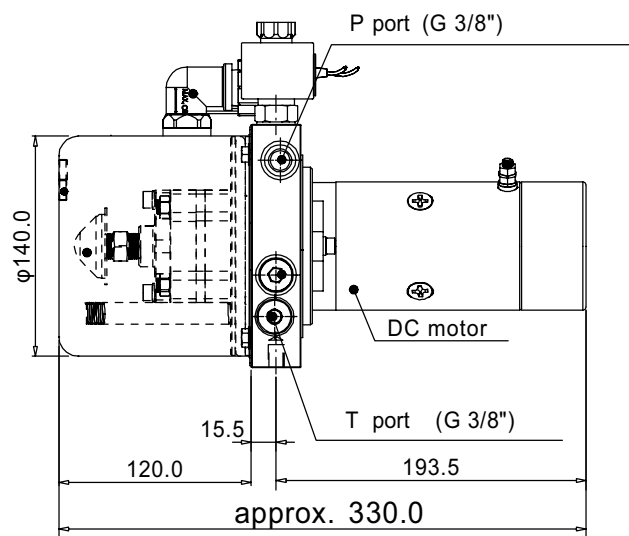
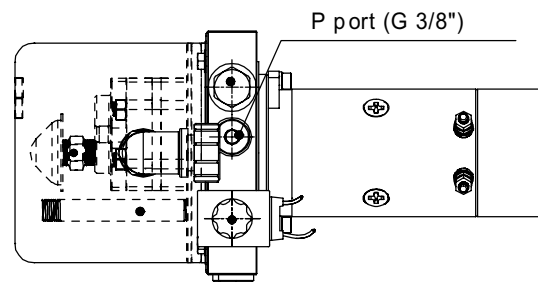
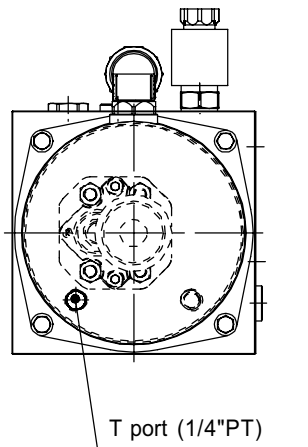
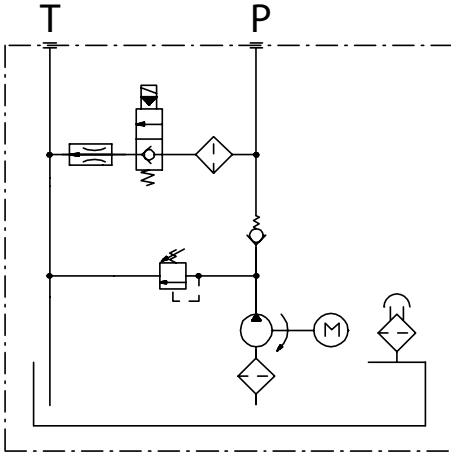

REF 141TA9959

Technical data:

- Motor: 24 VDC 0,8 kW
- Pump: 0,7 cc/r
- Relief valve: 180 bar
- Tank: 1,0 l/vertically mounted



HYDRAULIC PUMP UNIT

Hydraulic scheme

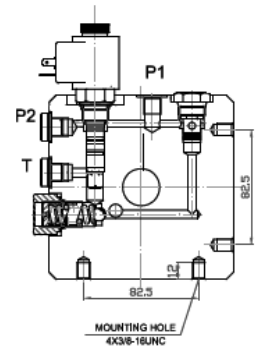
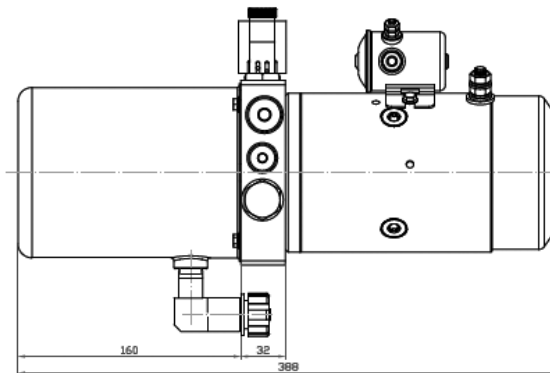
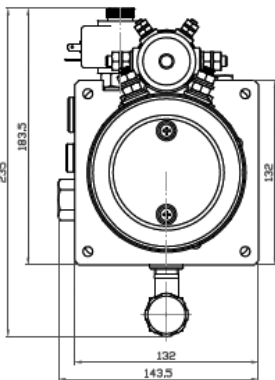
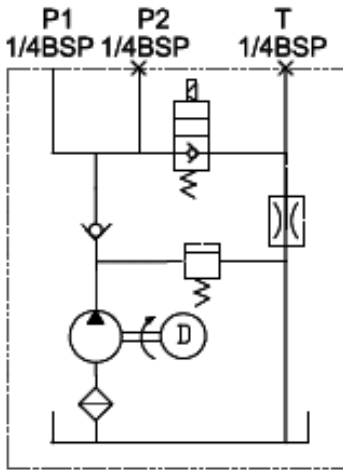

REF 163TA8823

Technical data:

- Motor: 24VDC 2,2kW
- Pump: 3,32 cc/r
- Relief valve: 175 bar
- Tank: 1,5 l/vertically mounted



HYDRAULIC PUMP UNIT

Hydraulic scheme

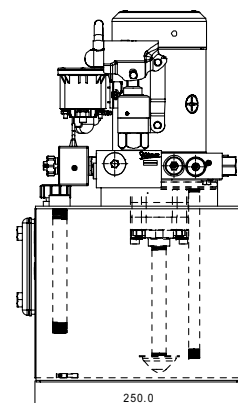
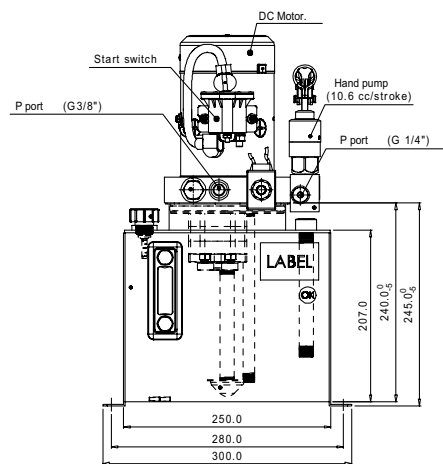
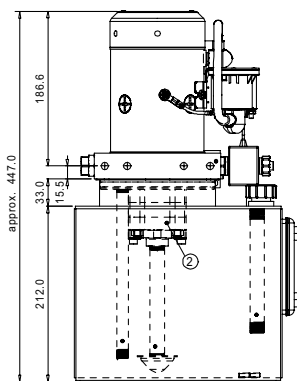
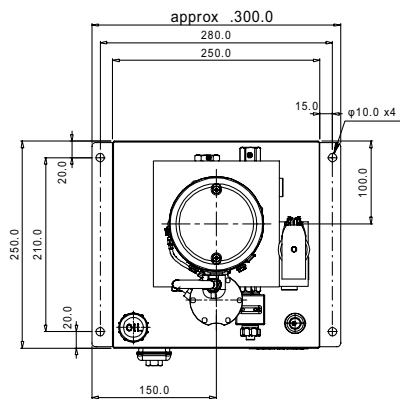
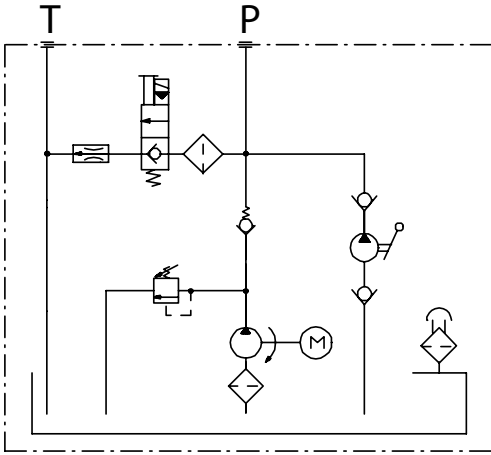

REF 141TA9960

Technical data:

- Motor: 12 VDC 1,5 kW
- Pump: 4,0 cc/r
- Hand pump: 10,6 cc/stroke
- Relief valve: 120 bar
- Tank: 12 l/vertically mounted



HYDRAULIC PUMP UNIT

Hydraulic scheme

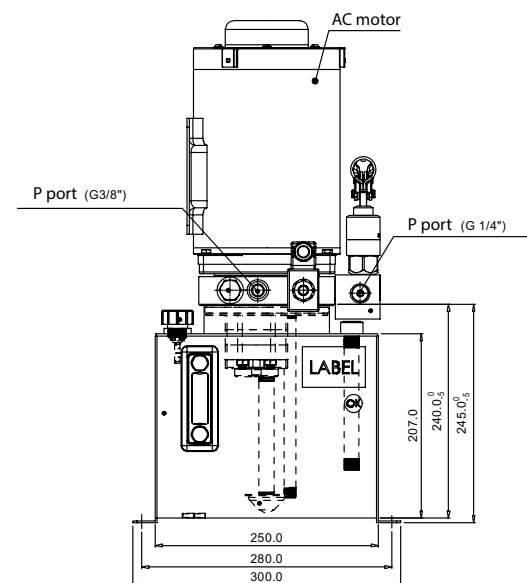
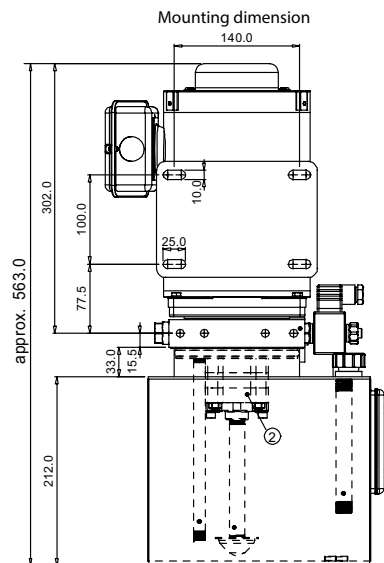
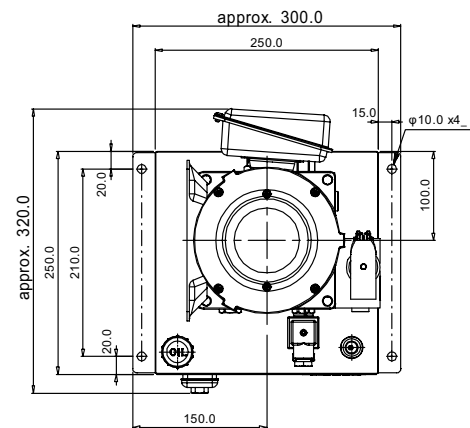
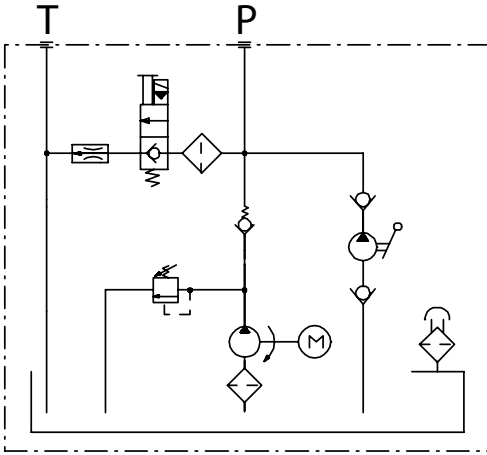

REF 141TA9961

Technical data:

- Motor: 110/220 V - 1 phase 1,5 kW
- Pump: 4,0 cc/r
- Hand pump: 10,6 cc/stroke
- Relief valve: 130 bar
- Tank: 12,0 l/vertically mounted



HYDRAULIC PUMP UNIT

Hydraulic scheme

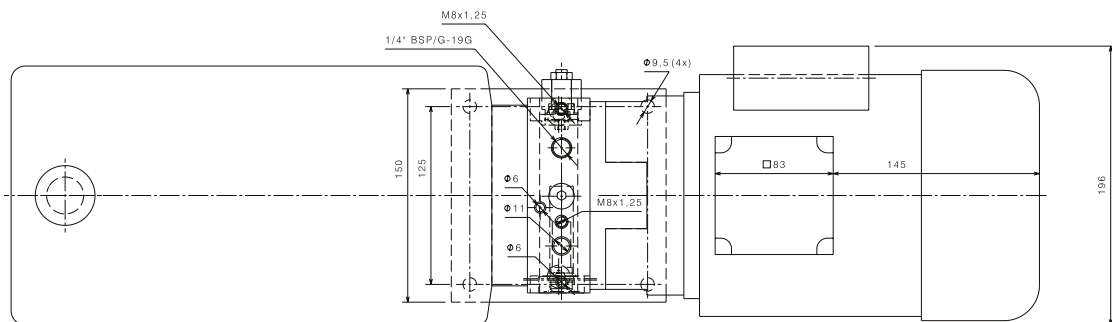
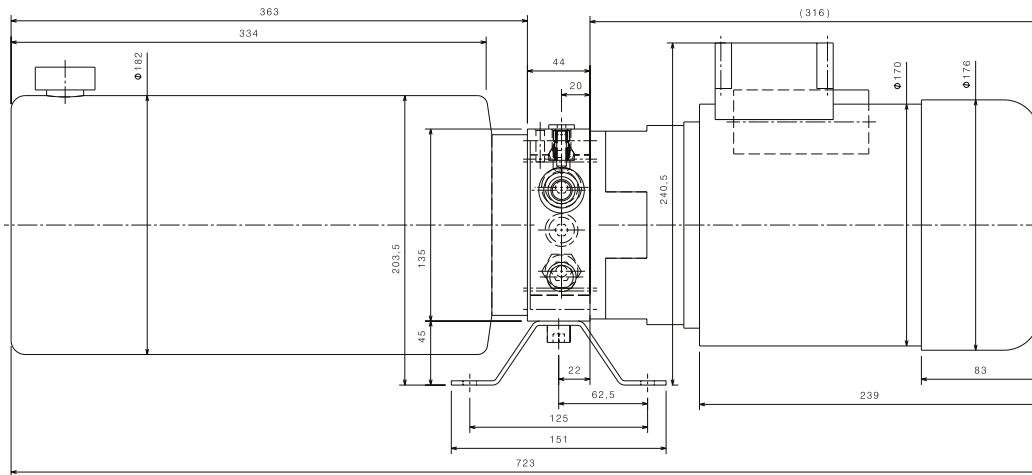
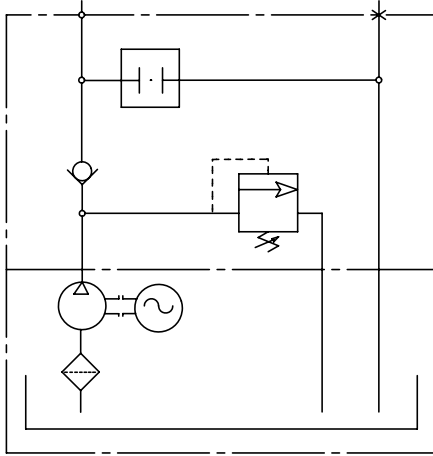

REF 141TA9962

Technical data:

- Motor: 220 VAC 1,5 kW
- Pump: 2,5 cc/r
- Relief valve: 100 bar
- Tank: 8 l/horizontally mounted



HYDRAULIC PUMP UNIT

Hydraulic scheme

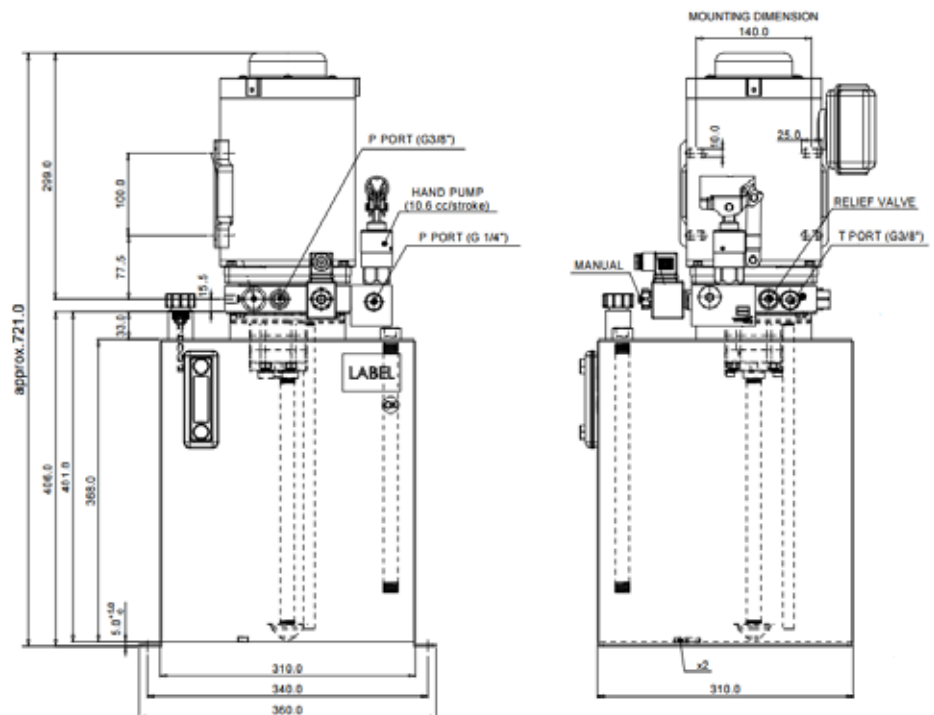
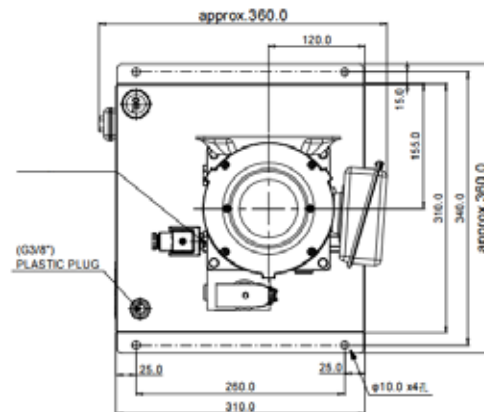
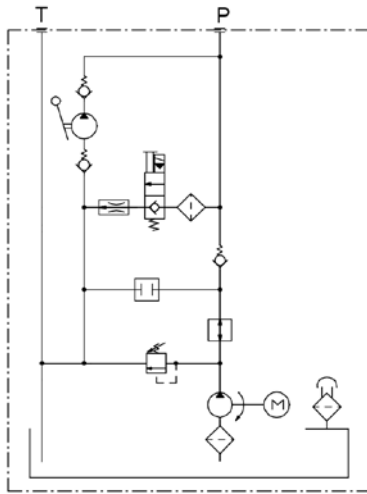

REF 152TA2767

Technical data:

- Motor: 110/220V - 1 phase 1,5kW
- Pump: 4,0 cc/r
- Hand pump: 10,6 cc/stroke
- Relief valve: 150 bar
- Tank: 30 l



HYDRAULIC UNIT



REF 107TA4364

- Used for: CLARK
- Type: CLARK ECM 20-30, EPM 20-30
- Voltage: 80 VDC

HYDRAULIC UNIT

Also available
in service exchange



REF 107TA4363

- Used for: BT
- Type: BT RT/TRT/FRT
- Voltage: 48 VDC

HYDRAULIC UNIT



REF 105TA2724

- Used for: JUNGHEINRICH
- Type: JUNGHEINRICH EKE/EKC/EJP/Kms
- Voltage: 24 VDC

HYDRAULIC UNIT



REF 152TA2043

- Used for: JUNGHEINRICH - MIC
- Type: JH EEC 10 E, JH SW 12, JH HC 10, MIC GU100MB, MIC G100MB, MIC G100B, MIC G100C, MIC G10E, MIC GU10E, MIC G10M
- Voltage: 24 VDC

HYDRAULIC UNIT



REF 107TA4368

- Used for: LINDE
- Type: LINDE E12/E14
- Voltage: 24 VDC

HYDRAULIC UNIT



REF 107TA4365

- Used for: LINDE
- Type: LINDE E12/E14, E15Z-02
- Voltage: 48 VDC



HYDRAULIC UNIT



REF 107TA4366

- Used for: LINDE
- Type: LINDE E12
- Voltage: 24 VDC

HYDRAULIC UNIT

Also available
in service exchange



REF 107TA4367

- Used for: STEINBOCK
- Type: STEINBOCK WP13/WL15
- Voltage: 24 VDC

HYDRAULIC UNIT



REF 107TA4370

- Used for: LINDE
- Type: LINDE E12
- Voltage: 24 VDC

HYDRAULIC UNIT



REF 107TA4369

- Used for: LINDE - FENWICK
- Type: FENWICK SM10/15P, FENWICK-LINDE RE16/20
- Voltage: 72 VDC



Find out more about our reconditioned parts in our brochure **REF 29127412** or go to downloads on www.tvh.com to watch the movie.



PUMP MOTORS

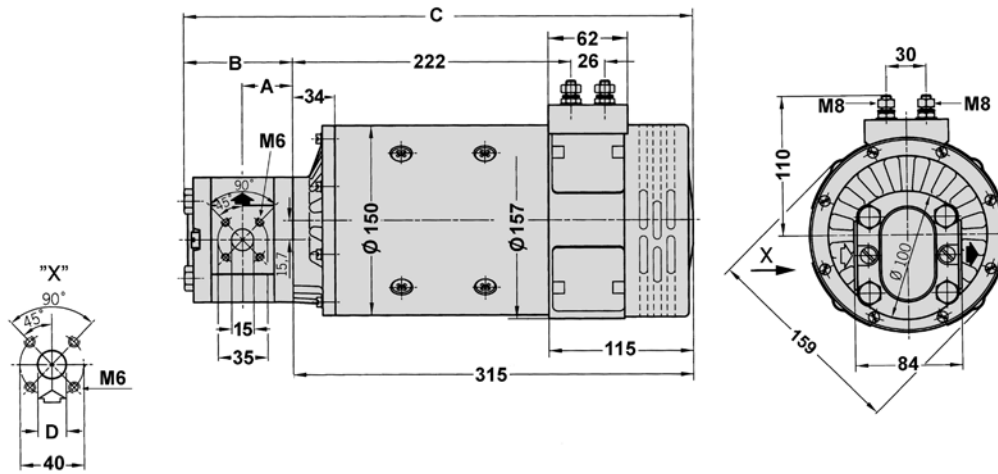

Universal application

W	V	cm ³ /rev	A	B	C	D	REF
3000	24	8	41	89	404	20	105TA2721
3000	24	11	45	94	409	20	105TA2722
3700	48	11	45	100	415	20	105TA2723

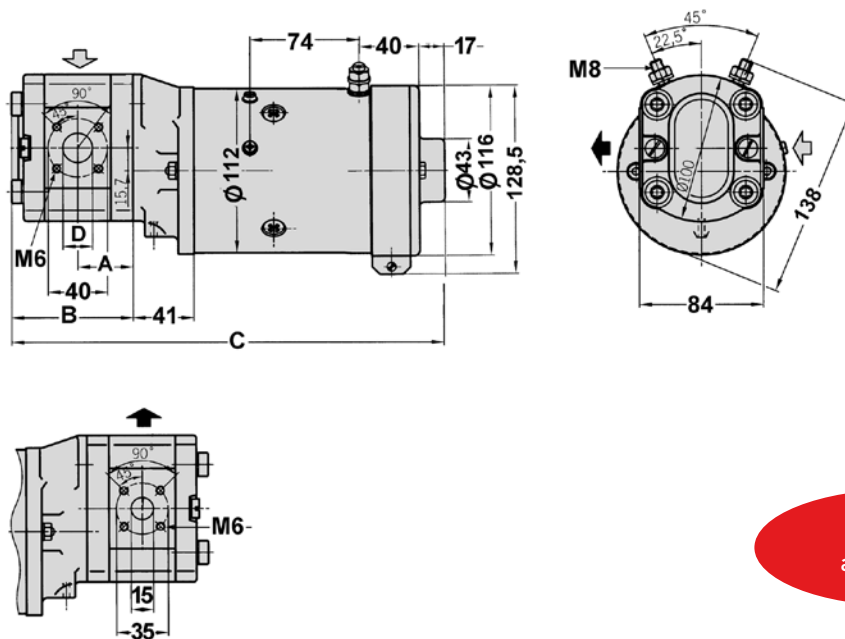

Universal application

W	V	cm ³ /rev	A	B	C	D	REF
2000	24	4	37,3	82,5	293	15	105TA2724



PUMP MOTORS

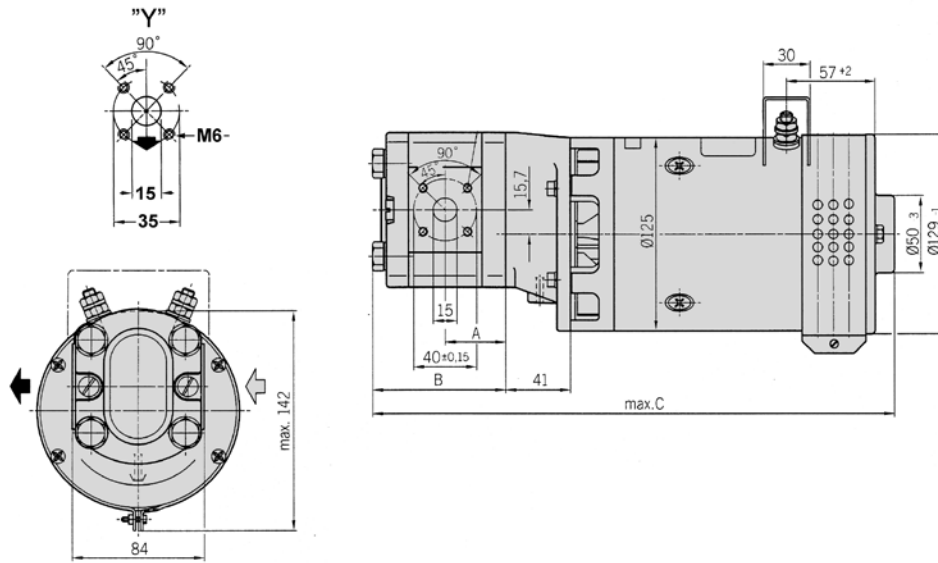

Universal application

W	V	cm ³ /rev	A	B	C	E	REF
1000	72	5,5	38,6	85	333	248	112TA4890

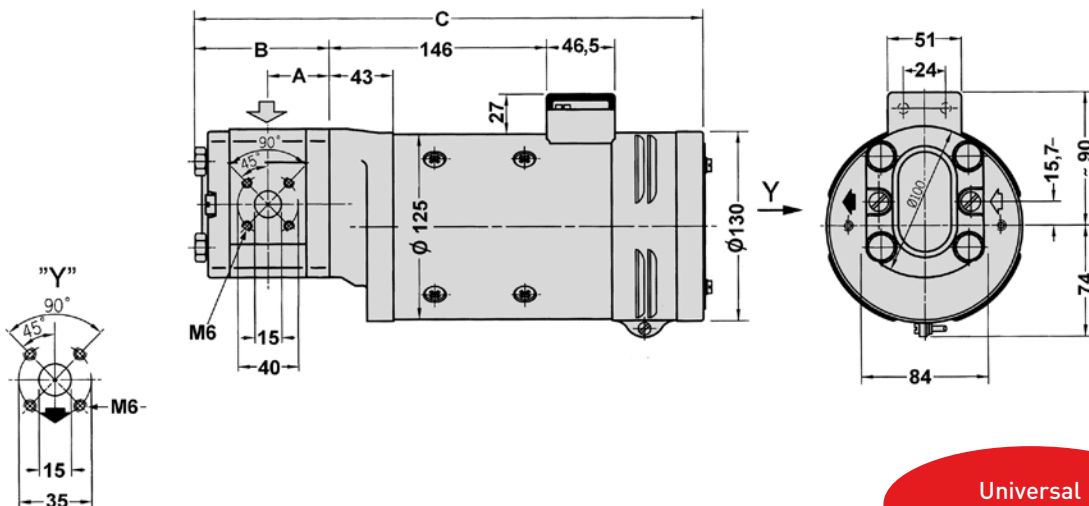

Universal application

W	V	cm ³ /rev	A	B	C	E	REF
500	72	5,5	38,6	85	340	255	105TA2726



DC HYDRAULIC POWER UNIT

DC hydraulic power unit for two single acting functions e.g. for tail gate lifts.

REF 152TA2044

- Electric motor: 2 kW
- Hydraulic circuit: 2x single acting
- Pump size: 3,2 cc/r
- Tank volume: 6,2 l
- Voltage: 12 VDC

REF 111TA6201

Voltage: 24 VDC

REF 145TA8547

Voltage: 48 VDC

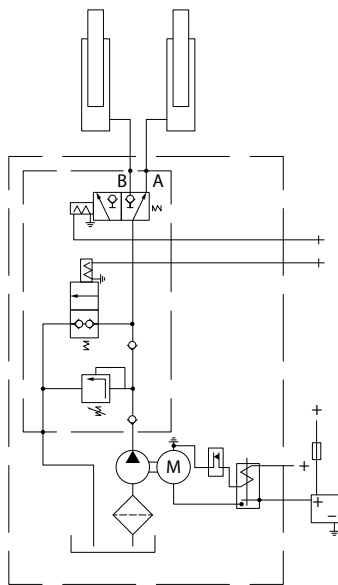

DC hydraulic power unit for mixed double and single acting functions e.g. for tail gate lifts.

REF 152TA2046

- Electric motor: 2 kW
- Pump size: 2,6 cc/r
- Tank volume: 9,8 l
- Voltage: 12 VDC

Tail gate lift with:

- A. Single acting lifting cylinders
- B. Double acting tilting cylinders

Operations:

1. Lifting (pump power up)
2. Lowering (gravity down)
3. Tilt close (pump power close)
4. Tilt open (pump power open)

Note:

Relief valve setting has to be examined and adjusted to lift construction

Operation overview:

- Operation: activate solenoid
- Up: R + Y1
- Down: Y2
- Tilt up close: R + Y1 + Y3
- Tilt down open: R + Y2 + Y3

REF 145TA8548

Voltage: 24 VDC

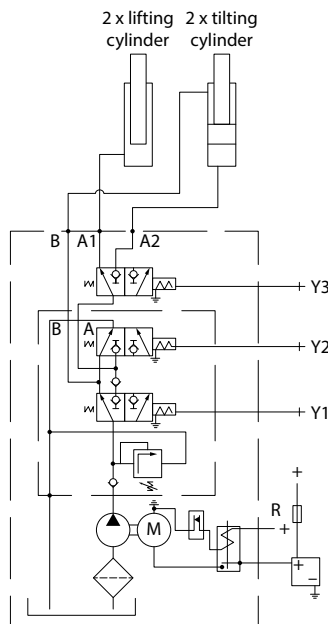



TECHNICAL DETAIL: HYDRAULIC PUMP UNITS

The technical sheet can help us to find the pump you need

Group
03-10-01-00



Customer details

Type machine:

Price inquiry

Serial n° machine:

Order

CODE: TY-PG x L1 x B1 x H1 x FT-HYG x AC/DC x U1 x U2 x I x N x P x KS x DRZ1 x S1 x S2 x S3 x ST-REL x U3 x Q1 x BAR x CAP x TY-FL x AT-EL x DRZ2 x D1 x TA1 x D2 x TA2 x D3 x TA3 x D4 x TA4 x LIT x L2 x B2 x H2 x D5 x HV x DCP x U4 x TY-VA x TY-CI x D6 x Q2 x FV

.....

- TY-PG Type of pump group:
A = motor-pump-reservoir
B = motor-pump
C = motor-pump / in housing with reservoir
- L1 Overall length, see according to type.
- B1 Overall width, see according to type.
- H1 Overall height, see according to type.
- FT-HYG Function of the pump group:
H = lift
R = drive
S = steering
- AC/DC AC = alternating current motor.
 DC = direct current motor.
- U1 Lowest tension of the motor (Volt).
- U2 Highest tension of the motor (Volt).
- I Current (Ampere).
- N Revolutions per minute.
- P Power (kW). If stated in horsepower, ratio HP-KW is 0,736 (e.g.: 1HP = 0,736 kW).
- KS Cooling fan present: YES/NO.



TECHNICAL DETAIL: HYDRAULIC PUMP UNITS

- DRZ1..... Direction of rotation motor:
CW = clockwise
CCW = counterclockwise
- S1..... Cycle of operation S1: continuous operation, see identification plate.
- S2..... Cycle of operation S2: brief operation, see identification plate.
- S3..... Cycle of operation S3: intermittent operation, see identification plate.
- ST-REL Starter relay present: YES/NO.
- U3 Tension starter relay (Volt), if present.
- Q1 Flow of the hydraulic pump, in l/min.
- BAR Pressure in bar.
- CAP Capacity of the pump: number of cc per revolution.
- TY-FL..... Type of flange of the hydraulic pump, see figures.
- AT-EL Number of pump elements.
- DRZ2..... Direction of rotation hydraulic pump:
CW = clockwise
CCW = counterclockwise
- D1 Diameter suction side 1st element.
- TA1 Thread type suction side 1st element.
- D2 Diameter pressure side 1st element.
- TA2 Thread type pressure side 1st element.
- D3 Diameter suction side 2nd element.
- TA3 Thread type suction side 2nd element.
- D4 Diameter pressure side 2nd element.
- TA4 Thread type pressure side 2nd element.
- LIT Capacity of the reservoir, in litre.
- L2..... Length of the reservoir.
- B2..... Width of the reservoir.
- H2 Height of the reservoir.
- D5 Diameter of the reservoir.
- HV Position (if a reservoir is present):
H = horizontal
V = vertical



TECHNICAL DETAIL: HYDRAULIC PUMP UNITS



- DCP Decompression:
Z = without
M = manual
E = electric

- U4 Tension of the valve (Volt), if electrical decompression.

- TY-VA Type of valve:
VNF = normally closed valve
VNO = normally opened valve
VLB = directional logical valve

- TY-CI Type cilinder:
S = single-acting (one gate)
D = double-acting (two gates)

- D6 Diameter of the lowering choke.

- Q2 Flow of the lowering choke, in l/min.

- FV Lowering choke proportional with pump: YES/NO.

TYPES

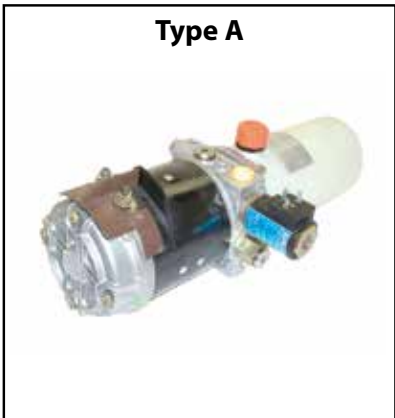



TECHNICAL DETAIL: HYDRAULIC PUMP UNITS

DIMENSIONS

Type A

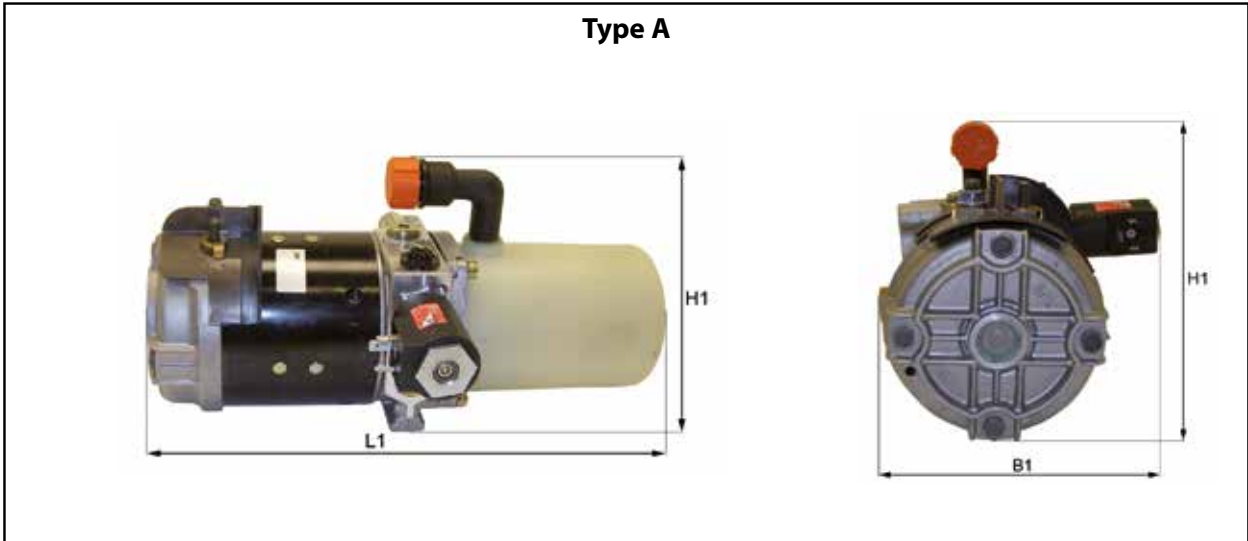

Type B

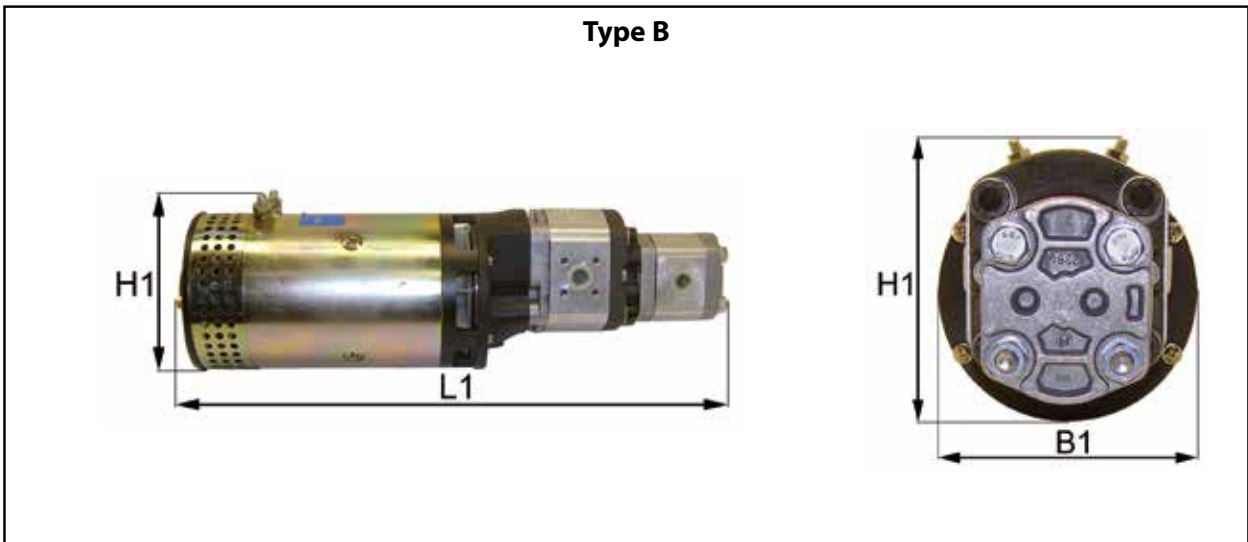

Type C

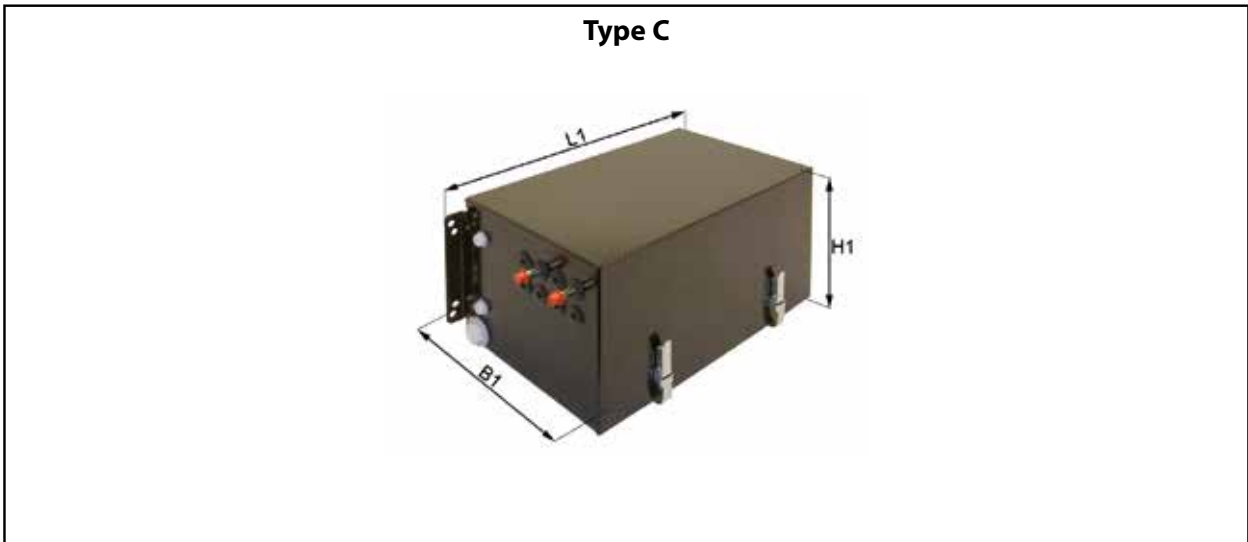



TECHNICAL DETAIL: HYDRAULIC PUMP UNITS

TYPE OF FLANGE

Type A (A)

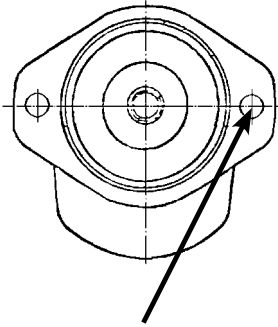

If thread = type AA.

Type B

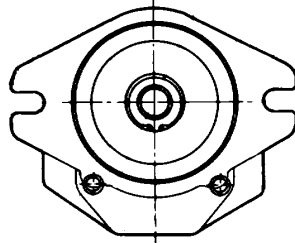

Type C

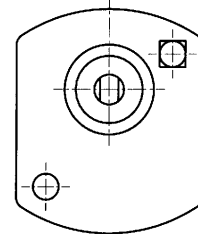

Type D

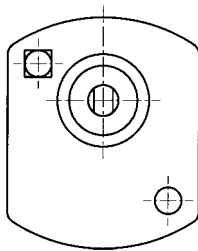

Type E

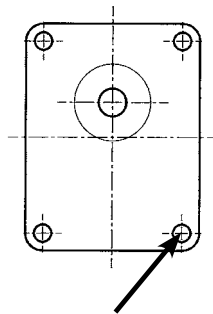

Also possible with a random shape.

Type F

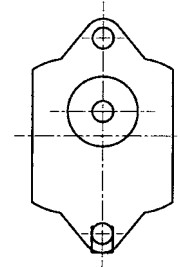

Type G

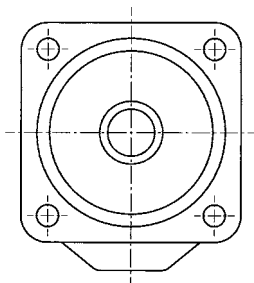

Type H

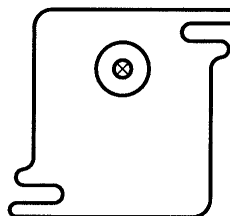

Type I

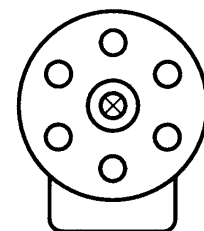

Type S

Special types:
none of the above.



TECHNICAL DETAIL: HYDRAULIC PUMP UNITS

DIRECTION OF ROTATION MOTOR

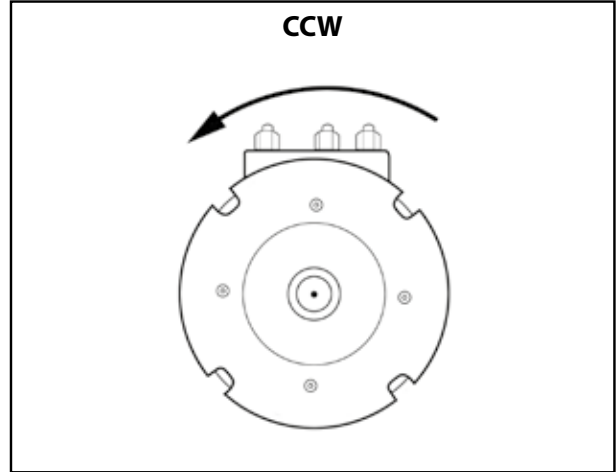
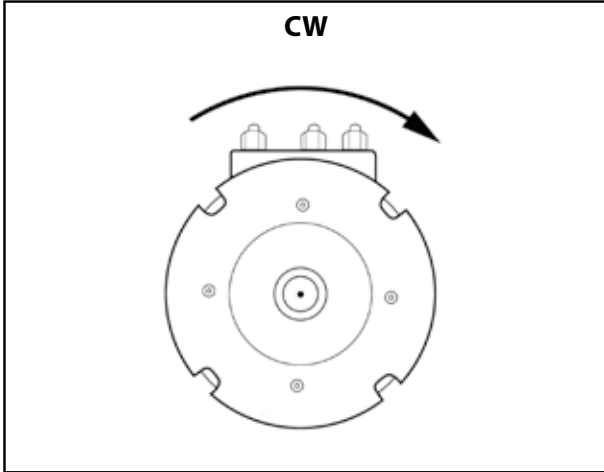

STARTER RELAY

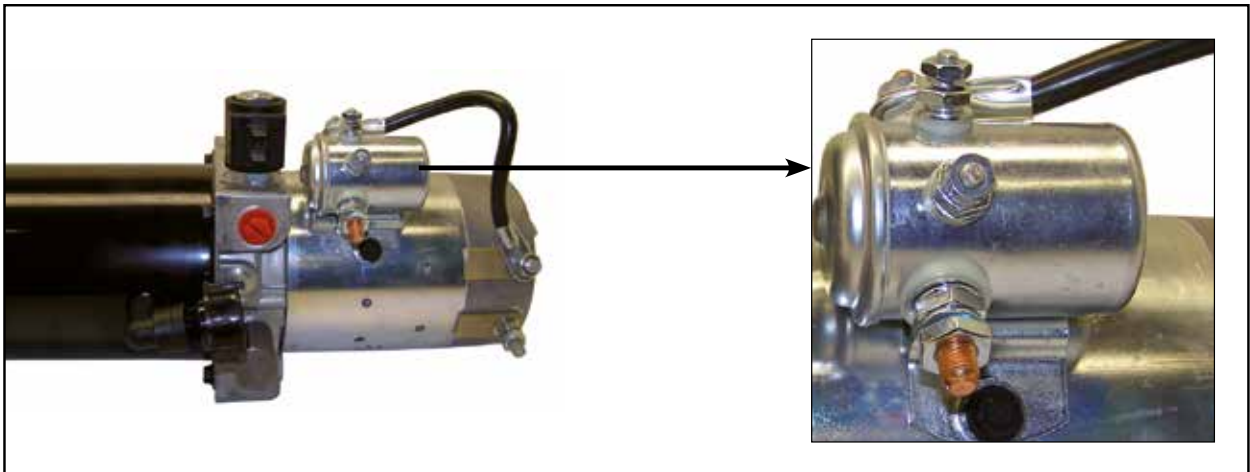

NUMBER OF ELEMENTS

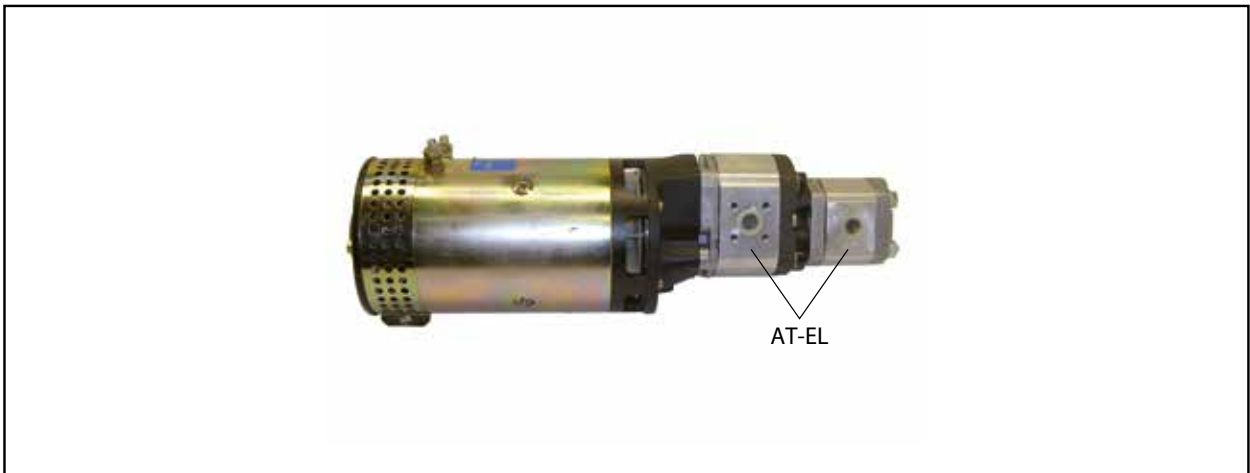



TECHNICAL DETAIL: HYDRAULIC PUMP UNITS

DIRECTION OF ROTATION HYDRAULIC PUMP

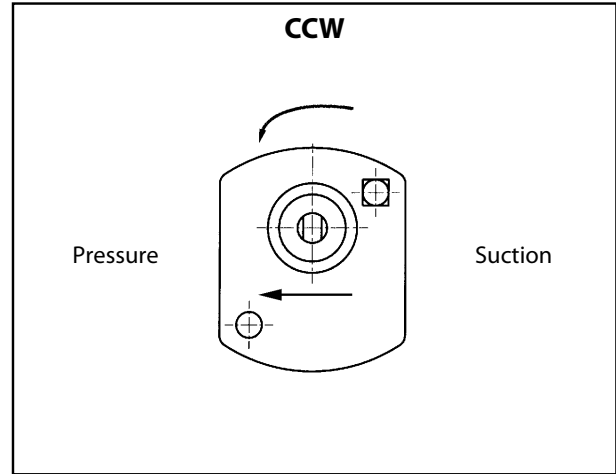
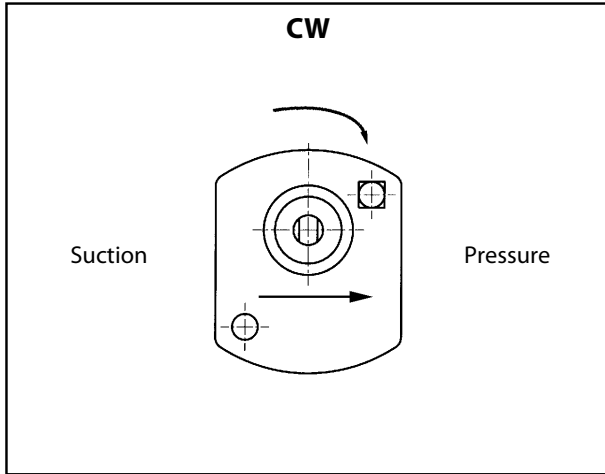

DIMENSIONS RESERVOIR

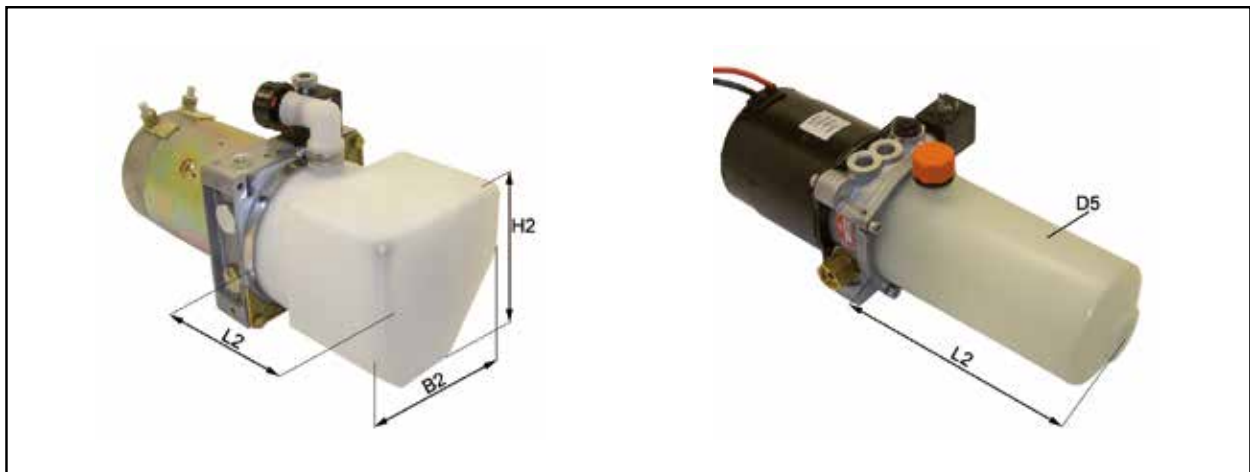

POSITION

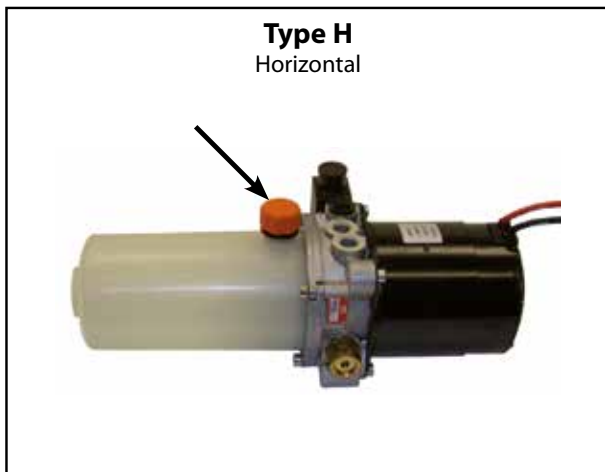



TECHNICAL DETAIL: HYDRAULIC PUMP UNITS

DECOMPRESSION

Manual

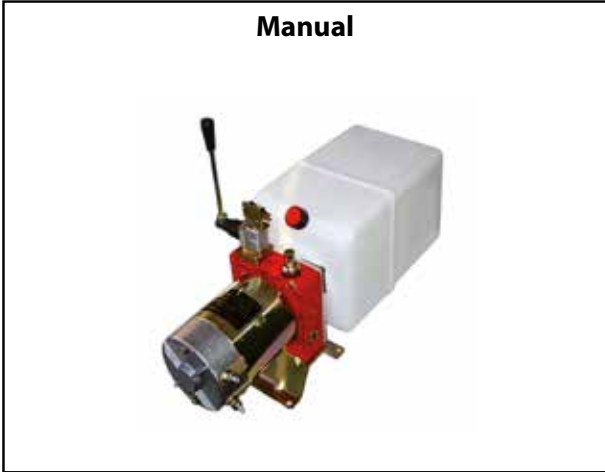

Electrical

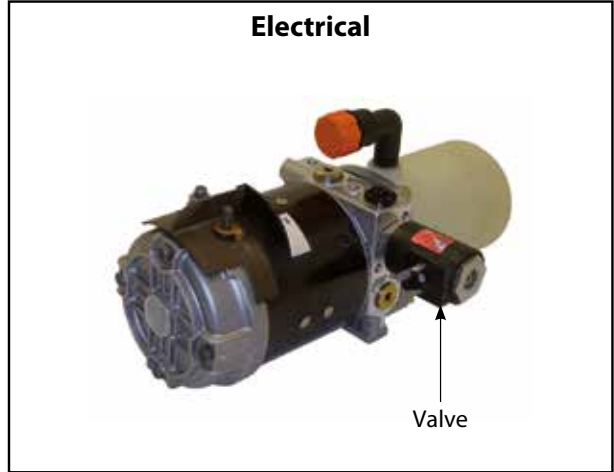

TYPE OF CYLINDER

Type S
Single-acting



Type D
Double-acting





TECHNICAL DETAIL: HYDRAULIC PUMP UNITS

Groep
03-10-01-00



Gegevens klant

Type machine:
 Serienr. machine:

Prijsaanvraag
 Bestelling

CODE: TY-PG x L1 x B1 x H1 x FT-HYG x AC/DC x U1 x U2 x I x N x P x KS x DRZ1 x S1 x S2 x S3 x ST-REL x U3 x Q1 x BAR x CAP x TY-FL x AT-EL x DRZ2 x D1 x TA1 x D2 x TA2 x D3 x TA3 x D4 x TA4 x LIT x L2 x B2 x H2 x D5 x HV x DCP x U4 x TY-VA x TY-CI x D6 x Q2 x FV



- TY-PG Type pompgroep:
A = motor-pomp-tank
B = motor-pomp
C = motor-pomp / in behuizing met tank
- L1 Maximale lengte, zie volgens type.
- B1 Maximale breedte, zie volgens type.
- H1 Maximale hoogte, zie volgens type.
- FT-HYG. Functie v/d pompgroep:
H = heffen
R = rijden
S = sturen
- AC/DC AC = wisselstroommotor.
 DC = gelijkstroommotor.
- U1 Laagste spanning van de motor (Volt).
- U2 Hoogste spanning van de motor (Volt).
- I Stroom (Ampere).
- N Toeren per minuut.
- P Vermogen (kW). Indien vermeld in horse power, verhouding HP-KW is 0,736 (vb: 1HP = 0,736 kW).
- KS Koelschroef aanwezig: JA/NEE.

zie Engelse technische fiche !



TECHNICAL DETAIL: HYDRAULIC PUMP UNITS

- DRZ1..... Draaizin motor:
CW = wijzerzin
CCW = tegenwijzerzin
- S1..... Werkingcyclus S1: continu bedrijf, zie identificatieplaat.
- S2..... Werkingcyclus S2: kortstondig bedrijf, zie identificatieplaat.
- S3..... Werkingcyclus S3: intermitterend bedrijf, zie identificatieplaat.
- ST-REL Start relais aanwezig: JA/NEE.
- U3 Spanning start relais (Volt), indien aanwezig.
- Q1 Debiet van de hydraulische pomp, in l/min.
- BAR Druk in bar.
- CAP Capaciteit van de pomp: aantal cc per omwenteling.
- TY-FL..... Type flens van de hydraulische pomp, zie figuren.
- AT-EL Aantal pompelementen.
- DRZ2..... Draaizin hydraulische pomp:
CW = wijzerzin
CCW = tegenwijzerzin
- D1 Diameter aanzuigzijde 1ste element.
- TA1 Draadsoort aanzuigzijde 1ste element.
- D2 Diameter perszijde 1ste element.
- TA2 Draadsoort perszijde 1ste element.
- D3 Diameter aanzuigzijde 2de element.
- TA3 Draadsoort aanzuigzijde 2de element.
- D4 Diameter perszijde 2de element.
- TA4 Draadsoort perszijde 2de element.
- LIT Inhoud van de tank, in liter.
- L2..... Lengte van de tank.
- B2..... Breedte van de tank.
- H2 Hoogte van de tank.
- D5 Diameter van de tank.
- HV Positie (als een tank aanwezig is):
H = horizontaal
V = verticaal

zie Engelse technische fiche !



TECHNICAL DETAIL: HYDRAULIC PUMP UNITS

- DCP Decompressie:
Z = zonder
M = manueel
E = elektrisch
- U4 Spanning van de ventiel (Volt), indien elektrische decompressie.
- TY-VA Type ventiel:
VNF = normally closed valve
VNO = normally opened valve
VLB = directional logical valve
- TY-CI Type cilinder:
S = enkelwerkend (een poort)
D = dubbelwerkend (twee poorten)
- D6 Diameter daalsmoring.
- Q2 Debiet van de daalsmoring, in l/min.
- FV Daalsmoring proportioneel met pomp: JA/NEE.

TYPES

Type A

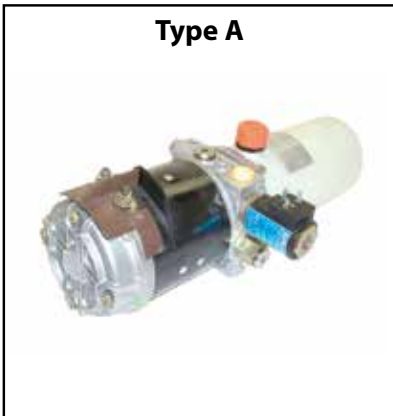

Type B



Type C



zie Engelse technische fiche !



TECHNICAL DETAIL: HYDRAULIC PUMP UNITS

Groupe
03-10-01-00

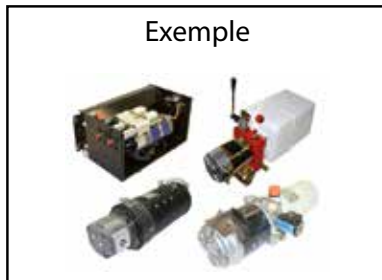

Données client

Type machine :

Demande de prix

No. série machine :

Commande

CODE : TY-PG x L1 x B1 x H1 x FT-HYG x AC/DC x U1 x U2 x I x N x P x KS x DRZ1 x S1 x S2 x S3 x ST-REL x U3 x Q1 x BAR x CAP x TY-FL x AT-EL x DRZ2 x D1 x TA1 x D2 x TA2 x D3 x TA3 x D4 x TA4 x LIT x L2 x B2 x H2 x D5 x HV x DCP x U4 x TY-VA x TY-CI x D6 x Q2 x FV



- TY-PG Type de groupe hydraulique :
A = moteur-pompe-réservoir
B = moteur-pompe
C = moteur-pompe / dans boîtier avec réservoir
- L1 Longueur totale, voir selon type.
- B1 Largeur totale, voir selon type.
- H1 Hauteur totale, voir selon type.
- FT-HYG. Fonction du groupe hydraulique :
H = levage
R = traction
S = direction
- AC/DC AC = moteur a courant alternatif.
 DC = moteur a courant continu.
- U1 Tension minimale du moteur (Volt).
- U2 Tension maximale du moteur (Volt).
- I Ampérage.
- N Tours/minute.
- P Puissance (kW). Si l'indication est en horse power, la proportion HP-KW est de 0,736 (ex : 1 HP = 0,736 kW).
- KS Hélice de refroidissement présente: OUI/NON.

voir la fiche technique en Anglais.



TECHNICAL DETAIL: HYDRAULIC PUMP UNITS

- DRZ1..... Sens de rotation :
CW = sens des aiguilles
CCW = sens inverse des aiguilles
- S1..... Mode de fonctionnement S1 : service continu, voir plaque d'identification.
- S2..... Mode de fonctionnement S2 : service temporaire, voir plaque d'identification.
- S3..... Mode de fonctionnement S3 : service intermittent, voir plaque d'identification.
- ST-REL Relais de démarrage présent : OUI/NON.
- U3 Tension du relais de démarrage (Volt), si présent.
- Q1 Débit de la pompe hydraulique, en l/min.
- BAR Pression en bar.
- CAP Capacité de la pompe : cc/tour
- TY-FL..... Type de bourrelet de la pompe hydraulique.
- AT-EL Nombre d'éléments de pompe.
- DRZ2..... Sens de rotation :
CW = sens des aiguilles
CCW = sens inverse des aiguilles
- D1 Diamètre du côté apport premier élément.
- TA1 Type de filetage côté apport premier élément.
- D2 Diamètre du côté pression premier élément.
- TA2 Type de filetage côté pression premier élément.
- D3 Diamètre du côté apport deuxième élément.
- TA3 Type de filetage côté apport deuxième élément.
- D4 Diamètre du côté pression deuxième élément.
- TA4 Type de filetage côté pression deuxième élément.
- LIT Contenance du réservoir, en litre.
- L2..... Longueur du réservoir.
- B2..... Largeur du réservoir.
- H2 Hauteur du réservoir.
- D5 Diamètre du réservoir.

voir la fiche technique en Anglais.



TECHNICAL DETAIL: HYDRAULIC PUMP UNITS

- HV Position (si présence de réservoir) :
H = horizontal
V = vertical
- DCP Décompression :
Z = sans
M = manuelle
E = électrique
- U4 Tension de la valve (Volt), si la décompression est électrique.
- TY-VA Type de valve :
VNF = nvalve normalement fermée
VNO = valve normalement ouverte
VLB = valve logique bidirectionnelle
- TY-CI Type de cylindre :
S = simple effet (une porte)
D = double effet (deux portes)
- D6 Diamètre du freineur de débit.
- Q2 Débit du freineur, en l/min.
- FV..... Freineur de débit proportionnel a la pompe : OUI/NON.

TYPES

Type A

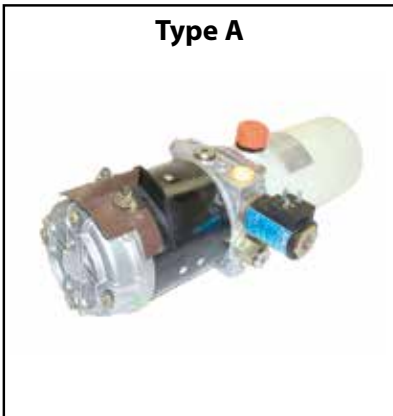

Type B

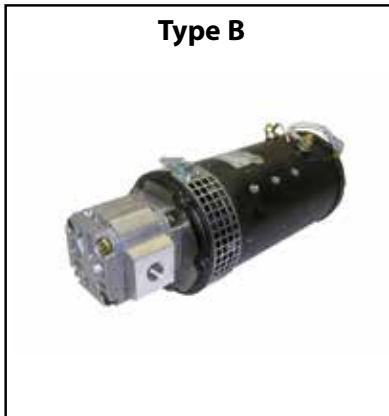

Type C



voir la fiche technique en Anglais.



TECHNICAL DETAIL: HYDRAULIC PUMP UNITS

Gruppe
03-10-01-00



Kundendaten

Maschinentyp:
 Serien-Nr. Maschine:

Preis Anfrage
 Bestellung

CODE: TY-PG x L1 x B1 x H1 x FT-HYG x AC/DC x U1 x U2 x I x N x P x KS x DRZ1 x S1 x S2 x S3 x
 ST-REL x U3 x Q1 x BAR x CAP x TY-FL x AT-EL x DRZ2 x D1 x TA1 x D2 x TA2 x D3 x TA3 x
 D4 x TA4 x LIT x L2 x B2 x H2 x D5 x HV x DCP x U4 x TY-VA x TY-CI x D6 x Q2 x FV



- TY-PG Typ Pumpengruppe:
A = Motor - Pumpe - Tank
B = Motor - Pumpe
C = Motor - Pumpe / in Gehäuse mit Tank
- L1 Länge, siehe gem. Typ.
- B1 Breite, siehe gem. Typ.
- H1 Höhe, siehe gem. Typ.
- FT-HYG. Funktion der Pumpengruppe:
H = Heben
R = Fahren
S = Lenken
- AC/DC AC = Wechselstrommotor.
 DC = Gleichstrommotor.
- U1 Niedrigste Spannung des Motors (Volt).
- U2 Höchste Spannung des Motors (Volt).
- I Strom (Ampere).
- N Touren pro Minute.
- P Leistung (kW). Falls vermeldet in PS, Verhältnis PS-kW ist 0,736 (z.B. 1PS = 0,736 kW).
- KS Kühlschraube vorhanden: JA/NEIN.

Siehe technische Datenblätter auf Englisch.



TECHNICAL DETAIL: HYDRAULIC PUMP UNITS

- DRZ1..... Drehrichtung Motor:
CW = Im Uhrzeigersinn
CCW = Gegen den Uhrzeigersinn
- S1..... Arbeitszyklus S1: Dauerbetrieb, siehe Identifikationsschild.
- S2..... Arbeitszyklus S2: Kurzer Betrieb, siehe Identifikationsschild.
- S3..... Arbeitszyklus S3: Betrieb mit Unterbrechungen, siehe Identifikationsschild.
- ST-REL Startrelais vorhanden: JA/NEIN.
- U3 Spannung Startrelais (Volt), falls vorhanden.
- Q1 Fördermenge der Hydraulikpumpe, in L/Min.
- BAR Druck in Bar.
- CAP Kapazität der Pumpe: Anzahl cc pro Umdrehung.
- TY-FL..... Flanschtyp der Hydraulikpumpe, siehe Abbildungen.
- AT-EL Anzahl Pumpenelemente.
- DRZ2..... Drehrichtung Hydraulikpumpe:
CW = Im Uhrzeigersinn
CCW = Gegen den Uhrzeigersinn
- D1 Durchmesser Ansaugseite 1. Element.
- TA1 Gewindeart Ansaugseite 1. Element.
- D2 Durchmesser Druckseite 1. Element.
- TA2 Gewindeart Druckseite 1. Element.
- D3 Durchmesser Ansaugseite 2. Element.
- TA3 Gewindeart Ansaugseite 2. Element.
- D4 Durchmesser Druckseite 2. Element.
- TA4 Gewindeart Druckseite 2. Element.
- LIT Tankinhalt, in Liter.
- L2..... Tanklänge
- B2..... Tankbreite.
- H2 Tankhöhe.
- D5 Tankdurchmesser.
- HV Position (falls ein Tank vorhanden ist):
H = Horizontal
V = Vertikal

Siehe technische Datenblätter auf Englisch.



TECHNICAL DETAIL: HYDRAULIC PUMP UNITS

- DCP Dekompression:
Z = Ohne
M = Manuell
E = Elektrisch
- U4 Ventilspannung (Volt), bei elektrischer Dekompression.
- TY-VA Ventiltyp:
VNF = normally closed valve
VNO = normally opened valve
VLB = directional logical valve
- TY-CI Zylindertyp:
S = Einfach (ein Anschluss)
D = Doppelt (zwei Anschlüsse)
- D6 Durchmesser Drosselventil.
- Q2 Fördermenge des Drosselventils, in L/Min.
- FV Drosselventil proportional mit Pumpe: JA/NEIN.

TYPEN

Typ A

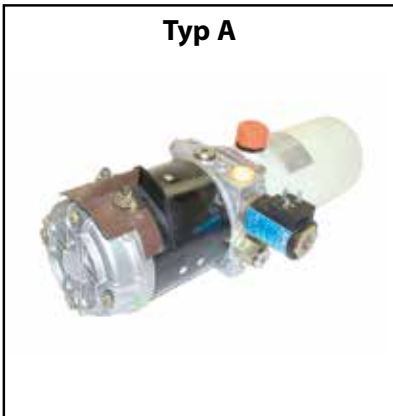

Typ B



Typ C



Siehe technische Datenblätter auf Englisch.



15

HYDRAULIC GENERATORS



HYDRAULIC GENERATOR

Tired of hauling around a generator for your power tools?

The new hydraulic generator from TVH doesn't need to be carried. This hydraulic, compact and easy-to-install power supply will help you do your job at any height with all your small and heavy power tools.

This generator can be connected to the hydraulic circuits of aerial work platforms, earth-moving equipment, trucks, cranes and other construction machines.



Advantages

- **High-quality** product
- Compact size and easy to install
- No need for an external power supply and thus no extra costs
- **Safe working**, no cable reels hanging around
- AVR (Automatic Voltage Regulation): makes sure your **voltage stays stable** under all circumstances
- Start/stop function results in a **longer life span of your generator**
- All references can be used on machines equipped with a fixed displacement main pump or with a load sensing pump
- All required certificates available

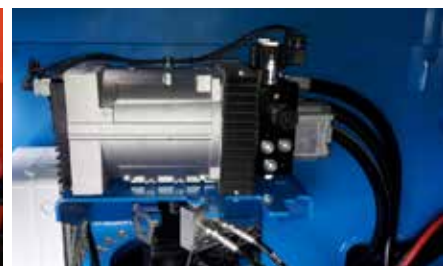



HYDRAULIC GENERATOR



TOTALSOURCE®

REF	Electrical characteristics					Hydraulic characteristics				
	Power (kVA)	Voltage (V)	Frequency (Hz)	On-off valve (VDC)	AVR (Regulation range)	Flow min-max (l/min)	Ideal flow (l/min)	Pressure min-max (bar)	Back pressure (bar)	Oil temp. (max) (°C)
<u>161TA8411</u>	4,2	230	50	12	+/-2%	30-45	35	150-210	8	70
<u>163TA8603</u>	4,2	230	50	12	+/-2%	15-30	18	150-210	8	70
<u>163TA8604</u>	4,2	230	50	24	+/-2%	30-45	35	150-210	8	70
<u>163TA8605</u>	4,2	230	50	24	+/-2%	15-30	18	150-210	8	70
<u>163TA8748</u>	5,2	110	60	12	+/-2%	25-30	27	150-210	8	70
<u>163TA8749</u>	5,2	110	60	24	+/-2%	25-30	27	150-210	8	70

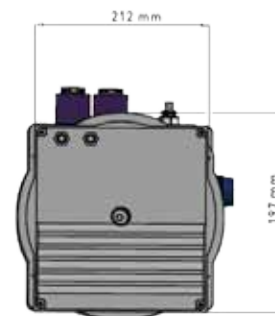
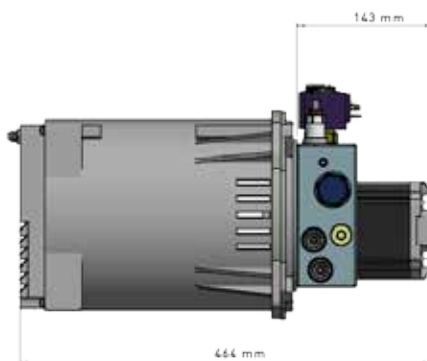



16

HYDRAULIC HOSES & ACCESSORIES





TECHNICAL DETAIL: HYDRAULIC HOSES

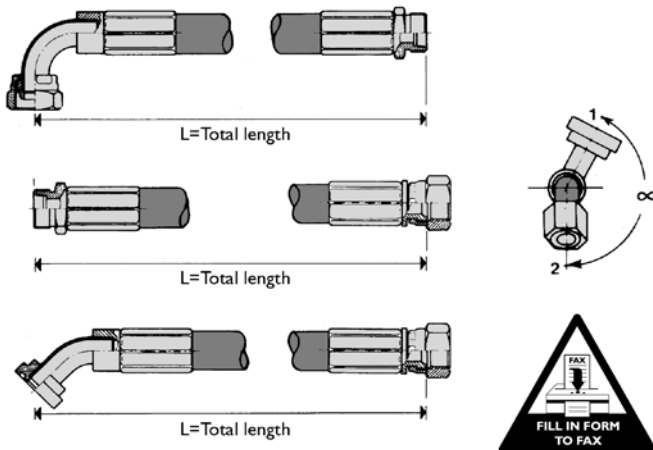

Company:

Customer code:

Name:

Fax number:

Truck make:

Truck type: Serial nr.:

EXAMPLE

A) Type of hose
2 Din 20022 2SN (R2AT) 3/8 dia.

B) Left side:
3 Metric M20 x 1,5 dia. m/fem female straight 45° 90°

C) Right side:
4 JIC 3/4 dia. m/fem male straight 45° 90°

D) Total length of hose: 3850 mm



A) Type of hose

1 Din 20022 1SN (R1AT)	diameter
2 Din 20022 2SN (R2AT)	diameter
3 SAE 100 R9A	diameter
4 SAE 100 R7	diameter
5 SAE 100 R7 Twin	diameter

B) Left side: Type of fitting:

	dia.	m/fem	straight	45°	90°
1 BSP
2 NPT
3 Metric
4 Jic
5 Banjo
6 ORFS
7 DKOL
8 DKOS

C) Right side: Type of fitting:

	dia.	m/fem	straight	45°	90°
1 BSP
2 NPT
3 Metric
4 Jic
5 Banjo
6 ORFS
7 DKOL
8 DKOS

D) Total length of hose mm



IN 20022 1SN/EN853 1SN ISO 1436 SAE J 517 (100R1AT) ISO1436



Please indicate
reference + length in meter

Inside Ø			Outside Ø		Work. press.		Min. burst press.		Min. bend radius		REF
mm	DN	Inch	mm	Inch	bar	PSI	bar	PSI	mm	Inch	
4,8	5	3/16	11,8	0,47	250	3650	1000	14600	90	3,54	111TA3997
6,4	6	1/4	13,4	0,53	225	3250	900	13050	100	3,90	107TA3413
7,9	8	5/16	15	0,59	215	3100	850	12350	115	4,50	107TA3414
9,5	10	3/8	17,4	0,69	180	2600	720	10450	130	5,10	111TA3998
12,7	12	1/2	20,6	0,81	160	2300	640	9300	180	7,10	107TA3416
15,9	16	5/8	23,7	0,93	130	1900	520	7550	200	7,90	107TA3417
19	19	3/4	27,7	1,09	105	1500	420	6000	240	9,50	111TA3999
25,4	25	1"	35,6	1,4	88	1300	350	5200	300	11,80	111TA4000
31,8	31	1" 1/4	43,5	1,71	63	900	250	3650	420	16,50	111TA4001
38,1	38	1" 1/2	50,1	1,97	50	725	200	2900	500	19,70	111TA4002
50,8	51	2"	63,5	2,5	40	580	160	2300	630	24,80	131TA6904

IN 20022 2SN/EN853 2SN ISO 1436 SAE J 517 (100R2AT) ISO1436



Please indicate
reference + length in meter

Inside Ø			Outside Ø		Work. press.		Min. burst press.		Min. bend radius		REF
mm	DN	Inch	mm	Inch	bar	PSI	bar	PSI	mm	Inch	
4,8	5	3/16	13,7	0,53	415	6000	1650	23950	90	3,55	131TA6905
6,4	6	1/4	15	0,59	400	5800	1600	23200	100	4,00	131TA6906
7,9	8	5/16	16,6	0,65	350	5100	1400	20300	115	4,55	131TA6907
9,5	10	3/8	19	0,75	330	4800	1320	19150	130	5,10	131TA6908
12,7	12	1/2	22,2	0,87	275	4000	1100	15950	180	7,10	131TA6909
15,9	16	5/8	25,4	1,00	250	3600	1000	14500	200	7,90	131TA6910
19	19	3/4	29,3	1,15	215	3100	850	12350	240	9,45	131TA6911
25,4	25	1"	38,1	1,50	165	2400	650	9450	300	11,80	131TA6912
31,8	31	1" 1/4	48,3	1,90	125	1800	500	7250	420	16,50	131TA6913
38,1	38	1" 1/2	55	2,17	90	1300	360	5250	500	19,70	131TA6914
50,8	51	2"	67	2,67	80	1150	320	4650	630	24,80	131TA6915



HYDRAULIC HOSE: 1SC - EN 857



Please indicate
reference + length in meter

Inside Ø			Outside Ø		Work. press.		Min. burst press.		Min. bend radius		REF
mm	DN	Inch	mm	Inch	bar	PSI	bar	PSI	mm	Inch	
6,4	6	1/4	13	0,51	275	4000	1100	16000	45	1,77	131TA6916
7,9	8	5/16	14	0,55	255	3700	1020	14800	55	2,16	131TA6917
9,5	10	3/8	16,4	0,65	215	3100	860	12500	60	2,36	131TA6918
12,7	12	1/2	19,5	0,77	170	2470	680	9900	70	2,75	131TA6919
15,9	16	5/8	22,6	0,89	150	2180	600	8700	90	3,54	131TA6920
19	19	3/4	26,2	1,03	125	1820	500	7250	100	3,94	131TA6921
25,4	25	1"	34	1,34	100	1450	400	5800	160	6,30	131TA6922

HYDRAULIC HOSE: 2SC - EN 857



Please indicate
reference + length in meter

Inside Ø			Outside Ø		Work. press.		Min. burst press.		Min. bend radius		REF
mm	DN	Inch	mm	Inch	bar	PSI	bar	PSI	mm	Inch	
6,4	6	1/4	13,6	0,54	420	6100	1680	24400	50	1,97	131TA6923
7,9	8	5/16	15,2	0,60	380	5500	1520	22100	60	2,36	131TA6924
9,5	10	3/8	17,5	0,69	350	5100	1400	20300	70	2,76	131TA6925
12,7	12	1/2	20,9	0,82	290	4250	1160	16850	80	3,15	131TA6926
15,9	16	5/8	24	0,94	260	3800	1040	15100	100	3,94	131TA6927
19	19	3/4	27,8	1,09	220	3200	880	12800	140	5,51	131TA6928
25,4	25	1"	35,6	1,40	170	2500	680	9900	180	7,09	131TA6929



MEDIUM PRESSURE HOSE: (SAE 100R7)



Please indicate
reference + length in meter

Inside Ø		Outside Ø		Work. press.		Min. burst press.		Min. bend radius		REF
mm	Inch	mm	Inch	bar	PSI	bar	PSI	mm	Inch	
4,8	3/16	10,9	0,43	207	3000	827	12000	19	3/4	131TA6930
6,4	1/4	13,0	0,52	207	3000	827	12000	32	1" 1/4	107TA3426
7,9	5/16	15,1	0,60	172	2500	689	10000	44	1" 3/4	107TA3427
9,5	3/8	16,8	0,66	155	2250	620	9000	51	2	107TA3428
12,7	1/2	20,8	0,82	138	2000	552	8000	76	3	107TA3429
19	3/4	27,2	1,07	69	1250	345	5000	127	5	107TA3430

MEDIUM PRESSURE HOSE: TWIN (SAE 100R7)



Please indicate
reference + length in meter

Inside Ø		Outside Ø		Work. press.		Min. burst press.		Min. bend radius		REF
mm	Inch	mm	Inch	bar	PSI	bar	PSI	mm	Inch	
4,8	3/16	10,9	0,43	207	3000	827	12000	19	3/4	107TA3420
6,4	1/4	13	0,52	207	3000	827	12000	32	1" 1/4	131TA6931
7,9	5/16	15,1	0,6	172	2500	689	10000	44	1" 3/4	131TA6932
9,5	3/8	16,8	0,66	155	2250	620	9000	51	2	131TA6933
12,7	1/2	20,8	0,82	138	2000	552	8000	76	3	131TA6934
19	3/4	27,2	1,07	69	1250	345	5000	127	5	131TA6935



HIGH PRESSURE HOSE: (SAE 100R8)



Please indicate
reference + length in meter

Inside Ø			Outside Ø		Work. press.		Min. burst press.		Min. bend radius		REF
mm	DN	Inch	mm	Inch	bar	PSI	bar	PSI	mm	Inch	
4,8	5	3/16	10,9	0,43	345	5000	1380	20000	38	1,50	133TA7821
6,4	6	1/4	13	0,51	345	5000	1380	20000	51	2,00	133TA7822
7,9	8	5/16	14,5	0,57	310	4500	1240	18000	64	2,52	133TA7823
9,5	10	3/8	16,5	0,65	275	4000	1100	16000	64	2,52	133TA7824
12,7	12	1/2	20,6	0,81	240	3500	960	14000	102	4,02	133TA7825
15,9	16	5/8	23,4	0,92	190	2750	760	11000	152	5,98	133TA7826
19,1	20	3/4	28,9	1,14	155	2250	620	9000	165	6,5	133TA7827
25,4	25	1"	37,4	1,47	138	2000	552	8000	254	10	133TA7828

HIGH PRESSURE HOSE: TWIN (SAE 100R8)



Please indicate
reference + length in meter

Inside Ø			Outside Ø		Work. press.		Min. burst press.		Min. bend radius		REF
mm	DN	Inch	mm	Inch	bar	PSI	bar	PSI	mm	Inch	
4,8	5	3/16	10,9	0,43	345	5000	1380	20000	38	1,50	133TA7829
6,4	6	1/4	13	0,51	345	5000	1380	20000	51	2,00	133TA7830
7,9	8	5/16	14,5	0,57	310	4500	1240	18000	64	2,52	133TA7831
9,5	10	3/8	16,5	0,65	275	4000	1100	16000	64	2,52	133TA7832
12,7	12	1/2	20,6	0,81	240	3500	960	14000	102	4,02	133TA7833



SUCTION AND RETURN LINE HOSE (SAE 100R4)



Please indicate
reference + length in meter

Inside Ø		Outside Ø		Work. press.		Min. burst press.		Min. bend radius		REF
mm	Inch	mm	Inch	bar	PSI	bar	PSI	mm	Inch	
19,1	3/4	30,0	1,18	20,7	300	83	1200	65	2,56	131TA6936
25,4	1"	38,0	1,50	17,2	250	68,9	1000	75	2,95	131TA6937
31,8	1" 1/4	45,0	1,77	13,8	200	55,2	800	100	3,94	131TA6938
38,1	1" 1/2	52,0	2,05	10,3	150	41,4	600	130	5,12	131TA6939
50,8	2"	64,0	2,52	6,9	100	27,6	400	150	5,91	131TA6940

SUCTION AND RETURN LINE HOSE - HIGH TEMP RANGE (SAE 100R4)



Please indicate
reference + length in meter

Inside Ø		Outside Ø		Work. press.		Min. burst press.		Min. bend radius		REF
mm	Inch	mm	Inch	bar	PSI	bar	PSI	mm	Inch	
19,1	3/4	30,0	1,18	20,7	300	83	1200	38	1,50	131TA6941
25,4	1"	38,0	1,5	17,2	250	68,9	1000	50	2,00	131TA6942
31,8	1" 1/4	45,0	1,77	13,8	200	55,2	800	64	2,50	131TA6943
38,1	1" 1/2	52,0	2,05	10,3	150	41,4	600	76	3,00	131TA6944
50,8	2"	63,0	2,52	6,9	100	27,6	400	102	4,00	131TA6945



SAE 100 R6- EN 854 R6 HOSE



Please indicate
reference + length in meter

Inside Ø		Outside Ø		Work. press.		Min. burst press.		Min. bend radius		REF
mm	Inch	mm	Inch	bar	PSI	bar	PSI	mm	Inch	
6	1/4	12,7	0,50	27,6	400	110,3	1600	64	2,6	131TA6946
8	5/16	14,3	0,56	27,6	400	110,3	1600	76	3,0	131TA6947
10	3/8	15,9	0,63	27,6	400	110,3	1600	76	3,0	131TA6948
13	1/2	19,8	0,78	27,6	400	110,3	1600	102	4,1	131TA6949
16	5/8	23,0	0,91	24,1	350	96,5	1400	107	4,3	131TA6950
19	3/4	26,9	1,06	20,7	300	82,8	1200	152	6,1	131TA6951
25	1"	33,4	1,31	17,2	250	69,0	1000	203	8,1	131TA6952

SAE 100 R9R



Please indicate
reference + length in meter

Inside Ø			Outside Ø		Work. press.		Min. burst press.	Min. bend radius	REF
mm	DN	Inch	mm	Inch	bar	PSI	bar	mm	
6,4	6	1/4	17,2	18,4	500	7250	1800	150	111TA4006
9,5	10	3/8	20,6	22,2	445	6455	1780	180	107TA3401
12,7	12	1/2	23,8	25,4	425	6165	1700	230	107TA3402
15,9	16	5/8	27,7	29,3	350	5075	1560	250	111TA4007
19	19	3/4	31,2	32,8	350	5075	1540	300	107TA3403
25,4	25	1"	38,5	40,9	320	4640	1280	340	107TA3404
32	31	1"1/4	46,3	48,7	210	3045	960	460	111TA4008
38	38	1"1/2	52,3	54,7	185	2685	840	560	111TA4009



STEEL PROTECTIVE COIL SPRING

Inner Ø	REF per m	Inner Ø	REF per m
13 mm	106TA6464	26 mm	106TA6470
15 mm	106TA6465	29 mm	106TA6471
17 mm	106TA6466	33 mm	106TA6472
19 mm	106TA6467	41 mm	106TA6473
21 mm	106TA6468	48 mm	106TA6474
23 mm	106TA6469	54 mm	106TA6475



STEEL PROTECTIVE COIL SPRING

Inner Ø	Wire thickness	REF per m	Inner Ø	Wire thickness	REF per m
14 mm	2 mm	116TA6121	30 mm	3 mm	116TA6128
18 mm	2 mm	116TA6122	34 mm	3 mm	116TA6129
20 mm	2 mm	116TA6123	41 mm	3 mm	116TA6130
23 mm	2 mm	116TA6124	48 mm	3 mm	116TA6131
25 mm	2 mm	116TA6125	51 mm	3 mm	116TA6132
27 mm	2 mm	116TA6126	52 mm	3 mm	116TA6133
27 mm	2,5 mm	116TA6127	54 mm	3 mm	116TA6134



STEEL PROTECTIVE COIL SPRING

Inner Ø	REF/piece
18,5 mm	106TA6448
22,3 mm	106TA6449
25,5 mm	106TA6450
29,3 mm	106TA6451
34,2 mm	106TA6452
42 mm	106TA6453
53,1 mm	106TA6454



length ± 20 cm

PLASTIC PROTECTIVE COIL SLEEVE

Inner Ø	REF per m	Inner Ø	REF per m
7 mm	106TA6455	25 mm	106TA6460
9 mm	106TA6456	30 mm	106TA6461
13 mm	106TA6457	40 mm	106TA6462
16 mm	106TA6458	50 mm	106TA6463
20 mm	106TA6459		





CLAMPS FOR HYDRAULIC HOSES

Diameter	Width	REF
10 mm	20 mm	106TA2810
12 mm	15 mm	163TA8698
15 mm	15 mm	106TA2812
16 mm	20 mm	106TA2813
18 mm	12 mm	106TA2814
18 mm	18 mm	106TA2815
20 mm	15 mm	106TA2816
20 mm	25 mm	106TA2817
30 mm	22 mm	106TA2818
40 mm	20 mm	106TA2819
66 mm	25 mm	106TA2820



PROTECTIVE SLEEVES

Textile protection

Flat width	For hose	REF per m
35	1/4"	116TA5759
40	3/8"	116TA5760
45		116TA5761
50		116TA5762
55	1/2" - 5/8"	116TA5763
65	3/4"	116TA5764
80	1"	116TA5765
120		116TA5766
150		116TA5767

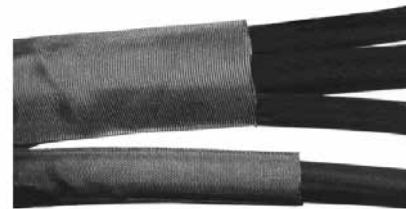

SLEEVE FOR TEXTILE PROTECTION

D1	L	REF
22 mm	30 mm	163TA8699
27 mm	30 mm	163TA8700
32 mm	30 mm	163TA8701
38 mm	30 mm	163TA8702
46 mm	30 mm	163TA8703

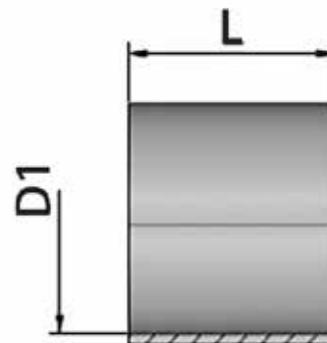



HEAT-RESISTANT PROTECTIVE SLEEVES

Outer dia. mm	Inner dia.		Weight kg/m	REF per m
	Nominal mm	Minimum mm		
35,1	25,4	24,3	0,49	<u>116TA5773</u>
40,4	31,8	30,7	0,55	<u>116TA5774</u>
44,5	34,9	34,2	0,65	<u>116TA5775</u>
48,3	38,1	37,1	0,71	<u>116TA5776</u>
52,3	44,4	43,4	0,55	<u>116TA5777</u>







STEEL PIPES (HIGH-PRESSURE)

Type: Seamless cold drawn high-pressure pipe in conformity with DIN 2445/2.
 Material: Steel ST. 35.4. Mat. no. 1.0309.
 Finish: Blank glown as per NBK-norm, internally and externally phosphated against corrosion and oiled, 100% tested for pressure, stamped and plugged at the ends
 Lengths: Sold per metre











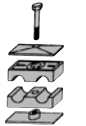
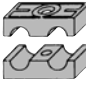

		Working pressure	Proof pressure	Burst pressure	REF
mm	mm	bar	bar	bar	
4	0,5	266	404	953	107TA8616
6	1	377	558	1320	107TA8617
6	1,5	565	792	2145	107TA8618
8	1	282	430	953	107TA8619
8	1,5	424	619	1514	107TA8620
8	2	565	792	2145	107TA8621
10	1	239	370	746	107TA8622
10	1,5	359	538	1170	107TA8623
10	2	479	694	1634	107TA8624
12	1	199	308	612	107TA8625
12	1,5	299	455	953	107TA8626
12	2	399	591	1320	107TA8627
14	1,5	256	394	804	107TA8628
14	2	342	514	1107	107TA8629
15	1,5	239	370	746	107TA8630
15	2	319	483	1024	107TA8631
16	1,5	224	347	695	107TA8632
16	2	299	455	953	107TA8633
16	2,5	374	558	1225	107TA8634
16	3	449	656	1514	107TA8635
18	1,5	199	308	612	107TA8674
18	2	266	408	837	107TA8636
18	3	399	591	1320	107TA8637
20	1,5	179	277	547	107TA8638
20	2	239	370	746	107TA8639
20	2,5	299	455	953	107TA8640
20	3	359	538	1170	107TA8641
20	4	479	694	1634	107TA8642
22	1,5	163	252	495	107TA8643
22	2	217	336	673	107TA8644
22	2,5	272	417	858	107TA8645
22	3	326	493	1050	107TA8646
25	2	191	296	586	107TA8647
25	2,5	239	370	746	107TA8648
25	3	287	438	912	107TA8649
25	4	399	495	1259	107TA8650
28	1,5	128	198	384	107TA8651
28	2	171	264	520	107TA8652
28	3	256	394	804	107TA8653
30	2	159	246	483	107TA8654
30	2,5	199	308	612	107TA8655
30	3	239	370	746	107TA8656
30	4	333	504	1024	107TA8657
30	5	416	617	1320	107TA8658
35	2	142	220	411	107TA8659
35	2,5	178	275	520	107TA8660
35	3	214	331	631	107TA8661
38	2,5	164	254	476	107TA8662
38	3	197	305	578	107TA8663
38	4	263	405	789	107TA8664
38	5	328	498	1009	107TA8665
42	2	119	183	339	107TA8666
42	3	171	264	520	107TA8667
42	4	238	367	707	107TA8668
42	5	297	454	903	107TA8669
50	5	249	386	746	107TA8670
50	6	299	457	911	107TA8671
60	6	249	386	746	107TA8672
60	8	333	504	1024	107TA8673









PIPE BRACKETS

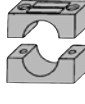

					
Dia tube (mm)	REF	REF	REF	REF	REF
6	107TA3629	107TA3562	107TA3519	107TA3509	107TA3498
6,35	107TA3630	107TA3563	107TA3519	107TA3509	107TA3498
7,93	107TA3631	107TA3564	107TA3519	107TA3509	107TA3498
8	107TA3632	107TA3565	107TA3519	107TA3509	107TA3498
9,52	107TA3633	107TA3566	107TA3519	107TA3509	107TA3498
10	107TA3634	107TA3567	107TA3519	107TA3509	107TA3498
12	107TA3635	107TA3568	107TA3519	107TA3509	107TA3498
12,7 (M6)	107TA3636	107TA3569	107TA3519	107TA3509	107TA3498
12,7 (M8)	107TA3637	107TA3570	107TA3519	107TA3510	107TA3499
13,25	107TA3638	107TA3571	107TA3520	107TA3510	107TA3499
14	107TA3639	107TA3572	107TA3520	107TA3510	107TA3499
15,87	107TA3641	107TA3574	107TA3520	107TA3510	107TA3499
16	107TA3642	107TA3573	107TA3520	107TA3510	107TA3499
16,75	107TA3643	107TA3575	107TA3520	107TA3510	107TA3499
18	107TA3644	107TA3576	107TA3520	107TA3510	107TA3499
19,05	107TA3645	107TA3577	107TA3521	107TA3511	107TA3500
20	107TA3646	107TA3578	107TA3521	107TA3511	107TA3500
21,25	107TA3647	107TA3579	107TA3521	107TA3511	107TA3500
22	107TA3648	107TA3580	107TA3521	107TA3511	107TA3500
25	107TA3649	107TA3581	107TA3521	107TA3511	107TA3500
25,4	107TA3650	107TA3582	107TA3521	107TA3511	107TA3500
26,75	107TA3651	107TA3583	107TA3522	107TA3512	107TA3501
28	107TA3652	107TA3584	107TA3522	107TA3512	107TA3501
30	107TA3653	107TA3585	107TA3522	107TA3512	107TA3501
31,75	107TA3654	107TA3586	107TA3523	107TA3513	107TA3502
33,5	107TA3655	107TA3587	107TA3523	107TA3513	107TA3502
35	107TA3656	107TA3588	107TA3523	107TA3513	107TA3502
38	107TA3657	107TA3589	107TA3523	107TA3513	107TA3502
42	107TA3658	107TA3590	107TA3523	107TA3513	107TA3502

					
Dia tube (mm)	REF	REF	REF	REF	REF
6	123TA9508	123TA9518	107TA3514	123TA9528	123TA9529
6,35	123TA9509	123TA9519	107TA3514	123TA9528	123TA9529
7,93	123TA9510	123TA9520	107TA3514	123TA9528	123TA9529
8	123TA9511	123TA9521	107TA3514	123TA9528	123TA9529
9,52	123TA9512	123TA9522	107TA3514	123TA9528	123TA9529
10	123TA9513	123TA9523	107TA3514	123TA9528	123TA9529
12	123TA9514	123TA9524	107TA3514	123TA9528	123TA9529
12,7	123TA9515	123TA9525	107TA3514	123TA9528	123TA9529
13,25	123TA9516	123TA9526	107TA3514	123TA9528	123TA9529
14	123TA9517	123TA9527	107TA3514	123TA9528	123TA9529

					
Dia tube (mm)	REF	REF	REF	REF	REF
M6 x 30					
6	107TA3591	107TA3524	107TA3514	107TA3503	107TA3492
6,35	107TA3592	107TA3525	107TA3514	107TA3503	107TA3492
7,93	107TA3593	107TA3526	107TA3514	107TA3503	107TA3492
8	107TA3594	107TA3527	107TA3514	107TA3503	107TA3492
9,52	107TA3595	107TA3528	107TA3514	107TA3503	107TA3492
10	107TA3596	107TA3529	107TA3514	107TA3503	107TA3492
12	107TA3597	107TA3530	107TA3514	107TA3503	107TA3492
12,7	107TA3598	107TA3531	107TA3514	107TA3503	107TA3492
13,25	107TA3599	107TA3532	107TA3514	107TA3503	107TA3492
M6 x 35					
13,25	107TA3600	107TA3533	107TA3498	107TA3504	107TA3493
14	107TA3601	107TA3534	107TA3498	107TA3504	107TA3493
15	107TA3602	107TA3535	107TA3498	107TA3504	107TA3493
15,87	107TA3603	107TA3536	107TA3498	107TA3504	107TA3493
16	107TA3604	107TA3537	107TA3498	107TA3504	107TA3493
16,75	107TA3605	107TA3538	107TA3498	107TA3504	107TA3493
18	107TA3606	107TA3539	107TA3498	107TA3504	107TA3493
M6 x 40					
19,05	107TA3607	107TA3540	107TA3515	107TA3505	107TA3494
20	107TA3608	107TA3541	107TA3515	107TA3505	107TA3494
21,25	107TA3609	107TA3542	107TA3515	107TA3505	107TA3494
22	107TA3610	107TA3543	107TA3515	107TA3505	107TA3494
23	107TA3611	107TA3544	107TA3515	107TA3505	107TA3494
25	107TA3612	107TA3545	107TA3515	107TA3505	107TA3494
25,4	107TA3613	107TA3546	107TA3515	107TA3505	107TA3494
M6 x 50					
26,75	107TA3614	107TA3547	107TA3516	107TA3506	107TA3495
28	107TA3615	107TA3548	107TA3516	107TA3506	107TA3495
30	107TA3616	107TA3549	107TA3516	107TA3506	107TA3495
31,75	107TA3617	107TA3550	107TA3516	107TA3506	107TA3495
32	107TA3618	107TA3551	107TA3516	107TA3506	107TA3495
M6 x 60					
33,5	107TA3619	107TA3552	107TA3517	107TA3507	107TA3496
35	107TA3620	107TA3553	107TA3517	107TA3507	107TA3496
38	107TA3621	107TA3554	107TA3517	107TA3507	107TA3496
40	107TA3622	107TA3555	107TA3517	107TA3507	107TA3496
42	107TA3623	107TA3556	107TA3517	107TA3507	107TA3496
45	107TA3624	107TA3557	107TA3517	107TA3507	107TA3496
M6 x 70					
44,5	107TA3625	107TA3558	107TA3518	107TA3508	107TA3497
48,3	107TA3626	107TA3559	107TA3518	107TA3508	107TA3497
50	107TA3627	107TA3560	107TA3518	107TA3508	107TA3497
50,8	107TA3628	107TA3561	107TA3518	107TA3508	107TA3497

For all other pipe brackets, please contact us.

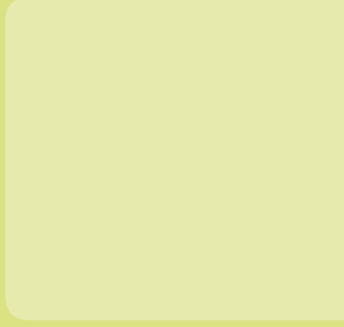

17

HYDRAULIC COUPLINGS



BC - BSP THREAD

Thread	Hose	REF
1/8 - 28	3/16	131TA5501
1/8 - 28	1/4	131TA5502
1/4 - 19	3/16	131TA5503
1/4 - 19	1/4	131TA5504
1/4 - 19	5/16	131TA5505
1/4 - 19	3/8	131TA5506
3/8 - 19	1/4	131TA5507
3/8 - 19	5/16	131TA5508
3/8 - 19	3/8	131TA5509
3/8 - 19	1/2	131TA5510
1/2 - 14	1/4	131TA5511
1/2 - 14	3/8	131TA5512
1/2 - 14	1/2	131TA5513
1/2 - 14	5/8	131TA5514
1/2 - 14	3/4	131TA5515
5/8 - 14	1/2	131TA5516
5/8 - 14	5/8	131TA5517
3/4 - 14	1/2	131TA5518
3/4 - 14	5/8	131TA5519
3/4 - 14	3/4	131TA5520
3/4 - 14	1	131TA5521
1 - 11	3/4	131TA5522
1 - 11	1	131TA5523
1 1/4 - 11	1 1/4	131TA5524
1 1/2 - 11	1 1/2	131TA5525
2 - 11	2	131TA5526



BJC - FEMALE CONE 60° - BSP THREAD

Thread	Hose	REF
1/4 - 19	1/4	131TA5527
3/8 - 19	3/8	131TA5528
1/2 - 14	1/2	131TA5529
3/4 - 14	3/4	131TA5530
1 - 11	1	131TA5531
1 1/4 - 11	1 1/4	131TA5532
1 1/2 - 11	1 1/2	131TA5533





BC45L - BSP THREAD

Thread	Hose	REF
1/8 - 28	3/16	131TA5534
1/8 - 28	1/4	131TA5535
1/4 - 19	1/4	131TA5536
3/8 - 19	1/4	131TA5537
3/8 - 19	5/16	131TA5538
3/8 - 19	3/8	131TA5539
3/8 - 19	1/2	131TA5540
1/2 - 14	3/8	131TA5541
1/2 - 14	1/2	131TA5542
5/8 - 14	1/2	131TA5543
5/8 - 14	5/8	131TA5544
3/4 - 14	5/8	131TA5545
3/4 - 14	3/4	131TA5546
1 - 11	3/4	131TA5547
1 - 11	1	131TA5548
1 1/4 - 11	1 1/4	131TA5549
1 1/2 - 11	1 1/2	131TA5550
2 - 11	2	131TA5551

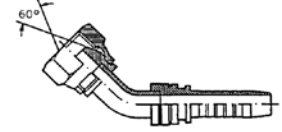

BC90K - BSP THREAD

Thread	Hose	REF
1/8 - 28	3/16	131TA5552
1/8 - 28	1/4	131TA5553
1/4 - 19	1/4	131TA5554
3/8 - 19	1/4	131TA5555
3/8 - 19	5/16	131TA5556
3/8 - 19	3/8	131TA5556
3/8 - 19	1/2	131TA5557
1/2 - 14	3/8	131TA5558
1/2 - 14	1/2	131TA5559
5/8 - 14	5/8	131TA5560
3/4 - 14	3/4	131TA5561
1 - 11	1	131TA5562
1 1/4 - 11	1 1/4	131TA5563

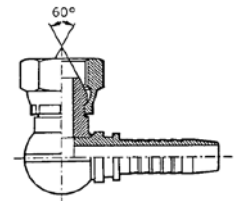



BC90L - BSP THREAD

Thread	Hose	REF
1/8 - 28	3/16	131TA5564
1/8 - 28	1/4	131TA5565
1/4 - 19	1/4	131TA5566
1/4 - 19	3/8	131TA5567
3/8 - 19	1/4	131TA5568
3/8 - 19	5/16	131TA5569
3/8 - 19	3/8	131TA5570
3/8 - 19	1/2	131TA5571
1/2 - 14	3/8	131TA5572
1/2 - 14	1/2	131TA5573
5/8 - 14	3/8	131TA5574
5/8 - 14	1/2	131TA5575
3/4 - 14	1/2	131TA5576
3/4 - 14	5/8	131TA5577
3/4 - 14	3/4	131TA5578
3/4 - 14	1	131TA5579
1 - 11	3/4	131TA5580
1 - 11	1	131TA5581
1 1/4 - 11	1 1/4	131TA5582



BB - BANJO - BSP THREAD

Banjo eye	Hose	REF
1/8	3/16	131TA5583
1/4	1/4	131TA5584
1/4	3/8	131TA5585
3/8	5/16	131TA5586
3/8	3/8	131TA5587
1/2	3/8	131TA5588
1/2	1/2	131TA5589
5/8	5/8	131TA5590
3/4	3/4	131TA5591
1	1	131TA5592
1 1/4	1 1/4	131TA5593

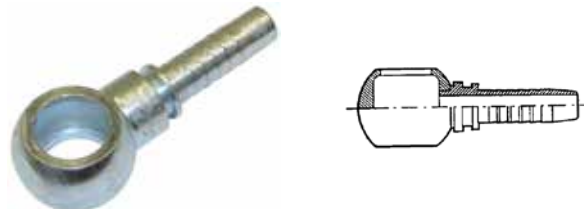



BD - BSP THREAD

Thread	Hose	REF
1/8 - 28	3/16	131TA5594
1/8 - 28	1/4	131TA5595
1/4 - 19	1/4	131TA5596
1/4 - 19	5/16	131TA5597
1/4 - 19	3/8	131TA5598
3/8 - 19	1/4	131TA5599
3/8 - 19	5/16	131TA5600
3/8 - 19	3/8	131TA5601
3/8 - 19	1/2	131TA5602
1/2 - 14	3/8	131TA5603
1/2 - 14	1/2	131TA5604
1/2 - 14	5/8	131TA5605
5/8 - 14	1/2	131TA5606
5/8 - 14	5/8	131TA5607
3/4 - 14	5/8	131TA5608
3/4 - 14	3/4	131TA5609
1 - 11	3/4	131TA5610
1 - 11	1	131TA5611
1 1/4 - 11	1 1/4	131TA5612
1 1/2 - 11	1 1/2	131TA5613
2 - 11	2	131TA5614

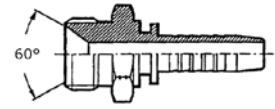

BDO - BSP THREAD + O-RING

Thread	Hose	REF
1/8 - 28	3/16	131TA5615
1/4 - 28	3/16	131TA5616

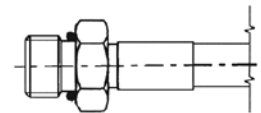



BDT - BSP CONICAL THREAD

Thread	Hose	REF
1/8 - 28	3/16	131TA5617
1/8 - 28	1/4	131TA5618
1/4 - 19	1/4	131TA5619
1/4 - 19	3/8	131TA5620
3/8 - 19	1/4	131TA5621
3/8 - 19	5/16	131TA5622
3/8 - 19	3/8	131TA5623
3/8 - 19	1/2	131TA5624
1/2 - 14	3/8	131TA5625
1/2 - 14	1/2	131TA5626
5/8 - 14	5/8	131TA5627
3/4 - 14	5/8	131TA5628
3/4 - 14	3/4	131TA5629
1 - 11	1	131TA5630
1 1/4 - 11	1 1/4	131TA5631
1 1/2 - 11	1 1/2	131TA5632
2 - 11	2	131TA5633



BF - FLAT SEAT - BSP THREAD

Thread	Hose	REF
1/8 - 28	1/4	131TA5634
1/4 - 19	1/4	131TA5635
1/4 - 19	3/8	131TA5636
3/8 - 19	1/4	131TA5637
3/8 - 19	5/16	131TA5638
3/8 - 19	3/8	131TA5639
1/2 - 14	5/16	131TA5640
1/2 - 14	3/8	131TA5641
1/2 - 14	1/2	131TA5642
5/8 - 14	1/2	131TA5643
5/8 - 14	5/8	131TA5644
3/4 - 14	1/2	131TA5645
3/4 - 14	5/8	131TA5646
3/4 - 14	3/4	131TA5647
1 - 11	3/4	131TA5648
1 - 11	1	131TA5649
1 1/4 - 11	1 1/2	131TA5650
1 1/2 - 11	1 1/2	131TA5651





BF90S - FLAT SEAT - BSP THREAD

Thread	Hose	REF
3/8 - 19	1/4	131TA5652
1/2 - 14	3/8	131TA5653
3/4 - 14	1/2	131TA5654
3/4 - 14	3/4	131TA5655

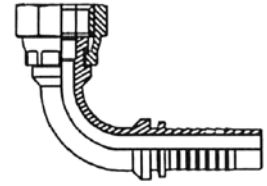

FE - FRENCH METRIC

Tube Ø (mm)	Thread	Hose	REF
13	M20 x 1,5	5/16	131TA5656
13	M20 x 1,5	3/8	131TA5657
17	M24 x 1,5	1/2	131TA5658
21	M30 x 1,5	5/8	131TA5659
21	M30 x 1,5	3/4	131TA5660
27	M36 x 1,5	3/4	131TA5661
30	M39 x 1,5	1	131TA5662
33	M45 x 1,5	1	131TA5663
42	M52 x 1,5	1 1/4	131TA5664



FF - FRENCH METRIC

Tube Ø (mm)	Thread	Hose	REF
13	M20 x 1,5	5/16	131TA5665
13	M20 x 1,5	3/8	131TA5666
17	M24 x 1,5	1/2	131TA5667
21	M30 x 1,5	5/8	131TA5668
21	M30 x 1,5	3/4	131TA5669
27	M36 x 1,5	3/4	131TA5670
28	M36 x 1,5	1	131TA5671
30	M39 x 1,5	1	131TA5672
33	M45 x 1,5	1	131TA5673
38	M48 x 1,5	1 1/4	131TA5674
42	M52 x 1,5	1 1/4	131TA5675



FF - 90S - FRENCH METRIC

Tube Ø (mm)	Thread	Hose	REF
17	M24 x 1,5	1/2	131TA5676
21	M30 x 1,5	5/8	131TA5677
27	M36 x 1,5	3/4	131TA5678

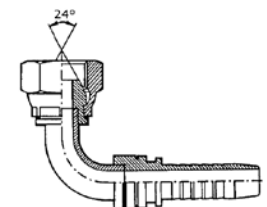



FSE - FRENCH STANDARD PIPE

Pipe Ø (mm)	Hose	REF
13	5/16	131TA5679
13	3/8	131TA5680
17	5/16	131TA5681
17	3/8	131TA5682
17	1/2	131TA5683
21	5/8	131TA5684
27	3/4	131TA5685
33	1	131TA5686

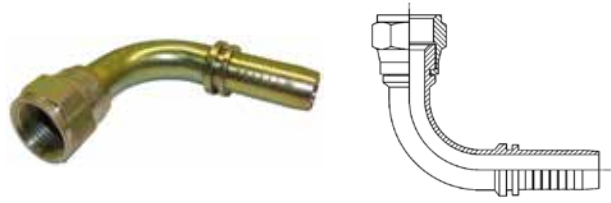

HDWN - HP CLEANER

A (mm)	Thread	Hose	REF
14	1/2 BSP	1/4	131TA5687
14	1/2 BSP	5/16	131TA5688
14	1/2 BSP	3/8	131TA5689
14	M21 x 1,5	1/4	131TA5690
14	M21 x 1,5	5/16	131TA5691
14	M21 x 1,5	3/8	131TA5692
14	M22 x 1,5	3/16	131TA5693
14	M22 x 1,5	1/4	131TA5694
15	M22 x 1,5	1/4	131TA5695
14	M22 x 1,5	5/16	131TA5696
15	M22 x 1,5	5/16	131TA5697
14	M22 x 1,5	3/8	131TA5698

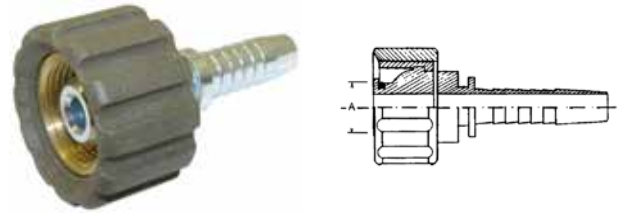

IF - INVERTED FLARE SAE THREAD 42° CONE

Thread	Hose	REF
7/16 - 24	1/4	131TA5699
1/2 - 20	3/8	131TA5700
5/8 - 18	3/8	131TA5701
3/4 - 18	1/2	131TA5702



IF45 - 42° CONE

Thread	Hose	REF
7/16 - 24	1/4	131TA5703
7/16 - 24	3/8	131TA5704
1/2 - 20	3/8	131TA5705
5/8 - 18	3/8	131TA5706





IF90 - 42° CONE

Thread	Hose	REF
7/16 - 24	1/4	131TA5707
1/2 - 20	5/16	131TA5708
1/2 - 20	3/8	131TA5709
5/8 - 18	3/8	131TA5710



JC - 37 JIC

Thread	Hose	REF
7/16 - 20	3/16	131TA5711
7/16 - 20	1/4	131TA5712
1/2 - 20	1/4	131TA5713
1/2 - 20	5/16	131TA5714
1/2 - 20	3/8	131TA5715
9/16 - 18	1/4	131TA5716
9/16 - 18	5/16	131TA5717
9/16 - 18	3/8	131TA5718
9/16 - 18	1/2	131TA5719
3/4 - 16	5/16	131TA5720
3/4 - 16	3/8	131TA5721
3/4 - 16	1/2	131TA5722
3/4 - 16	5/8	131TA5723
7/8 - 14	3/8	131TA5724
7/8 - 14	1/2	131TA5725
7/8 - 14	5/8	131TA5726
7/8 - 14	3/4	131TA5727
1 1/16 - 12	1/2	131TA5728
1 1/16 - 12	5/8	131TA5729
1 1/16 - 12	3/4	131TA5730
1 1/16 - 12	1	131TA5731
1 3/16 - 12	3/4	131TA5732
1 3/16 - 12	1	131TA5733
1 5/16 - 12	3/4	131TA5734
1 5/16 - 12	1	131TA5735
1 5/8 - 12	1	131TA5736
1 5/8 - 12	1 1/4	131TA5737
1 7/8 - 12	1 1/2	131TA5738
2 1/2 - 12	2	131TA5739

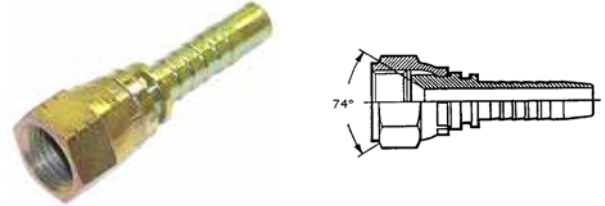



JC45S - 37 JIC

Thread	Hose	REF
7/16 - 2	1/4	131TA5740
1/2 - 20	1/4	131TA5741
1/2 - 20	5/16	131TA5742
1/2 - 20	3/8	131TA5743
9/16 - 18	1/4	131TA5744
9/16 - 18	5/16	131TA5745
9/16 - 18	3/8	131TA5746
3/4 - 16	3/8	131TA5747
3/4 - 16	1/2	131TA5748
7/8 - 14	3/8	131TA5749
7/8 - 14	1/2	131TA5750
7/8 - 14	5/8	131TA5751
1 1/16 - 12	1/2	131TA5752
1 1/16 - 12	5/8	131TA5753
1 1/16 - 12	3/4	131TA5754
1 3/16 - 12	5/8	131TA5755
1 3/16 - 12	3/4	131TA5756
1 3/16 - 12	1	131TA5757
1 5/16 - 12	3/4	131TA5758
1 5/16 - 12	1	131TA5759
1 5/8 - 12	1	131TA5760
1 5/8 - 12	1 1/4	131TA5761
1 7/8 - 12	1 1/2	131TA5762
2 1/2 - 12	2	131TA5763

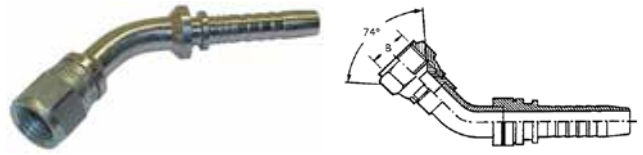

JC90K - 37 JIC

Thread	Hose	REF
7/16 - 20	1/4	131TA5764
1/2 - 20	1/4	131TA5765
9/16 - 18	1/4	131TA5766
9/16 - 18	3/8	131TA5767
3/4 - 16	3/8	131TA5768
3/4 - 16	1/2	131TA5769
7/8 - 14	1/2	131TA5770
7/8 - 14	5/8	131TA5771
1 1/16 - 12	5/8	131TA5772
1 1/16 - 12	3/4	131TA5773
1 3/16 - 12	3/4	131TA5774
1 5/16 - 12	1	131TA5775





JC90S - 37JIC

Thread	Hose	REF
7/16 - 20	1/4	131TA5776
1/2 - 20	1/4	131TA5777
1/2 - 20	5/16	131TA5778
1/2 - 20	3/8	131TA5779
9/16 - 18	1/4	131TA5780
9/16 - 18	5/16	131TA5781
9/16 - 18	3/8	131TA5782
3/4 - 16	3/8	131TA5783
3/4 - 16	1/2	131TA5784
7/8 - 14	5/8	131TA5787
7/8 - 14	3/8	131TA5785
7/8 - 14	1/2	131TA5786
1 1/16 - 12	1/2	131TA5788
1 1/16 - 12	5/8	131TA5789
1 1/16 - 12	3/4	131TA5790
1 3/16 - 12	5/8	131TA5791
1 3/16 - 12	3/4	131TA5792
1 3/16 - 12	1	131TA5793
1 5/16 - 12	3/4	131TA5794
1 5/16 - 12	1	131TA5795
1 5/8 - 12	1	131TA5796
1 5/8 - 12	1 1/4	131TA5797
1 7/8 - 12	1 1/2	131TA5798
2 1/2	2	131TA5799

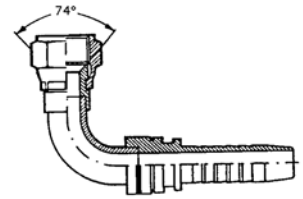



JCM - 37 JIC

Thread	Hose	REF
7/16 - 20	1/4	131TA5800
1/2 - 20	1/4	131TA5801
1/2 - 20	3/8	131TA5802
9/16 - 18	1/4	131TA5803
9/16 - 18	5/16	131TA5804
9/16 - 18	3/8	131TA5805
3/4 - 16	3/8	131TA5806
3/4 - 16	1/2	131TA5807
7/8 - 14	1/2	131TA5808
7/8 - 14	5/8	131TA5809
1 1/16 - 12	1/2	131TA5810
1 1/16 - 12	5/8	131TA5811
1 1/16 - 12	3/4	131TA5812
1 3/16 - 12	5/8	131TA5813
1 3/16 - 12	3/4	131TA5814
1 3/16 - 12	1	131TA5815
1 5/16 - 12	5/8	131TA5816
1 5/16 - 12	3/4	131TA5817
1 5/16 - 12	1	131TA5818
1 5/8 - 12	1 1/4	131TA5819
1 7/8 - 12	1 1/2	131TA5820
2 1/2 - 12	2	131TA5821



LIF - LINCOLN

Thread	Hose	REF
Unf 1/2 - 26	1/4	131TA5822



LIM - LINCOLN

Thread	Hose	REF
1/8 - 27	3/16	131TA5823

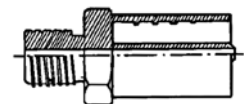



LRF - UNF FLAT SEAT

Thread	Hose	REF
9/16" x 18	1/4	131TA5824
11/16" x 16	1/4	131TA5825
11/16" x 16	5/16	131TA5826
11/16" x 16	3/8	131TA5827
13/16" x 16	3/8	131TA5828
13/16" x 16	1/2	131TA5829
1" x 14	5/8	131TA5830
1" 3/16" x 12	3/4	131TA5831
1 7/16" x 12	1	131TA5832
1 11/16" x 12	1 1/4	131TA5833
2" x 12	1 1/2	131TA5834

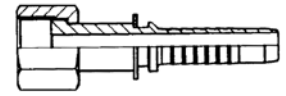

LRF45S - UNF FLAT SEAT

Thread	Hose	REF
9/16 - 18	1/4	131TA5835
11/16 - 16	3/8	131TA5836
13/16 - 16	1/2	131TA5837
1 - 14	5/8	131TA5838
1 3/16 - 12	3/4	131TA5839
1 7/16 - 12	1	131TA5840
1 11/16 - 12	1 1/4	131TA5841
2 - 12	1 1/2	131TA5842

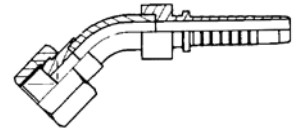

LRF90S - UNF FLAT SEAT

Thread	Hose	REF
9/16 - 18	1/4	131TA5843
11/16 - 16	5/16	131TA5844
11/16 - 16	3/8	131TA5845
13/16 - 16	1/2	131TA5846
1 - 14	5/8	131TA5847
1 3/16 - 12	3/4	131TA5848
1 7/16 - 12	1	131TA5849
1 11/16 - 12	1 1/4	131TA5850
2 - 12	1 1/2	131TA5851

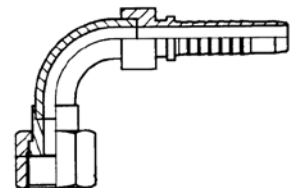



LRF90L - UNF FLAT SEAT

L (mm)	Thread	Hose	REF
57,9	9/16 - 18	1/4	131TA5852
69,1	11/16 - 16	3/8	131TA5853
82	13/16 - 16	1/2	131TA5854
94	1 - 14	5/8	131TA5855
96	1 3/16 - 12	3/4	131TA5856
106,8	1 7/16 - 12	1	131TA5857
129,3	1 11/16 - 12	1 1/4	131TA5858
146,1	2 - 12	1 1/2	131TA5859

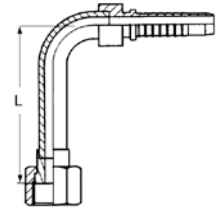



ME

Tube Ø (mm)	Thread	Hose	REF
6	M12 x 1,5	3/16	131TA5860
6	M12 x 1,5	1/4	131TA5861
6	M14 x 1,5	1/4	131TA5862
8	M14 x 1,5	1/4	131TA5863
8	M16 x 1,5	3/16	131TA5864
8	M16 x 1,5	1/4	131TA5865
8	M16 x 1,5	3/8	131TA5866
10	M16 x 1,5	1/4	131TA5867
10	M16 x 1,5	5/16	131TA5868
10	M16 x 1,5	3/8	131TA5869
10	M18 x 1,5	1/4	131TA5870
10	M18 x 1,5	3/8	131TA5871
12	M18 x 1,5	5/16	131TA5872
12	M18 x 1,5	3/8	131TA5873
12	M20 x 1,5	5/16	131TA5874
12	M20 x 1,5	3/8	131TA5875
14	M22 x 1,5	3/8	131TA5877
14	M22 x 1,5	1/2	131TA5878
15	M22 x 1,5	3/8	131TA5879
15	M22 x 1,5	1/2	131TA5880
16	M24 x 1,5	1/2	131TA5881
18	M26 x 1,5	1/2	131TA5882
18	M26 x 1,5	5/8	131TA5883
20	M30 x 2	1/2	131TA5884
20	M30 x 2	5/8	131TA5885
20	M30 x 2	3/4	131TA5886
22	M30 x 2	5/8	131TA5887
22	M30 x 2	3/4	131TA5888
22	M36 x 2	3/4	131TA5889
25	M36 x 2	3/4	131TA5890
25	M36 x 2	1	131TA5891
28	M36 x 2	1	131TA5892
30	M42 x 2	1	131TA5893
35	M45 x 2	1 1/4	131TA5894
38	M52 x 2	1 1/4	131TA5895
42	M52 x 2	1 1/2	131TA5896





MF - FRENCH METRIC

Thread	Hose	REF
M14 x 1,5	1/4	131TA5897
M16 x 1,5	5/16	131TA5898
M30 x 1,5	5/8	131TA5899
M30 x 1,5	3/4	131TA5900
M38 x 1,5	1	131TA5901
M45 x 1,5	1 1/4	131TA5902
M52 x 1,5	1 1/2	131TA5903
M65 x 2,0	2	131TA5904



MF90S - FRENCH METRIC

Thread	Hose	REF
M30 x 1,5	3/4	131TA5905

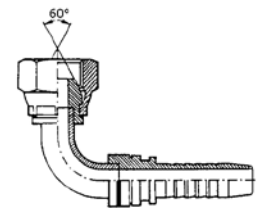

MFJ - METRIC THREAD 60° CONE

Thread	Hose	REF
M14 x 1,5	1/4	131TA5906
M16 x 1,5	1/4	131TA5907
M16 x 1,5	3/8	131TA5908
M18 x 1,5	3/8	131TA5909
M22 x 1,5	1/2	131TA5910
M24 x 1,5	1/2	131TA5911
M24 x 1,5	5/8	131TA5912
M28 x 1,5	5/8	131TA5913
M30 x 1,5	3/4	131TA5914
M33 x 1,5	1	131TA5915
M36 x 2,0	1 1/4	131TA5916
M42 x 2,0	1 1/2	131TA5917



MM - FRENCH METRIC 60°

Thread	Hose	REF
M30 x 1,5	5/8	131TA5918
M30 x 1,5	3/4	131TA5919
M38 x 1,5	1	131TA5920
M45 x 1,5	1 1/4	131TA5921
M52 x 1,5	1 1/2	131TA5922
M65 x 2,0	2	131TA5923

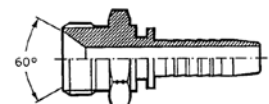



MSE

Tube Ø (mm)	Hose	REF
6	3/16	131TA5924
6	1/4	131TA5925
8	3/16	131TA5926
8	1/4	131TA5927
10	1/4	131TA5928
10	5/16	131TA5929
10	3/8	131TA5930
12	1/4	131TA5931
12	5/16	131TA5932
12	3/8	131TA5933
12	1/2	131TA5934
14	3/8	131TA5935
14	1/2	131TA5936
15	3/8	131TA5937
15	1/2	131TA5938
16	3/8	131TA5939
16	1/2	131TA5940
16	5/8	131TA5941
18	1/2	131TA5942
18	5/8	131TA5943
18	3/4	131TA5944
20	1/2	131TA5945
20	5/8	131TA5946
20	3/4	131TA5947
22	3/4	131TA5948
25	5/8	131TA5949
25	3/4	131TA5950
25	1	131TA5951
28	3/4	131TA5952
28	1	131TA5953
30	1	131TA5954
35	1 1/4	131TA5955
38	1 1/4	131TA5956
42	1 1/4	131TA5957
42	1 1/2	131TA5958





MSE45S

Tube Ø (mm)	Hose	REF
4	1/4	131TA5959
6	3/16	131TA5960
6	1/4	131TA5961
8	3/16	131TA5962
8	1/4	131TA5963
10	1/4	131TA5964
10	5/16	131TA5965
10	3/8	131TA5966
12	5/16	131TA5967
12	3/8	131TA5968
12	1/2	131TA5969
14	3/8	131TA5970
15	1/2	131TA5522
16	1/2	131TA5971
18	1/2	131TA5972
18	5/8	131TA5973
20	5/8	131TA5974
22	3/4	131TA5975
25	3/4	131TA5976
28	1	131TA5977
30	1	131TA5978
35	1 1/4	131TA5979
38	1 1/4	131TA5980
42	1 1/2	131TA5981

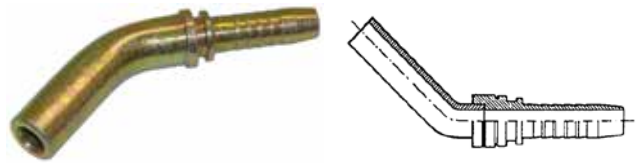



MSE90S

Tube Ø (mm)	Hose	REF
6	3/16	131TA5982
6	1/4	131TA5983
8	3/16	131TA5984
8	1/4	131TA5985
10	1/4	131TA5986
10	5/16	131TA5987
10	3/8	131TA5988
12	1/4	131TA5989
12	5/16	131TA5990
12	3/8	131TA5991
12	1/2	131TA5992
14	3/8	131TA5993
15	1/2	131TA5994
16	3/8	131TA5995
16	1/2	131TA5996
18	1/2	131TA5997
18	5/8	131TA5998
18	3/4	131TA5999
20	5/8	131TA6000
20	3/4	131TA6001
22	3/4	131TA6002
25	3/4	131TA6003
25	1	131TA6004
28	1	131TA6005
30	1	131TA6006
35	1 1/4	131TA6007
38	1 1/4	131TA6008
42	1 1/2	131TA6009

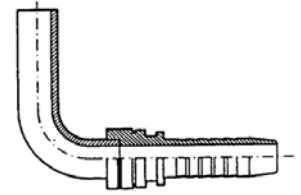

MBN - METRIC BANJO

Eye Ø (mm)	Hose	REF
10	3/16	131TA6010
10	1/4	131TA6011
12	1/4	131TA6012
14	1/4	131TA6013
14	5/16	131TA6014
16	5/16	131TA6015
16	3/8	131TA6016
18	3/8	131TA6017
18	1/2	131TA6018
22	1/2	131TA6019
22	5/8	131TA6020
26	3/4	131TA6021
30	1	131TA6022

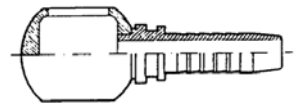



MBG - BSP BANJOBOLT

Thread	REF
1/8 - 28	131TA6023
1/4 - 19	131TA6024
3/8 - 19	131TA6025
1/2 - 14	131TA6026
5/8 - 14	131TA6027
3/4 - 14	131TA6028
1 - 11	131TA6029
1 1/4 - 11	131TA6030

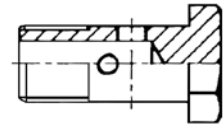

MBMG - METRIC BANJOBOLT

Thread	REF
M10 x 1,5	131TA6031
M12 x 1,5	131TA6032
M14 x 1,5	131TA6033
M16 x 1,5	131TA6034
M18 x 1,5	131TA6035
M22 x 1,5	131TA6036
M26 x 1,5	131TA6037
M30 x 2	131TA6038

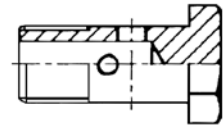



MSF - METRIC

Tube Ø (mm)	Thread	Hose	REF
6	M12 x 1	3/16	131TA6039
6	M12 x 1,5	3/16	131TA6040
6	M12 x 1,5	1/4	131TA6041
6	M14 x 1,5	1/4	131TA6042
8	M14 x 1,5	1/4	131TA6043
8	M16 x 1,5	3/16	131TA6044
8	M16 x 1,5	1/4	131TA6045
8	M16 x 1,5	3/8	131TA6046
10	M16 x 1,5	1/4	131TA6047
10	M16 x 1,5	5/16	131TA6048
10	M16 x 1,5	3/8	131TA6049
10	M18 x 1,5	1/7	131TA6050
10	M18 x 1,5	5/16	131TA6051
10	M18 x 1,5	3/8	131TA6052
12	M18 x 1,5	5/16	131TA6053
12	M18 x 1,5	3/8	131TA6054
12	M20 x 1,5	5/16	131TA6055
12	M20 x 1,5	3/8	131TA6056
12	M20 x 1,5	1/2	131TA6057
14	M20 x 1,5	3/8	131TA6058
14	M22 x 1,5	3/8	131TA6059
15	M22 x 1,5	1/2	131TA6060
16	M24 x 1,5	1/2	131TA6061
18	M26 x 1,5	1/2	131TA6062
18	M26 x 1,5	5/8	131TA6063
20	M27 x 1,5	5/8	131TA6064
20	M30 x 2	5/8	131TA6065
22	M30 x 2	5/8	131TA6066
22	M30 x 2	3/4	131TA6067
25	M36 x 2	3/4	131TA6068
28	M36 x 2	1	131TA6069
30	M42 x 2	1	131TA6070
35	M45 x 2	1 1/4	131TA6071
38	M48 x 2	1 1/4	131TA6072
38	M52 x 2	1 1/4	131TA6073
42	M52 x 2	1 1/2	131TA6074





MSF - 45S METRIC

Tube Ø (mm)	Thread	Hose	REF
6	M12 x 1,5	3/16	131TA6075
8	M14 x 1,5	1/4	131TA6076
8	M16 x 1,5	3/16	131TA6077
8	M16 x 1,5	1/4	131TA6078
10	M16 x 1,5	5/16	131TA6079
10	M18 x 1,5	3/8	131TA6080
10	M18 x 1,5	1/4	131TA6081
10	M18 x 1,5	3/8	131TA6082
12	M20 x 1,5	3/8	131TA6083
12	M20 x 1,5	5/16	131TA6084
12	M22 x 1,5	3/8	131TA6085
14	M22 x 1,5	3/8	131TA6086
15	M24 x 1,5	1/2	131TA6087
16	M26 x 1,5	1/2	131TA6088
18	M30 x 2	5/8	131TA6089
20	M30 x 2	5/8	131TA6090
22	M36 x 2	3/4	131TA6091
25	M36 x 2	3/4	131TA6092
28	M42 x 2	1	131TA6093
30	M45 x 2	1	131TA6094
35	M52 x 2	1 1/4	131TA6095
38	M52 x 2	1 1/4	131TA6096
42	M52 x 2	1 1/2	131TA6097

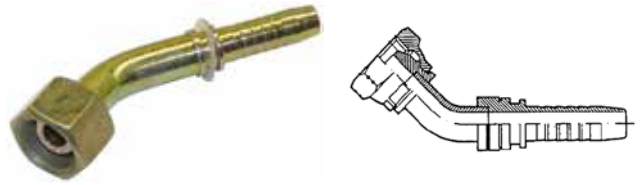



MSF - 90S METRIC

Tube Ø (mm)	Thread	Hose	REF
6	M12 x 1,5	3/16	131TA6098
6	M12 x 1,5	1/4	131TA6099
8	M14 x 1,5	1/4	131TA6100
8	M16 x 1,5	3/16	131TA6101
8	M16 x 1,5	1/4	131TA6102
10	M16 x 1,5	1/4	131TA6103
10	M16 x 1,5	5/16	131TA6104
10	M16 x 1,5	3/8	131TA6105
10	M18 x 1,5	1/4	131TA6106
12	M18 x 1,5	3/8	131TA6107
12	M20 x 1,5	5/16	131TA6108
12	M20 x 1,5	3/8	131TA6109
14	M22 x 1,5	3/8	131TA6110
15	M22 x 1,5	1/2	131TA6111
16	M24 x 1,5	1/2	131TA6112
18	M26 x 1,5	1/2	131TA6113
18	M26 x 1,5	5/8	131TA6114
20	M30 x 2	5/8	131TA6115
22	M30 x 2	3/4	131TA6116
25	M36 x 2	3/4	131TA6117
28	M36 x 2	1	131TA6118
30	M42 x 2	1	131TA6119
35	M45 x 2	1 1/4	131TA6120
38	M52 x 2	1 1/4	131TA6121

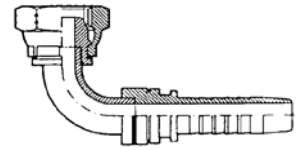



MSFO - METRIC O-RING

Tube Ø (mm)	Thread	Hose	REF
6	M12 x 1,5	3/16	131TA6122
6	M12 x 1,5	1/4	131TA6123
6	M14 x 1,5	1/4	131TA6124
8	M14 x 1,5	1/4	131TA6125
8	M16 x 1,5	3/16	131TA6126
8	M16 x 1,5	1/4	131TA6127
10	M16 x 1,5	1/4	131TA6128
10	M16 x 1,5	5/16	131TA6129
10	M16 x 1,5	3/8	131TA6130
10	M18 x 1,5	1/4	131TA6131
10	M18 x 1,5	3/8	131TA6132
12	M18 x 1,5	5/16	131TA6133
12	M18 x 1,5	3/8	131TA6134
12	M20 x 1,5	5/16	131TA6135
12	M20 x 1,5	3/8	131TA6136
14	M22 x 1,5	3/8	131TA6137
14	M22 x 1,5	1/2	131TA6138
15	M22 x 1,5	1/2	131TA6139
16	M24 x 1,5	1/2	131TA6140
18	M26 x 1,5	1/2	131TA6141
18	M26 x 1,5	5/8	131TA6142
20	M30 x 2	5/8	131TA6143
22	M30 x 2	3/4	131TA6144
25	M36 x 2	3/4	131TA6145
25	M36 x 2	1	131TA6146
28	M36 x 2	1	131TA6147
30	M42 x 2	1	131TA6148
35	M45 x 2	1 1/4	131TA6149
38	M52 x 2	1 1/4	131TA6150
42	M52 x 2	1 1/2	131TA6151





MSFO - 45S - METRIC O-RING

Tube Ø (mm)	Thread	Hose	REF
6	M12 x 1,5	3/16	131TA6152
8	M14 x 1,5	1/4	131TA6153
8	M16 x 1,5	3/16	131TA6154
10	M16 x 1,5	1/4	131TA6155
10	M16 x 1,5	5/16	131TA6156
10	M18 x 1,5	1/4	131TA6157
12	M18 x 1,5	3/8	131TA6158
12	M20 x 1,5	5/16	131TA6159
12	M20 x 1,5	3/8	131TA6160
14	M22 x 1,5	3/8	131TA6161
15	M22 x 1,5	1/2	131TA6162
16	M24 x 1,5	1/2	131TA6163
18	M26 x 1,5	5/8	131TA6164
20	M30 x 2	5/8	131TA6165
22	M30 x 1,5	3/4	131TA6166
25	M36 x 2	3/4	131TA6167
28	M36 x 2	1	131TA6168
30	M42 x 2	1	131TA6169
35	M45 x 2	1 1/4	131TA6170
38	M52 x 2	1 1/4	131TA6171
42	M52 x 2	1 1/2	131TA6172

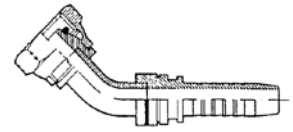



MSFO - 90S - METRIC O-RING

Tube Ø (mm)	Thread	Hose	REF
6	M12 x 1,5	3/16	131TA6173
6	M12 x 1,5	1/4	131TA6174
8	M14 x 1,5	1/4	131TA6175
8	M16 x 1,5	3/16	131TA6176
8	M16 x 1,5	1/4	131TA6177
10	M16 x 1,5	1/4	131TA6178
10	M16 x 1,5	5/16	131TA6179
10	M16 x 1,5	3/8	131TA6180
10	M18 x 1,5	1/4	131TA6181
12	M18 x 1,5	3/8	131TA6182
12	M20 x 1,5	5/16	131TA6183
12	M20 x 1,5	3/8	131TA6184
14	M22 x 1,5	3/8	131TA6185
15	M22 x 1,5	1/2	131TA6186
16	M24 x 1,5	1/2	131TA6187
18	M26 x 1,5	5/8	131TA6188
20	M30 x 2	5/8	131TA6189
22	M30 x 2	3/4	131TA6190
25	M36 x 2	3/4	131TA6191
28	M36 x 2	1	131TA6192
30	M42 x 2	1	131TA6193
35	M45 x 2	1 1/4	131TA6194
38	M52 x 2	1 1/4	131TA6195
42	M52 x 2	1 1/2	131TA6196

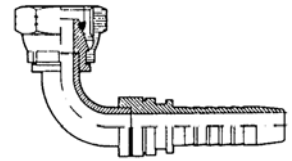

NF - NPT

Thread	Hose	REF
1/8 - 27	1/4	131TA6197
1/4 - 18	3/16	131TA6198
1/4 - 18	1/4	131TA6199
3/8 - 18	3/8	131TA6200
1/2 - 14	1/2	131TA6201

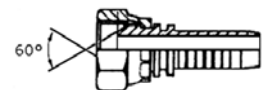



NM - NPT

Thread	Hose	REF
1/8 - 27	3/16	131TA6202
1/8 - 27	1/4	131TA6203
1/4 - 18	1/4	131TA6204
1/4 - 18	5/16	131TA6205
1/4 - 18	3/8	131TA6206
3/8 - 18	1/4	131TA6207
3/8 - 18	5/16	131TA6208
3/8 - 18	3/8	131TA6209
3/8 - 18	1/2	131TA6210
1/2 - 14	3/8	131TA6211
1/2 - 14	1/2	131TA6212
1/2 - 14	5/8	131TA6213
1/2 - 14	3/4	131TA6214
5/8 - 14	5/8	131TA6215
3/4 - 14	1/2	131TA6216
3/4 - 14	5/8	131TA6217
3/4 - 14	3/4	131TA6218
3/4 - 14	1	131TA6219
1 - 11,5	3/4	131TA6220
1 - 11,5	1	131TA6221
1 1/4 - 11,5	1	131TA6222
1 1/4 - 11,5	1 1/4	131TA6223
1 1/2 - 11,5	1 1/2	131TA6224
2 - 11,5	2	131TA6225

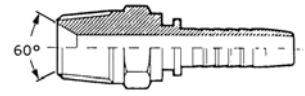

NMS - NPT SCREWTYPE

Thread	Hose	REF
1/4 - 18	1/4	131TA6226
3/8 - 18	3/8	131TA6227
3/8 - 18	1/2	131TA6228
1/2 - 14	3/8	131TA6229
1/2 - 14	1/2	131TA6230
3/4 - 14	3/4	131TA6231
1 - 11,5	1	131TA6232



ORM - UNF FLAT SEAT WITH O-RING

Thread	Hose	REF
9/16 x 18	1/4	131TA6233
11/16 x 16	3/8	131TA6234
13/16 x 16	1/2	131TA6235
1 3/16 x 12	3/4	131TA6236
1 7/16 x 12	1	131TA6237

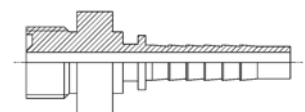



RS - STECK - O

Hose	REF
1/4	131TA6238
1/4	131TA6239
3/8	131TA6240
1/2	131TA6241
5/8	131TA6242
3/4	131TA6243
1	131TA6244
1 1/4	131TA6245

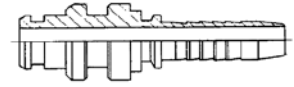

SSF - SAE

Thread	Hose	REF
5/8 - 18	5/16	131TA6246
5/8 - 18	3/8	131TA6247
7/8 - 14	1/2	131TA6248
1 1/16 - 14	3/4	131TA6249



SSM - SAE

Thread	Hose	REF
1/2 - 18	1/4	131TA6250
5/8 - 18	3/8	131TA6251
1 1/16 - 14	3/4	131TA6252

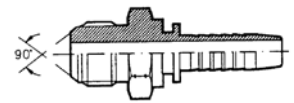

SSF45S - SAE

Thread	Hose	REF
5/8 - 18	3/8	131TA6253

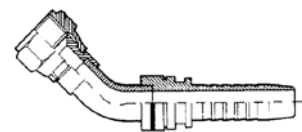

SSF90S - SAE

Thread	Hose	REF
5/8 - 18	3/8	131TA6254

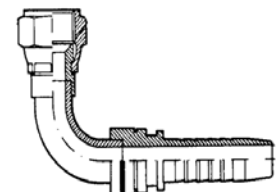



SSFH3 - SAE 3000PSI

A (mm)	Hose	REF
30,1	1/2	131TA6255
38,1	1/2	131TA6256
38,1	5/8	131TA6257
38,1	3/4	131TA6258
38,1	1	131TA6259
44,5	1/2	131TA6260
44,5	3/4	131TA6261
44,5	1	131TA6262
44,5	1 1/4	131TA6263
50,8	1	131TA6264
50,8	1 1/4	131TA6265
60,3	1	131TA6266
60,3	1 1/4	131TA6267
60,3	1 1/2	131TA6268
71,4	1 1/2	131TA6269
71,4	2	131TA6270

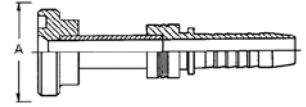

SSFH30S - 3 - SAE 3000PSI

A (mm)	Hose	REF
38,1	3/4	131TA6271
44,5	3/4	131TA6272
44,5	1	131TA6273
50,8	1	131TA6274
50,8	1 1/4	131TA6275
60,3	1 1/4	131TA6276
60,3	1 1/2	131TA6277

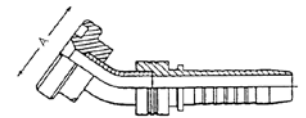

SSFH45S - 3 - SAE 3000PSI

A (mm)	Hose	REF
30,1	1/2	131TA6278
38,1	1/2	131TA6279
38,1	3/4	131TA6280
44,5	1/2	131TA6281
44,5	3/4	131TA6282
44,5	1	131TA6283
50,8	1	131TA6284
50,8	1 1/4	131TA6285
60,3	1	131TA6286
60,3	1 1/4	131TA6287
60,3	1 1/2	131TA6288
71,4	2	131TA6289

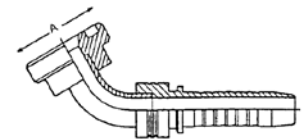



SSFH60S - 3 - SAE 3000PSI

A (mm)	Hose	REF
38,1	3/4	131TA6290
44,5	3/4	131TA6291
44,5	1	131TA6292
50,8	1	131TA6293
50,8	1 1/4	131TA6294
60,3	1 1/4	131TA6295
60,3	1 1/2	131TA6296

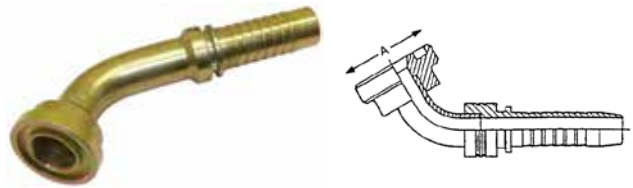

SSFH90S - 3 - SAE 3000PSI

A (mm)	Hose	REF
30,1	1/2	131TA6297
38,1	1/2	131TA6298
38,1	5/8	131TA6299
38,1	3/4	131TA6300
44,5	1/2	131TA6301
44,5	3/4	131TA6302
44,5	1	131TA6303
44,5	1 1/4	131TA6304
50,8	1	131TA6305
50,8	1 1/4	131TA6306
60,3	1	131TA6307
60,3	1 1/4	131TA6308
60,3	1 1/2	131TA6309
71,4	1 1/2	131TA6310
71,4	2	131TA6311

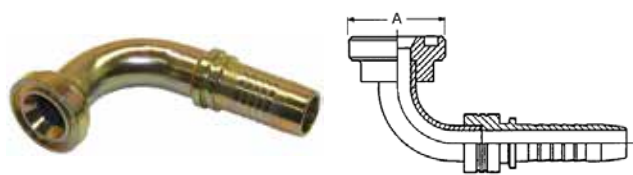

SSMR - SAE THREAD O-RING

Thread	Hose	REF
7/16 - 20	1/4	131TA6312
9/16 - 18	3/8	131TA6313
3/4 - 16	3/8	131TA6314
3/4 - 16	1/2	131TA6315
7/8 - 14	1/2	131TA6316
7/8 - 14	5/8	131TA6317
1 1/16 - 12	5/8	131TA6318
1 1/16 - 12	3/4	131TA6319
1 3/16 - 12	3/4	131TA6320
1 5/16 - 12	3/4	131TA6321
1 5/16 - 12	1	131TA6322

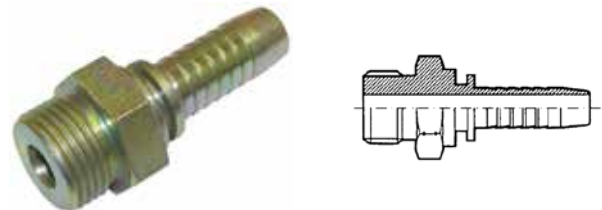



SSMRS - SAE THREAD SCREWTYPE

Thread	Hose	REF
3/4 - 16	3/8	131TA6323
3/4 - 16	1/2	131TA6324
7/8 - 14	1/2	131TA6325
7/8 - 14	5/8	131TA6326

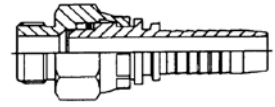

SSMRS - 1 - 90K SAE THREAD SCREWTYPE

Thread	Hose	REF
9/16 - 18	3/8	131TA6327
3/4 - 16	3/8	131TA6328
3/4 - 14	1/2	131TA6329
7/8 - 14	1/2	131TA6330
1 1/16 - 12	3/4	131TA6331

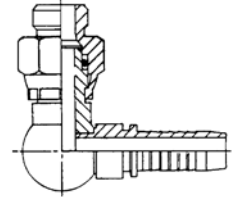

SSV

Hose	REF
1/4	131TA6332
5/16	131TA6333
3/8	131TA6334
1/2	131TA6335
5/8	131TA6336
3/4	131TA6337
1	131TA6338



R1/2 AT - 1SN/2SN - COMPACT 1SC/2SC - COVER NON - SKIVED

Inch	A (mm)	B (mm)	REF
3/16	20.0	21.0	131TA6339
1/4	23.0	29.6	131TA6340
5/16	24.0	30.5	131TA6341
3/8	26.0	31.2	131TA6342
1/2	29.7	33.5	131TA6343
5/8	33.0	36.0	131TA6344
3/4	37.0	40.0	131TA6345
1	47.0	50.0	131TA6345
1 1/4	59.0	57.0	131TA6346
1 1/2			131TA6347
2			131TA6348

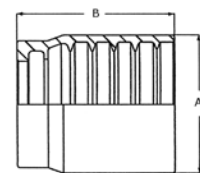



SAE100R7 - COVER THERMOPLASTIC

Inch	A (mm)	B (mm)	REF
3/16	14.5	25.5	131TA6349
1/4	16.6	32.5	131TA6350
5/16			131TA6351
3/8	21.0	32.0	131TA6352
1/2	24.6	36.5	131TA6353
3/4	30.1	44.5	131TA6354
1			131TA6355

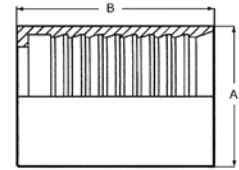

SAE100R8 - COVER THERMOPLASTIC

Inch	A (mm)	B (mm)	REF
3/16	14.2	27.5	131TA6356
1/4	20.6	30.2	131TA6357
5/16			131TA6358
3/8	23.0	33.3	131TA6359
1/2	26.2	36.5	131TA6360
5/8			131TA6361
3/4	33.33	44.5	131TA6362
1			131TA6363

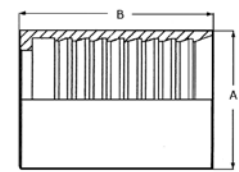







18

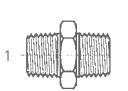
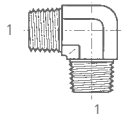
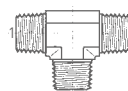
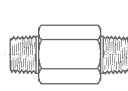

TUBE FITTINGS

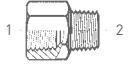
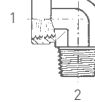
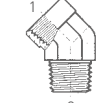
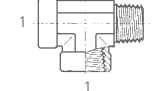
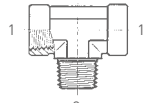

TUBE FITTINGS						
NPTF adaptors male/male						
Pipe thread male (1)	Pipe thread male (2)				Pipe thread male	
1/8	1/8	REF 124TA4169	REF 124TA4180	REF 125TA4605	1/8	REF 125TA4607
1/4	1/8	REF 124TA4170			1/8	REF 125TA4608
1/4	1/4	REF 111TA6218	REF 124TA4181		1/8	REF 125TA4609
3/8	1/8	REF 124TA4171		REF 124TA4186	1/8	REF 125TA4610
3/8	1/4	REF 124TA4172				
3/8	3/8	REF 124TA4173	REF 124TA4182	REF 125TA4606	1/4	REF 125TA4611
1/2	1/4	REF 124TA4174			1/4	REF 125TA4612
1/2	3/8	REF 125TA4602			1/4	REF 125TA4613
1/2	1/2	REF 124TA4175	REF 124TA4183		1/4	REF 125TA4614
3/4	1/2	REF 124TA4176		REF 124TA4187	1/4	REF 125TA4615
3/4	3/4	REF 124TA4177	REF 124TA4184			
1	1	REF 124TA4178	REF 124TA4185		1/2	REF 125TA4616
1.1/4	1	REF 124TA4179			1/2	REF 125TA4617
1.1/4	1.1/4	REF 125TA4603				
1.1/2	1.1/2	REF 125TA4604				

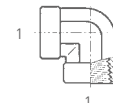
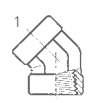
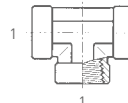
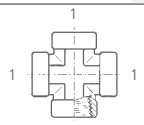



NPTF adaptors male/female							
Pipe thread female (1)	Pipe thread female (2)	Pipe thread reducer	Reducing connector	Street elbow	Street elbow 45°	Male run tee	Male branch tee
1/8	1/8			REF 124TA4211	REF 124TA4218	REF 124TA4224	REF 124TA4230
1/4	1/8	REF 124TA4188	REF 124TA4201				
1/4	1/4			REF 124TA4212	REF 124TA4219	REF 124TA4225	REF 124TA4231
3/8	1/8	REF 124TA4189					
3/8	1/4	REF 124TA4190	REF 124TA4202	REF 124TA4213			
3/8	3/8			REF 107TA7898	REF 124TA4220	REF 124TA4226	REF 124TA4232
1/2	1/8	REF 124TA4191	REF 124TA4203				
1/2	1/4	REF 124TA4192	REF 124TA4204				
1/2	3/8	REF 124TA4193	REF 124TA4205				
1/2	1/2			REF 124TA4214	REF 124TA4221	REF 124TA4227	REF 124TA4233
3/4	1/4	REF 124TA4194	REF 124TA4206				
3/4	3/8	REF 124TA4195					
3/4	1/2	REF 124TA4196	REF 124TA4207				
3/4	3/4			REF 124TA4215	REF 124TA4222	REF 124TA4228	REF 124TA4234
1	3/8	REF 124TA4197					
1	1/2	REF 124TA4198	REF 124TA4208				
1	3/4	REF 124TA4199	REF 124TA4209				
1	1			REF 124TA4216	REF 124TA4223	REF 124TA4229	
1.1/4	1/2	REF 125TA4618					
1.1/4	3/4	REF 125TA4619					
1.1/4	1	REF 124TA4200	REF 124TA4210				
1.1/4	1.1/4			REF 124TA4217			
1.1/2	3/4	REF 125TA4620					
1.1/2	1	REF 125TA4621					
1.1/2	1.1/4	REF 125TA4622					
2	1.1/4	REF 125TA4623					



NPTF adaptors female/female						
Pipe thread female (1)	Pipe thread female (2)					
1/8	1/8	REF 124TA4235	REF 124TA4246		REF 124TA4257	REF 124TA4264
1/4	1/8	REF 124TA4236				
1/4	1/4	REF 111TA6219	REF 124TA4247	REF 124TA4252	REF 124TA4258	REF 124TA4265
3/8	1/8	REF 124TA4237				
3/8	1/4	REF 124TA4238				
3/8	3/8	REF 124TA4239	REF 124TA4248	REF 124TA4253	REF 124TA4259	REF 124TA4266
1/2	1/4	REF 124TA4240				
1/2	3/8	REF 124TA4241				
1/2	1/2	REF 124TA4242	REF 124TA4249	REF 124TA4254	REF 124TA4260	REF 124TA4267
3/4	1/2	REF 124TA4243				
3/4	3/4	REF 124TA4244	REF 124TA4250	REF 124TA4255	REF 124TA4261	REF 124TA4268
1	1	REF 124TA4245	REF 124TA4251	REF 124TA4256	REF 124TA4262	REF 125TA4629
1.1/4	1.1/4	REF 125TA4624	REF 125TA4626		REF 124TA4263	
1.1/2	1.1/2	REF 125TA4625	REF 125TA4627		REF 125TA4628	

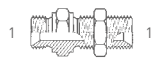

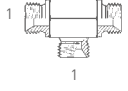
NPTF plug			
Pipe thread male			
1/16			REF 124TA4275
1/8		REF 124TA4269	REF 124TA4276
1/4		REF 124TA4270	REF 124TA4277
3/8		REF 124TA4271	REF 124TA4278
1/2		REF 124TA4272	REF 124TA4279
3/4		REF 124TA4273	REF 124TA4280
1		REF 124TA4274	



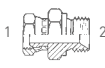

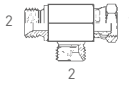
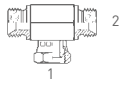
TUBE FITTINGS

Male/male adaptors BSPP 60° cone						
Thread (1)	Thread (2)	Male union	Bulkhead union	Union elbow	Union tee	Hex head plug
1/4	1/4	REF 125TA4630	REF 125TA4636	REF 124TA4285	REF 125TA4645	REF 125TA4650
3/8	1/4	REF 125TA4631				
3/8	3/8	REF 125TA4632	REF 125TA4637	REF 125TA4641	REF 125TA4646	REF 125TA4651
1/2	3/8	REF 125TA4633				
1/2	1/2	REF 124TA4281	REF 125TA4638	REF 125TA4642	REF 125TA4647	REF 124TA4286
5/8	5/8	REF 125TA4634				
3/4	1/2	REF 124TA4282				
3/4	3/4	REF 124TA4283	REF 125TA4639	REF 125TA4643	REF 125TA4648	REF 125TA4652
1	3/4	REF 124TA4284				
1	1	REF 125TA4635	REF 125TA4640	REF 125TA4644	REF 125TA4649	REF 125TA4653

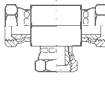
Male/female adaptors BSPP 60° cone					
Thread (1)	Thread (2)	Swivel nut male adaptor	Swivel nut elbow	Swivel nut run tee	Swivel nut branch tee
1/4	1/4	REF 124TA4287	REF 124TA4289	REF 124TA4293	REF 124TA4294
3/8	1/4	REF 125TA4654			
3/8	3/8	REF 125TA4655	REF 124TA4290	REF 125TA4662	REF 125TA4666
1/2	3/8	REF 125TA4656			
1/2	1/2	REF 125TA4657	REF 124TA4291	REF 125TA4663	REF 124TA4295
3/4	1/2	REF 125TA4658			
3/4	3/4	REF 124TA4288	REF 125TA4661	REF 125TA4664	REF 125TA4667
1	3/4	REF 125TA4659			
1	1	REF 125TA4660	REF 124TA4292	REF 125TA4665	REF 125TA4668

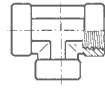
Female/female adaptors BSPP 60° cone				
Thread		Swivel union	Swivel elbow	Swivel tee
1/4		REF 125TA4669	REF 125TA4674	REF 125TA4678
3/8		REF 125TA4670	REF 125TA4675	REF 125TA4679
1/2		REF 125TA4671	REF 125TA4676	REF 125TA4680
3/4		REF 125TA4672	REF 124TA4296	REF 125TA4681
1		REF 125TA4673	REF 125TA4677	REF 125TA4682

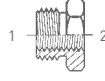
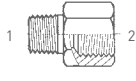

BSPP adaptors female/female			
Thread			
1/8		REF 124TA4297	
1/4		REF 124TA4298	REF 125TA4684
3/8		REF 124TA4299	REF 125TA4685
1/2		REF 124TA4300	REF 125TA4686
3/4		REF 124TA4301	REF 125TA4687
1		REF 125TA4683	REF 125TA4688

BSPT male plug		
Male thread		
1/8		REF 124TA4269
1/4		REF 125TA4689
3/8		REF 124TA4302
1/2		REF 124TA4303
3/4		REF 125TA4690
1		REF 125TA4691

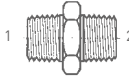

Reducing bushes BSPP/BSPT			
BSPP/BSPT male thread (1)	BSPP female thread (2)	Reducing bush BSPP/BSPP	Reducing bush BSPP/BSPT
1/4	1/8	REF 125TA4692	REF 124TA4308
3/8	1/4	REF 125TA4693	REF 124TA4309
1/2	1/4	REF 124TA4304	
1/2	3/8	REF 124TA4305	REF 124TA4310
3/4	3/8	REF 125TA4694	REF 125TA4698
3/4	1/2	REF 124TA4306	REF 125TA4699
1	1/4	REF 125TA4695	
1	3/8	REF 125TA4696	
1	1/2	REF 124TA4307	
1	3/4	REF 125TA4697	REF 125TA4700



Male union BSPT		
Thread (1)	Thread (2)	
1/8	1/8	REF 124TA4169
1/4	1/8	REF 124TA4311
1/4	1/4	REF 124TA4312
3/8	1/4	REF 124TA4172
3/8	3/8	REF 124TA4313
1/2	3/8	REF 125TA4701
1/2	1/2	REF 124TA4314
3/4	1/2	REF 125TA4702
3/4	3/4	REF 124TA4315
1	3/4	REF 125TA4703
1	1	REF 125TA4704

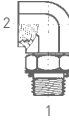
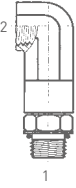

TUBE FITTINGS			
UNF plugs			
Thread			
5/16-24		REF 124TA4316	REF 124TA4328
3/8-24		REF 124TA4317	REF 124TA4329
7/16-20		REF 124TA4318	REF 124TA4330
1/2-20		REF 124TA4319	REF 124TA4331
9/16-18		REF 124TA4320	REF 124TA4332
3/4-16		REF 124TA4321	REF 124TA4333
7/8-14		REF 124TA4322	REF 124TA4334
1.1/16-12		REF 124TA4323	REF 124TA4335
1.5/16-12		REF 124TA4324	REF 124TA4336
1.5/8-12		REF 124TA4325	REF 124TA4337
1.7/8-12		REF 124TA4326	
2.1/2-12		REF 124TA4327	

UNF/NPTF adaptors				
UNF male thread (1)	UNF female thread (2)			
9/16-18	1/4	REF 125TA4705		
3/4-16	1/4	REF 125TA4706		
3/4-16	3/8	REF 125TA4707	REF 124TA4352	REF 124TA4356
3/4-16	1/2	REF 125TA4708		
7/8-14	1/4	REF 125TA4709		
7/8-14	3/8	REF 125TA4710		
7/8-14	1/2	REF 125TA4711	REF 124TA4353	REF 124TA4357
7/8-14	3/4	REF 125TA4712		
1.1/16-12	1/2	REF 125TA4713		
1.1/16-12	3/4	REF 125TA4714	REF 124TA4354	REF 124TA4358
1.5/16-12	1/2	REF 125TA4715		
1.5/16-12	3/4	REF 125TA4716		
1.5/16-12	1	REF 125TA4717	REF 124TA4355	REF 124TA4359
1.5/8-12	1	REF 125TA4718		
1.5/8-12	1.1/4	REF 125TA4719		
1.7/8-12	1	REF 125TA4720		
1.7/8-12	1.1/2	REF 125TA4721		

UNF/UNF adaptors			
Thread (1)	Thread (2)	Straight thread reducer	Straight thread union
7/16-20	7/16-20		REF 125TA4729
7/16-20	9/16-18	REF 125TA4722	REF 125TA4730
9/16-18	7/16-20	REF 124TA4360	
9/16-18	9/16-18		
9/16-18	3/4-16	REF 124TA4361	
3/4-16	9/16-18	REF 125TA4723	
3/4-16	3/4-16		REF 131TA9473
3/4-16	7/8-14	REF 125TA4724	
7/8-14	9/16-18	REF 125TA4725	
7/8-14	3/4-16	REF 124TA4362	
7/8-14	1.1/16-12	REF 124TA4363	
1.1/16-12	3/4-16	REF 124TA4364	
1.1/16-12	7/8-14	REF 124TA4365	
7/8-14	7/8-14		REF 125TA4732
1.5/16-12	3/4-16	REF 124TA4366	
1.1/16-12	1.1/16-12		REF 125TA4733
1.5/16-12	1.1/16-12	REF 124TA4367	
1.5/8-12	1.1/16-12	REF 124TA4368	
1.5/8-12	1.5/16-12	REF 125TA4726	
1.7/8-12	1.1/16-12	REF 125TA4727	
1.7/8-12	1.5/16-12	REF 125TA4728	
1.7/8-12	1.5/8-12	REF 124TA4369	

BSPT-BSPP-metric UNF Conversion adaptors						
UNF female thread	BSPT male thread	Male BSPT to female UNF thread	BSPP male thread	Male BSPP to female UNF thread	Metric male thread	Male metric to female UNF thread
7/16-20	1/8	REF 124TA4370	1/8	REF 125TA4740	M10x1	REF 125TA4747
9/16-18	1/8	REF 125TA4734	1/4	REF 131TA9474	M14x1,5	REF 125TA4748
9/16-18			3/8	REF 125TA4742		
3/4-16	1/4	REF 125TA4735			M16x1,5	REF 125TA4749
7/8-14	3/8	REF 125TA4736	1/2	REF 125TA4743	M22x1,5	REF 125TA4750
1.1/16-12	1/2	REF 125TA4737	3/4	REF 125TA4744	M27x2	REF 125TA4751
1.5/16-12	3/4	REF 125TA4738	1	REF 125TA4745	M33x2	REF 125TA4752
1.5/8-12					M42x2	REF 125TA4753
1.7/8-12	1	REF 125TA4739	1.1/4	REF 125TA4746	M50x2	REF 125TA4754



TUBE FITTINGS





JIS adaptors BSPP-BSPT							
BSPT thread (1)	BSPP thread (2)						
1/4	1/4	REF 125TA4755	REF 125TA4760	REF 125TA4764	REF 125TA4769	REF 125TA4774	REF 125TA4779
3/8	3/8	REF 125TA4756	REF 124TA4371	REF 125TA4765	REF 125TA4770	REF 125TA4775	REF 125TA4780
1/2	1/2	REF 125TA4757	REF 125TA4761	REF 125TA4766	REF 125TA4771	REF 125TA4776	REF 125TA4781
3/4	3/4	REF 125TA4758	REF 125TA4762	REF 125TA4767	REF 125TA4772	REF 125TA4777	REF 125TA4782
1	1	REF 125TA4759	REF 125TA4763	REF 125TA4768	REF 125TA4773	REF 125TA4778	REF 125TA4783

JIS unions			
BSPP thread (1)	BSPP thread (2)		
1/4	1/4	REF 125TA4784	REF 125TA4789
3/8	3/8	REF 125TA4785	REF 125TA4790
1/2	1/2	REF 125TA4786	REF 125TA4791
3/4	3/4	REF 125TA4787	REF 125TA4792
1	1	REF 125TA4788	REF 125TA4793

JIS adaptors - BSPT				
BSPT thread 30° male (1)	BSPT thread (2)			
1/4	1/4	REF 124TA4372	REF 124TA4380	REF 124TA4385
1/4	3/8	REF 124TA4373		
3/8	1/4	REF 124TA4374		
3/8	3/8	REF 124TA4375	REF 124TA4381	REF 124TA4386
1/2	3/8	REF 124TA4376		
1/2	1/2	REF 124TA4377	REF 124TA4382	REF 124TA4387
3/4	3/4	REF 124TA4378	REF 124TA4383	REF 124TA4388
1	1	REF 124TA4379	REF 124TA4384	REF 124TA4389

JIC 37° adaptors (Triple-Lok)										
SAE thread JIC 37°	NPTF thread	Male union NPTF	UNF thread	Male union UNF	BSPP thread	Male union BSPP	Metric thread ISO 6149	Male union ISO 6149	Metric thread DIN 3852	Male union DIN 3852
7/16-20	1/8	REF 124TA4390	7/16	REF 107TA3680	1/8	REF 125TA4798		REF 125TA4818	M10x1	REF 125TA4829
7/16-20	1/4	REF 124TA4391	1/2	REF 124TA3724	1/4	REF 124TA3653	M10x1			
7/16-20	3/8	REF 124TA4392	9/16	REF 124TA3725	3/8	REF 125TA4799				
7/16-20	1/2	REF 124TA4393	3/4	REF 124TA4400	1/2	REF 125TA4800				
1/2-20	1/8	REF 124TA3430	1/2	REF 124TA3727	1/4	REF 125TA4801	M12x1,5	REF 125TA4819	M12x1,5	REF 125TA4830
1/2-20	1/4	REF 124TA3431	9/16	REF 124TA4401	3/8	REF 125TA4802				
9/16-18	1/8	REF 124TA4393	7/16	REF 124TA3728	1/8	REF 124TA3654				
9/16-18	1/4	REF 124TA4394	1/2	REF 124TA4402	1/4	REF 125TA4803	M14x1,5	REF 125TA4820	M14x1,5	REF 125TA4831
9/16-18	3/8	REF 124TA4395	9/16	REF 107TA3668	3/8	REF 124TA3655				
9/16-18	1/2	REF 124TA3435	3/4	REF 124TA3729	1/2	REF 124TA3656	M16x1,5	REF 125TA4821	M16x1,5	REF 125TA4832
3/4-16	1/4	REF 124TA4396	9/16	REF 124TA3731	1/4	REF 125TA4804				
3/4-16	3/8	REF 124TA4397	3/4	REF 113TA1676	3/8	REF 124TA3657	M16x1,5	REF 125TA4822	M16x1,5	REF 125TA4833
3/4-16	1/2	REF 124TA4398	7/8	REF 125TA4794	1/2	REF 125TA4805				
3/4-16	3/4	REF 124TA3439	1.1/16	REF 124TA3733	3/4	REF 125TA4806				
7/8-14	3/8	REF 124TA3440	3/4	REF 124TA3735	3/8	REF 125TA4807	M18x1,5	REF 125TA4823	M18x1,5	REF 125TA4834
7/8-14	1/2	REF 124TA3441	7/8	REF 124TA3734	1/2	REF 124TA3658	M22x1,5	REF 125TA4824	M22x1,5	REF 125TA4835
7/8-14	3/4	REF 124TA3442	1.1/16	REF 124TA3736	3/4	REF 124TA3659				
1.1/16-12	1/2	REF 124TA3443	3/4	REF 124TA3738	1/2	REF 125TA4808	M22x1,5	REF 125TA4824	M22x1,5	REF 125TA4836
1.1/16-12	3/4	REF 124TA3444	7/8	REF 124TA3739	3/4	REF 124TA3661	M27x	REF 125TA4825	M27x	REF 125TA4837
1.1/16-12	1	REF 124TA3445	1.1/16	REF 124TA3737	1	REF 125TA4809				
1.1/16-12			1.3/16	REF 125TA4795						
1.1/16-12			1.5/16	REF 124TA3740						
1.3/16-12	3/4	REF 124TA3446	1.3/16	REF 124TA3741	3/4	REF 124TA3662				
1.3/16-12			1.5/16	REF 125TA4796						
1.5/16-12			7/8	REF 124TA3744						
1.5/16-12	3/4	REF 124TA3447	1.1/16	REF 124TA3745	3/4	REF 125TA4810				
1.5/16-12	1	REF 124TA3448	1.5/16	REF 124TA3743	1	REF 125TA4811	M33x	REF 125TA4826	M33x	REF 125TA4838
1.5/16-12			1.5/8	REF 124TA4403	1.1/4	REF 125TA4812				
1.5/8-12	1	REF 124TA3449	1.5/16	REF 124TA3749	1	REF 125TA4813				
1.5/8-12	1.1/4	REF 124TA4399	1.5/8	REF 124TA3748	1.1/4	REF 125TA4814	M42x2	REF 125TA4827	M42x2	REF 125TA4839
1.7/8-12	1.1/4	REF 124TA3451	1.5/8	REF 124TA4404	1.1/4	REF 125TA4815				
1.7/8-12	1.1/2	REF 124TA3452	1.7/8	REF 124TA3750	1.1/2	REF 125TA4816	M48x2	REF 125TA4828	M48x2	REF 125TA4840
2.1/4-12					1.1/2	REF 125TA4817				
2.1/2-12	2	REF 124TA3453	2.1/2	REF 125TA4797						



TUBE FITTINGS										
ORFS adaptors (O-Lok)										
UNF straight thread ORFS	NPTF thread	Male union NPTF	UNF thread	Male union UNF	BSP thread	Male union BSP	Metric thread ISO 6149	Male union ISO 6149	Metric thread DIN 3852	Male union DIN 3852
9/16-18	1/8	REF 124TA4405	7/16	REF 124TA4422	1/8	REF 124TA4436				
9/16-18	1/4	REF 124TA4406			1/4	REF 124TA4437	M12x1	REF 124TA4462	M12x1	REF 124TA4468
9/16-18	3/8	REF 124TA4407	9/16	REF 124TA4423	3/8	REF 124TA4438				
9/16-18			3/4	REF 125TA4843	1/2	REF 124TA4439				
11/16-16			7/16	REF 124TA4424	1/8	REF 124TA4440				
11/16-16	1/4	REF 124TA4408			1/4	REF 124TA4441	M16x1,5	REF 124TA4463	M16x1,5	REF 125TA4861
11/16-16	3/8	REF 124TA4409	9/16	REF 124TA4425	3/8	REF 124TA4442				
11/16-16	1/2	REF 124TA4410	3/4	REF 124TA4426	1/2	REF 124TA4443				
11/16-16			7/8	REF 125TA4844	3/4	REF 124TA4444				
13/16-16			9/16	REF 124TA4427	1/4	REF 124TA4445				
13/16-16	3/8	REF 124TA4411	3/4	REF 124TA4428	3/8	REF 124TA4446	M18x1,5	REF 124TA4464	M18x1,5	REF 124TA4469
13/16-16	1/2	REF 124TA4412	7/8	REF 124TA4429	1/2	REF 124TA4447				
13/16-16	3/4	REF 124TA4413	1.1/16	REF 125TA4845	3/4	REF 124TA4448				
13/16-16			1.5/16	REF 125TA4846						
1-14			3/4	REF 124TA4430	3/8	REF 124TA4449				
1-14	1/2	REF 124TA4414	7/8	REF 125TA4847	1/2	REF 124TA4450	M22x1,5	REF 124TA4465	M22x1,5	REF 124TA4470
1-14	3/4	REF 125TA4841	1.1/16	REF 124TA4431	3/4	REF 124TA4451				
1.3/16-12	1/2	REF 124TA4415	3/4	REF 125TA4848	1/2	REF 124TA4452				
1.3/16-12	3/4	REF 124TA4416	7/8	REF 125TA4849	3/4	REF 124TA4453	M27x2	REF 124TA4466	M27x1,5	REF 124TA4471
1.3/16-12	1	REF 124TA4417	1.1/16	REF 125TA4850	1	REF 124TA4454				
1.3/16-12			1.5/16	REF 124TA4433						
1.7/16-12	3/4	REF 124TA4418	1.1/16	REF 124TA4434	3/4	REF 124TA4455				
1.7/16-12	1	REF 124TA4419	1.5/16	REF 124TA4435	1	REF 124TA4456	M33x2	REF 124TA4467	M33x2	REF 124TA4472
1.7/16-12			1.5/8	REF 125TA4851	1.1/4	REF 124TA4457				
1.11/16-12	1	REF 125TA4842	1.5/16	REF 125TA4852	1	REF 124TA4458				
1.11/16-12	1.1/4	REF 124TA4420	1.5/8	REF 125TA4853	1.1/4	REF 124TA4459	M42x2	REF 125TA4859	M42x2	REF 124TA4473
1.11/16-12			1.7/8	REF 125TA4854	1.1/2	REF 125TA4857				
2-12			1.5/8	REF 125TA4855	1.1/4	REF 125TA4858	M48x2	REF 125TA4860	M48x2	REF 125TA4862
2-12	1.1/2	REF 124TA4421	1.7/8	REF 125TA4856	1.1/2	REF 124TA4461				



PLUG

Thread	REF
1/8" BSP	152TA2683
1/4" BSP	163TA8231
3/8" BSP	152TA2678
1/2" BSP	152TA2679
3/4" BSP	163TA8232
1" BSP	152TA2676

Thread	REF
3/8 UNF	124TA4329
7/16 UNF	152TA2687
1/2 UNF	163TA8233
9/16UNF	124TA4332
3/4 UNF	152TA2686
7/8 UNF	124TA4334
1" 1/16UNF	163TA8234

Thread	REF
M10 x 1	163TA8235
M12 x 1,5	163TA8236
M14 x 1,5	116TA5334
M16 x 1,5	163TA8237
M18 x 1,5	163TA8238
M20 x 1,5	163TA8239
M22 x 1,5	163TA8240



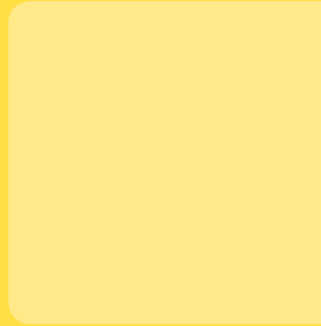









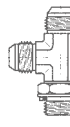

19

TRIPLE-LOK PLUS

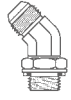
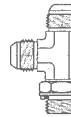

TRIPLE-LOK PLUS											
BSPB adapter male											
Tube outer Ø		JIC thread SAE	Thread BSPB								
mm	inch										
6	1/4	7/16-20	1/8	REF 125TA4798	REF 124TA3663	REF 124TA3683	REF 124TA3691	REF 124TA3698	REF 125TA4871	REF 124TA3706	
6	1/4	7/16-20	1/4	REF 124TA3653	REF 124TA3664	REF 125TA4866			REF 125TA4872	REF 124TA3707	
6	1/4	7/16-20	3/8	REF 125TA4799							
6	1/4	7/16-20	1/2	REF 125TA4800							
8	5/16	1/2-20	1/8	REF 125TA4863	REF 124TA3665	REF 124TA3684			REF 125TA4873	REF 124TA3708	
8	5/16	1/2-20	1/4	REF 125TA4801	REF 124TA3666	REF 125TA4867			REF 125TA4874	REF 124TA3709	
8	5/16	1/2-20	3/8	REF 125TA4802							
10	3/8	9/16-18	1/8	REF 125TA4864							
10	3/8	9/16-18	1/4	REF 124TA3654	REF 124TA3667	REF 124TA3685	REF 124TA3692	REF 124TA3699	REF 125TA4875	REF 124TA3710	
10	3/8	9/16-18	3/8	REF 125TA4865	REF 124TA3668				REF 125TA4876	REF 124TA3711	
10	3/8	9/16-18	1/2	REF 124TA3655	REF 124TA3669						
12	1/2	3/4-16	1/4	REF 124TA3656	REF 124TA3670				REF 125TA4877		
12	1/2	3/4-16	3/8	REF 125TA4804	REF 124TA3671	REF 124TA3686	REF 124TA3693	REF 124TA3700	REF 125TA4878	REF 124TA3712	
12	1/2	3/4-16	1/2	REF 124TA3657	REF 124TA3672	REF 125TA4868		REF 125TA4870		REF 124TA3713	
12	1/2	3/4-16	3/4	REF 125TA4805							
14, 15, 16	5/8	7/8-14	3/8	REF 125TA4806					REF 125TA4879		
14, 15, 16	5/8	7/8-14	1/2	REF 125TA4807	REF 124TA3673	REF 124TA3687	REF 124TA3694	REF 124TA3701	REF 125TA4880	REF 124TA3714	
14, 15, 16	5/8	7/8-14	3/4	REF 124TA3658	REF 124TA3674	REF 125TA4869					
18, 20	3/4	1.1/16-12	3/8	REF 124TA3659							
18, 20	3/4	1.1/16-12	1/2	REF 124TA3660	REF 124TA3675				REF 125TA4881		
18, 20	3/4	1.1/16-12	3/4	REF 125TA4808	REF 124TA3676	REF 124TA3688	REF 124TA3695	REF 124TA3702	REF 125TA4882	REF 124TA3715	
18, 20	3/4	1.1/16-12	1	REF 124TA3661	REF 125TA6248						
22	7/8	1.3/16-12	3/4	REF 125TA4809	REF 125TA6249						
25	1	1.5/16-12	3/4	REF 124TA3662	REF 124TA3677				REF 125TA4883		
25	1	1.5/16-12	1	REF 125TA4811	REF 124TA3678	REF 124TA3689	REF 124TA3696	REF 124TA3703	REF 124TA3705	REF 124TA3716	
25	1	1.5/16-12	1.1/4	REF 125TA4812							
28, 30, 32	1.1/4	1.5/8-12	1	REF 125TA4813	REF 124TA3679				REF 125TA4884		
28, 30, 32	1.1/4	1.5/8-12	1.1/4	REF 125TA4814	REF 124TA3680	REF 124TA3690	REF 124TA3697	REF 124TA3704	REF 125TA4885	REF 124TA3717	
28, 30, 32	1.1/4	1.5/8-12	1.1/2	REF 125TA5081							
35, 38	1.1/2	1.7/8-12	1.1/2	REF 125TA4816	REF 124TA3681				REF 125TA4886	REF 124TA3718	
35, 38	1.1/2	1.7/8-12	1.1/4	REF 125TA4815	REF 124TA3682				REF 125TA4887		
42		2.1/4-12	1.1/2	REF 125TA4817							

DIN 3852 adapter male metric										
Tube outer Ø		JIC thread SAE	Thread Metric							
mm	inch									
6	1/4	7/16-20	M10x1	REF 124TA3719	REF 125TA4901	REF 125TA4918	REF 125TA4931	REF 125TA4942	REF 125TA4953	
6	1/4	7/16-20	M12x1,5	REF 125TA4888	REF 125TA4902	REF 125TA4919				
8	5/16	1/2-20	M10x1,5	REF 125TA4889	REF 125TA4903	REF 125TA4920	REF 125TA4932	REF 125TA4943		
8	5/16	1/2-20	M12x1,5	REF 124TA3720	REF 125TA4904	REF 125TA4921	REF 125TA4933	REF 125TA4944	REF 125TA4954	
8	5/16	1/2-20	M14x1,5		REF 125TA4905					
10	3/8	9/16-18	M14x1,5	REF 107TA6166	REF 125TA4906	REF 125TA4922	REF 125TA4934	REF 125TA4945	REF 125TA4955	
10	3/8	9/16-18	M16x1,5	REF 125TA4890	REF 125TA4907					
10	3/8	9/16-18	M18x1,5			REF 125TA4923	REF 125TA4935	REF 125TA4946		
12	1/2	3/4-16	M14x1,5	REF 125TA4891						
12	1/2	3/4-16	M16x1,5	REF 125TA4892	REF 125TA4908	REF 125TA4924	REF 125TA4936	REF 125TA4947	REF 125TA4956	
12	1/2	3/4-16	M18x1,5	REF 125TA4893	REF 125TA4909	REF 125TA4925	REF 125TA4937	REF 125TA4948	REF 125TA4957	
14, 15, 16	5/8	7/8-14	M18x1,5	REF 125TA4894	REF 125TA4910	REF 125TA4926	REF 125TA4938	REF 125TA4949	REF 125TA4958	
14, 15, 16	5/8	7/8-14	M20x1,5		REF 125TA4911					
14, 15, 16	5/8	7/8-14	M22x1,5	REF 125TA4895	REF 125TA4912	REF 125TA4927	REF 125TA4939	REF 125TA4950	REF 125TA4959	
18, 20	3/4	1.1/16-12	M22x1,5	REF 125TA4896	REF 125TA4913	REF 125TA4928	REF 125TA4940	REF 125TA4951	REF 125TA4960	
18, 20	3/4	1.1/16-12	M27x2	REF 125TA4897	REF 125TA4914	REF 125TA4929	REF 125TA4941	REF 125TA4952	REF 125TA4961	
25	1	1.5/16-12	M33x2	REF 125TA4898	REF 125TA4915	REF 125TA4930			REF 125TA4962	
28, 30, 32	1.1/4	1.5/8-12	M42x2	REF 125TA4899	REF 125TA4916				REF 125TA4963	
35, 38	1.1/2	1.7/8-12	M48x2	REF 125TA4900	REF 125TA4917					

TRIPLE-LOK PLUS



TRIPLE-LOK PLUS

TRIPLE-LOK PLUS

UNF adapter male

Tube outer Ø		JIC thread	Thread								
mm	inch	SAE	UNF								
6	1/4	7/16-20	7/16-20	REF 107TA3680	REF 124TA3752	REF 124TA3759	REF 125TA6252	REF 124TA3787	REF 124TA3802	REF 124TA3810	REF 124TA3817
6	1/4	7/16-20	1/2-20	REF 124TA3724							
6	1/4	7/16-20	9/16-18	REF 124TA3725		REF 124TA3760					
6	1/4	7/16-20	3/4-16	REF 124TA3726							
8	5/16	1/2-20	1/2-20	REF 124TA3727		REF 124TA3761		REF 124TA3788	REF 124TA3803	REF 124TA3811	REF 124TA3818
8	5/16	1/2-20	9/16-18	REF 125TA6311		REF 125TA6251					
10	3/8	9/16-18	9/16-18	REF 107TA3668	REF 124TA3753	REF 107TA6525	REF 124TA3784	REF 124TA3789	REF 124TA3804	REF 124TA3812	REF 124TA3819
10	3/8	9/16-18	7/16-20	REF 124TA3728		REF 124TA3762					
10	3/8	9/16-18	1/2-20	REF 124TA4402		REF 124TA3763					
10	3/8	9/16-18	3/4-16	REF 124TA3729	REF 125TA4964	REF 124TA3764		REF 124TA3790			
10	3/8	9/16-18	7/8-14	REF 124TA3730		REF 124TA3765					
12	1/2	3/4-16	3/4-16	REF 113TA1676		REF 124TA3766	REF 125TA6253	REF 124TA3791	REF 124TA3805	REF 124TA3813	REF 124TA3820
12	1/2	3/4-16	9/16-18	REF 124TA3731		REF 124TA3767		REF 124TA3792			
12	1/2	3/4-16	7/8-14	REF 124TA3732	REF 124TA3755	REF 124TA3768		REF 124TA3793			
12	1/2	3/4-16	1.1/16-12	REF 124TA3733		REF 124TA3769					
14, 15, 16	5/8	7/8-14	7/8-14	REF 124TA3734	REF 124TA3755	REF 124TA3770	REF 124TA3785	REF 124TA3794	REF 124TA3806	REF 124TA3814	REF 124TA3821
14, 15, 16	5/8	7/8-14	3/4-16	REF 124TA3735		REF 124TA3771		REF 124TA3795			
14, 15, 16	5/8	7/8-14	1.1/16-12	REF 124TA3736		REF 124TA3772					
18, 20	3/4	1.1/16-12	1.1/16-12	REF 124TA3737	REF 124TA3756	REF 124TA3773	REF 124TA3786	REF 124TA3796	REF 124TA3807	REF 124TA3815	REF 124TA3822
18, 20	3/4	1.1/16-12	3/4-16	REF 124TA3738		REF 124TA3774					
18, 20	3/4	1.1/16-12	7/8-14	REF 124TA3739		REF 124TA3775		REF 124TA3797			
18, 20	3/4	1.1/16-12	1.5/16-12	REF 124TA3740		REF 124TA3776					
18, 20	3/4	1.1/16-12	1.3/16-12	REF 124TA3741		REF 124TA3777		REF 124TA3798			
22	7/8	1.1/16-12	1.5/16-12	REF 124TA3742							
25	1	1.5/16-12	1.5/16-12	REF 124TA3743	REF 124TA3757	REF 124TA3778	REF 125TA6254	REF 124TA3799	REF 124TA3808	REF 124TA3816	REF 124TA3823
25	1	1.5/16-12	7/8-14	REF 124TA3744		REF 124TA3779		REF 125TA4965			
25	1	1.5/16-12	1.1/16-12	REF 124TA3745		REF 124TA3780					
25	1	1.5/16-12	1.3/16-12	REF 124TA3746							
25	1	1.5/16-12	1.5/8-12	REF 124TA3747		REF 124TA3781					
28, 30, 32	1.1/4	1.5/8-12	1.5/8-12	REF 124TA3748	REF 124TA3758	REF 124TA3782		REF 124TA3800	REF 124TA3809		REF 124TA3824
28, 30, 32	1.1/4	1.5/8-12	1.5/16-12	REF 124TA3749							
35, 38	1.1/2	1.7/8-12	1.7/8-12	REF 124TA3750				REF 124TA3801	REF 125TA4966		REF 124TA3825
35, 38	1.1/2	1.7/8-12	1.5/8-12	REF 124TA3745							
50	2	2.1/2-12	2.1/2-12	REF 124TA3751							

ISO 6149 adapter male metric





Tube outer Ø		JIC thread	Thread							
mm	inch	SAE	Metric							
6	1/4	7/16-20	M10x1	REF 124TA3826	REF 124TA3844	REF 124TA3855	REF 125TA4976	REF 125TA4918	REF 125TA4997	REF 125TA4997
6	1/4	7/16-20	M12x1,5	REF 124TA3827	REF 124TA3845	REF 124TA3856			REF 125TA4998	REF 125TA4998
8	5/16	1/2-20	M10x1	REF 124TA3828	REF 124TA3846	REF 124TA3857	REF 125TA4977	REF 125TA4987	REF 125TA4999	REF 125TA4999
8	5/16	1/2-20	M12x1,5	REF 124TA3829	REF 124TA3847	REF 125TA4921	REF 125TA4978	REF 125TA4988	REF 125TA5000	REF 125TA5000
8	5/16	1/2-20	M14x1,5	REF 124TA3830	REF 124TA3848					
10	3/8	9/16-18	M12x1,5		REF 125TA6256					
10	3/8	9/16-18	M14x1,5	REF 107TA6166	REF 124TA3849	REF 124TA3858	REF 125TA4979	REF 125TA4989	REF 125TA5001	REF 125TA5001
10	3/8	9/16-18	M16x1,5	REF 124TA3831						
10	3/8	9/16-18	M18x1,5	REF 124TA3832	REF 125TA6257	REF 125TA4968	REF 125TA4980	REF 125TA4990		
12	1/2	3/4-16	M14x1	REF 125TA6255						
12	1/2	3/4-16	M16x1,5	REF 124TA3833	REF 124TA3850	REF 125TA4969	REF 125TA4981	REF 125TA4991	REF 125TA5003	REF 125TA5003
12	1/2	3/4-16	M18x1,5	REF 124TA3834	REF 124TA3851	REF 125TA4970	REF 125TA4982	REF 125TA4992	REF 125TA5004	REF 125TA5004
14, 15, 16	5/8	7/8-14	M18x1,5	REF 124TA3835	REF 124TA3852	REF 125TA4971	REF 125TA4983	REF 125TA4949	REF 125TA5005	REF 125TA5005
14, 15, 16	5/8	7/8-14	M22x1,5	REF 124TA3836	REF 125TA6258	REF 125TA4972	REF 125TA4984	REF 125TA4994	REF 124TA3860	REF 124TA3860
14, 15, 16	5/8	7/8-14	M27x2	REF 124TA3837						
18, 20	3/4	1.1/16-12	M22x1,5	REF 124TA3838	REF 124TA3853	REF 125TA4973	REF 125TA4985	REF 125TA4995	REF 125TA5006	REF 125TA5006
18, 20	3/4	1.1/16-12	M27x2	REF 124TA3839	REF 124TA3854	REF 125TA4974	REF 125TA4986	REF 125TA4996	REF 125TA5007	REF 125TA5007
25	1	1.5/16-12	M27x2	REF 124TA3840						
25	1	1.5/16-12	M33x2	REF 124TA3841	REF 125TA6259	REF 125TA4975			REF 125TA5008	REF 125TA5008
28, 30, 32	1.1/4	1.5/8-12	M42x2	REF 124TA3842	REF 125TA6260				REF 125TA5009	REF 125TA5009
35, 38	1.1/2	1.7/8-12	M48x2	REF 124TA3843	REF 125TA6261				REF 125TA5010	REF 125TA5010





NPTF adapter female



Tube outer Ø		JIC thread	Thread						
mm	inch	SAE	NPTF						
6	1/4	7/16-20	1/8	REF 124TA3861	REF 124TA3877	REF 124TA3883	REF 124TA3898	REF 124TA3907	REF 125TA5012
6	1/4	7/16-20	1/4	REF 124TA3862		REF 124TA3884			
8	5/16	1/2-20	1/8	REF 124TA3863		REF 124TA3885	REF 124TA3899		REF 125TA5013
8	5/16	1/2-20	1/4	REF 124TA3864		REF 124TA3886			
10	3/8	9/16-18	1/8			REF 124TA3887			
10	3/8	9/16-18	1/4	REF 124TA3865	REF 124TA3878	REF 124TA3888	REF 124TA3900	REF 124TA3908	REF 125TA5014
10	3/8	9/16-18	3/8	REF 124TA3866		REF 124TA3889			
12	1/2	3/4-16	1/4			REF 124TA3890			
12	1/2	3/4-16	3/8	REF 124TA3867	REF 124TA3879	REF 124TA3891	REF 124TA3901	REF 124TA3909	REF 125TA5015
12	1/2	3/4-16	1/2	REF 124TA3868					
14, 15, 16	5/8	7/8-14	3/8	REF 125TA5011		REF 124TA3892			
14, 15, 16	5/8	7/8-14	1/2	REF 124TA3869	REF 124TA3880	REF 124TA3893	REF 124TA3902	REF 124TA3910	REF 125TA5016
18, 20	3/4	1.1/16-12	1/2	REF 124TA3870		REF 124TA3894			
18, 20	3/4	1.1/16-12	3/4	REF 124TA3871	REF 124TA3881		REF 124TA3903	REF 124TA3911	REF 125TA5017
22	7/8	1.3/16-12	3/4	REF 124TA3872		REF 124TA3895			
25	1	1.5/16-12	1	REF 124TA3873	REF 124TA3882	REF 124TA3896	REF 124TA3904	REF 124TA3912	REF 125TA5018
28, 30, 32	1.1/4	1.5/8-12	1.1/4	REF 124TA3874		REF 124TA3897	REF 124TA3905	REF 124TA3913	REF 125TA5019
35, 38	1.1/2	1.7/8-12	1.1/2	REF 124TA3875			REF 124TA3906		REF 125TA5020
50	2	2.1/2-12	2	REF 124TA3876					







TRIPLE-LOK PLUS



Tube - tube										
Tube outer Ø 1		Tube outer Ø 2		JIC thread SAE						
mm	inch	mm	inch	1	2					
6	1/4	6	1/4	7/16-20	7/16-20	REF 124TA3914	REF 124TA3931	REF 124TA3938	REF 124TA3950	REF 124TA3961
8	5/16	8	5/16	1/2-20	1/2-20	REF 124TA3915	REF 124TA3932	REF 124TA3939	REF 124TA3951	
10	3/8	10	3/8	9/16-18	9/16-18	REF 124TA3916	REF 124TA3933	REF 124TA3940	REF 124TA3952	REF 124TA3962
10	3/8	6	1/4	9/16-18	7/16-20	REF 124TA3917	REF 125TA5022			
12	1/2	12	1/2	3/4-16	3/4-16	REF 124TA3918	REF 124TA3934	REF 124TA3941	REF 124TA3953	REF 124TA3963
12	1/2	6	1/4	3/4-16	7/16-20		REF 125TA5023			
12	1/2	10	3/8	3/4-16	9/16-18	REF 124TA3919	REF 125TA5024			
14, 15, 16	5/8	14, 15, 16	5/8	7/8-14	7/8-14	REF 124TA3920	REF 124TA3935	REF 124TA3942	REF 124TA3954	REF 124TA3964
14, 15, 16	5/8	12	1/2	7/8-14	3/4-16	REF 124TA3921				
18, 20	3/4	18, 20	3/4	1.1/16-12	1.1/16-12	REF 124TA3922	REF 124TA3936	REF 124TA3943	REF 124TA3955	REF 124TA3965
18, 20	3/4	12	1/2	1.1/16-12	3/4-16	REF 124TA3923				
18, 20	3/4	25	1	1.1/16-12	7/8-14	REF 124TA3924				
22	7/8	22	7/8	1.3/16-12	1.3/16-12	REF 124TA3925		REF 124TA3944	REF 124TA3956	
25	1	25	1	1.5/16-12	1.5/16-12	REF 124TA3926	REF 124TA3937	REF 124TA3945	REF 124TA3957	REF 124TA3966
25	1	18, 20	3/4	1.5/16-12	1.1/16-12	REF 124TA3927				
28, 30, 32	1.1/4	30, 32	1.1/4	1.5/8-12	1.5/8-12	REF 124TA3928		REF 124TA3946	REF 124TA3958	
35, 38	1.1/2	38	1.1/2	1.7/8-12	1.7/8-12	REF 124TA3929		REF 124TA3947	REF 124TA3959	
42		42		2.1/4-12	2.1/4-12	REF 125TA5021		REF 124TA3948	REF 124TA3960	
50	2	50	2	2.1/2-12	2.1/2-12	REF 124TA3930		REF 124TA3949		



Couplings male - male							
Tube outer Ø		JIC thread SAE					
mm	inch						
6	1/4	7/16-20	REF 124TA3967	REF 124TA3975	REF 124TA3984	REF 124TA3992	REF 124TA3997
8	5/16	1/2-20	REF 124TA3968	REF 124TA3976	REF 124TA3985		
10	3/8	9/16-18	REF 107TA3749	REF 124TA3977	REF 124TA3986	REF 124TA3993	REF 124TA3998
12	1/2	3/4-16	REF 107TA3745	REF 124TA3978	REF 124TA3987	REF 124TA3994	REF 124TA3999
14, 15, 16	5/8	7/8-14	REF 124TA3969	REF 124TA3979	REF 124TA3988	REF 124TA3995	REF 124TA4000
18, 20	3/4	1.1/16-12	REF 124TA3970	REF 124TA3980	REF 124TA3989	REF 124TA3996	REF 124TA4001
22	7/8	1.3/16-12	REF 124TA3971	REF 124TA3981			
25	1	1.5/16-12	REF 124TA3972	REF 124TA3982	REF 124TA3990		
28, 30, 32	1.1/4	1.5/8-12	REF 124TA3973	REF 124TA3983	REF 124TA3991		
35, 38	1.1/2	1.7/8-12	REF 124TA3974		REF 124TA4002		



Check valves						
Tube outer Ø		JIC thread SAE	Thread BSPP			
mm	inch					
6	1/4	7/16-20	1/8	REF 125TA5025	REF 125TA5034	REF 125TA5043
8	5/16	1/2-20	1/4	REF 125TA5026	REF 125TA5035	REF 125TA5044
10	3/8	9/16-18	1/4	REF 125TA5027	REF 125TA5036	REF 125TA5045
12	1/2	3/4-16	3/8	REF 125TA5028	REF 125TA5037	REF 125TA5046
14, 15, 16	5/8	7/8-14	1/2	REF 125TA5029	REF 125TA5038	REF 125TA5047
18, 20	3/4	1.1/16-12	3/4	REF 125TA5030	REF 125TA5039	REF 125TA5048
25	1	1.5/16-12	1	REF 125TA5031	REF 125TA5040	REF 125TA5049
28, 30, 32	1.1/4	1.5/8-12	1.1/4	REF 125TA5032	REF 125TA5041	REF 125TA5050
35, 38	1.1/2	1.7/8-12	1.1/2	REF 125TA5033	REF 125TA5042	REF 125TA5051

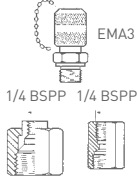

Swivel couplings						
Tube outer Ø		JIC thread SAE				
mm	inch					
6	1/4	7/16-20	REF 124TA4003	REF 124TA4013	REF 124TA4023	REF 124TA4032
8	5/16	1/2-20	REF 124TA4004	REF 124TA4014	REF 124TA4024	
10	3/8	9/16-18	REF 124TA4005	REF 124TA4015	REF 124TA4025	REF 124TA4033
12	1/2	3/4-16	REF 124TA4006	REF 124TA4016	REF 124TA4026	REF 124TA4034
14, 15, 16	5/8	7/8-14	REF 124TA4007	REF 124TA4017	REF 124TA4027	REF 124TA4035
18, 20	3/4	1.1/16-12	REF 124TA4008	REF 124TA4018	REF 124TA4028	REF 124TA4036
22	7/8	1.3/16-12	REF 124TA4009	REF 124TA4019	REF 124TA4029	
25	1	1.5/16-12	REF 124TA4010	REF 124TA4020	REF 124TA4030	REF 124TA4037
28, 30, 32	1.1/4	1.5/8-12	REF 124TA4011	REF 124TA4021	REF 124TA4031	REF 124TA4038
35, 38	1.1/2	1.7/8-12	REF 124TA4012	REF 124TA4022		

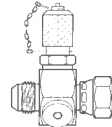





TRIPLE-LOK PLUS						1 	1 		
Reducers								Type 1	Type 2
Tube outer Ø 1		Tube outer Ø 2		JIC thread SAE					
mm	inch	mm	inch	1	2				
8	5/16	6	1/4	1/2-20	7/16-20		REF 124TA4055		
10	3/8	6	1/4	9/16-18	7/16-20	REF 124TA4039			
10	3/8	8	5/16	9/16-18	1/2-20		REF 124TA4056		
12	1/2	6	1/4	3/4-16	7/16-20	REF 124TA4040			
12	1/2	8	5/16	3/4-16	1/2-20	REF 124TA4041			
12	1/2	10	3/8	3/4-16	9/16-18	REF 124TA4042			
14, 15, 16	5/8	6	1/4	7/8-14	7/16-20	REF 124TA4043			
14, 15, 16	5/8	10	3/8	7/8-14	9/16-18	REF 124TA4044			
14, 15, 16	5/8	12	1/2	7/8-14	3/4-16		REF 124TA4057		
18, 20	3/4	6	1/4	1.1/16-12	7/16-20	REF 124TA4045			
18, 20	3/4	10	3/8	1.1/16-12	9/16-18	REF 124TA4046			
18, 20	3/4	12	1/2	1.1/16-12	3/4-16	REF 124TA4047			
18, 20	3/4	14, 15, 16	5/8	1.1/16-12	7/8-14		REF 124TA4058		
22	7/8	18, 20	3/4	1.3/16-12	1.1/16-12		REF 124TA4059		
25	1	12	1/2	1.5/16-12	3/4-14	REF 124TA4048			
25	1	14, 15, 16	5/8	1.5/16-12	7/8-14	REF 124TA4049			
25	1	18, 20	3/4	1.5/16-12	1.1/16-12	REF 124TA4050			
25	1	22	7/8	1.5/16-12	1.3/16-12	REF 124TA4051			
28, 30, 32	1.1/4	18, 20	3/4	1.7/8-12	1.1/16-12	REF 124TA4052			
28, 30, 32	1.1/4	22	7/8	1.7/8-12	1.3/16-12	REF 125TA5052			
28, 30, 32	1.1/4	25	1	1.7/8-12	1.5/16-12	REF 124TA4053			
35, 38	1.1/2	28, 30, 32	1.1/4	1.7/8-12	1.5/8-12	REF 124TA4054			
42		35, 38		2.1/4-12	1.7/8-12	REF 125TA5053			

Pressure coupling								
Tube outer Ø		JIC thread SAE	Thread BSPP		1/4 BSPP	1/4 BSPP		
mm	inch							
6	1/4	7/16-20	1/4	REF 124TA4060	REF 125TA5054	REF 125TA5055		
6	1/4	7/16-20	1/2	REF 124TA4061				
8	5/16	1/2-20	1/4	REF 124TA4062	REF 124TA4068	REF 125TA5056	REF 125TA5064	REF 125TA5069
8	5/16	1/2-20	1/2	REF 124TA4063				
10	3/8	9/16-18	1/4	REF 124TA4064	REF 124TA4069	REF 125TA5057		
10	3/8	9/16-18	1/2	REF 124TA4065				
12	1/2	3/4-16	1/4	REF 124TA4066	REF 124TA4070	REF 125TA5058	REF 125TA5065	REF 125TA5070
12	1/2	3/4-16	1/2	REF 124TA4067				
14, 15, 16	5/8	7/8-14	1/4		REF 124TA4071	REF 125TA5059	REF 125TA5066	REF 125TA5071
18, 20	3/4	1.1/16-12	1/4	REF 124TA4072	REF 124TA4072	REF 125TA5060	REF 125TA5067	REF 125TA5072
25	1	1.5/16-12	1/4	REF 124TA4073	REF 124TA4073	REF 125TA5061	REF 125TA5068	REF 125TA5073
28, 30, 32	1.1/4	1.5/8-12	1/4	REF 124TA4074	REF 124TA4074	REF 125TA5062		
35, 38	1.1/2	1.7/8-12	1/4	REF 124TA4075	REF 124TA4075	REF 125TA5063		

Fitting			
Tube outer Ø		Fitting metric	Fitting inch
mm	inch		
6	1/4	REF 124TA4076	REF 124TA4091
8	5/16	REF 124TA4077	REF 124TA4077
10	3/8	REF 124TA4078	REF 124TA4092
12	1/2	REF 124TA4079	REF 124TA4093
14	3/8	REF 124TA4080	
15	3/8	REF 124TA4081	
16	5/8	REF 124TA4082	REF 124TA4094
18	1/2	REF 124TA4083	
20	3/4	REF 124TA4084	REF 124TA4095
22	7/8	REF 124TA4085	REF 124TA4096
25	1	REF 124TA4086	REF 124TA4086
28	1.1/4	REF 125TA5074	
30		REF 124TA4087	
32	1.1/4	REF 124TA4088	REF 124TA4097
35		REF 125TA5075	
38	1.1/2	REF 124TA4089	REF 124TA4098
42		REF 124TA4090	
50	2		REF 124TA4099

Nuts				
JIC thread SAE	Hexagonal nut metric	Hexagonal nut inch	Locknut	
7/16-20	REF 124TA4100	REF 124TA4108	REF 124TA4115	
1/2-20	REF 124TA4101	REF 124TA4109	REF 124TA4116	
9/16-18	REF 124TA4102	REF 124TA4100	REF 124TA4117	
3/4-16	REF 124TA4103	REF 124TA4103	REF 124TA4118	
7/8-14	REF 124TA4104			
7/8-14	REF 124TA4104			
7/8-14	REF 124TA4104	REF 124TA4110	REF 124TA4119	
1.1/16-12	REF 124TA4105			
1.1/16-12	REF 124TA4105	REF 124TA4111	REF 124TA4120	
1.3/16-12	REF 124TA4106	REF 124TA4112	REF 124TA4121	
1.5/16-12	REF 124TA4106	REF 124TA4125	REF 124TA4122	
1.5/8-12	REF 124TA4107			
1.5/8-12	REF 124TA4107			
1.5/8-12	REF 124TA4107	REF 125TA5078	REF 124TA4123	
1.7/8-12	REF 125TA5076			
1.7/8-12	REF 125TA5076	REF 124TA4113	REF 124TA4124	
2.1/2-12	REF 125TA5077	REF 124TA4114		

Various accessories							
Tube outer Ø		JIC thread SAE	Plug female	Plug male	Adapter Triple-Lok/O-Lok	Adapter Triple-Lok/O-Lok swiveling	Adapter O-Lok/Triple-Lok swiveling
mm	inch						
6	1/4	7/16-20	REF 124TA4126	REF 124TA4137	REF 124TA4148	REF 124TA4156	REF 124TA4162
8	5/16	1/2-20	REF 124TA4127	REF 124TA4138			
10	3/8	9/16-18	REF 124TA4128	REF 124TA4139	REF 124TA4149	REF 124TA4157	REF 124TA4163
12	1/2	3/4-16	REF 124TA4129	REF 124TA4140	REF 124TA4150	REF 124TA4158	REF 124TA4164
14, 15, 16	5/8	7/8-14	REF 124TA4130	REF 124TA4141	REF 124TA4151	REF 124TA4159	REF 124TA4168
18, 20	3/4	1.1/16-12	REF 124TA4131	REF 124TA4142	REF 124TA4152	REF 124TA4160	REF 124TA4165
22	7/8	1.3/16-12	REF 124TA4132	REF 124TA4143			
25	1	1.5/16-12	REF 124TA4133	REF 124TA4144	REF 124TA4153		
28, 30, 32	1.1/4	1.5/8-12	REF 124TA4134	REF 124TA4145	REF 124TA4154	REF 124TA4161	REF 124TA4166
35, 38	1.1/2	1.7/8-12	REF 124TA4135	REF 124TA4146	REF 124TA4155		
50	2	2.1/2-12	REF 124TA4136	REF 124TA4147			



20

**PROTECTIVE
COVERS**





TECHNICAL DETAIL: PROTECTIVE COVERS

Group
08-01-06-00

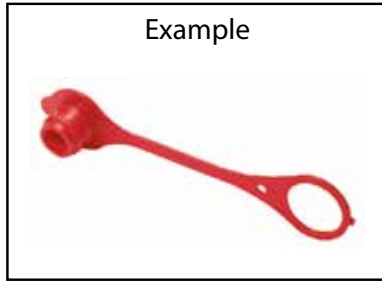

Customer details

Type machine:

Price inquiry

Serial n° machine:

Order

CODE: TY x D1 x D3 x H1 x H2 x TA1 x Ml x Pi x Pm x RH/LH x D x D2 x D4 x L x W x H x COL



- TY..... Type.
- D1 Diameter 1, see figure (mm).
- D3 Diameter 3, see figure (mm).
- H1 Height, see figure (mm).
- H2 Height, see figure (mm).
- TA1 Thread.
- Ml..... Thread type: metric/inch.
- Pi Pitch.
- Pm..... Imperial pitch.
- RH/LH..... RH/LH.
- D..... Maximum diameter (mm).
- D2 Diameter, see figure (mm).
- D4 Diameter, see figure (mm)
- L..... Length (mm).
- W..... Width (mm).
- H..... Maximum height (mm).
- COL..... Colour.



TECHNICAL DETAIL: PROTECTIVE COVERS

TYPES

TY-A



TY-B



TY-C



TY-D



TY-E1



TY-E2



TY-F



TY-G



TY-H



TY-I





TECHNICAL DETAIL: PROTECTIVE COVERS

DIMENSIONS

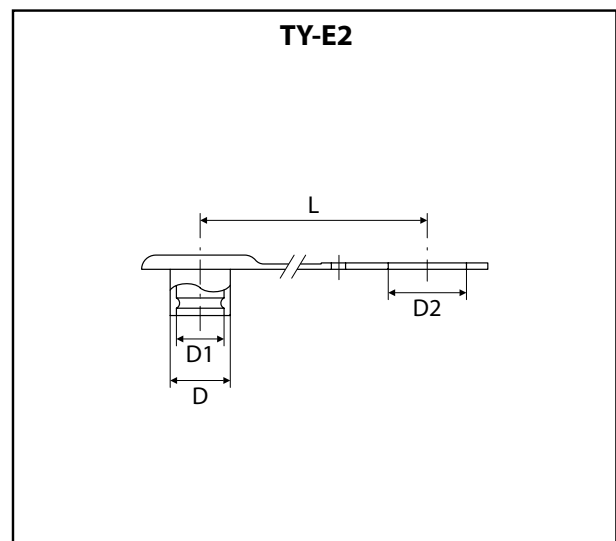
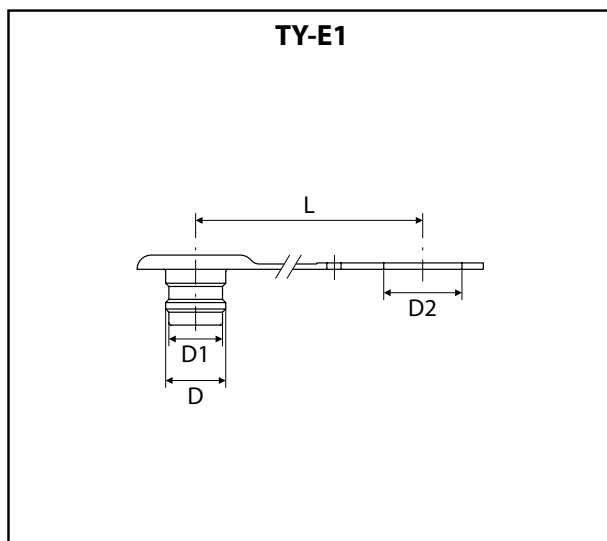
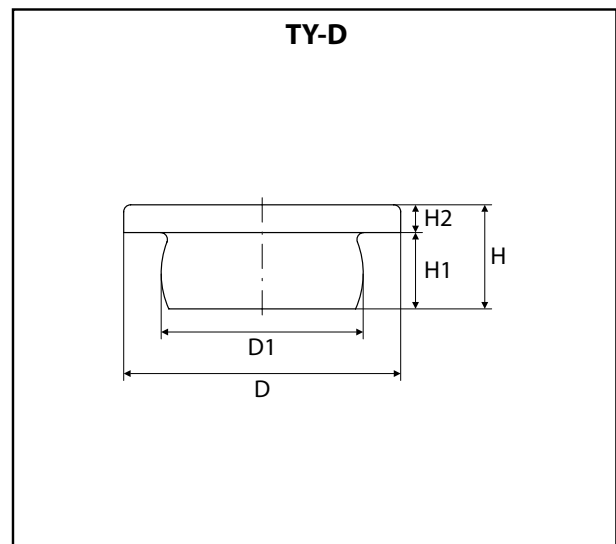
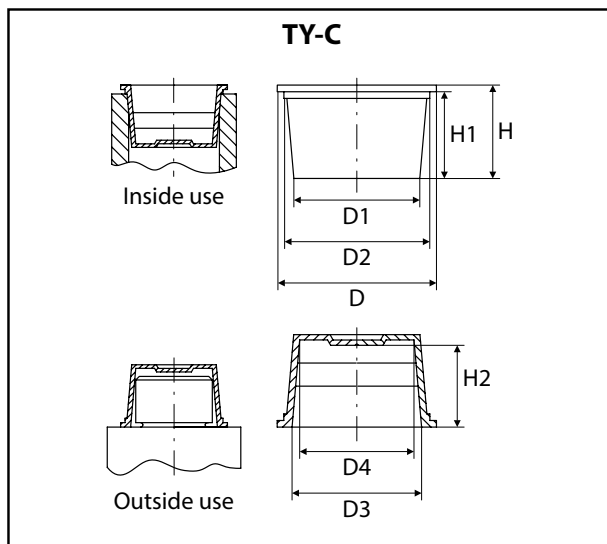
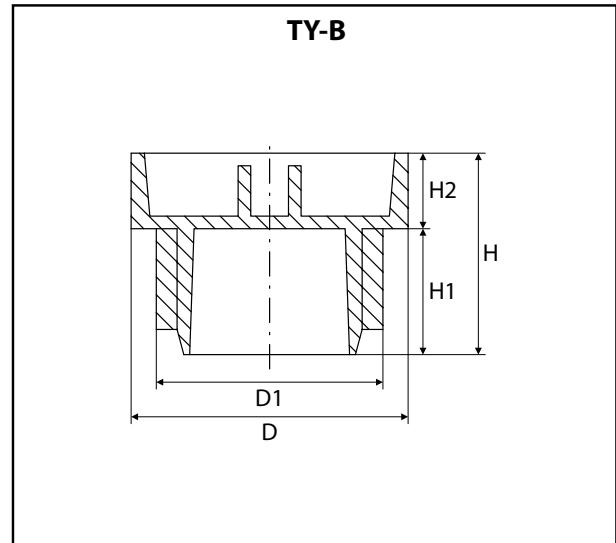
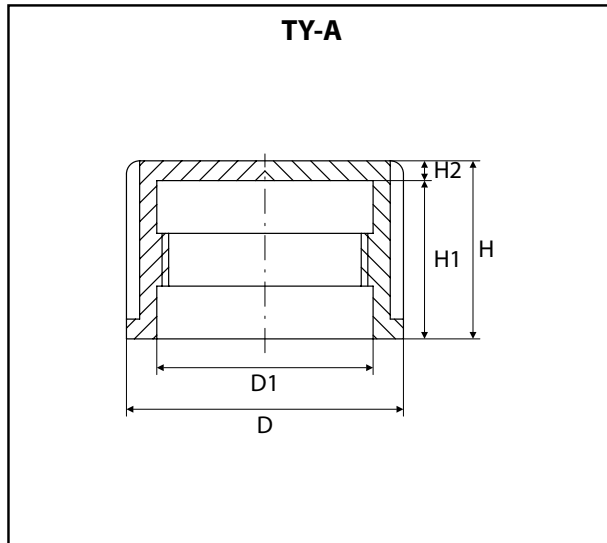



TECHNICAL DETAIL: PROTECTIVE COVERS

DIMENSIONS

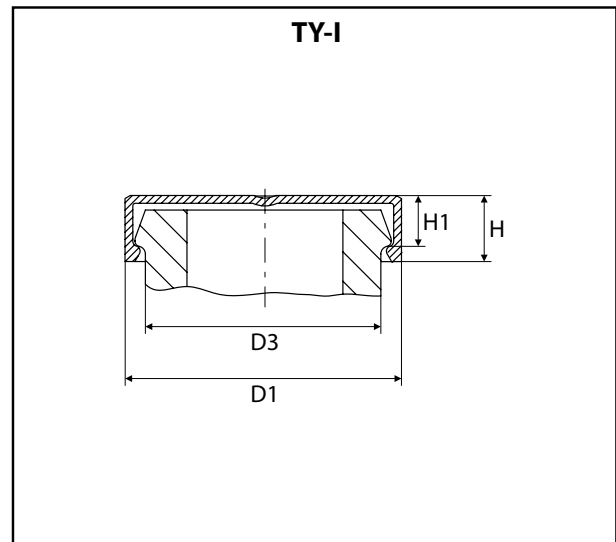
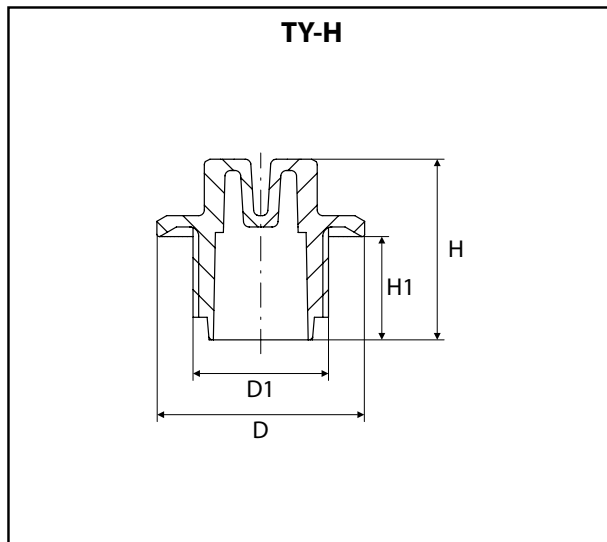
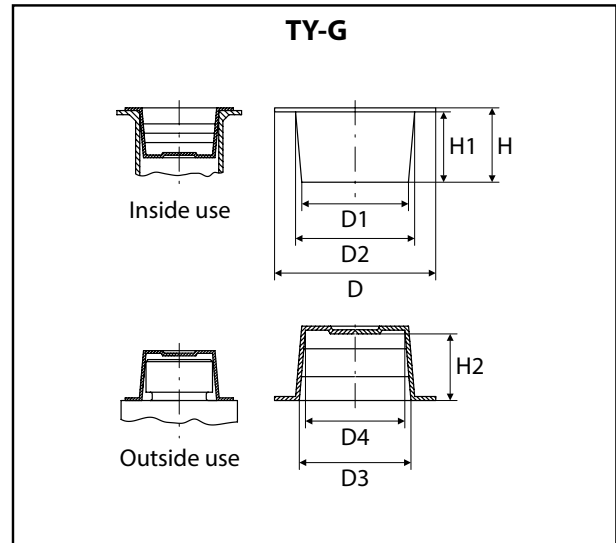
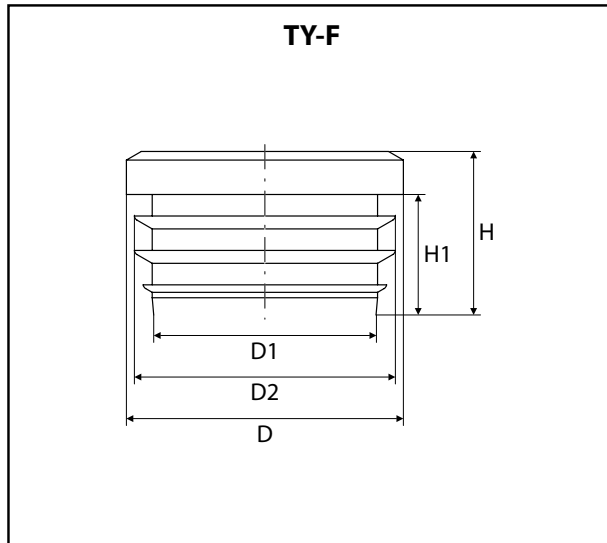



TECHNICAL DETAIL: PROTECTIVE COVERS

Groep
08-01-06-00



Gegevens klant

Type machine:

Prijsaanvraag

Serienr. machine:

Bestelling

CODE: TY x D1 x D3 x H1 x H2 x TA1 x MI x Pi x Pm x RH/LH x D x D2 x D4 x L x W x H x COL



- TY..... Type.
- D1 Diameter 1, zie figuur (mm).
- D3 Diameter 3, zie figuur (mm).
- H1 Hoogte, zie figuur (mm).
- H2 Hoogte, zie figuur (mm).
- TA1 Schroefdraad.
- MI..... Schroefdraad type: metrisch/inch.
- Pi Spoed.
- Pm..... Aantal gangen.
- RH/LH..... RH/LH.
- D..... Grootste diameter (mm).
- D2 Diameter, zie figuur (mm).
- D4 Diameter, zie figuur (mm).
- L..... Lengte (mm).
- W..... Breedte (mm).
- H..... Maximale hoogte (mm).
- COL..... Kleur.

zie Engelse technische fiche !



TECHNICAL DETAIL: PROTECTIVE COVERS

Groupe
08-01-06-00

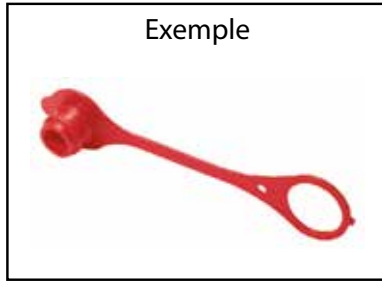

Données client

Type machine :

Demande de prix

No. série machine :

Commande

CODE : TY x D1 x D3 x H1 x H2 x TA1 x Ml x Pi x Pm x RH/LH x D x D2 x D4 x L x W x H x COL



- TY..... Type.
- D1 Diamètre 1, voir figure (mm).
- D3 Diamètre 3, voir figure (mm).
- H1 Hauteur, voir figure (mm).
- H2 Hauteur, voir figure (mm).
- TA1 Filetage.
- Ml..... Filetage type : métrique / pouce.
- Pi Pas.
- Pm..... Nombre de filets.
- RH/LH..... Droite / gauche.
- D..... Diamètre supérieur (mm).
- D2 Diamètre, voir figure (mm).
- D4 Diamètre, voir figure (mm).
- L..... Longueur (mm).
- W..... Largeur (mm).
- H..... Hauteur maximale (mm).
- COL..... Couleur.

voir la fiche technique en Anglais.



TECHNICAL DETAIL: PROTECTIVE COVERS

Gruppe
08-01-06-00



Kundendaten

Maschinentyp:

Preis Anfrage

Serien-Nr. Maschine:

Bestellung

CODE: TY x D1 x D3 x H1 x H2 x TA1 x MI x Pi x Pm x RH/LH x D x D2 x D4 x L x W x H x COL



- TY..... Typ.
- D1 Durchmesser 1, siehe Figur (mm).
- D3 Durchmesser 3, siehe Figur (mm).
- H1 Höhe, siehe Figur (mm).
- H2 Höhe, siehe Figur (mm).
- TA1 Gewinde.
- MI..... Gewindetyp: Metrisch/Inch.
- Pi Steigung.
- Pm..... Anzahl Gänge.
- RH/LH..... RH/LH.
- D..... Größter Durchmesser (mm).
- D2 Durchmesser, siehe Figur (mm).
- D4 Durchmesser, siehe Figur (mm).
- L..... Länge (mm).
- W..... Breite (mm).
- H..... Maximum Höhe (mm).
- COL..... Farbe.

Siehe technische Datenblätter auf Englisch.



TYPE A

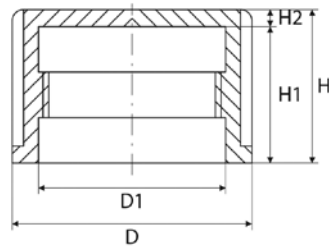

Thread	Metric/inch	Imperial pitch	Pitch	D (mm)	D1 (mm)	H (mm)	H1 (mm)	H2 (mm)	REF
M8	M		1	12	8	9	8	1	107TA5695
M8	M		1,25	12	8	9	8	1	107TA5684
M10	M		1	14	10	9	8	1	107TA5696
M10	M		1,5	14	10	9	8	1	107TA5685
M12	M		1	16	12	13,5	12	1,5	107TA5697
M12	M		1,5	16	12	13,5	12	1,5	107TA5698
M12	M		1,75	16	12	13,5	12	1,5	107TA5686
M14	M		1,5	18	14	13,5	12	1,5	107TA5699
M14	M		2	18	14	13,5	12	1,5	107TA5687
M16	M		1,5	21	16	13,5	12	1,5	152TA1942
M16	M		2	21	16	13,5	12	1,5	107TA5688
M18	M		1,5	22	18	13,5	12	1,5	107TA5701
M18	M		2	22	18	13,5	12	1,5	107TA5713
M18	M		2,5	22	18	13,5	12	1,5	107TA5689
M20	M		1,5	25	20	15,5	14	1,5	107TA5702
M20	M		2	25	20	15,5	14	1,5	107TA5714
M20	M		2,5	25	20	15,5	14	1,5	107TA5690
M22	M		1,5	28	22	15,5	14	1,5	107TA5703
M22	M		2	28	22	15,5	14	1,5	107TA5715
M22	M		2,5	28	22	15,5	14	1,5	107TA5691
M23	M		1,5	29	23	23	22	1	107TA5704
M24	M		1,5	30	24	15,5	14	1,5	107TA5705
M24	M		3	32	24	16	14	2	107TA5692
M25	M		1,5	33	25	16	14	2	107TA5706
M26	M		1,5	34	26	13,5	11	2,5	107TA5707
M27	M		3	35	27	16	14	2	107TA5693
M28	M		1,5	34,5	28	30	28	2	107TA5708
M30	M		1,5	36	30	15,5	14	1,5	107TA5709
M30	M		2	38	30	16	14	2	107TA5716
M30	M		3,5	38	30	16	14	2	107TA5694
M36	M		1,5	44	36	19	17	2	107TA5710
M36	M		2	44	36	19	17	2	107TA5717
M42	M		2	50	42	17	15	2	107TA5718
M45	M		1,5	53	45	17	15	2	107TA5711
M45	M		2	53	45	17	15	2	107TA5719
M52	M		2	60	52	17	15	2	107TA5720
M55	M		1,5	63	55	18	16	2	107TA5712



TYPE A

Thread	Metric/inch	Imperial pitch	Pitch	D (mm)	D1 (mm)	H (mm)	H1 (mm)	H2 (mm)	REF
1/4 UNF	I	28		12	6,35	9	8	1	107TA5766
5/16 UNF	I	24		12	7,94	9	8	1	107TA5767
7/16 UNF	I	20		15	11,11	13,5	12	1,5	107TA5768
1/2 UNF	I	20		18	12,7	16,5	15	1,5	107TA5769
9/16 UNEF	I	24		18	14,29	13	12	1	107TA5771
9/16 UNF	I	18		18	14,29	20	18	2	107TA5770
5/8 UNF	I	18	19,3	19,3	15,88	13,5	12	1,5	107TA5772
3/4 UNF	I	16		24	19,05	15	14,2	0,8	107TA5773
7/8 UNF	I	14		27	22,23	19,5	18	1,5	107TA5774
15/16 UNEF	I	20		29	23,81	21,5	20	1,5	107TA5775
1"1/16 UNF	I	12		34,5	26,99	16	14	2	107TA5778
1"1/16 UNEF	I	16		34,5	26,99	25	23	2	107TA5779
1"1/8 UNF	I	12		60	53,98	19	17	2	107TA5790
1"1/8 UNEF	I	16		60	53,98	20	18	2	107TA5791
1"3/16 UNEF	I	20		38	30,16	16	14	2	107TA5780
1"1/4 UNF	I	12		38	31,75	16	14	2	107TA5781
1"1/4 UNEF	I	14		33	25,4	16	14	2	107TA5776
1"5/16 UNF	I	12		40	33,34	16	14	2	107TA5782
1"3/8 UNF	I	16		69	60,32	20	18	2	107TA5793
1"7/16 UNEF	I	18		44	36,51	26	24	2	107TA5783
1"5/8 UNF	I	12		50	41,29	19	17	2	107TA5784
1"5/8 UNEF	I	16		50	41,29	19	17	2	107TA5785
1"3/4 UNEF	I	16		53	44,45	19	17	2	107TA5786
1"13/16 UNF	I	16		53	46,04	19	17	2	107TA5787
1"7/8 UNF	I	12		55	47,63	19	17	2	107TA5788
1"7/8 UNEF	I	18		55	47,63	19	17	2	107TA5789
2"1/4 UNF	I	12		66	57,15	20	18	2	107TA5792
2"1/2 UNF	I	12		72	63,5	20	18	2	107TA5794
2"1/2 UNEF	I	16		72	63,5	20	18	2	107TA5795
G1/8	I	28		14	8,57	9	8		134TA2413
G1/4	I	19		18	11,44	13,5	12		134TA2414
G3/8	I	19		21	14,95	13,5	12		134TA2415
G1/2	I	14		25	18,63	15,5	14		134TA2416
G5/8	I	14		28	20,56	15,5	14		134TA2417
G3/4	I	14		32	24,12	16	14		134TA2418
G1	I	11		39	30,3	16	14		134TA2419
G1"1/4	I	11		47,7	38,95	19,7	17,7		134TA2420
G1"1/2	I	11		56	44,85	19,7	17		134TA2421
G2	I	11		68	56,67	20	18		134TA2422
G2"1/2	I	11		80,9	72,23	20	18		134TA2423



TYPE B

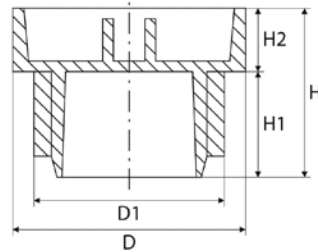

Thread	Metric/inch	Imperial pitch	Pitch	D (mm)	D1 (mm)	H (mm)	H1 (mm)	H2 (mm)	REF
M6	M	0,75		12	6	12	7	5	107TA5645
M6	M	1		12	6	12	7	5	107TA5644
M8	M	1		12	8	12	7	5	107TA5655
M8	M	1,25		12	8	12	7	5	107TA5646
M10	M	1		14	10	14	9	5	107TA5656
M10	M	1,5		14	10	14	9	5	107TA5647
M12	M	1		16	12	14	9	5	107TA5657
M12	M	1,5		16	12	14	9	5	107TA5659
M12	M	1,75		16	12	14	9	5	107TA5648
M14	M	1		19	14	14	9	5	107TA5658
M14	M	1,5		19	14	14	9	5	107TA5660
M14	M	2		19	14	14	9	5	107TA5649
M16	M	1,5		21	16	16	10	6	107TA5661
M16	M	2		21	16	16	10	6	107TA5650
M18	M	1,5		24	18	16	10	6	107TA5662
M18	M	2		24			10	6	107TA5673
M18	M	2,5		24	18	16	10	6	107TA5651
M20	M	1,5		26	20	18	12	6	107TA5663
M20	M	2		26	20	18	12	6	107TA5674
M20	M	2,5		26	20	18	12	6	107TA5652
M22	M	1,5		28	22	18	12	6	107TA5664
M22	M	2		28			12	6	107TA5675
M24	M	1,5		31,5	24	18	10	8	152TA1944
M24	M	2		31,5	24	18	10	8	107TA5676
M24	M	3		32	24	18	10	8	107TA5654
M26	M	1,5		31,5	26	20	12	8	107TA5666
M27	M	2		32			12	8	107TA5677
M30	M	1,5		36	30	20	12	8	107TA5667
M30	M	2		36	30	20	12	8	107TA5678
M33	M	2		39	33	23	13	10	107TA5679
M34	M	1,5		42			13	10	107TA5668
M36	M	1,5		44	36	23	13	10	107TA5669
M36	M	2		44	36	23	13	10	107TA5680
M42	M	1,5		52	42	25	15	10	107TA5670
M42	M	2		52	42	25	15	10	107TA5681
M45	M	1,5		55	45	25	15	10	107TA5671
M45	M	2		55	45	25	15	10	152TA1945



TYPE B

Thread	Metric/inch	Imperial pitch	Pitch	D (mm)	D1 (mm)	H (mm)	H1 (mm)	H2 (mm)	REF
M52	M	1,5		60	52	25	15	10	107TA5672
M52	M	2		60	52	25	15	10	107TA5683
1/4 UNF	I		28	12			7	5	107TA7790
3/8 UNF	I		24	14	9,5	30	18	12	107TA8346
7/16 UNF	I		20	16	11,11	14	9	5	107TA7791
1/2 UNF	I		20	16	12,7	14	9	5	107TA7792
9/16 UNEF	I		24	19	14,29	14	9	5	107TA7794
9/16 UNF	I		18	19	14,29	14	9	5	107TA7793
5/8 UNF	I		18	21	15,88	14	9	5	107TA7795
5/8 UNEF	I		24	21	15,88	16	10	6	107TA7796
3/4 UNEF	I		20	24	19,05	30	18	12	107TA7964
3/4 UNF	I		16	26	19,05	16	10	6	107TA7797
7/8 UNEF	I		14	28	22,23	18	12	6	107TA7800
7/8 UNF	I		9	28	22,23	22	16	6	107TA7799
15/16 UNEF	I		20	32	23,81	18	12	6	107TA7801
1" UNS	I		16	32	25,4	18	10	8	107TA7803
1" UNEF	I		14	32	25,4	18	12	6	107TA7802
1"1/16 UN	I		16	32	26,99	20	12	8	107TA7805
1"1/16 UN	I		12	32	26,99	30	18	12	107TA7965
1"3/16 UNEF	I		20	36	30,16	18	10	8	107TA7806
1"1/4 UNF	I		12	36	31,75	20	12	8	107TA7807
1"5/16 UNF	I		12	42	33,34	20	12	8	107TA7808
1"3/8 UNEF	I		18	42	34,93	20	12	8	107TA7809
1"7/16 UNEF	I		18	44	36,51	20	12	8	107TA7810
1"5/8 UNF	I		12	52	41,29	23	13	10	107TA7811
1"5/8 UNEF	I		16	52	41,29	23	13	10	107TA7812
1"3/4 UNEF	I		16	55	44,45	23	13	10	107TA7813
1"13/16 UNEF	I		16	55	46,04	25	15	10	107TA7814
1"7/8 UNF	I		12	57	47,63	25	15	10	107TA7815
1"7/8 UNS	I		18	57	47,63	25	15	10	107TA7816
2"1/8 UNF	I		12	62	53,98	25	15	10	107TA7817
2"1/8 UNEF	I		16	62	53,98	25	15	10	107TA7818
2"1/4 UNF	I		12	65	57,15	25	15	10	107TA7819
2"3/8 UNEF	I		16	72	60,32	25	15	10	107TA7820
2"1/2 UNF	I		12	72	63,5	25	15	10	107TA7821
2"1/2 UNEF	I		16	72	63,5	25	15	10	107TA7822
G1/8	G		28	14			9	5	134TA2337
G1/4	G		19	19			9	5	134TA2338
G3/8	G		19	21			10	6	134TA2339
G1/2	G		14	26			12	6	134TA2340
G5/8	G		14	28			12	6	134TA2341
G3/4	G		14	31,5			12	8	134TA2342
1/4 NPTF	I		18	19	6,35	12	7	5	107TA7789



TYPE C

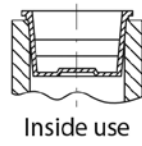

Inside use

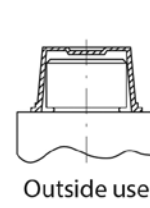
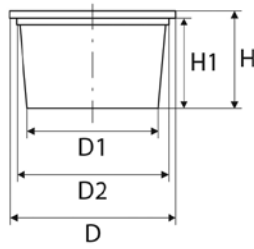

Outside use

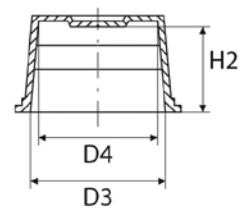

D (mm)	D1 (mm)	D2 (mm)	D3 (mm)	D4 (mm)	H1 (mm)	H2 (mm)	REF
10	4,4	6,15	4,55	2,8	10	10,8	107TA5721
11	6	7,75	6,15	4,4	10	10,8	107TA5722
11	8,1	9,2	7,8	6,6	7,2		134TA2641
11	9	7,4			9,5	10,5	134TA2427
12	8,3	6			16	17	134TA2425
12	8,9	5,8			9,5	10,5	134TA2426
12	9,8	11	9,6	8,4	7,2		134TA2642
13	7,2	5,2			9	10,5	134TA2424
13	7,6	9,35	7,75	6	10	10	107TA5723
14	8,4	10,15	8,55	6,8	10	10	107TA5724
14	9,2	10,95	9,25	7,5	10	10	107TA5725
14	10,6	11,6	10	8,8	7		134TA2643
15	9,9	11,65	10,05	8,3	10	10	107TA5726
15	11,4	12,4	11,2	10	7		134TA2644
15	12,8	11,3			9,5	10,5	134TA2432
16	10,3	8			15,5	16,5	134TA2428
16	10,6	12,35	10,75	9	10	10	107TA5727
16	10,8	8			15,8	17	134TA2429
16	13,3	14,4	12,8	10	7		134TA2645
17	11,3	13	11,2	9,5	11,3	10	107TA5728
17	14	151	136	124	72		134TA2646
17	14,7	11,7			9,5	10,5	134TA2434
18	12	14,1	12,5	10,4	12	12	107TA5729
18	12	9,8			10	11,2	134TA2430
18	12,5	14,6	13,3	11,2	12	12	107TA5730
18	13,4	11,5			10	10	134TA2433
18	14,6	15,6	14,5	13,3	7,2		134TA2647
18	15,3	16,4	14,8	13,6	7		134TA2648
19	13,5	15,6	14	11,9	12	12	107TA5731
19	14	16,1	14,5	12,4	12	12	107TA5732
20	14,5	11,5			20,8	21,1	134TA2435
20	15,2	12,8			12,7	13,7	134TA2436
20	16	17,3	16,2	14,6	9		134TA2649
20	17	14,5			24	25,5	134TA2440
20	17	14,5			9,5	10,5	134TA2439
21	14,7	17	15,5	13,2	13	13	107TA5733
21	17,4	18,8	18	16,4	9,2		134TA2650



TYPE C							
D (mm)	D1 (mm)	D2 (mm)	D3 (mm)	D4 (mm)	H1 (mm)	H2 (mm)	REF
21	18,4	15,5			25	26	134TA2441
22	16,3	18,6	17	14,7	13	13	107TA5734
22	16,6	13,5			21	22	134TA2437
22	17,1	19,4	17,8	15,5	13	13	107TA5735
22	18,2	19,6	18,8	17,2	9		134TA2651
22	20,7	17,7			9,5	10,5	134TA2446
24	16,6	13,5			9	10,5	134TA2438
24	17,5	20,1	18,5	15,9	15	15	107TA5736
24	18,7	20	19	17,7	9,2		134TA2652
24	19,8	21,2	19,7	18,3	8,8		134TA2653
25	18,4	21	19,4	16,8	15	15	107TA5737
25	18,9	16,5			10,5	11	134TA2443
25	19	21,6	20	17,4	15	15	152TA1947
25	20,3	22,6	20,8	18,4	14		134TA2654
25	22,5	19,7			12	12,5	134TA2447
26	212	233	22	196	142		134TA2655
26	246	215			25	26	134TA2450
27	20,4	23,2	21,6	18,8	16	16	107TA5739
28	18,4	15,5			25	26	134TA2442
28	20,2	17,8			21	21,5	134TA2445
28	20,7	23,5	21,9	19,1	16	16	107TA5740
28	23	25	24	21,6	14		134TA2656
28	23,9	20,3			29	29,5	134TA2448
28	25,5	22,3			17	18,5	134TA2451
29	22	24,8	23,2	20,4	16	16	107TA5741
30	23,2	26,35	24,35	21,2	18	18	107TA5742
30	24,3	26,4	25	22,6	14		134TA2657
30	25,7	27,8	26,8	24,4	14,2		134TA2658
31	27	24,8			20,5	21,8	134TA2452
32	24,5	21,2			10	10,5	134TA2449
32	24,5	27,8	26,2	22,9	19	19	107TA5743
32	27,2	29,3	27	24,6	14		134TA2659
32	28,4	26			9,5	10	134TA2453
33	25,2	29,2	27,1	23,7	19	19	107TA5744
33	26,4	30,4	28,9	24,9	19	19	107TA5745
33	30	27,3			19	20,5	134TA2454
34	31	28			9,5	10,5	134TA2455
35	27,8	31,1	29,5	26,2	19	19	107TA5746
35	30	32	30,6	28,4	14		134TA2660
36	32,5	29,6			21	22,5	134TA2456
37	29,8	32,6	31,1	28,3	16	16	107TA5747
37	32,8	29,4			19	20	134TA2457
38	31,4	35,1	33,4	29,7	21	21	107TA5748



TYPE C

D (mm)	D1 (mm)	D2 (mm)	D3 (mm)	D4 (mm)	H1 (mm)	H2 (mm)	REF
38	32	34	32	29,6	14		134TA2661
40	33,6	36	34	31,6	14		134TA2662
41	33,3	37,1	35,5	31,7	22	22	107TA5749
41	34,5	37	35	32,6	14		134TA2663
42	35,5	38,1	35,5	33,1	14		134TA2664
42	36	38,4	36	33,6	14		134TA2665
43	38,5	41	39,5	37,1	14		134TA2667
43	40,5	37,5			9,5	11	134TA2459
44	37,9	40	38	35,6	13,8		134TA2666
45	36,7	40,5	39	35,2	22	22	107TA5750
45	38,4	40,7	39,2	36,9	13	13	152TA1948
46	39,8	42	39,5	37,1	14		134TA2668
47	38,8	35,4			21	22	134TA2458
47	41,3	43,5	41,5	39,1	14		134TA2669
48	38,2	43	41,4	36,6	23	23	107TA5752
48	39,6	42,9	41,9	38	19	19	107TA5753
49	41,4	44,7	43	39,7	19	19	107TA5754
50	44,8	41,4			19	20	134TA2460
51	44,4	47,7	46,1	42,8	19	19	107TA5755
51,5	43,9	46	42	40,2	13,5		134TA2670
52	45,5	47,5	45	43	13,5		134TA2671
53,5	50,5	48,3			24	25,5	134TA2461
54	45,2	49,6	48	43,6	25	25	107TA5756
54	47,9	50	46,5	44,1			134TA2672
54,5	52	49			9,5	10,5	134TA2462
55	46,6	51	49,6	45,2	25	25	107TA5757
55	50,5	53,3	51,3	48,8	14		134TA2674
56	49,8	51,6	48,5	46,1	13,3		134TA2673
58	52,5	54,9	51,5	49,1	13,5		134TA2675
60	54,5	56,2	54	51,6	13,5		134TA2676
61	55,5	58	55	52,6	13,6		134TA2677
61	58	55			12,5	12,5	134TA2463
62	52,5	56,9	55,2	20,8	25	25	107TA5758
63	57	59	56,8	54,5			134TA2678
64	58,5	60,8	58	55,6	13,5		134TA2679
65	54	59,25	57,75	52,5	25	25	107TA5759
65	54,2	58,6	57	52,6	25	25	107TA5760
66	60,5	63	60	57,6	13,5		134TA2680
67	58,4	62,8	61,1	56,7	25	25	107TA5761
67	61,3	63,5	61	58,6	13		134TA2681
68	62,5	64,8	62	59,6	13,2		134TA2682
69	63,5	65,7	63	60,1	13		134TA2683
69	64	61,5			29	30,5	134TA2464



TYPE C							
D (mm)	D1 (mm)	D2 (mm)	D3 (mm)	D4 (mm)	H1 (mm)	H2 (mm)	REF
71	60,7	67,1	64,3	59	29	29	107TA5762
71	65	67,3	64,5	62,3	13		134TA2684
72	66	67,5	65	62,6	13		134TA2685
72	69,5	66,5			29	29,5	134TA2465
74	67,9	69,5	67	64,6	13		134TA2686
75	67,1	70,5	68,7	65,4	19	19	107TA5763
75	69,8	71,7	68	66	13		134TA2687
77	71,5	73,4	70	67,6	13		134TA2688
79	72,8	74	70	67,6	13		134TA2689
80	76	70			20	20,5	134TA2466
83	72,4	75,7	74,1	70,8	19	19	107TA5764
85	74	76,6	73	69,9	17		134TA2690
87	76,5	79	76,5	73,4	16,8		134TA2691
88	77,5	80	76	72,9	17		134TA2692
89	82	86	83,9	79,7	23		134TA2695
90	79	82	78	75,4	17		134TA2693
92	81,5	83,6	80	76,9	16,5		134TA2694
92	84,5	87,8	85,7	82,4	19	19	107TA5765
95	84	87,1	83	79,9	16,5		134TA2696
97	86,5	89	86	82,9	17,5		134TA2697
100	89	91,5	88	84,9	17		134TA2698
102	91,5	94	92	88,9	17		134TA2699
105	94	96	92	90	17		134TA2700
107	96,5	99	96	92,9	17		134TA2701
110	99	102,5	99	95,9	17		134TA2702
112	101,5	104	102	98,9	17		134TA2703
115	104	106,5	104	100,9	17		134TA2704
117	106,5	109	106	102,9	17		134TA2705
120	109	111	108	105	17		134TA2706
123	112	114,5	112,5	109,4	17		134TA2707
124,5	114,3	119,2	117,1	112,1	28		134TA2709
125	114	117	114,5	111,4	16,6		134TA2708
130	119	123	120,2	116,1	23		134TA2710
134	124	128	123	119,1	23		134TA2711
140	129	133	130,2	126,1	23		134TA2713
143	133	137	133	129	23		134TA2714
159	149	153	148	144,1	23		134TA2717
159,5	146,8	152,6	149,9	144	23		134TA2716
169	159	162	158	154	23		134TA2719
170	160	164	160	156	23		134TA2720
179	169	172	168	164	23		134TA2721
184	174	177	173	169	23		134TA2722
189	179	182	178	174	23		134TA2723



TYPE C

D (mm)	D1 (mm)	D2 (mm)	D3 (mm)	D4 (mm)	H1 (mm)	H2 (mm)	REF
192	181,5	184,5	180,5	176,5	23		<u>134TA2724</u>
199,5	183,6	190,6	187,9	182	33		<u>134TA2725</u>
209	199	202	198	194	22,5		<u>134TA2726</u>
212	202	205	202,1	198,1	23		<u>134TA2727</u>
213	203	205	202	199	23		<u>134TA2728</u>
216	206	210,6	206	201,6	23,5		<u>134TA2729</u>
235	218	222	217,4	213,5	22,5		<u>134TA2730</u>
242	225	229	225,4	221,3	23,5		<u>134TA2731</u>
249,5	231,2	238,2	235,6	228,6	33		<u>134TA2732</u>
265	253	258	253	249,2	18		<u>134TA2734</u>
267	249	252	248	244,1	22,5		<u>134TA2733</u>
314	293,4	300,2	296,7	289,8	32,5		<u>134TA2735</u>
315	299	304	298	294,1	22,5		<u>134TA2736</u>
326	308	313	308	303,4	21,8		<u>134TA2737</u>
329	311	316	311	306,4	22		<u>134TA2738</u>
358	338	343	338	333,4	22		<u>134TA2739</u>
399	371,9	381	377,7	368,4	32,5		<u>134TA2740</u>
415	398	406	399	392,7	30		<u>134TA2741</u>
455	435	443	437	430,7	30		<u>134TA2742</u>
499	365,4	476,7	472,8	461,3	32		<u>134TA2743</u>
506	484	491	486	479,7	30		<u>134TA2744</u>
1376	1275	1306	1276	1236	23		<u>134TA2712</u>
1636	1535	1575	1536	1496	23		<u>134TA2718</u>



TYPE D

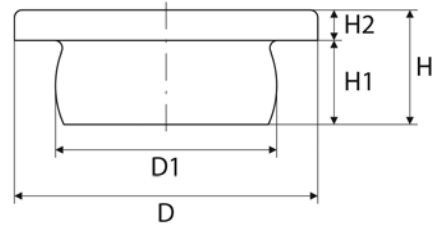

D (mm)	D1 (mm)	D2 (mm)	H (mm)	H1 (mm)	H2 (mm)	REF
5	3,1			2	3	134TA2347
5	6,6			2	3	163TA8520
13	6,2	3,8		6	7,3	134TA2575
13	6,4	5		9	10,8	134TA2576
13	7,1	4,7		6	7,8	134TA2577
13	7,8	6		9	10,8	134TA2579
13	8,2	5,8		6	7,8	134TA2578
13	8,8			7,5	9,5	134TA2354
13	9,3	7,7		6	7,3	134TA2580
13	10,3			5,5	7,5	134TA2357
14	10,7		7,5	5,5	2	107TA5808
14	10,7			5,5	7,5	134TA2358
14	7,2		8	6	2	107TA5803
14	7,2		8	6	2	134TA2350
14	8,4		8	6	2	107TA5804
14	8,4			6	8	134TA2351
14	8,6		6,5	4,5	2	107TA5805
14	8,6			4,5	6,5	134TA2352
14	9,2		6,5	4,5	2	107TA5806
14	9,2			4,5	6,5	134TA2355
14	9,4		6,5	4,5	2	107TA5807
14	9,4			4,5	6,5	134TA2356
16	10,4	8		11	12,8	134TA2582
16	10,4	8,1		8	9,2	134TA2581
16	10,7			7	9	134TA2359
16	10,8	8,8		8	9,8	134TA2583
16	11,3	9,4		8	9,3	134TA2584
16	11,7		9	7	2	107TA5809
16	11,9	9,7		13	14,5	134TA2585
16	11,9	9,7		8	9,2	134TA2586
16	12,3		9	7	2	107TA5810
16	12,3			7	9	134TA2360
16	13		9	7	2	107TA5811
16	13			7	9	134TA2361
18	8,6			6	8	134TA2353
19	12,9	10,9		8	9,8	134TA2587
19	13,7	11,7		8	9,8	134TA2588



TYPE D

D (mm)	D1 (mm)	D2 (mm)	H (mm)	H1 (mm)	H2 (mm)	REF
19	14	11,7		16	17,7	134TA2589
19	14,5	12,5		8	9,3	134TA2590
19	15	13		8	9,3	134TA2591
20	13,7		10	8	2	107TA5812
20	13,7		10	8	2	134TA2362
20	14,6		7,5	5,5	2	107TA5813
20	14,7		8	4	2	134TA2348
20	15		10	8	2	134TA2363
20	15		11,6	8	2	107TA5814
20	15		7,5	5,5	2	107TA5815
20	15			5,5	7,5	134TA2364
20	15,6		10	8	2	107TA5816
20	16,5			5,5	7,5	134TA2367
20	16,7		7,5	5,5	2	107ta8689
22	16,5		7,5	5,5	2	107TA5818
22	16,5			5,5	7,5	134TA2366
22	16,7		7,5	5,5	2	107TA5817
22	16,7			5,5	7,5	134TA2365
22	17,1		10,5	8	2,5	152TA1932
22	17,1		10,5	8	2,5	134TA2368
24	15,9	13,7		9	10,7	134TA2592
24	17	14,7		9	10,6	134TA2593
24	17,7	15,7		9	10,7	134TA2595
24	17,8	14,7		22	23,3	134TA2594
24	18,3	16,5		9	10,7	134TA2596
25	18,4		10,5	8	2,5	107TA5821
25	18,4		10,5	8	2,5	134TA2369
25	19,3		10,8	8	2,8	107TA5822
25	19,3			8	10,8	134TA2370
25	19,6		10,5	8	2,5	107TA5825
25	19,6			8	10,5	134TA2373
25	20,7		10,5	8	2,5	107TA5827
25	20,7			8	10,5	134TA2375
25	21,2		9,5	7,5	2	107TA5823
25	21,2			8	10	134TA2374
25	21,4			7,5	9,5	134TA2371
25	21,5		10	8	2	107TA5826
25	21,7		10,5	8	2,5	107TA5824
25	21,7		10,5	8	2,5	134TA2372
26	19,9	17,7		10	12,2	134TA2597
26	20,9	18,7		10	12,2	134TA2598
26	21,5	18,7		26	28,2	134TA2599
26	22	19,7		10	12,2	134TA2600



TYPE D

D (mm)	D1 (mm)	D2 (mm)	H (mm)	H1 (mm)	H2 (mm)	REF
26	22,7	20,5		10	12,2	134TA2601
27	24,5		11	8,5	2,5	107TA5832
27	24,5			8,5	11	134TA2380
28	22,4		12	9	3	107TA5828
28	22,4			9	12	134TA2376
28	23,6		12	9	3	107TA5829
28	23,6		12	9	3	134TA2377
28	24		12	9	3	107TA5830
28	24			9	12	134TA2378
28	24,6		12	9	3	107TA5831
28	24,6			9	12	134TA2379
28	25,5		9,5	7,5	2	107TA5833
28	25,5			7,5	9,5	134TA2381
28	26,5		12	9	3	107TA5834
28	26,5		12	9	3	134TA2382
29	23,2	21,2		10	12,2	134TA2602
29	23,7	21,7		10	12,2	134TA2603
29	24,4	23		10	12,2	134TA2604
29	25	23,7		10	12,2	134TA2605
33	26,3	24,9		11	13,2	134TA2606
33	27,2	25,2		11	13,2	134TA2607
33	28,3	25,7		11	13,2	134TA2608
33	29,3	26,9		11	12,5	134TA2609
36	29		15	12	3	107TA5835
36	29			12	15	134TA2383
36	30,1	27,9		11	12,6	134TA2610
36	30,4	28,3		11	13,2	134TA2611
36	30,5		15	12	3	107TA5836
36	30,5			12	15	134TA2384
36	31			12	15	134TA2385
36	31,8		12,5	12	,5	107TA5837
36	32	29,7		11	12,5	134TA2612
36	32			10	12,5	134TA2386
36	32,8	30,5		11	13,2	134TA2613
36	33,5		14	12	2	107TA5838
36	33,5			12	14	134TA2387
42	33,9	31,5		12	14,2	134TA2614
42	34,5	32,5		11	13,2	134TA2615
42	34,8		18	15	3	107TA5839
42	34,8			15	18	134TA2388
42	35,3	32,4		12	14,2	134TA2616
42	35,5		18	15	3	107TA5840
42	35,5		18	15	3	134TA2389



TYPE D

D (mm)	D1 (mm)	D2 (mm)	H (mm)	H1 (mm)	H2 (mm)	REF
42	36,5	34,7		12	14,2	134TA2617
42	36,5		18	15	3	107TA5841
42	36,5			15	18	134TA2390
42	38,4		12,5	10	2,5	107TA5842
42	38,4			10	12,5	134TA2391
42	39		18	15	3	107TA5843
42	39			15	18	134TA2392
42	40		18	15	3	107TA5844
42	40			15	18	134TA2393
45	38	35,7		12	14,2	134TA2618
45	38,9	36,7		12	14,2	134TA2619
45	39,4	37,5		12	14,2	134TA2620
45	40,2	38,5		12	14,2	134TA2621
45	40,7		18	15	3	107TA5845
45	40,7			15	18	134TA2394
48	42,3		18	15	3	107TA5846
48	42,3			15	18	134TA2395
50	41,8	39,5		12	13,7	134TA2622
50	43,7	41,5		12	14,2	134TA2623
50	44,8	42		12	14,2	134TA2624
55	46		21	18	3	107TA5847
55	48,3	46,3		12	14,2	134TA2626
55	48,5		15	12	3	107TA5848
55	48,5			12	15	134TA2396
55	51,5		21	18	3	107TA5849
55	51,5			18	21	134TA2397
56	46,8	44,5		12	13,7	134TA2625
56	48,7	46,7		12	14,2	134TA2627
56	50,5	47,5		20	22,2	134TA2628
62	54	51,5		13	14,2	134TA2629
63	55		21	18	3	107TA5850
63	55			18	21	134TA2398
63	55,8		21	18	3	107TA5851
63	55,8			18	21	134TA2399
63	58		21	18	3	107TA5852
63	58			18	21	134TA2400
63	59			18	21,3	134TA2402
65	60,8	58		18	18	134TA2630
71	66		21,5	18	3,5	107TA5853
71	66			18	21,5	134TA2401
72	62,5	59,2		14	16	134TA2631
78	71		22	18	4	107TA5854
78	71			18	22	134TA2403



TYPE D

D (mm)	D1 (mm)	D2 (mm)	H (mm)	H1 (mm)	H2 (mm)	REF
85	79,5	76,5		18	18	<u>134TA2632</u>
86	75,8			19	22	<u>134TA2404</u>
88	75,6	72,9		14	16,5	<u>134TA2633</u>
92	88,5	85		20	20	<u>134TA2634</u>
95	86			18	19,3	<u>134TA2405</u>
124	102,5			18	21,5	<u>134TA2406</u>
152	123,5			18	21,5	<u>134TA2407</u>
165	152			17,5	20	<u>134TA2408</u>
200	182			19,5	22	<u>134TA2409</u>



TYPE E1

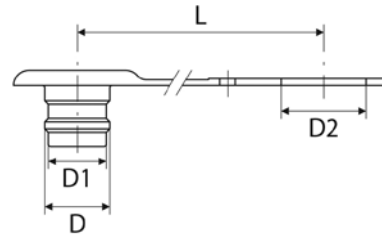

Thread	Pitch	D (mm)	D1 (mm)	D2 (mm)	L (mm)	REF
1/4		12	11	22	125	107TA5796
3/8		18	16	22	125	107TA5797
1/2		24	20	29	135	107TA4296
1/2		24	20	27	135	107TA5798
M36	2	36	29	30	135	152TA1949

TYPE E2

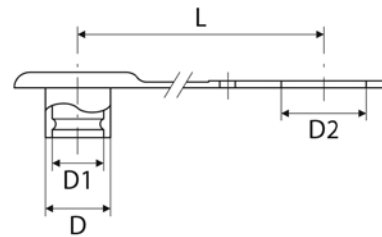

Thread	D (mm)	D1 (mm)	D2 (mm)	L (mm)	REF
1/4	12,5	11,5	22	125	107TA5799
3/8	18,5	16	22	125	107TA5800
1/2	24	23	27	135	107TA4294
1/2	24	23	29	135	107TA5801



TYPE F

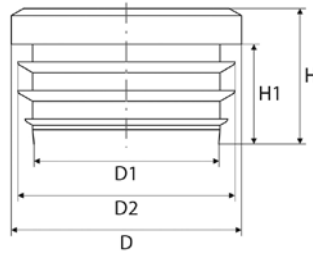

D (mm)	D1 (mm)	D2 (mm)	H (mm)	H1 (mm)	H2 (mm)	REF
10	5	8,5	15	11		134TA2494
12	7	10,5	15	11		152TA1934
13	8	11,5	15	11		134TA2496
14	9	12,5	15	11		152TA1935
15	10	13,5	15	11		134TA2498
16	11	14,5	15	11		134TA2499
16	12,3			3	2	134TA2467
18	13	16,5	15	11		134TA2500
18	15,4			4	1	134TA2468
20	15	18,5	15	11		152TA1936
20	17,6			4	2	134TA2469
22	16	20,5		14	19	134TA2502
25	19	23,5	19	14		134TA2503
25	21,1			2,5	1,5	134TA2471
27	21	25,5	19	14		134TA2504
28	22	26,5	19	14		152TA1937
28	26			4	2,2	134TA2472
30	24	28,5	19	14		152TA1938
32	26	30,5	19	14		134TA2507
34	28	32,5	19	14		134TA2508
35	20,5			5	2,5	134TA2470
35	29	33,5	19	14		152TA1939
36	30	34,5	19	14		134TA2510
36	33,5			4	2	134TA2476
38	26			5,3	2,1	134TA2473
38	27			4,3	2	134TA2475
38	27			7,5	2	134TA2474
38	32	36,5	19	14		152TA1940
40	34	38,5	19	14		134TA2512
42	36	40,5	19	14		152TA1941
45	39	43,5	19	14		134TA2514
48	42	46,5	22	17		134TA2515
50	40			4	2	134TA2478
50	40,4			2,4	1,8	134TA2479
50	43	48,5	22	17		134TA2516
53	36,5			5	2	134TA2477
55	48	53,5	22	17		134TA2517



TYPE F

D (mm)	D1 (mm)	D2 (mm)	H (mm)	H1 (mm)	H2 (mm)	REF
55	50,6			4	2	<u>134TA2480</u>
60	51	56,5	22	17		<u>134TA2519</u>
60	53	58,5	22	17		<u>134TA2518</u>
62	53,8			4	2	<u>134TA2481</u>
66	61,5			7,8	2	<u>134TA2482</u>
68	62			4	1,8	<u>134TA2483</u>
70	59	64,5	22	17		<u>134TA2521</u>
70	61	66,5	22	17		<u>134TA2520</u>
76	65	70,5	22	17		<u>134TA2523</u>
76	67	72,5	22	17		<u>134TA2522</u>
76	71,5			5	2,5	<u>134TA2485</u>
83	75			8	2	<u>134TA2487</u>
85	64,6			4,1	2	<u>134TA2484</u>
90	72,8			7,5	2	<u>134TA2486</u>
90	79	84,5	22	17		<u>134TA2525</u>
90	81	86,5	22	17		<u>134TA2524</u>
90	82			8	2	<u>134TA2488</u>
102	91	96,5	22	17		<u>134TA2527</u>
102	93	98,5	22	17		<u>134TA2526</u>
103	93			7,7	2	<u>134TA2489</u>
109	101			5	2	<u>134TA2490</u>



TYPE G

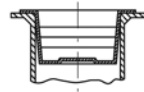

Inside use

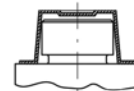
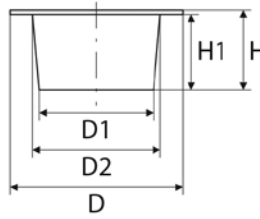

Outside use

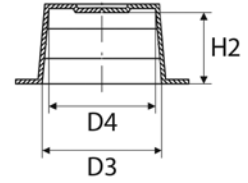

D (mm)	D1 (mm)	D2 (mm)	D3 (mm)	D4 (mm)	H1 (mm)	H2 (mm)	REF
22	4,4	6,3	4,6	2,7	11	11,2	134TA2745
23	6	7,9	6,1	4,3	11	11,2	134TA2746
25	7,6	9,5	7,8	5,9	11	11	152TA1956
26	8,4	10,3	8,6	6,8	11	10	134TA2748
27	9,9	11,7	10	8,3	11	10	134TA2750
28	10,6	12,4	10,6	8,8	11	10	134TA2751
29	11,3	13,2	11,6	9,8	11	10	134TA2752
30	12	14,2	12,5	10,4	13	12	134TA2753
30	12,5	14,6	13,1	11,2	13	12	134TA2754
31	13,8	15,9	14,1	12	13	12	134TA2755
31	14	16,4	14,5	12,2	13	12	134TA2756
33	15	17,2	15,5	13,4	14	13	134TA2757
34	16,5	18,8	17,1	14,8	14	13	134TA2758
34	17,4	19,6	17,8	15,6	14	13	134TA2759
36	17,7	20,3	18,6	16	16	15	134TA2760
37	18,6	21,2	19,5	16,9	16	15	134TA2761
37	19,3	21,9	20,1	17,6	16	15	134TA2762
39	20,8	23,5	21,8	18,9	17	16	134TA2763
40	21,2	24	22,1	19,3	17	16	134TA2764
41	22,3	25,2	23,4	20,4	17	16	134TA2765
42	23,7	27	24,1	20,9	19	18	134TA2766
44	25	28,3	26,4	23	20	19	134TA2767
45	26,4	29,5	27,7	24,7	20	19	134TA2768
47	28,3	31,4	29,7	26,4	20	19	134TA2769
49	29,8	32,9	31,2	28,1	20	19	134TA2770
50	32	35,5	33,6	29,8	22	21	134TA2771
52	33,8	37,8	36	31,9	23	22	134TA2772
54	36,4	40,2	38,4	34,5	22	21	134TA2773
60	39,2	43,1	41,3	37,2	23	22	134TA2774
64	44,4	44,4	46,1	42,6	20	18	134TA2776
66	50,5	50,5	51,1	48,8	14	13,7	134TA2777
70	41,3	44,8	43	39,5	20	19	134TA2775
74,3	52,7	52,7	54,6	51	25	24,7	134TA2778
85	62,5	62,5	66	60,4	20,5	20,5	134TA2779



TYPE H

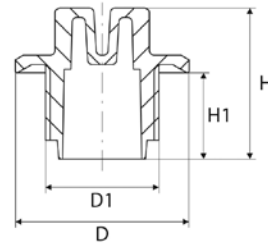

Thread	Metric/inch	Imperial pitch	Pitch	D (mm)	D1 (mm)	H (mm)	H1 (mm)	REF
M8	M	1		12,2	8	15	8	134TA2797
M10	M	1		14,2	10	15	8	134TA2798
M12	M	1,5		17,2	12	18	11	134TA2799
M14	M	1,5		19,2	14	19	11	134TA2800
M16	M	1,5		22	16	21	11	134TA2801
M18	M	1,5		24	18	21	11	134TA2802
M20	M	1,5		26	20	21	11	134TA2803
M22	M	1,5		27,2	22	21	11	134TA2804
M26	M	1,5		32	26	23,5	13,5	134TA2805
M27	M	2		32,3	27	21	11	152TA1960
M33	M	2		40,4	33	23,5	13,5	134TA2807
M42	M	2		50	42	23,5	13,5	134TA2808
M48	M	2		55,4	48	23,5	13,5	134TA2809
M60	M	2		68,5	60	23,5	13,5	134TA2810
9/16 UNF	I		18	17,8	14,29	18	11	134TA2818
G1/4	I		19	19,2	13,16	15,5	7,5	134TA2811
G3/8	I		19	22,2	16,66	17,5	7,5	134TA2812
G1/2	I		14	27,2	20,96	19,5	9,5	134TA2813
G3/4	I		14	32,2	26,44	19,5	9,5	134TA2814
G1	I		11	40,4	33,25	21,5	11,5	134TA2815
G1 1/4	I		11	50,4	47,91	22,5	11,5	134TA2816
G1 1/2	I		11	55,4	47,81	22,5	11,5	134TA2817



TYPE I

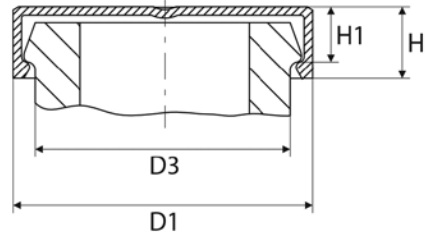

D1 (mm)	D3 (mm)	H1 (mm)	REF
30,2	29,4	6,9	134TA2780
31,7	30,9	7,9	134TA2781
38,1	37,3	6,9	134TA2782
41,3	40,5	8,9	134TA2783
44,4	43,6	8,1	134TA2784
47,6	46,8	9,7	134TA2785
50,5	49,5	8,1	134TA2786
54	53,2	10,4	134TA2787
60,3	59,5	8,1	134TA2788
62,5	63,5	12,7	134TA2789
71,4	70,6	9,7	134TA2790
79,4	78,6	12,7	134TA2791
90,3	88,3	9	134TA2792
106	104	10	134TA2793
125	123	11	134TA2794
150	148	12	134TA2795
213	211	16	134TA2796



21

GEAR COUPLING



TECHNICAL DETAIL: GEAR COUPLING

Group
03-04-01-02

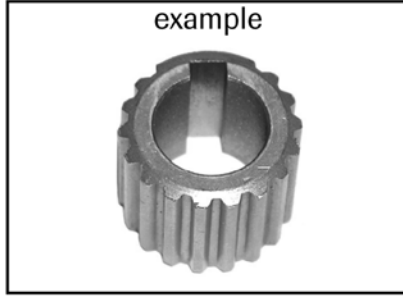

customer details:

Type machine: Price inquiry
 Serial no. machine: Order

CODE: TY x D1 x D2 x H x B1 x B2 x AC1 x AC2

- | | |
|-------|---|
| . | TY type of gear , see diagrams |
| .,.,. | D1 dimension, see diagrams |
| .,.,. | D2 dimensions,see diagrams |
| .,.,. | H total height |
| .,.,. | B1 dimension, see diagrams |
| .,.,. | B2 dimension, see diagrams |
| .. | AC1 number of splines, see diagrams |
| .. | AC2 number of splines, see diagrams |



TECHNICAL DETAIL: GEAR COUPLING

Type A

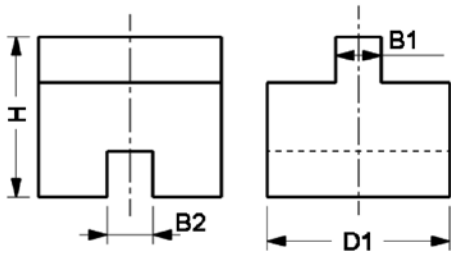

Type B

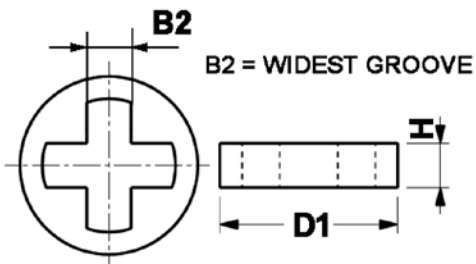

Type C

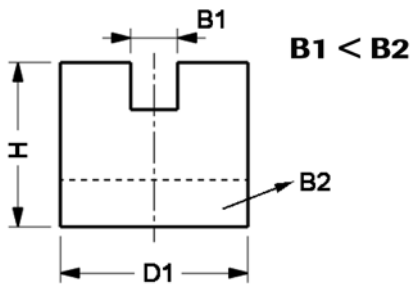

Type D

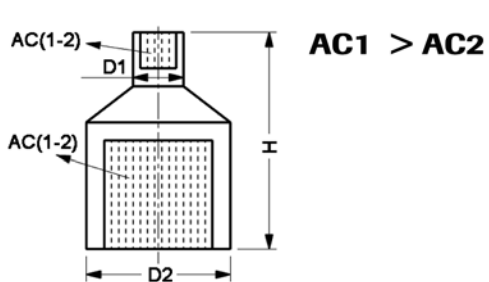

Type E

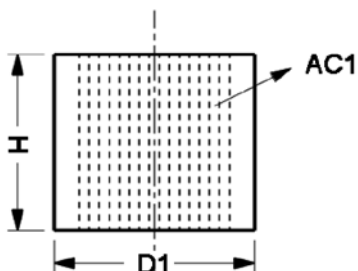



TECHNICAL DETAIL: GEAR COUPLING

Type F

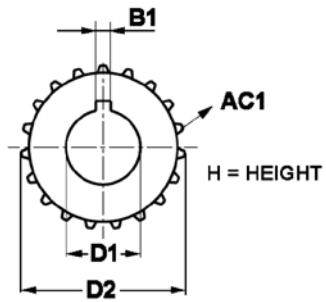

Type G

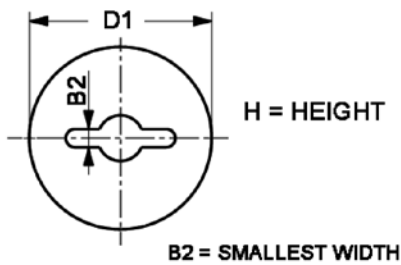

Type H

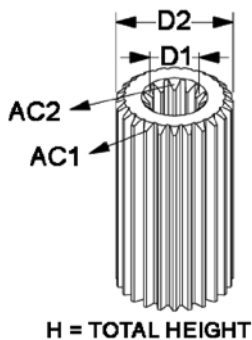

Type S

Special - none of the previous types

- D1 = max. inner \emptyset or dimension
- D2 = max. outer \emptyset or dimension
- H = total height
- B1 = inner width groove
- B2 = outer thickness pin
- AC1 = smallest number of splines
- AC2 = smallest number of splines





TECHNICAL DETAIL: GEAR COUPLING

Groep
03-04-01-02



Gegevens klant

Type machine:

Prijsaanvraag

Serienr. machine:

Bestelling

CODE: TY x D1 x D2 x H x B1 x B2 x AC1 x AC2



- TY..... Type meenemer, zie figuren.
- D1 Afmeting, zie figuren.
- D2 Afmeting, zie figuren.
- H..... Totale hoogte.
- B1..... Afmeting, zie figuren.
- B2..... Afmeting, zie figuren.
- AC1 Aantal kanaluren, zie figuren.
- AC2 Aantal kanaluren, zie figuren.

zie Engelse technische fiche !



TECHNICAL DETAIL: GEAR COUPLING

Groupe
03-04-01-02

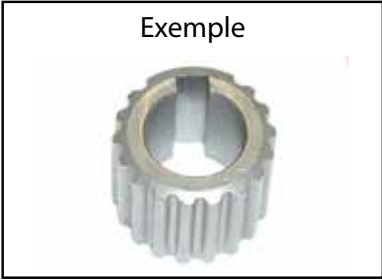

Données client

Type machine :

Demande de prix

No. série machine :

Commande

CODE : TY x D1 x D2 x H x B1 x B2 x AC1 x AC2



- TY..... Type d'accouplement, voir figures.
- D1 Dimension, voir figures.
- D2 Dimension, voir figures.
- H..... Hauteur totale.
- B1..... Dimension, voir figures.
- B2..... Dimension, voir figures.
- AC1 Nombre de cannelures, voir figures.
- AC2 Nombre de cannelures, voir figures.

voir la fiche technique en Anglais.



TECHNICAL DETAIL: GEAR COUPLING

Gruppe
03-04-01-02



Kundendaten

Maschinentyp:

Preis Anfrage

Serien-Nr. Maschine:

Bestellung

CODE: TY x D1 x D2 x H x B1 x B2 x AC1 x AC2



- TY..... Mitnehmertyp, siehe Figuren.
- D1 Maß, siehe Figuren.
- D2 Maß, siehe Figuren.
- H..... Gesamthöhe.
- B1..... Maß, siehe Figuren.
- B2..... Maß, siehe Figuren.
- AC1 Zahl der Einsparung, siehe Figuren.
- AC2 Zahl der Einsparung, siehe Figuren.

Siehe technische Datenblätter auf Englisch.



ENGAGING GEAR / COUPLING



REF 151TA2957

- Inner diameter (mm): 79
- Outer diameter (mm): 241
- Height (mm): 20,5
- Number of splines: 50

ENGAGING GEAR / COUPLING



REF 151TA2958

- Inner diameter (mm): 79
- Outer diameter (mm): 338
- Height (mm): 43
- Number of splines: 50

ENGAGING GEAR / COUPLING



REF 151TA2959

- Inner diameter (mm): 79
- Outer diameter (mm): 334
- Height (mm): 44
- Number of splines: 50

ENGAGING GEAR / COUPLING



REF 151TA2960

- Inner diameter (mm): 78
- Outer diameter (mm): 314
- Height (mm): 21
- Number of splines: 50

ENGAGING GEAR / COUPLING



REF 151TA2961

- Inner diameter (mm): 78
- Outer diameter (mm): 263,5
- Height (mm): 20
- Number of splines: 50

ENGAGING GEAR / COUPLING



REF 151TA2962

- Inner diameter (mm): 78,5
- Outer diameter (mm): 215,9
- Height (mm): 20
- Number of splines: 50



ENGAGING GEAR / COUPLING



REF 151TA2963

- Inner diameter (mm): 73
- Outer diameter (mm): 165
- Height (mm): 20
- Number of splines: 50

ENGAGING GEAR / COUPLING



REF 151TA2964

- Inner diameter (mm): 78
- Outer diameter (mm): 150,4
- Height (mm): 25
- Width (mm): 20
- Number of splines: 50

ENGAGING GEAR / COUPLING



REF 151TA2965

- Inner diameter (mm): 79
- Outer diameter (mm): 135
- Height (mm): 17
- Number of splines: 50

ENGAGING GEAR / COUPLING



REF 151TA2966

- Inner diameter (mm): 72,5
- Outer diameter (mm): 125
- Height (mm): 30
- Width (mm): 30
- Number of teeth: 50

ENGAGING GEAR / COUPLING



REF 151TA2967

- Inner diameter (mm): 110
- Outer diameter (mm): 263,5
- Height (mm): 28
- Number of splines: 42

ENGAGING GEAR / COUPLING



REF 151TA2968

- Inner diameter (mm): 100,8
- Outer diameter (mm): 314,5
- Height (mm): 26,8
- Number of splines: 42



ENGAGING GEAR / COUPLING

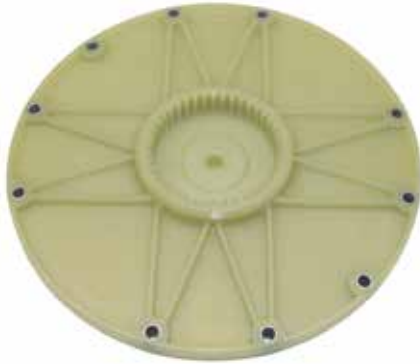

REF [151TA2969](#)

- Inner diameter (mm): 111
- Outer diameter (mm): 338
- Height (mm): 40
- Number of splines: 42



22

REELS



TOTALSOURCE® REEL WITH TWIN HOSE

Type	Reel diameter	Max hose length	Hose type	REF
1 Complete kit				
RH*	275 mm	4 m	Double synflex 1/4"	123TA7174
LH**	275 mm	4 m	Double synflex 1/4"	123TA7175

- 2 [REF 123TA7170](#) – RH reel (without hoses)*
- [REF 123TA7171](#) – LH reel (without hoses)**
- 3 [REF 123TA7172](#) – Hose, end connection 7/16" JIC/**
- [REF 135TA9665](#) – Hose, end connection 9/16" JIC/**
- 4 [REF 126TA5178](#) – Fitting*/** (2 required)
- 5 [REF 123TA7173](#) – Mounting bracket*/**

[REF 135TA9666](#) – Seal kit

[REF 135TA9667](#) – Spring assembly

- Max lifting height: 6 m (duplex mast), 5 m (triplex mast)
- Max working pressure: 200 bar, fluid flow: 30 l/min
- Hose reel supplied without inlet fittings, inside thread: 3/8" BSP

* Kit included for RH, ** Kit included for LH



TOTALSOURCE®

TOTALSOURCE® REEL WITH TWIN HOSE

Type	Reel diameter	Max hose length	Hose type	REF
1 Complete kit				
RH*	325 mm	4,5 m	Double synflex 3/8"	123TA7180
LH**	325 mm	4,5 m	Double synflex 3/8"	123TA7181

- 2 [REF 123TA7176](#) – RH reel (without hoses)*
- [REF 123TA7177](#) – LH reel (without hoses)**
- 3 [REF 123TA7178](#) – Hose, end connection 9/16" JIC/**
- 4 [REF 124TA3655](#) – Fitting*/** (2 required)
- 5 [REF 123TA7179](#) – Mounting bracket*/**

[REF 135TA9666](#) – Seal kit

[REF 135TA9705](#) – Spring assembly

- Max lifting height: 7 m (duplex mast), 6 m (triplex mast)
- Max working pressure: 180 bar, fluid flow: 30 l/min
- Hose reel supplied without inlet fittings, inside thread: 3/8" BSP

* Kit included for RH, ** Kit included for LH



TOTALSOURCE®

TOTALSOURCE® REEL WITH TWIN HOSE

Type	Reel diameter	Max hose length	Hose type	REF
1 Complete kit				
RH*	325 mm	5 m	Double synflex 5/16"	135TA9706
LH**	325 mm	5 m	Double synflex 5/16"	135TA9707

- 2 [REF 123TA7176](#) – RH reel (without hoses)*
- [REF 123TA7177](#) – LH reel (without hoses)**
- 3 [REF 135TA9708](#) – Hose, end connection 9/16" JIC/**
- 4 [REF 124TA3655](#) – Fitting*/** (2 required)
- 5 [REF 123TA7179](#) – Mounting bracket*/**

[REF 135TA9666](#) – Seal kit

[REF 135TA9705](#) – Spring assembly

- Max lifting height: 7 m (duplex mast), 6 m (triplex mast)
- Max working pressure: 180 bar, fluid flow: 30 l/min
- Hose reel supplied without inlet fittings, inside thread: 3/8" BSP

* Kit included for RH, ** Kit included for LH



TOTALSOURCE®



TOTALSOURCE® REEL WITH TWIN HOSE

Type	Reel diameter	Max hose length	Hose type	REF
1 Complete kit				
RH*	420 mm	6,7 m	Double synflex 3/8"	123TA7185
LH**	420 mm	6,7 m	Double synflex 3/8"	123TA7186

- 2 [REF 123TA7182](#) – RH reel (without hoses)*
- [REF 123TA7183](#) – LH reel (without hoses)**
- 3 [REF 123TA7184](#) – Hose, end connection 9/16" JIC*/**
- 4 [REF 124TA3655](#) – Fitting*/** (2 required)
- 5 [REF 123TA7179](#) – Mounting bracket*/**

[REF 135TA9709](#) – Seal kit

- Max lifting height: 11,5 m (duplex mast), 9,5 m (triplex mast)
- Max working pressure: 180 bar, fluid flow: 30 l/min
- Hose reel supplied without inlet fittings, inside thread: 3/8" BSP
- * Kit included for RH, ** Kit included for LH



TOTALSOURCE®

TOTALSOURCE® REEL WITH TWIN HOSE

Type	Reel diameter	Max hose length	Hose type	REF
1 Complete kit				
RH*	420 mm	4,7 m	Double synflex 1/2"	123TA7191
LH**	420 mm	4,7 m	Double synflex 1/2"	123TA7192

- 2 [REF 123TA7187](#) – RH reel (without hoses)*
- [REF 123TA7188](#) – LH reel (without hoses)**
- 3 [REF 123TA7189](#) – Hose, end connection 3/4" JIC*/**
- 4 [REF 124TA3657](#) – Fitting*/** (2 required)
- 5 [REF 123TA7190](#) – Mounting bracket*/**

[REF 135TA9709](#) – Seal kit

[REF 135TA9710](#) – Spring assembly

- Max lifting height: 9 m (duplex mast), 7,5 m (triplex mast)
- Max working pressure: 180 bar, fluid flow: 40 l/min
- Hose reel supplied without inlet fittings, inside thread: 3/8" BSP
- * Kit included for RH, ** Kit included for LH



TOTALSOURCE®

TOTALSOURCE® REEL WITH 2X TWIN HOSE

Type	Reel diameter	Max hose length	Hose type	REF
1 Complete kit				
RH*	370 mm	4,5 m	Double synflex 3/8"	123TA7197
LH**	370 mm	4,5 m	Double synflex 3/8"	123TA7198

- 2 [REF 123TA7193](#) – RH reel (without hoses)*
- [REF 123TA7194](#) – LH reel (without hoses)**
- 3 [REF 123TA7195](#) – Hose (2 required), end connection 9/16" JIC*/**
- 4 [REF 124TA3655](#) – Fitting*/** (4 required)
- 5 [REF 123TA7196](#) – Mounting bracket*/**

[REF 135TA9711](#) – Seal kit

[REF 135TA9712](#) – Spring assembly

- Max lifting height: 9 m (duplex mast), 7,5 m (triplex mast)
- Max working pressure: 180 bar, fluid flow: 30 l/min
- Hose reel supplied without inlet fittings, inside thread: 3/8" BSP
- * Kit included for RH, ** Kit included for LH



TOTALSOURCE®



TOTALSOURCE® CABLE HOSE REEL 2 PORT + CABLE

Type	Reel diameter	Max hose length	Hose type	REF
Complete kit				
RH	370 mm	4,6 m	Double synflex 3/8" + cable conductors 1,5 mm	136TA3224
LH	370 mm	4,6 m	Double synflex 3/8" + cable conductors 1,5 mm	140TA9151



- JIC fittings 9/16"
- Max lifting height: 9 m (duplex mast), 7,5 m (triplex mast)
- Max working pressure 180 bar, fluid flow 30 l/min
- Hose reel supplied without inlet fittings, inside thread 3/8 bsp

TOTALSOURCE®

TOTALSOURCE® 4 PORT HOSE REEL

Type	Reel diameter	Max hose length	Hose type	REF
Complete kit				
RH	325 mm	3,7 m	4 hoses synflex 1/4"	140TA9083
LH	325 mm	3,7 m	4 hoses synflex 1/4"	140TA9152



- Max working pressure 300 bar, fluid flow 30 l/min
- Hose reel supplied without inlet fittings, inside thread 3/8 bsp

TOTALSOURCE®

TECREEL REEL

Type	Reel diameter	Max hose length	Hose type	REF
1 Complete kit				
RH*	318 mm	3,5 m	Double synflex 5/16"	107TA3712
LH**	318 mm	3,5 m	Double synflex 5/16"	107TA3713

1



2



3



4



- 2 **REF 107TA3709** – RH reel (without hoses)*
REF 107TA3710 – LH reel (without hoses)**
 - 3 **REF 107TA3711** – Hose, end connection 9/16" JIC*/**
 - 4 **REF 107TA3705** – Fitting*/** (3/8" BSP, 2 required)
- * Kit included for RH, ** Kit included for LH

TECREEL REEL

Type	Reel diameter	Max hose length	Hose type	REF
1 Complete kit				
RH*	380 mm	5,6 m	Double synflex 5/16"	107TA3707
LH**	380 mm	5,6 m	Double synflex 5/16"	107TA3708

1



2



3



4



- 2 **REF 107TA3703** – RH reel (without hoses)*
REF 107TA3704 – LH reel (without hoses)**
 - 3 **REF 107TA8685** – Hose, end connection 9/16" JIC*/**
 - 4 **REF 107TA3705** – Fitting*/** (3/8" BSP, 2 required)
- * Kit included for RH, ** Kit included for LH



CASCADE REEL

Type	Reel diameter	Max hose length	Hose type	REF
1 Complete kit				
RH*	280 mm	3,91 m	Double synflex 1/4"	107TA3683
LH**	280 mm	3,91 m	Double synflex 1/4"	107TA3684

- 2 [REF 107TA3678](#) – RH reel (without hoses)*
 - [REF 107TA3679](#) – LH reel (without hoses)**
 - 3 [REF 107TA3681](#) – Hose, end connection 7/16" JIC*/**
 - 4 [REF 107TA3680](#) – Fitting*/** (4 required)
 - 5 [REF 107TA3682](#) – Mounting bracket*/**
- Max lifting height: 6,3 m (duplex mast), 4,8 m (triplex mast)
 * Kit included for RH, ** Kit included for LH



CASCADE REEL

Type	Reel diameter	Max hose length	Hose type	REF
1 Complete kit				
RH*	330 mm	4,57 m	Double synflex 3/8"	107TA3676
LH**	330 mm	4,57 m	Double synflex 3/8"	107TA3677

- 2 [REF 107TA3673](#) – RH reel (without hoses)*
 - [REF 107TA3674](#) – LH reel (without hoses)**
 - 3 [REF 107TA3675](#) – Hose, end connection 9/16" JIC*/**
 - 4 [REF 107TA3668](#) – Fitting*/** (4 required)
 - 5 [REF 107TA3670](#) – Mounting bracket*/**
- Max lifting height: 7,1 m (duplex mast), 5,5 m (triplex mast)
 * Kit included for RH, ** Kit included for LH



CASCADE REEL

Type	Reel diameter	Max hose length	Hose type	REF
1 Complete kit				
RH*	410 mm	7,62 m	Double synflex 3/8"	107TA3671
LH**	410 mm	7,62 m	Double synflex 3/8"	107TA3672

- 2 [REF 107TA3666](#) – RH reel (without hoses)*
 - [REF 107TA3667](#) – LH reel (without hoses)**
 - 3 [REF 107TA3669](#) – Hose, end connection 9/16" JIC*/**
 - 4 [REF 107TA3668](#) – Fitting*/** (4 required)
 - 5 [REF 107TA3670](#) – Mounting bracket*/**
- Max lifting height: 13 m (duplex mast), 9,81 m (triplex mast)
 * Kit included for RH, ** Kit included for LH



CASCADE REEL

Type	Reel diameter	Max hose length	Hose type	REF
1 Complete kit				
RH*	410 mm	5,79 m	Double synflex 1/2"	113TA1679
LH**	410 mm	5,79 m	Double synflex 1/2"	113TA1680

- 2 [REF 113TA1674](#) – RH reel (without hoses)*
 - [REF 113TA1675](#) – LH reel (without hoses)**
 - 3 [REF 113TA1677](#) – Hose, end connection 3/4" JIC*/**
 - 4 [REF 113TA1676](#) – Fitting*/** (4 required)
 - 5 [REF 107TA3734](#) – Mounting bracket*/**
- Max lifting height: 8,9 m (duplex mast), 7,4 m (triplex mast)
 * Kit included for RH, ** Kit included for LH





TECALEMIT REEL

Type	Reel diameter	Max hose length	Hose type	REF
1 Complete kit				
RH*	280 mm	3,3 m	Double synflex 1/4"	107TA3700
RH**	280 mm	3 m	Double synflex 5/16"	107TA8684
LH***	280 mm	3,3 m	Double synflex 1/4"	107TA3701
LH****	280 mm	3 m	Double synflex 5/16"	107TA3702



- 2 REF [107TA3696](#) – RH reel (without hoses)**
- REF [107TA3697](#) – LH reel (without hoses)****
- 3 REF [107TA3698](#) – Hose, 3,3 m, end connection 1/4" JIC*/***
- REF [107TA3699](#) – Hose, 3 m, end connection 5/16" JIC**/****
- 4 REF [107TA3688](#) – Fitting*/**/****/***** (2 required)
- REF [107TA3689](#) – Fitting*/**/****/***** (4 required)
- 5 REF [107TA3685](#) – Swivel*/**/****/*****

*/** Kit included for RH, ***/**** Kit included for LH

5

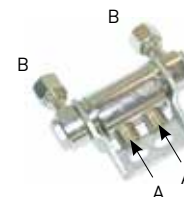

A Inlet adaptor pipe 10L, thread: M16 x 1,5
B Outlet adaptor pipe 10S, thread: M18 x 1,5

TECALEMIT REEL

Type	Reel diameter	Max hose length	Hose type	REF
1 Complete kit				
RH*	340 mm	6 m	Double synflex 1/4"	107TA3692
RH**	340 mm	5 m	Double synflex 5/16"	107TA3693
LH***	340 mm	6 m	Double synflex 1/4"	107TA3694
LH****	340 mm	5 m	Double synflex 5/16"	107TA3695



- 2 REF [107TA9686](#) – RH reel (without hoses)**
- REF [107TA9687](#) – LH reel (without hoses)****
- 3 REF [107TA3690](#) – Hose, 6 m, end connection 1/4" JIC*/***
- REF [107TA3691](#) – Hose, 5 m, end connection 5/16" JIC**/****
- 4 REF [107TA3688](#) – Fitting*/**/****/***** (2 required)
- REF [107TA3689](#) – Fitting*/**/****/***** (4 required)
- 5 REF [107TA3685](#) – Swivel*/**/****/*****

*/** Kit included for RH, ***/**** Kit included for LH

5

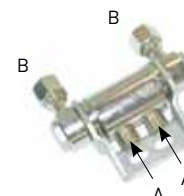

A Inlet adaptor pipe 10L, thread: M16 x 1,5
B Outlet adaptor pipe 10S, thread: M18 x 1,5

TECALEMIT REEL

Type	Reel diameter	Max hose length	Hose type	REF
1 Complete kit				
RH*	390 mm	7 m	Double synflex 1/4"	107TA3718
RH**	390 mm	6 m	Double synflex 5/16"	107TA3719
LH***	390 mm	7 m	Double synflex 1/4"	107TA3720
LH****	390 mm	6 m	Double synflex 5/16"	107TA3721



- 2 REF [107TA3714](#) – RH reel (without hoses)**
- REF [107TA3715](#) – LH reel (without hoses)****
- 3 REF [107TA3716](#) – Hose, 7 m, end connection 1/4" JIC*/***
- REF [107TA3717](#) – Hose, 6 m, end connection 5/16" JIC**/****
- 4 REF [107TA3688](#) – Fitting*/**/****/***** (2 required)
- REF [107TA3689](#) – Fitting*/**/****/***** (4 required)
- 5 REF [107TA3685](#) – Swivel*/**/****/*****

*/** Kit included for RH, ***/**** Kit included for LH

5

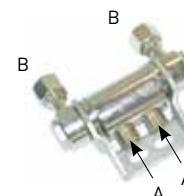

A Inlet adaptor pipe 10L, thread: M16 x 1,5
B Outlet adaptor pipe 10S, thread: M18 x 1,5



SWIVELS



	9/16" Jic	REF 3/4" Jic
Complete kit	REF 135TA9669	REF 151TA2971
Swivel	REF 135TA9670	REF 151TA2972
Fitting	REF 107TA3749	REF 107TA3745
Bracket	REF 107TA3750	REF 107TA3746

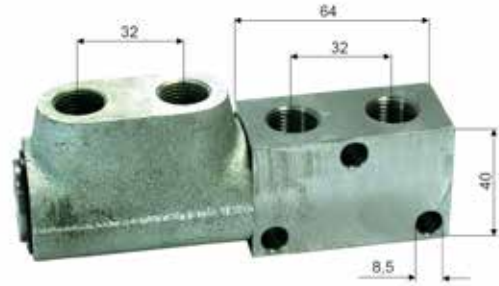

REF [123TA7201](#)

- Bolt on swivel - length 136 mm
- Inlet thread: 3/8" BSP
- Outlet thread: 3/8" BSP
- 3 mounting holes 8,5 mm

REF [123TA7202](#) (without fittings)

- Bolt on swivel - length 264 mm
- Inlet thread: 3/8" BSP
- Outlet thread: 3/8" BSP
- 6 mounting holes 8,5 mm
- Rotating angle 180°

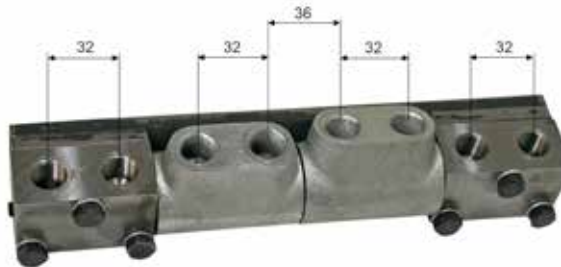

With fittings:

REF [123TA8866](#)

- With 8 fittings 9/16" JIC

JUNCTION BLOCKS FOR HOSE REELS



REF [107TA3741](#)

- Type: 1JC
- Inside thread: 9/16 UNF
- Connection of the hose:
1 hose left- and 1 hose right-hand



REF [107TA3742](#)

- Type: R
- Inside thread: 3/4 UNF
- Connection of the hose:
2 hoses right-hand



REF [107TA3739](#)

- Type: C
- Inside thread: 3/4 UNF
- Connection of the hose:
1 hose left- and 1 hose right-hand



REF [107TA3740](#)

- Type: L
- Inside thread: 3/4 UNF
- Connection of the hose:
2 hoses left-hand



SWIVEL JOINT FOR 2 HOSES

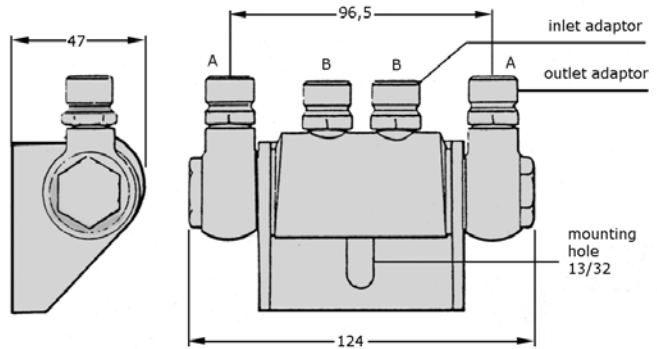
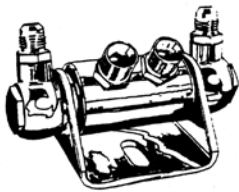

Specifications	Pressure drop	
Flow	19 litres	38 litres
REF 112TA4966 (with check valve)	2,8 bar	8,5 bar
REF 112TA4967 (without check valve)	2,0 bar	6,8 bar

- Pressure range up to 300 bar
- 180° rotatable
- Swivel joints are available with or without check valve

Outlet adaptor	Inlet Adaptor	REF with valve	REF without check valve
-	-	112TA4966	112TA4967
1/4" BSP	1/4" BSP	112TA4968	112TA4981
3/8" BSP	3/8" BSP	112TA4969	112TA4982
9/16" JIC	9/16" JIC	112TA4970	112TA4983
3/4" 16 UNF	3/4" 16 UNF	112TA4971	112TA4984
M16x1,5 [24°]	M16x1,5 [24°]	112TA4972	112TA4985
3/8" BSP	1/4" BSP	112TA4973	112TA4986
3/8" BSP	9/16" JIC	112TA4974	112TA4987
1/4" BSP	9/16" JIC	112TA4975	112TA4988
9/16" JIC	3/8" BSP	112TA4976	112TA4989
9/16" JIC	1/4" BSP	112TA4977	112TA4990
9/16" JIC	-	112TA4978	112TA4991
M18x1,5	3/8" BSP	112TA4979	112TA4992
M16x1,5 [60°]	M16x1,5 [60°]	112TA4980	112TA4993

SWIVEL JOINT FOR 4 HOSES

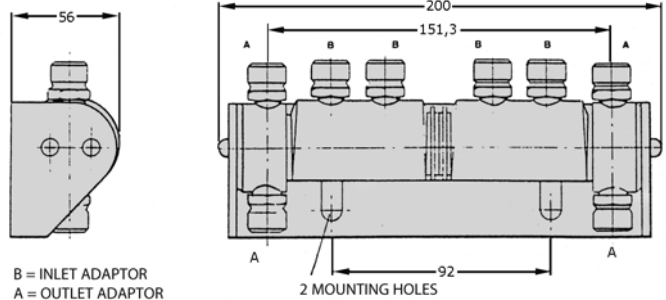
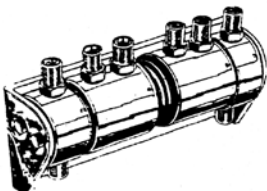

B = INLET ADAPTOR
A = OUTLET ADAPTOR

Specifications	Pressure drop	
Flow	19 litres	38 litres
REF 112TA4994	2,3 bar	9,5 bar

- Pressure range up to 210 bar
- 180° rotatable

Outlet adaptor	Inlet Adaptor	REF without check valve
-	-	112TA4994
3/8" BSP	3/8" BSP	112TA4995
1/4" BSP	1/4" BSP	112TA4999
9/16" JIC	9/16" JIC	129TA8815
1/4" BSP	9/16" JIC	112TA4997
3/4"-16 UNF	9/16" JIC	129TA8816



23

ACCESSORIES



OILCOOLER

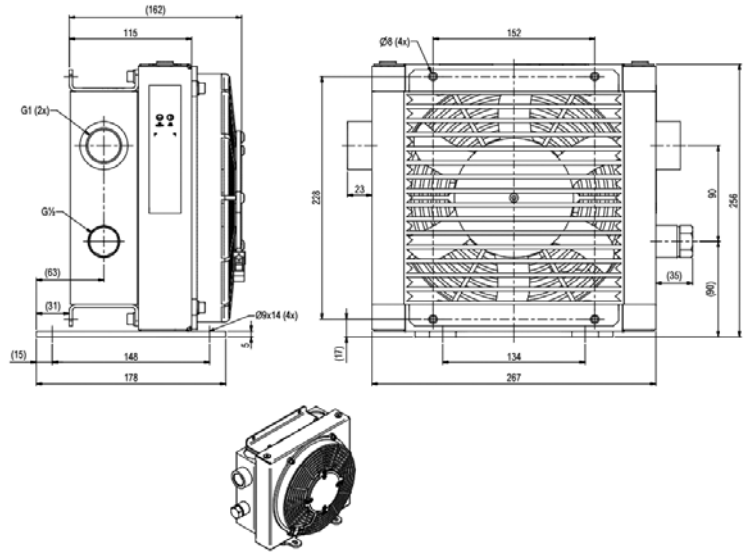

REF 152TA1962

Voltage: 12 VDC

REF 152TA1963

Voltage: 24 VDC

- 25 l/min to 120 l/min
- Inclusive thermocontact till 47° C
- Work pressure: 10 bar
- P max: 14 bar

VISUAL LEVEL INDICATOR

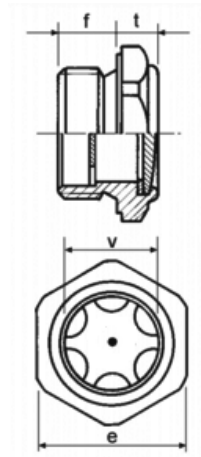

Thread	f	t	v	e	REF
G 3/8"	10,5	7	13	22	152TA1967
G 1/2"	11	9	16	27	152TA1968
G 3/4"	12	9	21	32	152TA1969
G 1"	15,5	10	27	40	152TA1970
G 1" 3/4	15	10	37	50	152TA1971
M 33 x 2	15,5	10	27	40	152TA1972



VERTICAL LEVEL INDICATOR

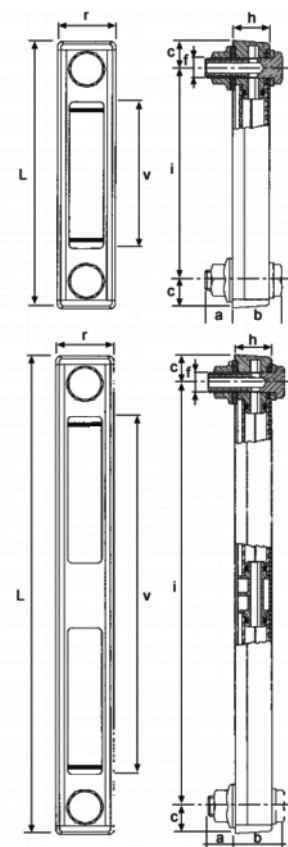

L	r	v	c	i	f	h	a	b	REF
109	34	37	16,5	76	M 10	21,5	11	29	152TA1973
109	34	37	16,5	76	M 12	21,5	11	29	152TA1974
160	34	88	16,5	127	M 10	21,5	16	29	152TA1975
160	34	88	16,5	127	M 12	21,5	16	29	145TA8289



24

HYDRAULIC INDICATORS & TESTERS



ANALOG PRESSURE GAUGES



PRESSURE GAUGES FOR OIL

- Connection 1/4" BSP
- Case: Ø 63
- Stainless steel
- Filled with glycerine

bar	PSI	REF
0 - 1	0 - 15	107TA4308
0 - 1.6	0 - 23	107TA4315
0 - 2.5	0 - 35	107TA4309
-1 - +3	-1 - +40	107TA4310
0 - 4	0 - 60	107TA4311
0 - 6	0 - 80	107TA4312
0 - 10	0 - 150	107TA4313
0 - 16	0 - 230	107TA4314
0 - 25	0 - 350	107TA4316
0 - 40	0 - 600	107TA4317
0 - 60	0 - 850	107TA4318
0 - 100	0 - 1500	107TA4319
0 - 160	0 - 2300	107TA4320
0 - 250	0 - 3600	107TA4321
0 - 400	0 - 5800	107TA4322
0 - 600	0 - 8450	107TA4323



PRESSURE GAUGES FOR OIL

- Connection 1/4" BSP
- Case: Ø 63
- Stainless steel
- Filled with glycerine
- **Connection on the back side**

bar	PSI	REF
-1 - +3	-1 - +40	107TA4298
0 - 6	0 - 80	107TA4299
0 - 10	0 - 150	107TA4300
0 - 16	0 - 230	107TA4301
0 - 25	0 - 350	107TA4302
0 - 40	0 - 600	147TA5166
0 - 60	0 - 850	107TA4303
0 - 100	0 - 1500	107TA4304
0 - 160	0 - 2300	107TA4305
0 - 250	0 - 3600	107TA4306
0 - 400	0 - 5800	107TA4307
0 - 600	0 - 8750	144TA6927



ANALOG PRESSURE GAUGES

MULTI-PRESSURE TESTER

Pressure testing devices for hydraulic, air and vacuum systems.

REF 107TA4297

Technical information:

- Glycerine-filled gauge for a safe read-out
- Built-in valve protects device against high pressures
- Readings in PSI (pounds/inch²) or bar (kgf/cm²)
- Dust and moisture resistant
- Compact, provided with a 90 cm flexible hose,
- 1/8" NPTF connection
- Compatible with most hydraulic fluids

LOW-PRESSURE GAUGE

Pressure/vacuum readings from -1 to 20 bar

HIGH-PRESSURE GAUGE

Pressure readings from 0 to 400 bar

MIDRANGE PRESSURE GAUGE

Pressure readings from 0 to 60 bar



ACCESSORIES FOR ANALOG PRESSURE GAUGES



PRESSURE GAUGE SUPPORT

to connect the pressure gauge to a wall

REF 147TA5168



RUBBER PROTECTION

for ø 63 mm pressure gauges (blue)

REF 147TA5165 - (blue)



ACCESSORIES FOR ANALOG PRESSURE GAUGES

PRESSURE GAUGE SELECTOR

- Connections:** 6 x P
- Bar:** 400
- Thread:** 1/4
- M BSPP:** G 1/4
- P BSPP:** G 1/4
- T BSPP:** G 1/4

REF [133TA9269](#)

- For reading 6 pressures without permanent pressure on pressure gauge
- Prevents damages to pressure gauge caused by peak pressures
- Extends the life of the gauge considerably



400 Bar

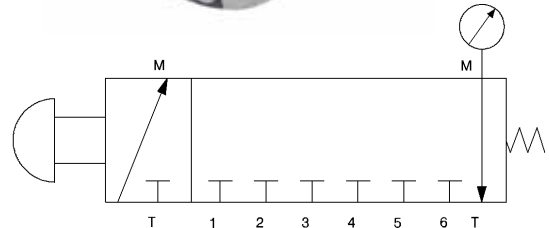

DIGITAL PRESSURE GAUGES

- Digital measuring and displaying of pressures
- Accuracy typ. 0,5% FS (full scale)
- Capturing pressure peaks
- Easy operation, robust and reliable
- Battery life time cycle 1.500 hrs

DIGITAL PRESSURE GAUGES

Digital pressure gauge with pressure peak display



bar	PSI	REF
0 - 100	0 - 1500	116TA5801
0 - 400	0 - 5800	116TA5802
0 - 600	0 - 8750	116TA5803

DIGITAL PRESSURE GAUGE KITS

The kit is the ideal tool for every application in service, maintenance and repair of hydraulic systems. Depending on the pressure ranges you can choose between 3 variants. This kit is delivered in a durable case.

The kit can be used for quick and reliable troubleshooting.

Kit contains:

- 1 digital manometer
- 1 test hose 1.5 m



bar	PSI	REF
Kit 0-100	0 - 1500	116TA5807
Kit 0-400	0 - 5800	116TA5805
Kit 0-600	0 - 8750	116TA5806



DIAGNOSTIC SERVICE KITS

BASIC PRESSURE MEASURING KIT

This kit contains the most basic components to diagnose the hydraulics.

All this is included in a durable case.

REF 147TA5184

Contents:

- 1 manometer 0 – 40 bar (0 – 600 PSI)
- 1 manometer 0 – 400 bar (0 – 6000 PSI)
- 1 test point: 1/8" BSP
- 1 test point: 1/4" BSP
- 1 test hose: 2 m
- 1 coupling: 1/4" BSP -> 3/8" BSP
- 1 coupling: 1/4" BSP -> M 18



GENERAL PRESSURE MEASURING KIT

This diagnostic service case has all the general components to diagnose the hydraulics on your machine.

All these items are included in a durable case.

REF 147TA5167

Contents:

- 1 Digital manometer 0 – 600 bar
- 1 Test hose 1,5 m
- 11 Testcouplings in metric, BSP and UNF thread



PRESSURE MEASURING KIT

This diagnostic service case has all the required components to diagnose the hydraulics on your machine.

Used for general diagnostics on LINDE machines.

REF 134TA2344

Contents:

- All these items are included in a very durable ABS case
- Test points in various dimensions: M8 – M10 – M12 – M14
 - There are also test points with adaptors included to fit inside your machine
 - Test hoses in different lengths: 1 hose with length 1,5 m and 2 hoses with length 1 m
 - Hose caps in various dimensions to diagnose your piston pump
 - Analog pressure gauges with different ranges: 1 pressure gauge with a 0–600 bar range and 2 pressure gauges with a 0–60 bar range

Other test points, test hoses and pressure gauges are available from stock. Please contact the sales department.





DIAGNOSTIC SERVICE KITS

UNIVERSAL ACCUMULATOR PRESSURE CONTROL KIT

This kit enables you to check or to change the pressure of a Hydraulic accumulator. Discharging the accumulator is also possible with this kit.

Compatible with all hydraulic accumulator connections.

All this comes in a durable, lightweight case.

REF [134TA2343](#)

Contents:

- Charging valve
- 1 Gauge 0 - 25 bar
- 1 Gauge 0 - 250 bar
- 5 Most used accumulator connections (3/4 BSP; M16 x 2; M28 x1,5; 5/8 UNF; 7/8 UNF)
- Adapters to connect French and German nitrogen bottles
- 2,5 m hose to connect the valve to bottle





HYDRAULIC FLOW INDICATORS

BASIC FLOW INDICATORS

These in-line flow indicators are designed for trouble shooting the hydraulics of the machine. They can be mounted in any orientation and are weather proof for outside use. Pressure up to 240 bar (3500 PSI) are acceptable. Operating temperatures may not exceed 110° C (240 °F).



Ports	Flow range	REF
1/2" BSP	2 - 18 l/min (0,5 - 5 US gpm)	147TA5164
3/4" BSP	12 - 113 l/min (3 - 30 US gpm)	147TA5163

FLOW AND TEMPERATURE INDICATOR

This indicator can measure flow and temperature of your hydraulic system.

REF [134TA2635](#)

Technical specifications:

- Flow range: 10 to 200 l/min (0-50 US gpm)
- Pressures up to 280 bar (4000 PSI)
- Temperature: up to 110° C (230 °F)
- 1 1/2" BSP Port size
- Possibility to connect a pressure gauge with minimes



FLOW INDICATOR WITH LOADING VALVE TO 120 L/MIN

This indicator can measure flow, temperature and pressure of your hydraulic system in both directions.

REF [134TA2637](#)

Technical specifications:

- Flow range: 5 to 120 l/min (1,3 - 32 US gpm)
- Pressures up to 420 bar (6000 PSI)
- Temperature: up to 110° C (230 °F)
- 1" BSP Port size





HYDRAULIC FLOW INDICATORS

FLOW INDICATOR WITH LOADING VALVE TO 200 L/MIN

This indicator can measure flow, temperature and pressure of your hydraulic system in both directions.

REF 143TA5650

Technical specifications:

- Flow range: 10 to 200 l/min (2,5 – 54 US gpm)
- Pressure: 0 - 420 bar (6000 PSI)
- Temperature: up to 110° C (230 °F)
- 1" BSP Port size



DIGITAL HYDRAULIC TESTER

This hydraulic tester shows the flow and temperature digitally with the push of a button.

The pressure is shown analogue. It comes with a built-in loading valve, which enables you to test the system. The tester can be used in both directions which simplifies the testing. The device is robust, portable and lightweight.

All these items are included in a very durable steel case.

REF 134TA2639

Technical specifications:

- Flow range: 10 – 400 lpm (2,5 – 100 US gpm)
- Pressure: 0 - 420 bar (6000 PSI)
- Temperature up to 120 °C (250 °F)
- 1" BSP Port size

Please contact the sales division if you are interested in a more heavy duty version.





MINIMESS SYSTEM

MINIMESS TEST COUPLINGS M16 X 2 SYSTEM

Dimensions	REF
M10 x 1	147TA5169
M12 x 1.5	147TA5170
M14 x 1.5	147TA5171
M16 x 1.5	147TA5172
1/8 BSP	147TA5173
1/4 BSP	147TA5174
3/8 BSP	147TA5175
7/16 UNF	147TA5176
9/16 UNF	147TA5177
3/8 UNF	147TA5178



DIRECT GAUGE ADAPTER



REF [163TA8687](#)

TESTHOSE

HYDRAULIC TEST HOSE M16 X 2 SYSTEM MAX P (630 BAR)

Other lengths and connectors also available. Please contact your sales advisor.

Dimensions	Length	REF
M16 x 2 - M16 x 2	1 m	147TA5179
M16 x 2 - M16 x 2	1,5 m	147TA5180
M16 x 2 - M16 x 2	2 m	147TA5181



TESTHOSE COUPLER

Max P 630 bar

REF [143TA5681](#)

Technical specifications:
2 times M16 x 2



PRESSURE GAUGE TO TEST HOSE COUPLING

Max P 630 bar

REF [147TA5183](#)

Technical specifications:

- Manometer side: 1/4" BSP
- Test hose side: M16 x 2



PLUG IN SYSTEM



Dimensions	REF
M8	163TA8688
M10	163TA8689

CONVERTOR ADAPTOR

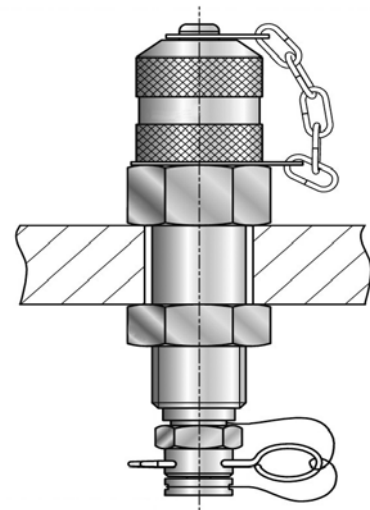

REF [163TA8690](#)
M16 x 2 system <-> Plug in system



25

TOOLS



HAND PRESS



REF 105TA4798

Technical specifications:

- This press is mobile
- Possibility to press near the machine itself, so no need to remove the hose
- Ideal to use on-site
- Die sets 16 - 14 -> 16 - 31 included (6 sets in total)

PRESS FOR HYDRAULIC HOSES - 1 1/4"



REF 139TA3146

Technical specifications:

- Maximum hose dimensions: 1 1/4"
- Crimping capacity: 1500 kN
- Maximum crimping diameter: 55 mm
- Maximum opening: die diameter + 26 mm
- Standard motor: 3,6 kW - 380 V - 3-phase (different voltages available)
- Control digital controller
- Main die opening/length: 124/80 mm
- Crimping range 10 - 55 mm
- Weight: 250 kg (including oil) - sold without oil
- Dimensions (L x W x H): 600 x 480 x 1300 mm
- Die sets standard: 10 - 13 - 16 - 19 - 22 - 26 - 30 - 34 - 39 - 45
- Quick change-set
- Foot pedal or back stop device
- Stand for machine
- Oil not included



CUTTING MACHINE

REF 139TA1911

Mobile cutting machine for flexible hoses up to 1"-4" wires

Use:

New model, particularly suitable for cutting flexible hoses, electrical cables, metal- and plastic-covered hoses ... one by one or in small batches. Easily transportable, the only power supply required is a simple 220 V single-phase 10 A socket. This model is ideal for on-site work.

Technical specifications:

- Maximum cutting diameter: 50 mm
- Bevelled cutting blade: Ø 200 x 1,6 x 30 mm
- Dimensions (H x W x L): 530 x 430 x 550 mm
- Weight: 17 kg
- Bench mode
- Manual control
- Single lever to bend and cut hoses
- 2,1 kW - 230 V - 50 Hz single-phase electric motor with hold-to-run control



HOSE CUTTING AND SKIVING MACHINE (TYPE TD6)

REF 139TA3164

Manual cutting machine for hydraulic hoses up to 2" - 4 layers.

Technical specifications:

- Capacity: 2" - 4 steel layers
- Max cutting diameter: 100 mm
- Bevelled cutting blade: Ø 400 x 4 x 30 mm
- Brush: Ø 200 x 25 x 25 mm
- Dimensions H x L x W: 500 x 750 x 670 mm
- Weight: 90 kg
- Bench model
- 5 kW - 400 V - 50 Hz - three-phase high torque electric model
- Direct starting protected by heat sensor
- Equipped with 11 interchangeable gauges from Ø 4 to 50 mm



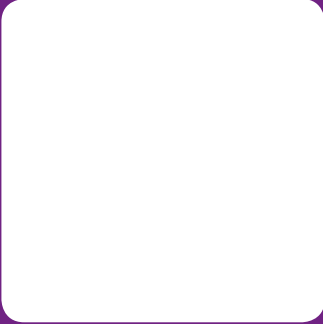

26

**MAINTENANCE,
REPAIR &
OPERATIONS**



ASHLESS MINERAL HYDRAULIC FLUID WITH A VERY HIGH VISCOSITY INDEX

REF 140TA8776 – 20 l, ISO VG 15

Product description:

- A hydraulic fluid designed for outdoor equipment operating under extremely low temperatures
- The very high viscosity index extends the temperature operating window of the hydraulic systems

International specifications:

- ISO 11158 HV
- DIN 51524-3 HVLP

Advantages:

- The low cold-temperature viscosity is limiting the cavitation issues during the start-up operations. With this low viscosity level the hydraulic system can be fully operable immediately after the start-up
- Good shear stability ensuring the high temperature lubricating film thickness and the hydraulic pump efficiency during all the fluid life
- Ashless formulation offering a very high oxidation stability, reducing deposits and varnishes formation and allowing extended drain intervals
- Good wear, rust and corrosion protection of the material
- Excellent air release behaviour



TOTAL SOURCE
Powered by TOTAL

HIGH VISCOSITY INDEX ANTI-WEAR HYDRAULIC OILS

REF 107TA7211 – 1 l, ISO VG 15

REF 107TA7212 – 5 l, ISO VG 15

REF 141TA5202 – 20 l, ISO VG 22

REF 141TA2734 – 20 l, ISO VG 32

Product description:

- Recommended for all kind of hydraulic systems operating under high pressure (limit as indicated by the pump manufacturer) and high temperature (up to 100 °C in hot points)
- Lubricants especially suitable for hydraulic systems working under extreme temperature variations and equipment operating outside: easy start-up at low temperature (-30 °C) and regular operating in all seasons: civil engineering, agriculture, marine, transport and other industrial applications

International specifications:

- Afnor NF E 48-603 HV
- ISO 6743/4 HV
- DIN 51524 P3 HVLP
- Cincinatti Milacron P68, P69, P70
- Vickers M-2950S, -I-286

Advantages:

- Very high viscosity index
- Excellent shear stability
- Superior thermal stability avoiding the formation of sludge even at high temperatures
- Very good oxidation stability ensuring a long service life of the fluid
- High protection against wear ensuring maximum equipment life
- Excellent hydrolytic stability avoiding filter blocking
- Remarkable filterability even in the presence of water
- Excellent protection against rust and corrosion
- Good anti-foam and air release properties by using silicon-free components
- Very low pour point
- Good demulsibility ensuring rapid water separation



TOTAL SOURCE
Powered by TOTAL



BIODEGRADABLE HYDRAULIC FLUIDS

- REF 141TA2739** – 20 l, ISO VG 46
- REF 138TA3968** – 20 l, ISO VG 68
- REF 141TA2738** – 208 l, ISO VG 68

Product description:

- A biodegradable synthetic hydraulic fluid offering good lubricating properties. It was designed for demanding hydraulic systems requiring hydraulic fluids with reinforced anti-wear properties
- Recommended for use when incidental spillage in environmentally sensitive areas can occur, e.g.: forestry works, navigation, off-shore, water catchment areas, ski resorts, hydroelectric stations ...

Specifications:

- ISO 15380 HEES



Advantages:

- Produced with renewable raw materials, this oil contributes to CO2-emission reduction

- High natural viscosity index gives a wide temperature operating window (-20 °C to 80 °C)
- The very high shear stability will ensure the hydraulic equipment is kept to an optimum efficiency during the fluid service life
- The good lubricating properties, as well as the very good wear and corrosion protection, extends the life of the hydraulic system's moving components



TOTAL SOURCE
Powered by TOTAL

BIODEGRADABLE HYDRAULIC FLUIDS SUITABLE FOR INCIDENTAL FOOD CONTACT

- REF 138TA3967** – 20 l
- REF 141TA2742** – 208 l

Product description:

- Oil for hydraulic systems presenting risks of leaks of fluid into the environment and incidental contact with foodstuffs: grape harvests, crop harvests ...
- Operating temperatures: -20 °C to 70 °C

Specifications:

- NSF H1
- ISO 15380 HETG
- Poclairn Hydraulics 11-06
- ISO 6743-4

Advantages:

- Reinforced protection and efficiency of equipment due to a very high viscosity index
- Excellent anti-wear properties



TOTAL SOURCE
Powered by TOTAL



FLEXIBLE DRAINING TOOL

REF 139TA6262

- For draining & pouring of liquids in applications where rigid funnels are too big
- Bends, molds & holds any shape
- Leakproof
- As versatile in dry as in wet applications
- Store flat or roll up to take along in your toolbox or glove compartment
- 100% aluminium permanently sealed inside of a heavy coating of flexible nitrile rubber
- Dimensions: 370 x 165 mm
- Bend sides to create a small parts tray, scoop & much more
- Works in temperatures from -34 °C to 218 °C



REF 143TA6515

Dimensions: 370 x 170 mm

REF 143TA6516

Dimensions: 410 x 200 mm

POLYETHYLENE FUNNEL WITH CAP

REF 107TA7277

- Capacity: 3,2 l
- For waste oil or chemical disposal
- With connection G2" for barrel of 60/200 l
- Diameter: 250 mm



BARREL FUNNEL

REF 107TA7237

- Suitable for 200 l barrels
- Extra high capacity
- Supplied with hinged cover
- Outer diameter: 610 mm
- Height: 230 mm
- Weight: 4 kg
- Colour: yellow



POLY-RECEPTACLES

REF 107TA7242

- Capacity: 240 l
- For 2 barrels
- Barrels not included





ABSORBING TOWELS



REF 107TA7236

- 410 x 510 mm
- 100 pieces/box
- Absorbs about everything (oil, liquids, acids ...)

BARREL TOP MAT

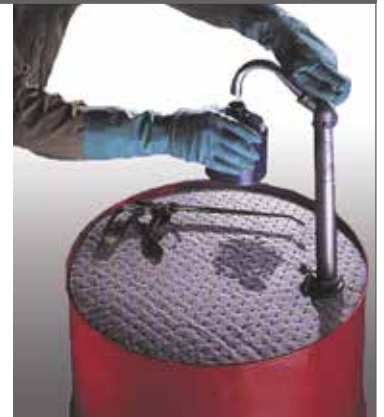

REF 107TA7235

Set of 25 sheets

ABSORBING GRANULES



REF 107TA7234

- Oil absorbing granules
- 20 kg

OIL GRIP FULLY COATED

- REF 143TA7000** – Size: S
- REF 143TA7001** – Size: M
- REF 143TA6997** – Size: L
- REF 143TA6998** – Size: XL
- REF 143TA6999** – Size: XXL

Applications:

- Mechanical assembly and subcontracting (automotive industry)
- Construction and public works
- Petrochemistry

Advantages:

- New liquid repellent technology
- Excellent grip in an oily environment

Standard:

- Cat II
- EN 420
- EN 388:4131



Honeywell



CLEANING AGENT JIZER

REF [142TA8244](#) – 25 l
REF [142TA8245](#) – 4 x 5 l

- Soluble and biodegradable degreaser
- Versatile, liquid cleaner, developed for the removal of grease, oil, wet paint, ink, tar and asphalt
- Very economical when used in a closed flushing system, can absorb up to 5 times the own volume in dirt
- User-friendly
- Not suitable for use in a high-pressure cleaner



HAND CLEANER WIPES

REF [147TA3378](#)

- Fast and easy hand cleaning without water and soap
- Pleasantly scented
- Efficient against heavy greases, lubricants, sludge, fresh paints ...
- Scrubs tools, mechanical parts, whiteboards ...
- 100 orange wipes



REF [147TA3380](#) – Wall bracket

TOTALSOURCE

CLEANING TISSUE



REF [106TA6744](#)

- White
- 600 m x 240 mm
- 2 rolls

TOTALSOURCE

Floor-mounting dispenser

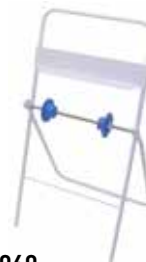

REF [140TA9060](#)
Rolls excluded

Wall-mounting dispenser



REF [107TA8503](#)
Rolls excluded

OIL SEAL TOOL KIT

REF [127TA3804](#)

Oil seals are durable and versatile components, whose functionality depends to a great extent upon their being properly installed. Thus, for example, up to 30% of early failures of rotary shaft seals are traceable to faulty installation. We offer an assembly set that minimizes installation errors and simplifies deinstallation.





O-RING GAUGE



REF 115TA6899
From diameter 2 to 20 mm



REF 115TA6900
From diameter 20 to 100 mm



REF 115TA6901
From diameter 100 to 160 mm

SEAL ASSEMBLY KIT



REF 140TA9070
For easy fitting and detaching of o-rings without any damage



CIRCUMETER



REF 141TA1322
Measuring tape for outside diameter and circumference (diameter: 20-300 mm)

SEAL CUTTER



REF 141TA1323
Cutter for guide rings

SEAL CLASPER



REF 141TA1324
Tool for clasping PTFE piston seals back into the groove

SEAL ASSEMBLY KIT



REF 141TA1325
Easy fitting and detaching of seals without any damage



THREAD SEALANT FOR HYDRAULIC CONNECTIONS

REF 143TA3470

- For metal, especially hydraulic pipes
- Max thread size: M80/R3"
- Service temperature range: -55 to 150 °C
- Disassembly strength: medium
- Breakaway torque: 15 Nm
- Viscosity: 400–800 mPa·s
- 50 ml



Loctite 542 is ideal for fine threads as used in hydraulic, pneumatic & general fittings.

LOCTITE

MEDIUM STRENGTH THREADLOCKER

REF 143TA3461 – 5 ml

REF 143TA3463 – 10 ml

REF 143TA3459 – 50 ml

- Medium strength, general purpose, oil tolerant
- Max thread size: M36
- Service temperature range: -55 to 150 °C
- Strength: medium
- Breakaway torque: 26 Nm
- Viscosity: 1300–3000 mPa·s
- Fixture time: 10 min
- P1 NSF

Loctite 243:

- Works on all metals, including passive substrates (e.g. stainless steel, aluminium, plated surfaces)
- Proven to tolerate slight contaminations of industrial oils, e.g. engine oils, corrosion prevention oils and cutting fluids
- Prevents loosening on vibrating parts, e.g. pumps, gear boxes or presses
- Permits disassembly with hand tools for servicing



LOCTITE

ACTIVATOR

REF 143TA3570

- Speed up cure on passive and inactive surfaces
- For large bond gaps
- On-part life of: Loctite 7649: ≤30 days
- 150 ml

Loctite 7649 is used where increased cure speed of Loctite anaerobic products is required. It is especially recommended for applications with passive metals or inert surfaces and with large bond gaps. Loctite 7649 is particularly recommended when prevailing temperature is low (<15 °C).



LOCTITE



FAST DRY DEGREASER

REF [143TA6893](#)

- A fast and powerful solvent cleaner which maintains peak operating performance
- Quickly dissolves grease, oil, lubricants, tar and adhesives from all metal parts
- Leaves no residue
- Safe on most plastics, coatings and rubbers
- 500 ml



STARTER WRENCHES – METRIC



Dimensions	Beta		Force		Elora	
	Length	REF	Length	REF	Length	REF
8 x 10 mm	126 mm	142TA7237	141 mm	142TA4027		
10 x 12 mm	137 mm	142TA7238	141 mm	142TA4028		
11 x 13 mm	138 mm	142TA7239	166 mm	142TA4029		
12 x 14 mm			166 mm	142TA4030		
13 x 15 mm			190 mm	142TA4031		
13 x 17 mm					190 mm	142TA4024
14 x 16 mm					190 mm	142TA4025
14 x 17 mm	183 mm	142TA7240	190 mm	142TA4032		
16 x 18 mm	196 mm	142TA7241	220 mm	142TA4033		
17 x 19 mm			220 mm	142TA4034		
19 x 21 mm					220 mm	142TA4026
19 x 22 mm	231 mm	142TA7242	256 mm	142TA4035		





STARTER WRENCHES - INCH



Dimensions	Beta		Force		Elora	
	Length	REF	Length	REF	Length	REF
7/16" x 1/2"	138 mm	142TA7243				
1/2" x 9/16"					164 mm	142TA4036
9/16" x 5/8"	183 mm	142TA7244				
5/8" x 3/4"					200 mm	142TA4037
11/16" x 3/4"			137 mm	142TA4038		
3/4" x 7/8"	230 mm	142TA7245				



FLARE NUT WRENCHES - METRIC



Dimensions	Beta		Force		Elora	
	Length	REF	Length	REF	Length	REF
8 x 10 mm	140 mm	142TA7270	145 mm	142TA4119	150 mm	142TA4112
9 x 11 mm	153 mm	142TA7271	150 mm	142TA4127	150 mm	142TA4113
11 x 13 mm	175 mm	142TA7272	165 mm	142TA4120	165 mm	142TA4128
12 x 14 mm	175 mm	142TA7273	178 mm	142TA4121	190 mm	142TA4114
13 x 15 mm					190 mm	142TA4115
14 x 15 mm	175 mm	127TA4482				
14 x 16 mm					200 mm	142TA4116
16 x 18 mm			210 mm	142TA4122	210 mm	142TA4129
17 x 19 mm	212 mm	142TA7274	210 mm	142TA4123	210 mm	142TA4117
19 x 22 mm	228 mm	142TA7275	233 mm	142TA4124	230 mm	142TA4130
24 x 27 mm	260 mm	142TA7276	265 mm	142TA4125	260 mm	142TA4131
30 x 32 mm	300 mm	142TA7277	385 mm	142TA4126	288 mm	142TA4132



FLARE NUT WRENCHES - INCH



Dimensions	Force		Elora	
	Length	REF	Length	REF
5/16" x 3/8"	145 mm	142TA4133	150 mm	142TA4140
3/8" x 7/16"	152 mm	142TA4134	165 mm	142TA4141
9/16" x 5/8"			200 mm	142TA4142
7/16" x 1/2"	165 mm	142TA4135		
1/2" x 9/16"	178 mm	142TA4136		
5/8" x 3/4"	210 mm	142TA4137	210 mm	142TA4143
11/16" x 3/4"	210 mm	142TA4138		
3/4" x 7/8"	233 mm	142TA4139	230 mm	142TA4144

6 PIECE FLARE NUT WRENCH SET - METRIC



REF [143TA3792](#)

Contents:

6 flare nut wrenches: 8 x 10 - 10 x 11 - 11 x 13 - 12 x 14 - 17 x 19 - 19 x 22 mm





19 PIECE 1/2" SOCKET AND ACCESSORIES SET - METRIC

REF [142TA5902](#)

Contents:

- 14 hexagon sockets:
10 - 11 - 12 - 13 - 14 - 15 - 16 - 17 - 19 -
22 - 24 - 27 - 30 - 32 mm
- 1 x 32-teeth ratchet
- 1 sliding T-handle
- 2 extensions: 125 - 250 mm
- 1 universal joint



4 PIECE PRECISION CIRCLIPS PLIERS SET

REF [142TA1013*](#)

- Attractive sales packaging with Euro standard perforation
- Contains common precision circlips pliers for highest requirements
- Sturdy plastic packaging, also suitable for storage of the pliers
- 4 parts

Contents:

Description	REF
○ Precision circlips pliers, to assemble internal circlips into bores - straight tip, Ø 12-25 mm	142TA1014
○ Precision circlips pliers, to assemble internal circlips into bores - straight tip, Ø 19-60 mm	142TA1015
○ Precision circlips pliers, to assemble external circlips on shafts - straight tip, Ø 10-25 mm	142TA1016
○ Precision circlips pliers, to assemble external circlips on shafts - straight tip, Ø 19-60 mm	142TA1017



SCREW PITCH GAUGE

REF [142TA3012](#)

- Metric 60°: 0,25÷6
- Whitworth 55°: 62÷4x1"
- Weight: 75 g





PIPE BENDING TOOL

REF 124TA7495

Available sizes:

Diameter	Radius
12 mm	6 mm R
16 mm	8 mm R
20 mm	10 mm R
24 mm	12 mm R
30 mm	15 mm R

- Designed to bend hydraulic pipes to 180° for diameter 6 mm up to 15 mm
- Extra small bend radius R=2D
- Can be used in a bench-vice
- Possible to bend to the right and to the left
- Easily replaceable bend mould, clamp block and bend arm
- Unique system ensuring qualitative bending with minimal efforts
- Available as a set or per diameter
- Other bend radiuses and diameters on request
- Optional:
 - Stroke length of 500 mm with 1 stroke
 - Loose strokes

