

Katalog



SEC Gummilaufketten & Fahrwerkersatzteile



Über TVH

- Über TVH I-IV

Gut zu wissen

- Gut zu wissen 1
- Technisches Datenblatt 9

Gummilaufketten & fahrwerkersatzteile verwendet für:

- AICHI 17
- AIRMAN 21
- ATLAS 23
- BOBCAT 25
- CASE 95
- CATERPILLAR 105
- DAEWOO 115
- DOOSAN 117
- FAI 123
- FIAT HITACHI 125
- GEHL 127
- HANIX 135
- HINOWA 139
- HITACHI 143
- HYUNDAI 159
- IHI 177
- JCB 191
- JLG 201
- KOBELCO 205
- KOMATSU 219
- KUBOTA 275
- LIBRA 293
- MESSERSI 297
- MITSUBISHI 299
- MOROOKA 303
- NEUSON 307
- NEW-HOLLAND 331
- O&K 337
- PEL JOB 339
- SHAEFF 345
- SUMITOMO 349
- SUNWARD 351
- TAKEUCHI 353
- TEREX 365
- VENIERI 369
- VOLVO 371
- YANMAR 383
- YGRY 409
- YUCHAI 411

Wartung, Reparatur & Instandhaltung

- Universeller 3-armiger Abzieher 414
- 1" langer Sechskant Schlag-Steckschlüssel - metrisch 414
- 11-teiliges 3/4" Sechskant Schlag-Steckschlüssel Set- metrisch 415
- Schlagschrauber 415
- Tragbare hydraulische Heber 416
- Flexibler Trichter 417
- Polyethylen-Trichter mit Deckel 417

- Fass-Trichter 417
- Batteriebetriebene Fettpresse 418
- Industriefettpresse 418
- Gashahn Fett 418
- Magnetische wiederaufladbare LED-Warnleuchte 419
- Aerial Tool Bin 419
- Schutzabdeckung 420
- Hochdruck-Mehrzweck-Lithium-/Kalziumfett - NLGI 2 420
- Hochfeste Schraubensicherung 421
- Fügeverbindung 421
- Bodenträger Platten 422



TRACK ROLLERS

Inner guide TRACK ROLLER	Outer guide TRACK ROLLER	Double guide TRACK ROLLER
 <p>NUT MOUNTED</p>	 <p>NUT MOUNTED</p>	 <p>NUT MOUNTED</p>
 <p>BOLT MOUNTED</p>	 <p>BOLT MOUNTED</p>	 <p>BOLT MOUNTED</p>
 <p>BRACKET MOUNTED</p>	 <p>BRACKET MOUNTED</p>	 <p>BRACKET MOUNTED</p>
 <p>SHAFT MOUNTED</p>	 <p>SHAFT MOUNTED</p>	 <p>SHAFT MOUNTED</p>

SPROCKETS

SPROCKET with offset bolted	DRIVE SPROCKET with offset keyed	SPROCKET with splined gear	SPROCKET segment
			



TOP ROLLERS

TOP ROLLER	Inner guide TOP ROLLER	Outer guide TOP ROLLER
 <p data-bbox="295 645 470 676">NUT MOUNTED</p>		
 <p data-bbox="268 1019 497 1050">BRACKET MOUNTED</p>	 <p data-bbox="758 1019 989 1050">BRACKET MOUNTED</p>	
 <p data-bbox="284 1393 485 1424">SHAFT MOUNTED</p>	 <p data-bbox="774 1393 975 1424">SHAFT MOUNTED</p>	 <p data-bbox="1189 1393 1390 1424">SHAFT MOUNTED</p>

IDLER

IDLER	IDLER
	



NICE TO KNOW

Engine parts

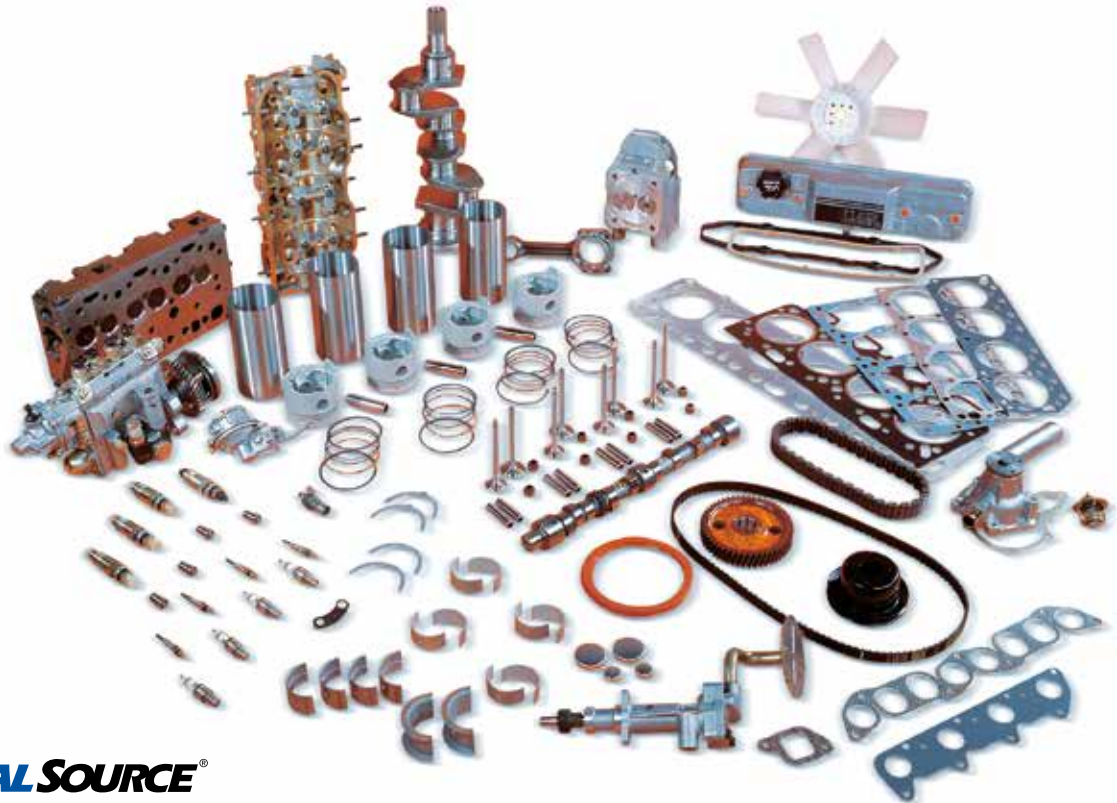

TOTALSOURCE®

Suitable for:

Caterpillar · Continental · Cummins · Deutz · Fiat · Ford · GM · Hatz · Isuzu · JCB · Kubota · Lombardini · Mazda · Mercedes · Mitsubishi · Perkins · Scania · Vanguard · Volvo · VW · Wisconsin · Yanmar · ...

TVH also has a wide range of reconditioned engine parts in stock, such as cylinder heads, engine blocks, crankshafts ...

Go to downloads on www.tvh.com or order your copy of the Engine parts catalogue (REF 34167446).



REF 34167446





NICE TO KNOW

Telehandlers, rough terrain forklifts & small earth-moving

Does your fleet include any telehandlers, rough terrain forklifts & small earth-moving? Then this Telehandlers, rough terrain forklifts & small earth-moving catalogue will be the ideal tool in your search for the right part. In this catalogue you can find an overview of seats, lights, mirrors, paint and so much more. This catalogue is available in 4 languages.

Go to downloads on www.tvh.com or order your copy of this catalogue.

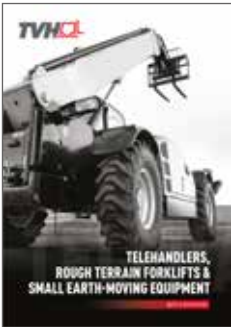

- REF 33103995 - English
- REF 33362021 - French
- REF 34028284 - German
- REF 34242326 - Dutch



Windshields & glazing

TVH has an extensive range of windshields, glazing and accessories for your telehandlers, rough-terrain forklifts, mini-excavators and skid steer loaders. In this product special we have collected all references by brand so that you can easily find the reference you are looking for.

Go to downloads on www.tvh.com or order your copy of the Windshields & glazing catalogue (REF 34609026).



REF 34609026



Go to downloads on www.tvh.com or order your copy of the Windshields & glazing special (REF 21497051).



REF 21497051





NICE TO KNOW

MyTotalSource

Your interactive online webshop for spare parts



The user-friendly search modules **MyPartsFinder** (search by brand and truck type) and **MyProductSearch** (search by specifications/technical info) allow you to always find the correct part!

Dimensions shown in this catalogue are standard dimensions. Measured dimensions may vary slightly.

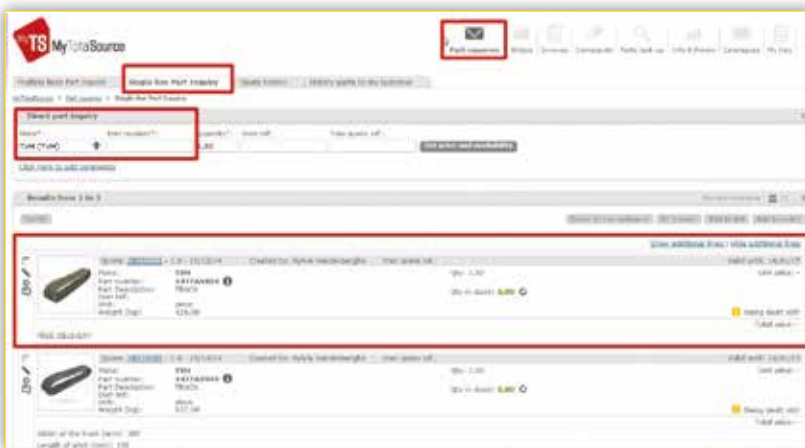

- **Single line part inquiry:** for a quick price and lead time of only 1 item
- **Multiple line part inquiry:** for price and lead time of several parts
- Instant price, availability and picture



The references in the catalogue only contain the most important info, but once the ref is entered via MTS, then extra info can be consulted such as:

- Extra technical info
- Larger (and more specific) photographs

No login yet? Request your login details now via ecommerce@tvh.com

HELPDESK: T +32 56 43 48 66



NICE TO KNOW

MyTotalSource

Your interactive online webshop for spare parts



The user-friendly search modules **MyPartsFinder** (search by brand and truck type) and **MyProductSearch** (search by specifications/technical info) allow you to always find the correct part!

Dimensions shown in this catalogue are standard dimensions. Measured dimensions may vary slightly.

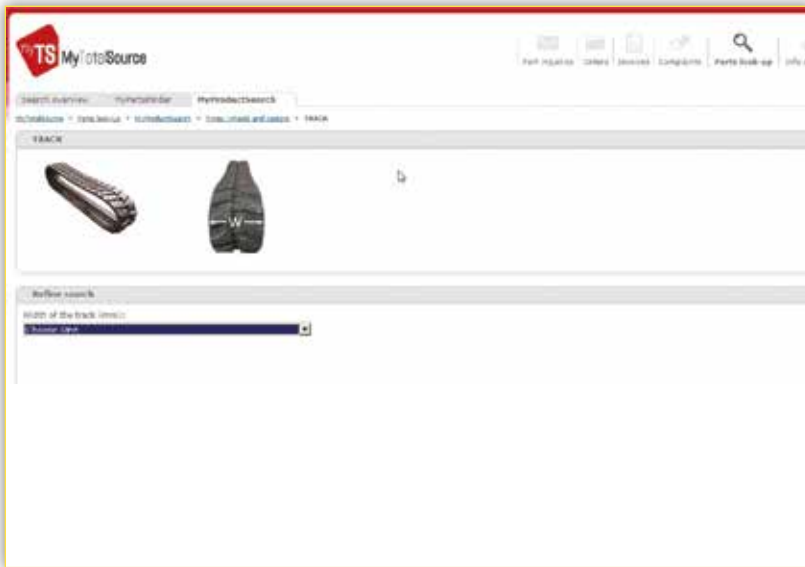

MyProductSearch
Find your consumables group

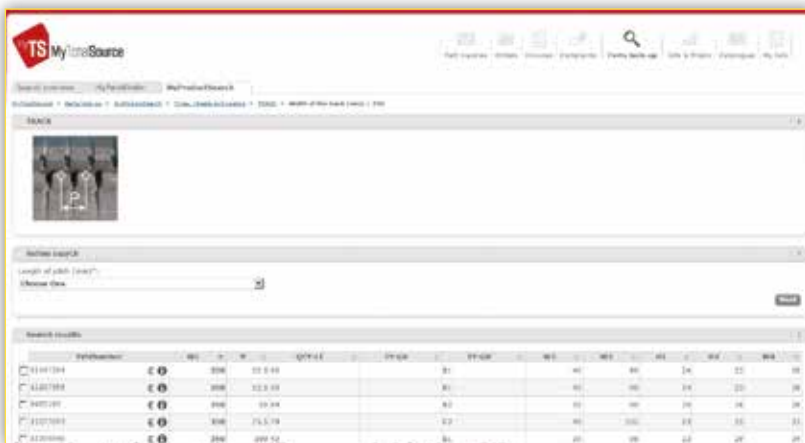

It is also possible to search further via MPS (MyProductSearch) for a similar part with other characteristics if necessary, or the parts can also be compared to each other.

No login yet? Request your login details now via ecommerce@tvh.com

HELPDESK: T +32 56 43 48 66



TECHNICAL SHEET

TECHNICAL SHEET
TRACKS

Group
16-01-05-00



Customer details

Type machine: Price inquiry
 Serial n° machine: Order

CODE: W1 x P x QTY-LI x TY-GS x TY-GU x W2 x W3 x H1 x H2 x W4



- W1 Width (mm).
- P Pitch length (mm).
- QTY-LI Quantity of links.
- TY-GS Type of guiding system.
- TY-GU Type of guiding.
- W2 Width between links (mm).
- W3 Width over links (mm).
- H1 Height 1 (mm).
- H2 Height 2 (mm).
- W4 Width 4 (mm).



TECHNICAL SHEET

Track size identification

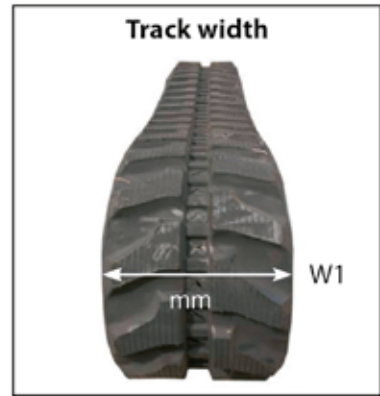
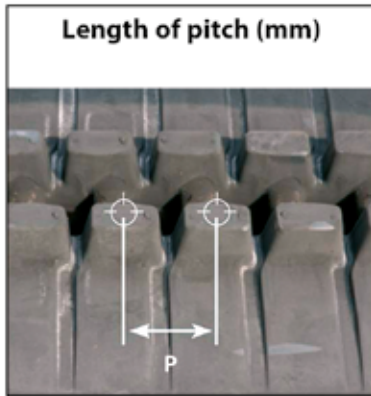

TYPES

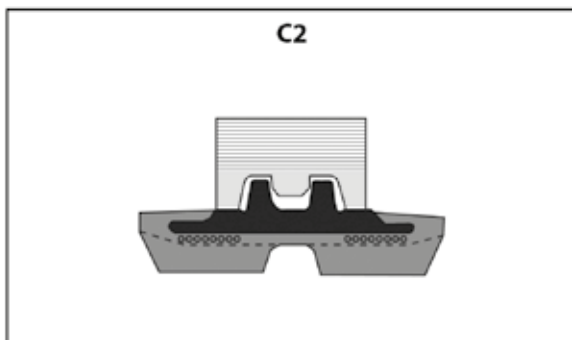
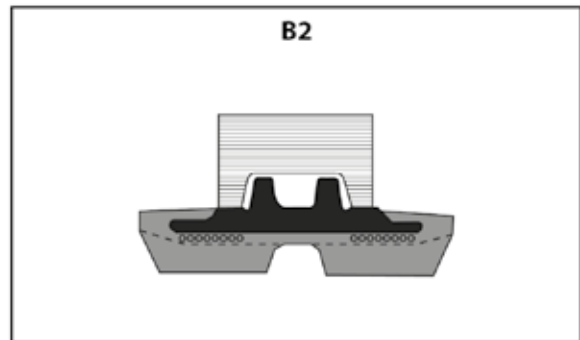
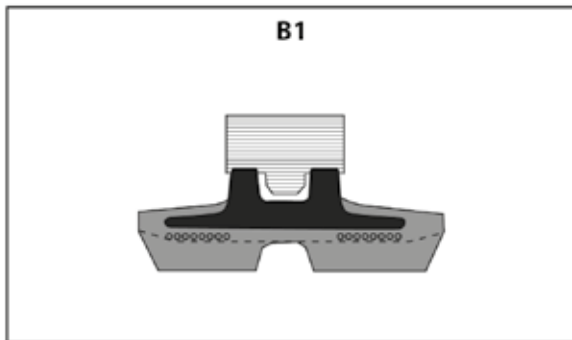
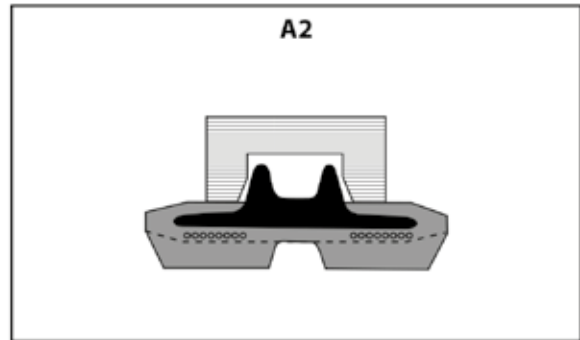
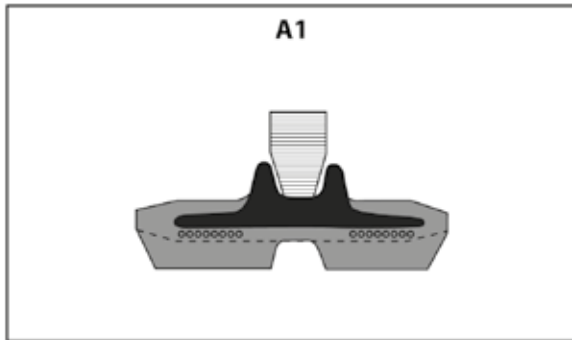



DIMENSIONS

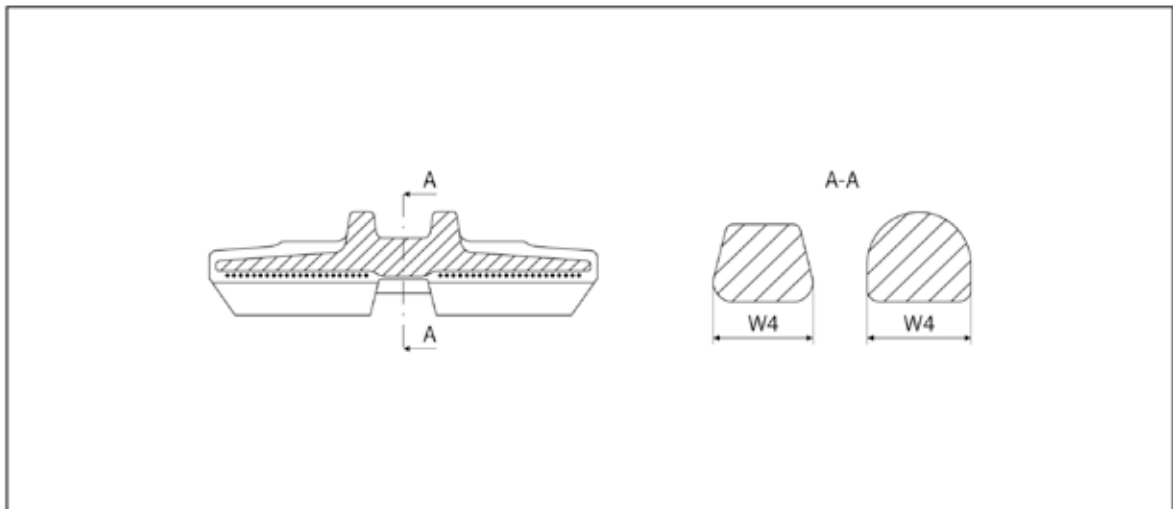
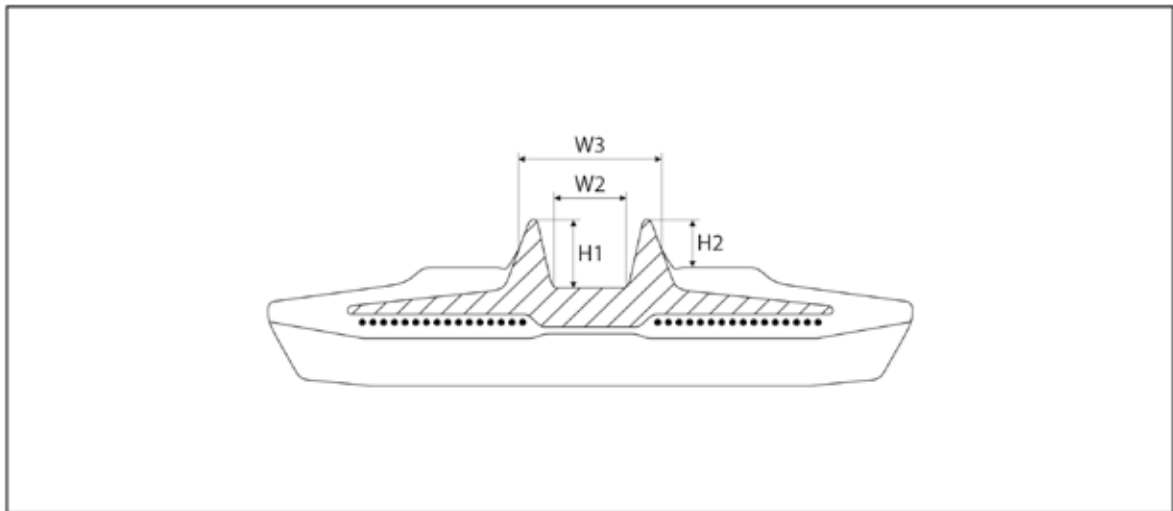
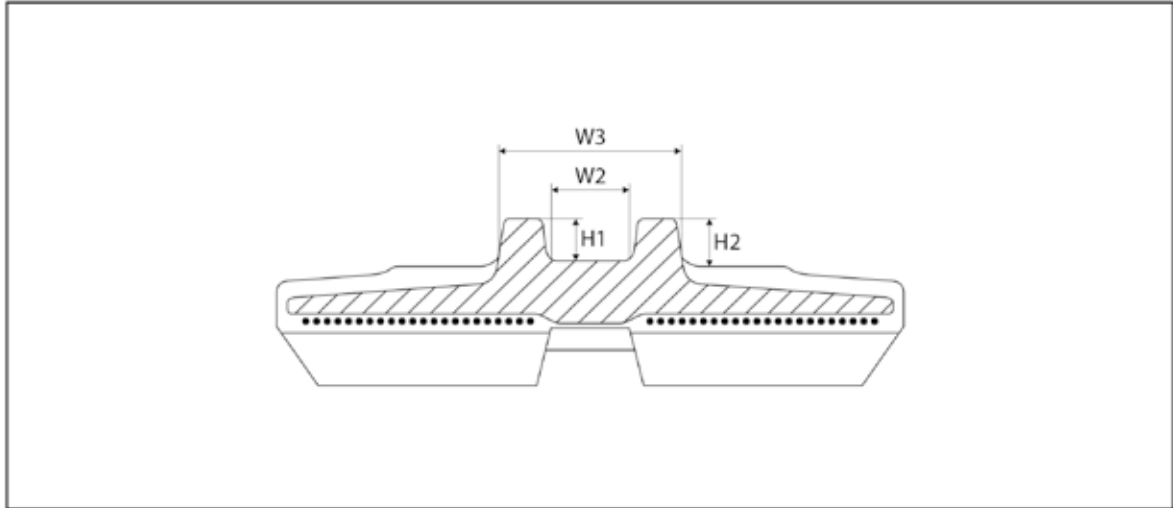



TECHNICAL SHEET

TECHNISCHE FICHE

RUPSBAND

Groep
16-01-05-00



Gegevens klant

Type machine: Prijsaanvraag
 Serienr. machine: Bestelling

CODE: W1 x P x QTY-LI x TY-GS x TY-GU x W2 x W3 x H1 x H2 x W4



- W1 Breedte (mm).
- P..... Pitch lengte (mm).
- QTY-LI..... Aantal schakels.
- TY-GS Type geleidingsystem.
- TY-GU..... Type geleiding.
- W2..... Breedte tussen de schakels (mm).
- W3..... Breedte over de schakels (mm).
- H1 Hoogte 1 (mm).
- H2 Hoogte 2 (mm).
- W4..... Breedte 4 (mm).



TECHNICAL SHEET

FICHE TECHNIQUE
CHENILLES EN CAOUTCHOUC

Groupe
16-01-05-00



Données client

Type machine : Demande de prix
No. série machine : Commande

CODE : W1 x P x QTY-LI x TY-GS x TY-GU x W2 x W3 x H1 x H2 x W4



- W1 Largeur (mm).
- P Longueur du pas (mm).
- QTY-LI Nombre de maillons.
- TY-GS Type de système de guidage.
- TY-GU Type de guidage.
- W2 Largeur entre les dents (mm).
- W3 Largeur hors les dents (mm).
- H1 Hauteur 1 (mm).
- H2 Hauteur 2 (mm).
- W4 Largeur 4 (mm).



TECHNICAL SHEET

TECHNISCHES DATENBLATT GUMMILAUFKETTEN

Gruppe
16-01-05-00



Kundendaten

Maschinentyp: Preisanfrage
 Serien-Nr. Maschine: Bestellung

CODE: W1 x P x QTY-LI x TY-GS x TY-GU x W2 x W3 x H1 x H2 x W4



- W1 Breite (Mm).
- P Schalmenlänge (Mm).
- QTY-LI Anzahl Glieder.
- TY-GS Art vom Führungssystem.
- TY-GU Art der Führung.
- W2 Breite zwischen den Gliedern (Mm).
- W3 Breite über die Glieder (Mm).
- H1 Höhe 1 (Mm).
- H2 Höhe 2 (Mm).
- W4 Breite 4 (Mm).



TECHNICAL SHEET

RUBBER PADS

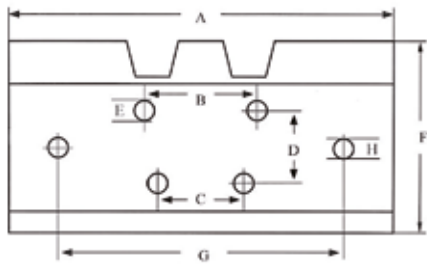

Single grouser plate size*

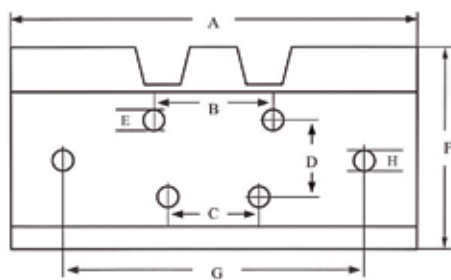

Double grouser plate size*

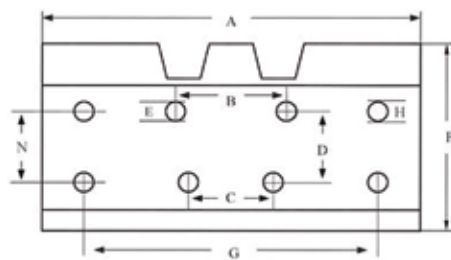

Triple grouser plate size*

* Choose your specific execution. Tick where necessary.

Machine type:

Model:

Number of links:

A:

F:

K:

B:

G:

L:

C:

H:

M:

D:

I:

N:

E:

J:

O:



USED FOR
AICHI



used for AICHI

used for AICHI				
TRACK ROLLER	TOP ROLLER	SPROCKET	IDLER	TRACK
				
AICHI SR123				
REF 144TA1949 (for steel tracks) (Ø flange = 158,00 mm) (Ø body = 132,00 mm)	REF 143TA8942 (assembly) (for steel tracks) (Ø body = 70,00 mm)	REF 143TA9010 (for steel tracks) (number of teeth = 23) (number of holes = 12)	REF 143TA9274 (for steel tracks)	
AICHI SR12B				
REF 143TA8849 (for steel tracks) (frame) (Ø flange = 134,00 mm) (Ø body = 100,00 mm)	REF 143TA8944 (assembly) (for steel tracks) (Ø body = 70,00 mm)	REF 143TA9011 (for steel tracks) (number of teeth = 19) (number of holes = 9)	REF 143TA9565 (for steel tracks) (LH) (Ø = 380,00 mm)	
REF 143TA8869 (for steel tracks) (bracket) (Ø flange = 134,20 mm) (Ø body = 100,00 mm)			REF 143TA9564 (for steel tracks) (RH)	
AICHI SR12BJ				
REF 143TA8849 (for steel tracks) (frame) (Ø flange = 134,00 mm) (Ø body = 100,00 mm)	REF 143TA8888 (for steel tracks) (Ø body = 76,00 mm)	REF 143TA9011 (for steel tracks) (number of teeth = 19) (number of holes = 9)	REF 143TA9565 (for steel tracks) (LH) (Ø = 380,00 mm)	
REF 143TA8869 (for steel tracks) (bracket) (Ø flange = 134,20 mm) (Ø body = 100,00 mm)			REF 143TA9564 (for steel tracks) (RH)	
AICHI SR12C				
REF 144TA1948 (for steel tracks) (bracket)	REF 143TA8888 (for steel tracks) (Ø body = 76,00 mm)	REF 143TA9011 (for steel tracks) (number of teeth = 19) (number of holes = 9)	REF 143TA9565 (for steel tracks) (LH) (Ø = 380,00 mm)	
REF 143TA8850 (for steel tracks) (frame) (Ø flange = 134,00 mm) (Ø body = 100,00 mm)			REF 143TA9564 (for steel tracks) (RH)	
AICHI SR14C				
REF 144TA1948 (for steel tracks) (bracket)	REF 143TA8888 (for steel tracks) (Ø body = 76,00 mm)	REF 143TA9011 (for steel tracks) (number of teeth = 19) (number of holes = 9)	REF 143TA9564 (for steel tracks) (RH)	
REF 143TA8850 (for steel tracks) (frame) (Ø flange = 134,00 mm) (Ø body = 100,00 mm)			REF 143TA9565 (for steel tracks) (LH) (Ø = 380,00 mm)	
AICHI SR14CJ				
REF 144TA1948 (for steel tracks) (bracket)	REF 143TA8888 (for steel tracks) (Ø body = 76,00 mm)	REF 143TA9011 (for steel tracks) (number of teeth = 19) (number of holes = 9)	REF 143TA9564 (for steel tracks) (RH)	
REF 143TA8850 (for steel tracks) (frame) (Ø flange = 134,00 mm) (Ø body = 100,00 mm)			REF 143TA9565 (for steel tracks) (LH) (Ø = 380,00 mm)	
AICHI SR182				
REF 144TA1945 (for steel tracks) (Ø flange = 164,50 mm) (Ø body = 136,00 mm)	REF 143TA8889 (for steel tracks) (Ø body = 116,00 mm)	REF 143TA9012 (for steel tracks)	REF 143TA9275 (for steel tracks) (Ø = 515,00 mm)	
AICHI SR18A				
REF 144TA1945 (for steel tracks) (Ø flange = 164,50 mm) (Ø body = 136,00 mm)	REF 143TA8889 (for steel tracks) (Ø body = 116,00 mm)	REF 144TA1947 (for steel tracks) (number of teeth = 21) (number of holes = 15)	REF 143TA9275 (for steel tracks) (Ø = 515,00 mm)	







used for AICHI				
TRACK ROLLER	TOP ROLLER	SPROCKET	IDLER	TRACK
				
AICHI SR18AJ				
REF 144TA1945 (for steel tracks) (Ø flange = 164,50 mm) (Ø body = 136,00 mm)	REF 143TA8889 (for steel tracks) (Ø body = 116,00 mm)	REF 144TA1947 (for steel tracks) (number of teeth = 21) (number of holes = 15)	REF 143TA9275 (for steel tracks) (Ø = 515,00 mm)	
AICHI SR210				
REF 144TA1945 (for steel tracks) (Ø flange = 164,50 mm) (Ø body = 136,00 mm)	REF 143TA8889 (for steel tracks) (Ø body = 116,00 mm)	REF 143TA9012 (for steel tracks)	REF 143TA9275 (for steel tracks) (Ø = 515,00 mm)	
AICHI SR21A				
REF 144TA1945 (for steel tracks) (Ø flange = 164,50 mm) (Ø body = 136,00 mm)	REF 143TA8889 (for steel tracks) (Ø body = 116,00 mm)	REF 144TA1947 (for steel tracks) (number of teeth = 21) (number of holes = 15)	REF 143TA9275 (for steel tracks) (Ø = 515,00 mm)	
AICHI SR21AJ				
REF 144TA1945 (for steel tracks) (Ø flange = 164,50 mm) (Ø body = 136,00 mm)	REF 143TA8889 (for steel tracks) (Ø body = 116,00 mm)	REF 144TA1947 (for steel tracks) (number of teeth = 21) (number of holes = 15)	REF 143TA9275 (for steel tracks) (Ø = 515,00 mm)	



USED FOR
AIRMAN



used for AIRMAN

used for AIRMAN				
TRACK ROLLER	TOP ROLLER	SPROCKET	IDLER	TRACK
				
AIRMAN AX 16				
				REF 164TA9682 (rubber) (230 x 48 x 66)
AIRMAN AX 25-1				
				REF 143TA9605 (rubber) (300 x 55 x 74)
AIRMAN AX 25-2				
				REF 143TA9605 (rubber) (300 x 55 x 74)
AIRMAN AX 25-3				
		REF 144TA9741 (for rubber tracks)		REF 143TA9606 (rubber) (250 x 52,5 x 73)
AIRMAN AX 30				
REF 144TA1774 (for rubber tracks) (Ø flange = 108,00 mm) (Ø body = 85,00 mm)	REF 144TA9738 (assembly) (for rubber tracks) (Ø body = 80,00 mm)	REF 144TA1785 (for rubber tracks)	REF 144TA9739 (for rubber tracks) (Ø = 307,00 mm)	REF 143TA9607 (rubber) (300 x 52,5 x 82)
AIRMAN AX 35				
REF 144TA1774 (for rubber tracks) (Ø flange = 108,00 mm) (Ø body = 85,00 mm)	REF 144TA9738 (assembly) (for rubber tracks) (Ø body = 80,00 mm)	REF 144TA1785 (for rubber tracks)	REF 144TA9739 (for rubber tracks) (Ø = 307,00 mm)	REF 143TA9608 (rubber) (300 x 55 x 80)
AIRMAN HM 35				
REF 144TA9740 (for rubber tracks)				REF 139TA9439 (rubber) (300 x 109 x 42)



USED FOR
ATLAS



used for ATLAS

used for ATLAS				
TRACK ROLLER	TOP ROLLER	SPROCKET	IDLER	TRACK
				
ATLAS 605 R				
<p>REF 144TA9742 (for rubber tracks) (Ø flange = 140,00 mm) (Ø body = 110,00 mm)</p> <p>REF 144TA9744 (for steel tracks) (Ø flange = 140,00 mm) (Ø body = 110,00 mm)</p>		<p>REF 144TA1799 (for rubber tracks) (number of teeth = 19) (number of holes = 9)</p> <p>REF 144TA9745 (for steel tracks) (number of teeth = 19) (number of holes = 9)</p>	<p>REF 144TA9743 (wheel only) (for rubber tracks) (Ø = 376,50 mm)</p> <p>REF 144TA9746 (wheel only) (for steel tracks) (Ø = 376,50 mm)</p>	<p>REF 164TA9675 (rubber) (400 x 72,5 x 76)</p>
ATLAS 805 R				
<p>REF 144TA9747 (for rubber tracks) (Ø flange = 155,00 mm) (Ø body = 121,00 mm)</p> <p>REF 144TA9750 (for steel tracks) (Ø flange = 155,00 mm) (Ø body = 121,00 mm)</p>		<p>REF 144TA9748 (for rubber tracks) (number of teeth = 23) (number of holes = 16) (total height = 38,00)</p> <p>REF 144TA9751 (for steel tracks)</p>	<p>REF 144TA9749 (wheel only) (for rubber tracks)</p> <p>REF 144TA9752 (wheel only) (for steel tracks)</p>	<p>REF 143TA9611 (rubber) (450 x 71 x 86)</p>
ATLAS AM 35 R				
<p>REF 144TA9753 (for rubber tracks) (Ø flange = 133,00 mm) (Ø body = 95,00 mm)</p> <p>REF 144TA9756 (for steel tracks) (Ø flange = 115,00 mm) (Ø body = 95,00 mm)</p>		<p>REF 144TA9754 (for rubber tracks) (number of teeth = 21) (number of holes = 12) (total height = 26,00 mm)</p> <p>REF 144TA9757 (for steel tracks) (number of teeth = 21) (number of holes = 12) (total height = 26,00 mm)</p>	<p>REF 144TA9755 (wheel only) (for rubber tracks) (Ø = 311,00 mm)</p> <p>REF 144TA9758 (wheel only) (for steel tracks)</p>	<p>REF 164TA9678 (rubber) (300 x 55 x 78)</p>
ATLAS AM 37 R				
<p>REF 144TA9759 (for rubber tracks) (Ø flange = 133,00 mm) (Ø body = 95,00 mm)</p> <p>REF 144TA9762 (for steel tracks) (Ø flange = 115,00 mm) (Ø body = 95,00 mm)</p>		<p>REF 144TA9760 (for rubber tracks) (number of teeth = 21) (number of holes = 12) (total height = 26,00 mm)</p> <p>REF 144TA9763 (for steel tracks) (number of teeth = 21) (number of holes = 12) (total height = 26,00 mm)</p>	<p>REF 144TA9761 (wheel only) (for rubber tracks) (Ø = 311,00 mm)</p>	<p>REF 164TA9680 (rubber) (300 x 52,5 x 86)</p>



USED FOR
BOBCAT







used for BOBCAT				
TRACK ROLLER	TOP ROLLER	SPROCKET	IDLER	TRACK
				
BOBCAT 100				
<i>S/P: 5049 - S/N: 11001 - 11999</i>				
REF 144TA2395 (for chassis sn 6001 until 6514)		REF 144TA2545	REF 144TA2393 (for chassis sn 6001 until 8418)	
REF 144TA2547 (for chassis sn 6515 until 8418)			REF 144TA2422 (for chassis sn 8419 and up)	
REF 144TA2548 (for chassis sn 8419 and up) (Ø flange = 145,00 mm) (Ø body = 85,00 mm)				
<i>S/P: 5049 - S/N: 12001 - and up</i>				
REF 144TA2394		REF 144TA2441	REF 144TA2444 (for chassis sn 13025 and up)	
			REF 144TA2550 (for chassis sn 10001 until 13024)	
BOBCAT 116				
<i>S/P: 5050 - S/N: 11001 - 11999</i>				
REF 144TA2378		REF 144TA2377	REF 144TA2422	
<i>S/P: 5050 - S/N: 12001 - and up</i>				
REF 144TA2435		REF 144TA2559 (for chassis sn 11900 and up)	REF 144TA2422 (for chassis sn 12141 and up)	
REF 144TA2558 (for swamp shoe)		REF 144TA2377 (for chassis sn 11044 until 11899)	REF 144TA2554 (for chassis sn 10001 until 12140)	
		REF 144TA2560 (for chassis sn 10001 until 11043)		
BOBCAT 130				
<i>S/P: 5051 - S/N: 11001 - 11999</i>				
REF 144TA2370	REF 144TA2376	REF 144TA2368	REF 144TA2369	
BOBCAT 220				
<i>S/P: 5082 - S/N: 11001 - 11999</i>				
REF 144TA2339 (Ø flange = 130,00 mm) (Ø body = 72,00 mm)		REF 143TA9038 (number of teeth = 14) (number of holes = 9)	REF 144TA2280 (Ø = 290,00 mm)	REF 164TA3079 (230 x 72 x 45)
<i>S/P: 5082 - S/N: 12001 - 12929</i>				
REF 144TA2339 (Ø flange = 130,00 mm) (Ø body = 72,00 mm)		REF 144TA2210	REF 144TA2280 (Ø = 290,00 mm)	REF 164TA3079 (230 x 72 x 45)
<i>S/P: 5082 - S/N: 12930 - and up</i>				
REF 144TA2339 (Ø flange = 130,00 mm) (Ø body = 72,00 mm)		REF 143TA9038 (number of teeth = 14) (number of holes = 9)	REF 144TA2280 (Ø = 290,00 mm)	REF 164TA3079 (230 x 72 x 45)
BOBCAT 225				
<i>S/P: 5083 - S/N: 11001 - and up</i>				
REF 144TA2198 (inner guide roller) (Ø flange = 115,00 mm) (Ø body = 95,00 mm)		REF 144TA2206 (number of teeth = 12) (number of holes = 9)	REF 144TA2199 (Ø = 295,00 mm)	REF 164TA1547 (320 x 52,5 x 74)
REF 144TA2208 (outer guide roller) (Ø flange = 140,00 mm) (Ø body = 68,00 mm)		REF 144TA2225 (number of teeth = 21) (number of holes = 9)	REF 144TA2207 (Ø = 337,00 mm)	REF 164TA1546 (320 x 100 x 40)



used for BOBCAT				
TRACK ROLLER	TOP ROLLER	SPROCKET	IDLER	TRACK
				
REF 144TA2349 (inner guide roller) (Ø flange = 133,00 mm) (Ø body = 95,00 mm)			REF 144TA2230 (Ø = 311,00 mm)	REF 164TA3069 (320 x 52,5 x 74)
BOBCAT 231				
<i>S/P: 5089 - S/N: 11001 - and up</i>				
REF 144TA2249 (inner guide) (nut mounted) (Ø flange = 115,00 mm) (Ø body = 95,00 mm)		REF 144TA2213 (number of teeth = 21) (number of holes = 9)	REF 144TA2230 (Ø = 311,00 mm)	REF 164TA1409 (300 x 52,5 x 80)
REF 144TA2204 (inner guide) (nut mounted) (Ø flange = 133,00 mm) (Ø body = 95,00 mm)			REF 144TA2199 (Ø = 295,00 mm)	
REF 144TA2458 (for rubber tracks) (bolt mounted) (Ø flange = 130,00 mm) (Ø body = 95,50 mm)				
REF 144TA2457 (for steel tracks) (bolt mounted)				
BOBCAT 316				
<i>S/P: 5228 - S/N: 11001 - and up</i>				
REF 144TA2498		REF 144TA2293	REF 144TA2294	REF 144TA2300 (180 x 72 x 38)
<i>S/P: 5229 - S/N: 11001 - and up</i>				
REF 144TA2498		REF 144TA2293	REF 144TA2294	REF 144TA2300 (180 x 72 x 38)
BOBCAT 319				
<i>S/P: 5633 - S/N: 11001 - and up</i>				
REF 144TA2326 (Ø flange = 130,00 mm) (Ø body = 72,00 mm)		REF 143TA9023 (number of teeth = 13) (number of holes = 9)	REF 144TA2221 (Ø = 270,00 mm)	REF 143TA9623 (200 x 72 x 41)
BOBCAT 320				
<i>S/P: 2235 - S/N: 11001 - and up</i>				
REF 144TA2348 (for rubber tracks) (bolt mounted) (Ø flange = 115,00 mm) (Ø body = 80,00 mm)		REF 144TA2302 (number of teeth = 19) (number of holes = 9)	REF 144TA2240 (for rubber tracks) (Ø = 263,00 mm)	REF 143TA9652 (230 x 96 x 33)
REF 144TA2477 (for steel tracks) (bolt mounted)			REF 144TA2242 (for steel tracks) (Ø = 247,00 mm)	
<i>S/P: 2238 - S/N: 11001 - and up</i>				
REF 144TA2348 (for rubber tracks) (bolt mounted) (Ø flange = 115,00 mm) (Ø body = 80,00 mm)		REF 144TA2302 (number of teeth = 19) (number of holes = 9)	REF 144TA2240 (for rubber tracks) (Ø = 263,00 mm)	REF 143TA9652 (230 x 96 x 33)
REF 144TA2477 (for steel tracks) (bolt mounted)			REF 144TA2242 (for steel tracks) (Ø = 247,00 mm)	
<i>S/P: 2239 - S/N: 11001 - and up</i>				
REF 144TA2348 (for rubber tracks) (bolt mounted) (Ø flange = 115,00 mm) (Ø body = 80,00 mm)		REF 144TA2302 (number of teeth = 19) (number of holes = 9)	REF 144TA2240 (for rubber tracks) (Ø = 263,00 mm)	REF 143TA9652 (230 x 96 x 33)
REF 144TA2477 (for steel tracks) (bolt mounted)			REF 144TA2242 (for steel tracks) (Ø = 247,00 mm)	
<i>S/P: 2240 - S/N: 11001 - and up</i>				
REF 144TA2348 (for rubber tracks) (bolt mounted) (Ø flange = 115,00 mm) (Ø body = 80,00 mm)		REF 144TA2302 (number of teeth = 19) (number of holes = 9)	REF 144TA2240 (for rubber tracks) (Ø = 263,00 mm)	REF 143TA9652 (230 x 96 x 33)



used for BOBCAT				
TRACK ROLLER	TOP ROLLER	SPROCKET	IDLER	TRACK
				
REF 144TA2477 (for steel tracks) (bolt mounted)			REF 144TA2242 (for steel tracks) (Ø = 247,00 mm)	
<i>S/P: 2245 - S/N: 11001 - and up</i>				
REF 144TA2241 (for rubber tracks) (nut mounted) (Ø flange = 115,00 mm) (Ø body = 80,00 mm)		REF 144TA2302 (number of teeth = 19) (number of holes = 9)	REF 144TA2240 (for rubber tracks) (Ø = 263,00 mm)	REF 143TA9652 (230 x 96 x 33)
REF 144TA2244 (for steel tracks) (nut mounted) (Ø flange = 115,00 mm) (Ø body = 80,00 mm)			REF 144TA2242 (for steel tracks) (Ø = 247,00 mm)	
REF 144TA2348 (for rubber tracks) (bolt mounted) (Ø flange = 115,00 mm) (Ø body = 80,00 mm)				
REF 144TA2477 (for steel tracks) (bolt mounted)				
<i>S/P: 5117 - S/N: 20001 - and up</i>				
REF 144TA2212 (Ø flange = 130,00 mm) (Ø body = 72,00 mm)		REF 143TA9038 (number of teeth = 14) (number of holes = 9)	REF 144TA2280 (Ø = 290,00 mm)	REF 143TA9652 (230 x 96 x 33)
<i>S/P: 5178 - S/N: 11001 - and up</i>				
REF 144TA2306 (Ø flange = 115,00 mm) (Ø body = 80,00 mm)		REF 144TA2302 (number of teeth = 19) (number of holes = 9)	REF 144TA2408 (Ø = 263,00 mm)	REF 143TA9652 (230 x 96 x 33)
<i>S/P: 5623 - S/N: 13001 - 19999</i>				
REF 144TA2212 (Ø flange = 130,00 mm) (Ø body = 72,00 mm)		REF 143TA9038 (number of teeth = 14) (number of holes = 9)	REF 144TA2280 (Ø = 290,00 mm)	REF 143TA9652 (230 x 96 x 33)
<i>S/P: 5623 - S/N: 20001 - and up</i>				
REF 144TA2306 (Ø flange = 115,00 mm) (Ø body = 80,00 mm)		REF 144TA2302 (number of teeth = 19) (number of holes = 9)	REF 144TA2408 (Ø = 263,00 mm)	REF 143TA9652 (230 x 96 x 33)
<i>S/P: 5624 - S/N: 11001 - and up</i>				
REF 144TA2241 (for rubber tracks) (nut mounted) (Ø flange = 115,00 mm) (Ø body = 80,00 mm)		REF 144TA2302 (number of teeth = 19) (number of holes = 9)	REF 144TA2240 (for rubber tracks) (Ø = 263,00 mm)	REF 143TA9652 (230 x 96 x 33)
REF 144TA2244 (for steel tracks) (nut mounted) (Ø flange = 115,00 mm) (Ø body = 80,00 mm)			REF 144TA2242 (for steel tracks) (Ø = 247,00 mm)	
REF 144TA2348 (for rubber tracks) (bolt mounted) (Ø flange = 115,00 mm) (Ø body = 80,00 mm)				
REF 144TA2477 (for steel tracks) (bolt mounted)				
BOBCAT 321				
<i>S/P: A017 - S/N: 11001 - 12428</i>				
REF 144TA2348 (Ø flange = 115,00 mm) (Ø body = 80,00 mm)		REF 144TA2476 (number of teeth = 19) (number of holes = 9)	REF 144TA2240 (Ø = 263,00 mm)	REF 143TA9652 (230 x 96 x 33)
<i>S/P: A017 - S/N: 12429 - and up</i>				
REF 144TA2348 (Ø flange = 115,00 mm) (Ø body = 80,00 mm)		REF 144TA2476 (number of teeth = 19) (number of holes = 9)	REF 144TA2470 (Ø = 265,00 mm)	REF 143TA9652 (230 x 96 x 33)



used for BOBCAT				
TRACK ROLLER	TOP ROLLER	SPROCKET	IDLER	TRACK
				
<i>S/P: A765 - S/N: 11001 - 11266</i>				
REF 144TA2348 (Ø flange = 115,00 mm) (Ø body = 80,00 mm)		REF 144TA2476 (number of teeth = 19) (number of holes = 9)	REF 144TA2240 (Ø = 263,00 mm)	REF 143TA9652 (230 x 96 x 33)
<i>S/P: A765 - S/N: 11267 - and up</i>				
REF 144TA2348 (Ø flange = 115,00 mm) (Ø body = 80,00 mm)		REF 144TA2476 (number of teeth = 19) (number of holes = 9)	REF 144TA2470 (Ø = 265,00 mm)	REF 143TA9652 (230 x 96 x 33)
BOBCAT 322				
<i>S/P: 2235 - S/N: 11001 - and up</i>				
REF 144TA2348 (for rubber tracks) (bolt mounted) (Ø flange = 115,00 mm) (Ø body = 80,00 mm)		REF 144TA2302 (number of teeth = 19) (number of holes = 9)	REF 144TA2240 (for rubber tracks) (Ø = 263,00 mm)	REF 143TA9652 (230 x 96 x 33)
REF 144TA2477 (for steel tracks) (bolt mounted)			REF 144TA2242 (for steel tracks) (Ø = 247,00 mm)	
<i>S/P: 2238 - S/N: 11001 - and up</i>				
REF 144TA2348 (for rubber tracks) (bolt mounted) (Ø flange = 115,00 mm) (Ø body = 80,00 mm)		REF 144TA2302 (number of teeth = 19) (number of holes = 9)	REF 144TA2240 (for rubber tracks) (Ø = 263,00 mm)	REF 143TA9652 (230 x 96 x 33)
REF 144TA2477 (for steel tracks) (bolt mounted)			REF 144TA2242 (for steel tracks) (Ø = 247,00 mm)	
<i>S/P: 2239 - S/N: 11001 - and up</i>				
REF 144TA2348 (for rubber tracks) (bolt mounted) (Ø flange = 115,00 mm) (Ø body = 80,00 mm)		REF 144TA2302 (number of teeth = 19) (number of holes = 9)	REF 144TA2240 (for rubber tracks) (Ø = 263,00 mm)	REF 143TA9652 (230 x 96 x 33)
REF 144TA2477 (for steel tracks) (bolt mounted)			REF 144TA2242 (for steel tracks) (Ø = 247,00 mm)	
<i>S/P: 2240 - S/N: 11001 - and up</i>				
REF 144TA2348 (for rubber tracks) (bolt mounted) (Ø flange = 115,00 mm) (Ø body = 80,00 mm)		REF 144TA2302 (number of teeth = 19) (number of holes = 9)	REF 144TA2240 (for rubber tracks) (Ø = 263,00 mm)	REF 143TA9652 (230 x 96 x 33)
REF 144TA2477 (for steel tracks) (bolt mounted)			REF 144TA2242 (for steel tracks) (Ø = 247,00 mm)	
<i>S/P: 5178 - S/N: 11001 - and up</i>				
REF 144TA2306 (Ø flange = 115,00 mm) (Ø body = 80,00 mm)		REF 144TA2302 (number of teeth = 19) (number of holes = 9)	REF 144TA2408 (Ø = 263,00 mm)	REF 143TA9652 (230 x 96 x 33)
<i>S/P: 5623 - S/N: 13001 - 19999</i>				
REF 144TA2212 (Ø flange = 130,00 mm) (Ø body = 72,00 mm)		REF 143TA9038 (number of teeth = 14) (number of holes = 9)	REF 144TA2280 (Ø = 290,00 mm)	REF 143TA9652 (230 x 96 x 33)
<i>S/P: 5623 - S/N: 20001 - and up</i>				
REF 144TA2306 (Ø flange = 115,00 mm) (Ø body = 80,00 mm)		REF 144TA2302 (number of teeth = 19) (number of holes = 9)	REF 144TA2408 (Ø = 263,00 mm)	REF 143TA9652 (230 x 96 x 33)
BOBCAT 323				
<i>S/P: 2245 - S/N: 11001 - and up</i>				
REF 144TA2241 (for rubber tracks) (nut mounted) (Ø flange = 115,00 mm) (Ø body = 80,00 mm)		REF 144TA2302 (number of teeth = 19) (number of holes = 9)	REF 144TA2240 (for rubber tracks) (Ø = 263,00 mm)	REF 143TA9652 (230 x 96 x 33)





TRACKS & UNDERCARRIAGE PARTS



used for BOBCAT

used for BOBCAT				
TRACK ROLLER	TOP ROLLER	SPROCKET	IDLER	TRACK
				
<p>REF 144TA2244 (for steel tracks) (nut mounted) (Ø flange = 115,00 mm) (Ø body = 80,00 mm)</p> <p>REF 144TA2348 (for rubber tracks) (bolt mounted) (Ø flange = 115,00 mm) (Ø body = 80,00 mm)</p> <p>REF 144TA2477 (for steel tracks) (bolt mounted)</p> <p><i>S/P: 5624 - S/N: 11001 - and up</i></p>			<p>REF 144TA2242 (for steel tracks) (Ø = 247,00 mm)</p>	
<p>REF 144TA2241 (for rubber tracks) (nut mounted) (Ø flange = 115,00 mm) (Ø body = 80,00 mm)</p> <p>REF 144TA2244 (for steel tracks) (nut mounted) (Ø flange = 115,00 mm) (Ø body = 80,00 mm)</p> <p>REF 144TA2348 (for rubber tracks) (bolt mounted) (Ø flange = 115,00 mm) (Ø body = 80,00 mm)</p> <p>REF 144TA2477 (for steel tracks) (bolt mounted)</p> <p><i>S/P: A017 - S/N: 11001 - 12428</i></p>		<p>REF 144TA2302 (number of teeth = 19) (number of holes = 9)</p>	<p>REF 144TA2240 (for rubber tracks) (Ø = 263,00 mm)</p> <p>REF 144TA2242 (for steel tracks) (Ø = 247,00 mm)</p>	<p>REF 143TA9652 (230 x 96 x 33)</p>
<p>REF 144TA2348 (Ø flange = 115,00 mm) (Ø body = 80,00 mm)</p> <p><i>S/P: A017 - S/N: 12429 - and up</i></p>		<p>REF 144TA2476 (number of teeth = 19) (number of holes = 9)</p>	<p>REF 144TA2240 (Ø = 263,00 mm)</p>	<p>REF 143TA9652 (230 x 96 x 33)</p>
<p>REF 144TA2348 (Ø flange = 115,00 mm) (Ø body = 80,00 mm)</p> <p><i>S/P: A765 - S/N: 11001 - 11266</i></p>		<p>REF 144TA2476 (number of teeth = 19) (number of holes = 9)</p>	<p>REF 144TA2470 (Ø = 265,00 mm)</p>	<p>REF 143TA9652 (230 x 96 x 33)</p>
<p>REF 144TA2348 (Ø flange = 115,00 mm) (Ø body = 80,00 mm)</p> <p><i>S/P: A765 - S/N: 11267 - and up</i></p>		<p>REF 144TA2476 (number of teeth = 19) (number of holes = 9)</p>	<p>REF 144TA2240 (Ø = 263,00 mm)</p>	<p>REF 143TA9652 (230 x 96 x 33)</p>
<p>REF 144TA2348 (Ø flange = 115,00 mm) (Ø body = 80,00 mm)</p> <p><i>S/P: A9JZ - S/N: 11001 - and up</i></p>		<p>REF 144TA2302 (number of teeth = 19) (number of holes = 9)</p>	<p>REF 144TA2240 (for rubber tracks) (Ø = 263,00 mm)</p> <p>REF 144TA2242 (for steel tracks) (Ø = 247,00 mm)</p>	<p>REF 143TA9652 (230 x 96 x 33)</p>
BOBCAT 324				
<i>S/P: AKY5 - S/N: 11001 - and up</i>				
<p>REF 144TA2348 (Ø flange = 115,00 mm) (Ø body = 80,00 mm)</p>		<p>REF 144TA2476 (number of teeth = 19) (number of holes = 9)</p>	<p>REF 144TA2470 (Ø = 265,00 mm)</p>	<p>REF 143TA9652 (230 x 96 x 33)</p>
BOBCAT 325				
<i>S/P: 2323 - S/N: 11001 - and up</i>				
<p>REF 144TA2407 (for steel tracks) (bolt mounted) (Ø flange = 115,00 mm) (Ø body = 95,00 mm)</p>		<p>REF 144TA2213 (number of teeth = 21) (number of holes = 9)</p>	<p>REF 144TA2495 (for rubber tracks) (Ø = 309,20 mm)</p>	<p>REF 143TA9654 (320 x 54 x 72)</p>



used for BOBCAT				
TRACK ROLLER	TOP ROLLER	SPROCKET	IDLER	TRACK
				
<p>REF 144TA2349 (for rubber tracks) (bolt mounted) (Ø flange = 133,00 mm) (Ø body = 95,00 mm)</p> <p>REF 144TA2204 (for rubber tracks) (nut mounted) (Ø flange = 133,00 mm) (Ø body = 95,00 mm)</p> <p>REF 144TA2249 (for steel tracks) (nut mounted) (Ø flange = 115,00 mm) (Ø body = 95,00 mm)</p> <p><i>S/P: 2324 - S/N: 11001 - and up</i></p>		<p>REF 144TA2325 (number of teeth = 21) (number of holes = 12)</p>	<p>REF 144TA2513 (for steel tracks) (Ø = 295,00 mm)</p>	
<p>REF 144TA2407 (for steel tracks) (bolt mounted) (Ø flange = 115,00 mm) (Ø body = 95,00 mm)</p> <p>REF 144TA2349 (for rubber tracks) (bolt mounted) (Ø flange = 133,00 mm) (Ø body = 95,00 mm)</p> <p>REF 144TA2204 (for rubber tracks) (nut mounted) (Ø flange = 133,00 mm) (Ø body = 95,00 mm)</p> <p>REF 144TA2249 (for steel tracks) (nut mounted) (Ø flange = 115,00 mm) (Ø body = 95,00 mm)</p> <p><i>S/P: 2341 - S/N: 11001 - and up</i></p>		<p>REF 144TA2213 (number of teeth = 21) (number of holes = 9)</p> <p>REF 144TA2325 (number of teeth = 21) (number of holes = 12)</p>	<p>REF 144TA2495 (for rubber tracks) (Ø = 309,20 mm)</p> <p>REF 144TA2513 (for steel tracks) (Ø = 295,00 mm)</p>	<p>REF 143TA9654 (320 x 54 x 72)</p>
<p>REF 144TA2349 (for rubber tracks) (bolt mounted) (Ø flange = 133,00 mm) (Ø body = 95,00 mm)</p> <p>REF 144TA2407 (for steel tracks) (bolt mounted) (Ø flange = 115,00 mm) (Ø body = 95,00 mm)</p> <p>REF 144TA2204 (for rubber tracks) (nut mounted) (Ø flange = 133,00 mm) (Ø body = 95,00 mm)</p> <p>REF 144TA2249 (for steel tracks) (nut mounted) (Ø flange = 115,00 mm) (Ø body = 95,00 mm)</p> <p><i>S/P: 2342 - S/N: 11001 - and up</i></p>		<p>REF 144TA2325 (number of teeth = 21) (number of holes = 12)</p>	<p>REF 144TA2495 (for rubber tracks) (Ø = 309,20 mm)</p> <p>REF 144TA2513 (for steel tracks) (Ø = 295,00 mm)</p>	<p>REF 143TA9654 (320 x 54 x 72)</p>
<p>REF 144TA2204 (for rubber tracks) (nut mounted) (Ø flange = 133,00 mm) (Ø body = 95,00 mm)</p> <p>REF 144TA2249 (for steel tracks) (nut mounted) (Ø flange = 115,00 mm) (Ø body = 95,00 mm)</p> <p>REF 144TA2349 (for rubber tracks) (bolt mounted) (Ø flange = 133,00 mm) (Ø body = 95,00 mm)</p> <p>REF 144TA2407 (for steel tracks) (bolt mounted) (Ø flange = 115,00 mm) (Ø body = 95,00 mm)</p> <p><i>S/P: 5118 - S/N: 20001 - 21999</i></p>		<p>REF 144TA2325 (number of teeth = 21) (number of holes = 12)</p>	<p>REF 144TA2513 (for steel tracks) (Ø = 295,00 mm)</p> <p>REF 144TA2495 (for rubber tracks) (Ø = 309,20 mm)</p>	<p>REF 143TA9654 (320 x 54 x 72)</p>
<p>REF 144TA2204 (for rubber tracks) (nut mounted) (Ø flange = 133,00 mm) (Ø body = 95,00 mm)</p> <p>REF 144TA2249 (for steel tracks) (nut mounted) (Ø flange = 115,00 mm) (Ø body = 95,00 mm)</p>		<p>REF 144TA2225 (number of teeth = 21) (number of holes = 9)</p>	<p>REF 144TA2207 (Ø = 337,00 mm)</p> <p>REF 144TA2230 (Ø = 311,00 mm)</p>	<p>REF 143TA9654 (320 x 54 x 72)</p>



used for BOBCAT				
TRACK ROLLER	TOP ROLLER	SPROCKET	IDLER	TRACK
				
<p>REF 144TA2349 (for rubber tracks) (bolt mounted) (Ø flange = 133,00 mm) (Ø body = 95,00 mm)</p> <p>REF 144TA2407 (for steel tracks) (bolt mounted) (Ø flange = 115,00 mm) (Ø body = 95,00 mm)</p> <p><i>S/P: 5140 - S/N: 11001 - 12999</i></p>			<p>REF 144TA2199 (Ø = 295,00 mm)</p>	
<p>REF 144TA2204 (for rubber tracks) (nut mounted) (Ø flange = 133,00 mm) (Ø body = 95,00 mm)</p> <p>REF 144TA2249 (for steel tracks) (nut mounted) (Ø flange = 115,00 mm) (Ø body = 95,00 mm)</p> <p>REF 144TA2349 (for rubber tracks) (bolt mounted) (Ø flange = 133,00 mm) (Ø body = 95,00 mm)</p> <p>REF 144TA2407 (for steel tracks) (bolt mounted) (Ø flange = 115,00 mm) (Ø body = 95,00 mm)</p> <p><i>S/P: 5140 - S/N: 13001 - and up</i></p>		<p>REF 144TA2225 (number of teeth = 21) (number of holes = 9) (Kayba motor)</p> <p>REF 144TA2213 (number of teeth = 21) (number of holes = 9) (Som motor)</p>	<p>REF 144TA2230 (Ø = 311,00 mm)</p> <p>REF 144TA2199 (Ø = 295,00 mm)</p>	<p>REF 143TA9654 (320 x 54 x 72)</p>
<p>REF 144TA2249 (for steel tracks) (nut mounted) (Ø flange = 115,00 mm) (Ø body = 95,00 mm)</p> <p>REF 144TA2407 (for steel tracks) (bolt mounted) (Ø flange = 115,00 mm) (Ø body = 95,00 mm)</p> <p>REF 144TA2349 (for rubber tracks) (bolt mounted) (Ø flange = 133,00 mm) (Ø body = 95,00 mm)</p> <p>REF 144TA2204 (for rubber tracks) (nut mounted) (Ø flange = 133,00 mm) (Ø body = 95,00 mm)</p> <p><i>S/P: 5166 - S/N: 11001 - and up</i></p>		<p>REF 144TA2213 (number of teeth = 21) (number of holes = 9)</p>	<p>REF 144TA2495 (for rubber tracks) (Ø = 309,20 mm)</p> <p>REF 144TA2513 (for steel tracks) (Ø = 295,00 mm)</p>	<p>REF 143TA9654 (320 x 54 x 72)</p>
<p>REF 144TA2407 (for steel tracks) (bolt mounted) (Ø flange = 115,00 mm) (Ø body = 95,00 mm)</p> <p>REF 144TA2349 (for rubber tracks) (bolt mounted) (Ø flange = 133,00 mm) (Ø body = 95,00 mm)</p> <p>REF 144TA2204 (for rubber tracks) (nut mounted) (Ø flange = 133,00 mm) (Ø body = 95,00 mm)</p> <p>REF 144TA2249 (for steel tracks) (nut mounted) (Ø flange = 115,00 mm) (Ø body = 95,00 mm)</p> <p><i>S/P: A9K0 - S/N: 11001 - and up</i></p>		<p>REF 144TA2213 (number of teeth = 21) (number of holes = 9)</p>	<p>REF 144TA2495 (for rubber tracks) (Ø = 309,20 mm)</p> <p>REF 144TA2513 (for steel tracks) (Ø = 295,00 mm)</p>	<p>REF 143TA9654 (320 x 54 x 72)</p>
<p>REF 144TA2204 (for rubber tracks) (nut mounted) (Ø flange = 133,00 mm) (Ø body = 95,00 mm)</p> <p>REF 144TA2249 (for steel tracks) (nut mounted) (Ø flange = 115,00 mm) (Ø body = 95,00 mm)</p>		<p>REF 144TA2325 (number of teeth = 21) (number of holes = 12)</p>	<p>REF 144TA2495 (for rubber tracks) (Ø = 309,20 mm)</p> <p>REF 144TA2513 (for steel tracks) (Ø = 295,00 mm)</p>	<p>REF 143TA9654 (320 x 54 x 72)</p>



used for BOBCAT				
TRACK ROLLER	TOP ROLLER	SPROCKET	IDLER	TRACK
				
<p>REF 144TA2349 (for rubber tracks) (bolt mounted) (Ø flange = 133,00 mm) (Ø body = 95,00 mm)</p> <p>REF 144TA2407 (for steel tracks) (bolt mounted) (Ø flange = 115,00 mm) (Ø body = 95,00 mm)</p> <p><i>S/P: A9K1 - S/N: 11001 - and up</i></p>				
<p>REF 144TA2204 (for rubber tracks) (nut mounted) (Ø flange = 133,00 mm) (Ø body = 95,00 mm)</p> <p>REF 144TA2249 (for steel tracks) (nut mounted) (Ø flange = 115,00 mm) (Ø body = 95,00 mm)</p> <p>REF 144TA2349 (for rubber tracks) (bolt mounted) (Ø flange = 133,00 mm) (Ø body = 95,00 mm)</p> <p>REF 144TA2407 (for steel tracks) (bolt mounted) (Ø flange = 115,00 mm) (Ø body = 95,00 mm)</p> <p><i>S/P: AAC5 - S/N: 11001 - and up</i></p>		<p>REF 144TA2325 (number of teeth = 21) (number of holes = 12)</p>	<p>REF 144TA2495 (for rubber tracks) (Ø = 309,20 mm)</p> <p>REF 144TA2513 (for steel tracks) (Ø = 295,00 mm)</p>	<p>REF 143TA9654 (320 x 54 x 72)</p>
<p>REF 144TA2204 (for rubber tracks) (nut mounted) (Ø flange = 133,00 mm) (Ø body = 95,00 mm)</p> <p>REF 144TA2249 (for steel tracks) (nut mounted) (Ø flange = 115,00 mm) (Ø body = 95,00 mm)</p> <p>REF 144TA2349 (for rubber tracks) (bolt mounted) (Ø flange = 133,00 mm) (Ø body = 95,00 mm)</p> <p>REF 144TA2407 (for steel tracks) (bolt mounted) (Ø flange = 115,00 mm) (Ø body = 95,00 mm)</p>		<p>REF 144TA2325 (number of teeth = 21) (number of holes = 12)</p>	<p>REF 144TA2495 (for rubber tracks) (Ø = 309,20 mm)</p> <p>REF 144TA2513 (for steel tracks) (Ø = 295,00 mm)</p>	<p>REF 143TA9654 (320 x 54 x 72)</p>
BOBCAT 328				
<i>S/P: 2323 - S/N: 11001 - and up</i>				
<p>REF 144TA2204 (for rubber tracks) (nut mounted) (Ø flange = 133,00 mm) (Ø body = 95,00 mm)</p> <p>REF 144TA2349 (for rubber tracks) (bolt mounted) (Ø flange = 133,00 mm) (Ø body = 95,00 mm)</p> <p>REF 144TA2407 (for steel tracks) (bolt mounted) (Ø flange = 115,00 mm) (Ø body = 95,00 mm)</p> <p>REF 144TA2249 (for steel tracks) (nut mounted) (Ø flange = 115,00 mm) (Ø body = 95,00 mm)</p> <p><i>S/P: 2324 - S/N: 11001 - and up</i></p>		<p>REF 144TA2213 (number of teeth = 21) (number of holes = 9)</p> <p>REF 144TA2325 (number of teeth = 21) (number of holes = 12)</p>	<p>REF 144TA2495 (for rubber tracks) (Ø = 309,20 mm)</p> <p>REF 144TA2513 (for steel tracks) (Ø = 295,00 mm)</p>	<p>REF 143TA9654 (320 x 54 x 72)</p>
<p>REF 144TA2204 (for rubber tracks) (nut mounted) (Ø flange = 133,00 mm) (Ø body = 95,00 mm)</p> <p>REF 144TA2249 (for steel tracks) (nut mounted) (Ø flange = 115,00 mm) (Ø body = 95,00 mm)</p>		<p>REF 144TA2213 (number of teeth = 21) (number of holes = 9)</p> <p>REF 144TA2325 (number of teeth = 21) (number of holes = 12)</p>	<p>REF 144TA2513 (for steel tracks) (Ø = 295,00 mm)</p> <p>REF 144TA2495 (for rubber tracks) (Ø = 309,20 mm)</p>	<p>REF 143TA9654 (320 x 54 x 72)</p>



TRACKS & UNDERCARRIAGE PARTS



used for BOBCAT

used for BOBCAT				
TRACK ROLLER	TOP ROLLER	SPROCKET	IDLER	TRACK
				
<p>REF 144TA2349 (for rubber tracks) (bolt mounted) (Ø flange = 133,00 mm) (Ø body = 95,00 mm)</p> <p>REF 144TA2407 (for steel tracks) (bolt mounted) (Ø flange = 115,00 mm) (Ø body = 95,00 mm)</p> <p><i>S/P: 2341 - S/N: 11001 - and up</i></p>				
<p>REF 144TA2407 (for steel tracks) (bolt mounted) (Ø flange = 115,00 mm) (Ø body = 95,00 mm)</p> <p>REF 144TA2204 (for rubber tracks) (nut mounted) (Ø flange = 133,00 mm) (Ø body = 95,00 mm)</p> <p>REF 144TA2249 (for steel tracks) (nut mounted) (Ø flange = 115,00 mm) (Ø body = 95,00 mm)</p> <p>REF 144TA2349 (for rubber tracks) (bolt mounted) (Ø flange = 133,00 mm) (Ø body = 95,00 mm)</p> <p><i>S/P: 2342 - S/N: 11001 - and up</i></p>		<p>REF 144TA2325 (number of teeth = 21) (number of holes = 12)</p>	<p>REF 144TA2495 (for rubber tracks) (Ø = 309,20 mm)</p> <p>REF 144TA2513 (for steel tracks) (Ø = 295,00 mm)</p>	<p>REF 143TA9654 (320 x 54 x 72)</p>
<p>REF 144TA2204 (for rubber tracks) (nut mounted) (Ø flange = 133,00 mm) (Ø body = 95,00 mm)</p> <p>REF 144TA2249 (for steel tracks) (nut mounted) (Ø flange = 115,00 mm) (Ø body = 95,00 mm)</p> <p>REF 144TA2349 (for rubber tracks) (bolt mounted) (Ø flange = 133,00 mm) (Ø body = 95,00 mm)</p> <p>REF 144TA2407 (for steel tracks) (bolt mounted) (Ø flange = 115,00 mm) (Ø body = 95,00 mm)</p> <p><i>S/P: 5140 - S/N: 13001 - and up</i></p>		<p>REF 144TA2325 (number of teeth = 21) (number of holes = 12)</p>	<p>REF 144TA2495 (for rubber tracks) (Ø = 309,20 mm)</p> <p>REF 144TA2513 (for steel tracks) (Ø = 295,00 mm)</p>	<p>REF 143TA9654 (320 x 54 x 72)</p>
<p>REF 144TA2349 (for rubber tracks) (bolt mounted) (Ø flange = 133,00 mm) (Ø body = 95,00 mm)</p> <p>REF 144TA2407 (for steel tracks) (bolt mounted) (Ø flange = 115,00 mm) (Ø body = 95,00 mm)</p> <p>REF 144TA2204 (for rubber tracks) (nut mounted) (Ø flange = 133,00 mm) (Ø body = 95,00 mm)</p> <p>REF 144TA2249 (for steel tracks) (nut mounted) (Ø flange = 115,00 mm) (Ø body = 95,00 mm)</p> <p><i>S/P: 5166 - S/N: 11001 - and up</i></p>		<p>REF 144TA2213 (number of teeth = 21) (number of holes = 9)</p>	<p>REF 144TA2495 (for rubber tracks) (Ø = 309,20 mm)</p> <p>REF 144TA2513 (for steel tracks) (Ø = 295,00 mm)</p>	<p>REF 143TA9654 (320 x 54 x 72)</p>
<p>REF 144TA2349 (for rubber tracks) (bolt mounted) (Ø flange = 133,00 mm) (Ø body = 95,00 mm)</p> <p>REF 144TA2407 (for steel tracks) (bolt mounted) (Ø flange = 115,00 mm) (Ø body = 95,00 mm)</p> <p>REF 144TA2204 (for rubber tracks) (nut mounted) (Ø flange = 133,00 mm) (Ø body = 95,00 mm)</p>		<p>REF 144TA2213 (number of teeth = 21) (number of holes = 9)</p>	<p>REF 144TA2495 (for rubber tracks) (Ø = 309,20 mm)</p> <p>REF 144TA2513 (for steel tracks) (Ø = 295,00 mm)</p>	<p>REF 143TA9654 (320 x 54 x 72)</p>







used for BOBCAT				
TRACK ROLLER	TOP ROLLER	SPROCKET	IDLER	TRACK
				
REF 144TA2249 (for steel tracks) (nut mounted) (Ø flange = 115,00 mm) (Ø body = 95,00 mm) <i>S/P: A9K0 - S/N: 11001 - and up</i>				
REF 144TA2204 (for rubber tracks) (nut mounted) (Ø flange = 133,00 mm) (Ø body = 95,00 mm) REF 144TA2249 (for steel tracks) (nut mounted) (Ø flange = 115,00 mm) (Ø body = 95,00 mm) REF 144TA2349 (for rubber tracks) (bolt mounted) (Ø flange = 133,00 mm) (Ø body = 95,00 mm) REF 144TA2407 (for steel tracks) (bolt mounted) (Ø flange = 115,00 mm) (Ø body = 95,00 mm) <i>S/P: A9K1 - S/N: 11001 - and up</i>		REF 144TA2325 (number of teeth = 21) (number of holes = 12)	REF 144TA2495 (for rubber tracks) (Ø = 309,20 mm) REF 144TA2513 (for steel tracks) (Ø = 295,00 mm)	REF 143TA9654 (320 x 54 x 72)
REF 144TA2204 (for rubber tracks) (nut mounted) (Ø flange = 133,00 mm) (Ø body = 95,00 mm) REF 144TA2249 (for steel tracks) (nut mounted) (Ø flange = 115,00 mm) (Ø body = 95,00 mm) REF 144TA2349 (for rubber tracks) (bolt mounted) (Ø flange = 133,00 mm) (Ø body = 95,00 mm) REF 144TA2407 (for steel tracks) (bolt mounted) (Ø flange = 115,00 mm) (Ø body = 95,00 mm) <i>S/P: AAC5 - S/N: 11001 - and up</i>		REF 144TA2325 (number of teeth = 21) (number of holes = 12)	REF 144TA2495 (for rubber tracks) (Ø = 309,20 mm) REF 144TA2513 (for steel tracks) (Ø = 295,00 mm)	REF 143TA9654 (320 x 54 x 72)
REF 144TA2349 (for rubber tracks) (bolt mounted) (Ø flange = 133,00 mm) (Ø body = 95,00 mm) REF 144TA2407 (for steel tracks) (bolt mounted) (Ø flange = 115,00 mm) (Ø body = 95,00 mm) REF 144TA2204 (for rubber tracks) (nut mounted) (Ø flange = 133,00 mm) (Ø body = 95,00 mm) REF 144TA2249 (for steel tracks) (nut mounted) (Ø flange = 115,00 mm) (Ø body = 95,00 mm) <i>S/P: AAC5 - S/N: 11001 - and up</i>		REF 144TA2325 (number of teeth = 21) (number of holes = 12)	REF 144TA2495 (for rubber tracks) (Ø = 309,20 mm) REF 144TA2513 (for steel tracks) (Ø = 295,00 mm)	REF 143TA9654 (320 x 54 x 72)
BOBCAT 329 <i>S/P: A2PG - S/N: 11001 - and up</i>				
REF 144TA2204 (for rubber tracks) (nut mounted) (Ø flange = 133,00 mm) (Ø body = 95,00 mm) REF 144TA2249 (for steel tracks) (nut mounted) (Ø flange = 115,00 mm) (Ø body = 95,00 mm) REF 144TA2349 (for rubber tracks) (bolt mounted) (Ø flange = 133,00 mm) (Ø body = 95,00 mm)		REF 144TA2325 (number of teeth = 21) (number of holes = 12)	REF 144TA2495 (for rubber tracks) (Ø = 309,20 mm) REF 144TA2513 (for steel tracks) (Ø = 295,00 mm)	REF 164TA1409 (300 x 52,5 x 80)



used for BOBCAT					
TRACK ROLLER	TOP ROLLER	SPROCKET	IDLER	TRACK	
					
<p>REF 144TA2407 (for steel tracks) (bolt mounted) (Ø flange = 115,00 mm) (Ø body = 95,00 mm)</p> <p><i>S/P: A9K2 - S/N: 11001 - and up</i></p>					
<p>REF 144TA2349 (for rubber tracks) (bolt mounted) (Ø flange = 133,00 mm) (Ø body = 95,00 mm)</p> <p>REF 144TA2407 (for steel tracks) (bolt mounted) (Ø flange = 115,00 mm) (Ø body = 95,00 mm)</p> <p>REF 144TA2204 (for rubber tracks) (nut mounted) (Ø flange = 133,00 mm) (Ø body = 95,00 mm)</p> <p>REF 144TA2249 (for steel tracks) (nut mounted) (Ø flange = 115,00 mm) (Ø body = 95,00 mm)</p>	<p>REF 144TA2325 (number of teeth = 21) (number of holes = 12)</p>			<p>REF 144TA2495 (for rubber tracks) (Ø = 309,20 mm)</p> <p>REF 144TA2513 (for steel tracks) (Ø = 295,00 mm)</p>	<p>REF 164TA1409 (300 x 52,5 x 80)</p>
<p><i>S/P: AACL - S/N: 11001 - and up</i></p>					
<p>REF 144TA2349 (for rubber tracks) (bolt mounted) (Ø flange = 133,00 mm) (Ø body = 95,00 mm)</p> <p>REF 144TA2407 (for steel tracks) (bolt mounted) (Ø flange = 115,00 mm) (Ø body = 95,00 mm)</p> <p>REF 144TA2204 (for rubber tracks) (nut mounted) (Ø flange = 133,00 mm) (Ø body = 95,00 mm)</p> <p>REF 144TA2249 (for steel tracks) (nut mounted) (Ø flange = 115,00 mm) (Ø body = 95,00 mm)</p>	<p>REF 144TA2325 (number of teeth = 21) (number of holes = 12)</p>			<p>REF 144TA2495 (for rubber tracks) (Ø = 309,20 mm) (without holes)</p> <p>REF 144TA2513 (for steel tracks) (Ø = 295,00 mm)</p>	<p>REF 164TA1409 (300 x 52,5 x 80)</p>
<p>BOBCAT 331</p> <p><i>S/P: 2325 - S/N: 11001 - 12638</i></p>					
<p>REF 144TA2204 (for rubber tracks) (nut mounted) (Ø flange = 133,00 mm) (Ø body = 95,00 mm)</p> <p>REF 144TA2249 (for steel tracks) (nut mounted) (Ø flange = 115,00 mm) (Ø body = 95,00 mm)</p> <p>REF 144TA2349 (for rubber tracks) (bolt mounted) (Ø flange = 133,00 mm) (Ø body = 95,00 mm)</p> <p>REF 144TA2407 (for steel tracks) (bolt mounted) (Ø flange = 115,00 mm) (Ø body = 95,00 mm)</p>	<p>REF 144TA2213 (number of teeth = 21) (number of holes = 9)</p>			<p>REF 144TA2495 (for rubber tracks) (Ø = 309,20 mm)</p> <p>REF 144TA2513 (for steel tracks) (Ø = 295,00 mm)</p>	<p>REF 143TA9624 (320 x 54 x 78)</p>
<p><i>S/P: 2325 - S/N: 12639 - and up</i></p>					
<p>REF 144TA2204 (for rubber tracks) (nut mounted) (Ø flange = 133,00 mm) (Ø body = 95,00 mm)</p> <p>REF 144TA2249 (for steel tracks) (nut mounted) (Ø flange = 115,00 mm) (Ø body = 95,00 mm)</p> <p>REF 144TA2349 (for rubber tracks) (bolt mounted) (Ø flange = 133,00 mm) (Ø body = 95,00 mm)</p>	<p>REF 144TA2325 (number of teeth = 21) (number of holes = 12)</p>			<p>REF 144TA2495 (for rubber tracks) (Ø = 309,20 mm)</p> <p>REF 144TA2513 (for steel tracks) (Ø = 295,00 mm)</p>	<p>REF 143TA9624 (320 x 54 x 78)</p>



used for BOBCAT				
TRACK ROLLER	TOP ROLLER	SPROCKET	IDLER	TRACK
				
<p>REF 144TA2407 (for steel tracks) (bolt mounted) (Ø flange = 115,00 mm) (Ø body = 95,00 mm) <i>S/P: 2326 - S/N: 11001 - 12097</i></p>				
<p>REF 144TA2204 (for rubber tracks) (nut mounted) (Ø flange = 133,00 mm) (Ø body = 95,00 mm)</p> <p>REF 144TA2249 (for steel tracks) (nut mounted) (Ø flange = 115,00 mm) (Ø body = 95,00 mm)</p> <p>REF 144TA2349 (for rubber tracks) (bolt mounted) (Ø flange = 133,00 mm) (Ø body = 95,00 mm)</p> <p>REF 144TA2407 (for steel tracks) (bolt mounted) (Ø flange = 115,00 mm) (Ø body = 95,00 mm)</p> <p><i>S/P: 2326 - S/N: 12098 - and up</i></p>		<p>REF 144TA2213 (number of teeth = 21) (number of holes = 9)</p>	<p>REF 144TA2495 (for rubber tracks) (Ø = 309,20 mm)</p> <p>REF 144TA2513 (for steel tracks) (Ø = 295,00 mm)</p>	<p>REF 143TA9624 (320 x 54 x 78)</p>
<p>REF 144TA2204 (for rubber tracks) (nut mounted) (Ø flange = 133,00 mm) (Ø body = 95,00 mm)</p> <p>REF 144TA2249 (for steel tracks) (nut mounted) (Ø flange = 115,00 mm) (Ø body = 95,00 mm)</p> <p>REF 144TA2349 (for rubber tracks) (bolt mounted) (Ø flange = 133,00 mm) (Ø body = 95,00 mm)</p> <p>REF 144TA2407 (for steel tracks) (bolt mounted) (Ø flange = 115,00 mm) (Ø body = 95,00 mm)</p> <p><i>S/P: 2327 - S/N: 11001 - 11411</i></p>		<p>REF 144TA2325 (number of teeth = 21) (number of holes = 12)</p>	<p>REF 144TA2495 (for rubber tracks) (Ø = 309,20 mm)</p> <p>REF 144TA2513 (for steel tracks) (Ø = 295,00 mm)</p>	<p>REF 143TA9624 (320 x 54 x 78)</p>
<p>REF 144TA2204 (for rubber tracks) (nut mounted) (Ø flange = 133,00 mm) (Ø body = 95,00 mm)</p> <p>REF 144TA2249 (for steel tracks) (nut mounted) (Ø flange = 115,00 mm) (Ø body = 95,00 mm)</p> <p>REF 144TA2349 (for rubber tracks) (bolt mounted) (Ø flange = 133,00 mm) (Ø body = 95,00 mm)</p> <p>REF 144TA2407 (for steel tracks) (bolt mounted) (Ø flange = 115,00 mm) (Ø body = 95,00 mm)</p> <p><i>S/P: 2327 - S/N: 11412 - and up</i></p>		<p>REF 144TA2213 (number of teeth = 21) (number of holes = 9)</p>	<p>REF 144TA2495 (for rubber tracks) (Ø = 309,20 mm)</p> <p>REF 144TA2513 (for steel tracks) (Ø = 295,00 mm)</p>	<p>REF 143TA9624 (320 x 54 x 78)</p>
<p>REF 144TA2204 (for rubber tracks) (nut mounted) (Ø flange = 133,00 mm) (Ø body = 95,00 mm)</p> <p>REF 144TA2249 (for steel tracks) (nut mounted) (Ø flange = 115,00 mm) (Ø body = 95,00 mm)</p> <p>REF 144TA2349 (for rubber tracks) (bolt mounted) (Ø flange = 133,00 mm) (Ø body = 95,00 mm)</p> <p>REF 144TA2407 (for steel tracks) (bolt mounted) (Ø flange = 115,00 mm) (Ø body = 95,00 mm)</p>		<p>REF 144TA2325 (number of teeth = 21) (number of holes = 12)</p>	<p>REF 144TA2495 (for rubber tracks) (Ø = 309,20 mm)</p> <p>REF 144TA2513 (for steel tracks) (Ø = 295,00 mm)</p>	<p>REF 143TA9624 (320 x 54 x 78)</p>



used for BOBCAT				
TRACK ROLLER	TOP ROLLER	SPROCKET	IDLER	TRACK
				
<i>S/P: 2343 - S/N: 11001 - 12999</i>				
<p>REF 144TA2204 (for rubber tracks) (nut mounted) (Ø flange = 133,00 mm) (Ø body = 95,00 mm)</p> <p>REF 144TA2249 (for steel tracks) (nut mounted) (Ø flange = 115,00 mm) (Ø body = 95,00 mm)</p> <p>REF 144TA2349 (for rubber tracks) (bolt mounted) (Ø flange = 133,00 mm) (Ø body = 95,00 mm)</p> <p>REF 144TA2407 (for steel tracks) (bolt mounted) (Ø flange = 115,00 mm) (Ø body = 95,00 mm)</p>		<p>REF 144TA2325 (number of teeth = 21) (number of holes = 12)</p>	<p>REF 144TA2495 (for rubber tracks) (Ø = 309,20 mm)</p> <p>REF 144TA2513 (for steel tracks) (Ø = 295,00 mm)</p>	<p>REF 143TA9624 (320 x 54 x 78)</p>
<i>S/P: 2343 - S/N: 13001 - and up</i>				
<p>REF 144TA2204 (for rubber tracks) (nut mounted) (Ø flange = 133,00 mm) (Ø body = 95,00 mm)</p> <p>REF 144TA2249 (for steel tracks) (nut mounted) (Ø flange = 115,00 mm) (Ø body = 95,00 mm)</p> <p>REF 144TA2349 (for rubber tracks) (bolt mounted) (Ø flange = 133,00 mm) (Ø body = 95,00 mm)</p> <p>REF 144TA2407 (for steel tracks) (bolt mounted) (Ø flange = 115,00 mm) (Ø body = 95,00 mm)</p>		<p>REF 144TA2325 (number of teeth = 21) (number of holes = 12)</p>	<p>REF 144TA2495 (for rubber tracks) (Ø = 309,20 mm)</p> <p>REF 144TA2513 (for steel tracks) (Ø = 295,00 mm)</p>	<p>REF 143TA9624 (320 x 54 x 78)</p>
<i>S/P: 2344 - S/N: 11001 - 11999</i>				
<p>REF 144TA2204 (for rubber tracks) (nut mounted) (Ø flange = 133,00 mm) (Ø body = 95,00 mm)</p> <p>REF 144TA2249 (for steel tracks) (nut mounted) (Ø flange = 115,00 mm) (Ø body = 95,00 mm)</p> <p>REF 144TA2349 (for rubber tracks) (bolt mounted) (Ø flange = 133,00 mm) (Ø body = 95,00 mm)</p> <p>REF 144TA2407 (for steel tracks) (bolt mounted) (Ø flange = 115,00 mm) (Ø body = 95,00 mm)</p>		<p>REF 144TA2325 (number of teeth = 21) (number of holes = 12)</p>	<p>REF 144TA2495 (for rubber tracks) (Ø = 309,20 mm)</p> <p>REF 144TA2513 (for steel tracks) (Ø = 295,00 mm)</p>	<p>REF 143TA9624 (320 x 54 x 78)</p>
<i>S/P: 2344 - S/N: 12001 - and up</i>				
<p>REF 144TA2204 (for rubber tracks) (nut mounted) (Ø flange = 133,00 mm) (Ø body = 95,00 mm)</p> <p>REF 144TA2249 (for steel tracks) (nut mounted) (Ø flange = 115,00 mm) (Ø body = 95,00 mm)</p> <p>REF 144TA2349 (for rubber tracks) (bolt mounted) (Ø flange = 133,00 mm) (Ø body = 95,00 mm)</p> <p>REF 144TA2407 (for steel tracks) (bolt mounted) (Ø flange = 115,00 mm) (Ø body = 95,00 mm)</p>		<p>REF 144TA2325 (number of teeth = 21) (number of holes = 12)</p>	<p>REF 144TA2495 (for rubber tracks) (Ø = 309,20 mm)</p> <p>REF 144TA2513 (for steel tracks) (Ø = 295,00 mm)</p>	<p>REF 143TA9624 (320 x 54 x 78)</p>







used for BOBCAT				
TRACK ROLLER	TOP ROLLER	SPROCKET	IDLER	TRACK
				
<i>S/P: 2345 - S/N: 11001 - 12999</i>				
<p>REF 144TA2204 (for rubber tracks) (nut mounted) (Ø flange = 133,00 mm) (Ø body = 95,00 mm)</p> <p>REF 144TA2249 (for steel tracks) (nut mounted) (Ø flange = 115,00 mm) (Ø body = 95,00 mm)</p> <p>REF 144TA2349 (for rubber tracks) (bolt mounted) (Ø flange = 133,00 mm) (Ø body = 95,00 mm)</p> <p>REF 144TA2407 (for steel tracks) (bolt mounted) (Ø flange = 115,00 mm) (Ø body = 95,00 mm)</p>		<p>REF 144TA2325 (number of teeth = 21) (number of holes = 12)</p>	<p>REF 144TA2495 (for rubber tracks) (Ø = 309,20 mm)</p> <p>REF 144TA2513 (for steel tracks) (Ø = 295,00 mm)</p>	<p>REF 143TA9624 (320 x 54 x 78)</p>
<i>S/P: 2345 - S/N: 13001 - and up</i>				
<p>REF 144TA2204 (for rubber tracks) (nut mounted) (Ø flange = 133,00 mm) (Ø body = 95,00 mm)</p> <p>REF 144TA2249 (for steel tracks) (nut mounted) (Ø flange = 115,00 mm) (Ø body = 95,00 mm)</p> <p>REF 144TA2349 (for rubber tracks) (bolt mounted) (Ø flange = 133,00 mm) (Ø body = 95,00 mm)</p> <p>REF 144TA2407 (for steel tracks) (bolt mounted) (Ø flange = 115,00 mm) (Ø body = 95,00 mm)</p>		<p>REF 144TA2325 (number of teeth = 21) (number of holes = 12)</p>	<p>REF 144TA2495 (for rubber tracks) (Ø = 309,20 mm)</p> <p>REF 144TA2513 (for steel tracks) (Ø = 295,00 mm)</p>	<p>REF 143TA9624 (320 x 54 x 78)</p>
<i>S/P: 2348 - S/N: 11001 - and up</i>				
<p>REF 144TA2204 (for rubber tracks) (nut mounted) (Ø flange = 133,00 mm) (Ø body = 95,00 mm)</p> <p>REF 144TA2249 (for steel tracks) (nut mounted) (Ø flange = 115,00 mm) (Ø body = 95,00 mm)</p> <p>REF 144TA2349 (for rubber tracks) (bolt mounted) (Ø flange = 133,00 mm) (Ø body = 95,00 mm)</p> <p>REF 144TA2407 (for steel tracks) (bolt mounted) (Ø flange = 115,00 mm) (Ø body = 95,00 mm)</p>		<p>REF 144TA2213 (number of teeth = 21) (number of holes = 9)</p> <p>REF 144TA2325 (number of teeth = 21) (number of holes = 12)</p>	<p>REF 144TA2495 (for rubber tracks) (Ø = 309,20 mm)</p> <p>REF 144TA2513 (for steel tracks) (Ø = 295,00 mm)</p>	<p>REF 143TA9624 (320 x 54 x 78)</p>
<i>S/P: 2350 - S/N: 11001 - and up</i>				
<p>REF 144TA2204 (for rubber tracks) (nut mounted) (Ø flange = 133,00 mm) (Ø body = 95,00 mm)</p> <p>REF 144TA2249 (for steel tracks) (nut mounted) (Ø flange = 115,00 mm) (Ø body = 95,00 mm)</p> <p>REF 144TA2349 (for rubber tracks) (bolt mounted) (Ø flange = 133,00 mm) (Ø body = 95,00 mm)</p> <p>REF 144TA2407 (for steel tracks) (bolt mounted) (Ø flange = 115,00 mm) (Ø body = 95,00 mm)</p>		<p>REF 144TA2325 (number of teeth = 21) (number of holes = 12)</p>	<p>REF 144TA2495 (for rubber tracks) (Ø = 309,20 mm)</p> <p>REF 144TA2513 (for steel tracks) (Ø = 295,00 mm)</p>	<p>REF 143TA9624 (320 x 54 x 78)</p>



used for BOBCAT				
TRACK ROLLER	TOP ROLLER	SPROCKET	IDLER	TRACK
				
<i>S/P: 5119 - S/N: 20001 - and up</i>				
<p>REF 144TA2204 (for rubber tracks) (nut mounted) (Ø flange = 133,00 mm) (Ø body = 95,00 mm)</p> <p>REF 144TA2249 (for steel tracks) (nut mounted) (Ø flange = 115,00 mm) (Ø body = 95,00 mm)</p> <p>REF 144TA2458 (for rubber tracks) (bolt mounted) (Ø flange = 130,00 mm) (Ø body = 95,50 mm)</p> <p>REF 144TA2457 (for steel tracks) (bolt mounted)</p>		<p>REF 144TA2225 (number of teeth = 21) (number of holes = 9)</p>	<p>REF 144TA2207 (Ø = 338,00 mm)</p> <p>REF 144TA2230 (Ø = 311,00 mm)</p> <p>REF 144TA2199 (Ø = 295,00 mm)</p>	<p>REF 143TA9624 (320 x 54 x 78)</p>
<i>S/P: 5129 - S/N: 11001 - 12999</i>				
<p>REF 144TA2204 (for rubber tracks) (nut mounted) (Ø flange = 133,00 mm) (Ø body = 95,00 mm)</p> <p>REF 144TA2249 (for steel tracks) (nut mounted) (Ø flange = 115,00 mm) (Ø body = 95,00 mm)</p> <p>REF 144TA2458 (for rubber tracks) (bolt mounted) (Ø flange = 130,00 mm) (Ø body = 95,50 mm)</p> <p>REF 144TA2457 (for steel tracks) (bolt mounted)</p>		<p>REF 144TA2191 (number of teeth = 21) (number of holes = 9)</p>	<p>REF 144TA2207 (Ø = 338,00 mm)</p> <p>REF 144TA2230 (Ø = 311,00 mm)</p> <p>REF 144TA2199 (Ø = 295,00 mm)</p>	<p>REF 143TA9624 (320 x 54 x 78)</p>
<i>S/P: 5129 - S/N: 13001 - and up</i>				
<p>REF 144TA2204 (for rubber tracks) (nut mounted) (Ø flange = 133,00 mm) (Ø body = 95,00 mm)</p> <p>REF 144TA2249 (for steel tracks) (nut mounted) (Ø flange = 115,00 mm) (Ø body = 95,00 mm)</p> <p>REF 144TA2349 (for rubber tracks) (bolt mounted) (Ø flange = 133,00 mm) (Ø body = 95,00 mm)</p> <p>REF 144TA2407 (for steel tracks) (bolt mounted) (Ø flange = 115,00 mm) (Ø body = 95,00 mm)</p>		<p>REF 144TA2213 (number of teeth = 21) (number of holes = 9)</p>	<p>REF 144TA2495 (for rubber tracks) (Ø = 309,20 mm)</p> <p>REF 144TA2513 (for steel tracks) (Ø = 295,00 mm)</p>	<p>REF 143TA9624 (320 x 54 x 78)</p>
<i>S/P: 5167 - S/N: 11001 - and up</i>				
<p>REF 144TA2204 (for rubber tracks) (nut mounted) (Ø flange = 133,00 mm) (Ø body = 95,00 mm)</p> <p>REF 144TA2249 (for steel tracks) (nut mounted) (Ø flange = 115,00 mm) (Ø body = 95,00 mm)</p> <p>REF 144TA2349 (for rubber tracks) (bolt mounted) (Ø flange = 133,00 mm) (Ø body = 95,00 mm)</p> <p>REF 144TA2407 (for steel tracks) (bolt mounted) (Ø flange = 115,00 mm) (Ø body = 95,00 mm)</p>		<p>REF 144TA2213 (number of teeth = 21) (number of holes = 9)</p>	<p>REF 144TA2495 (for rubber tracks) (Ø = 309,20 mm)</p> <p>REF 144TA2513 (for steel tracks) (Ø = 295,00 mm)</p>	<p>REF 143TA9624 (320 x 54 x 78)</p>
<i>S/P: 5177 - S/N: 11001 - and up</i>				
<p>REF 144TA2249 (for steel tracks) (nut mounted) (Ø flange = 115,00 mm) (Ø body = 95,00 mm)</p>		<p>REF 144TA2213 (number of teeth = 21) (number of holes = 9)</p>	<p>REF 144TA2495 (for rubber tracks) (Ø = 309,20 mm)</p>	<p>REF 143TA9624 (320 x 54 x 78)</p>



used for BOBCAT				
TRACK ROLLER	TOP ROLLER	SPROCKET	IDLER	TRACK
				
<p>REF 144TA2349 (for rubber tracks) (bolt mounted) (Ø flange = 133,00 mm) (Ø body = 95,00 mm)</p> <p>REF 144TA2407 (for steel tracks) (bolt mounted) (Ø flange = 115,00 mm) (Ø body = 95,00 mm)</p> <p>REF 144TA2204 (for rubber tracks) (nut mounted) (Ø flange = 133,00 mm) (Ø body = 95,00 mm)</p> <p><i>S/P: 5290 - S/N: 11001 - and up</i></p>			<p>REF 144TA2513 (for steel tracks) (Ø = 295,00 mm)</p>	
<p>REF 144TA2204 (for rubber tracks) (nut mounted) (Ø flange = 133,00 mm) (Ø body = 95,00 mm)</p> <p>REF 144TA2249 (for steel tracks) (nut mounted) (Ø flange = 115,00 mm) (Ø body = 95,00 mm)</p> <p>REF 144TA2349 (for rubber tracks) (bolt mounted) (Ø flange = 133,00 mm) (Ø body = 95,00 mm)</p> <p>REF 144TA2407 (for steel tracks) (bolt mounted) (Ø flange = 115,00 mm) (Ø body = 95,00 mm)</p> <p><i>S/P: 5294 - S/N: 11001 - 11124</i></p>		<p>REF 144TA2325 (number of teeth = 21) (number of holes = 12)</p>	<p>REF 144TA2495 (for rubber tracks) (Ø = 309,20 mm)</p> <p>REF 144TA2513 (for steel tracks) (Ø = 295,00 mm)</p>	<p>REF 143TA9624 (320 x 54 x 78)</p>
<p>REF 144TA2204 (for rubber tracks) (nut mounted) (Ø flange = 133,00 mm) (Ø body = 95,00 mm)</p> <p>REF 144TA2249 (for steel tracks) (nut mounted) (Ø flange = 115,00 mm) (Ø body = 95,00 mm)</p> <p>REF 144TA2349 (for rubber tracks) (bolt mounted) (Ø flange = 133,00 mm) (Ø body = 95,00 mm)</p> <p>REF 144TA2407 (for steel tracks) (bolt mounted) (Ø flange = 115,00 mm) (Ø body = 95,00 mm)</p> <p><i>S/P: 5294 - S/N: 11125 - and up</i></p>		<p>REF 144TA2325 (number of teeth = 21) (number of holes = 12)</p>	<p>REF 144TA2495 (for rubber tracks) (Ø = 309,20 mm)</p> <p>REF 144TA2513 (for steel tracks) (Ø = 295,00 mm)</p>	<p>REF 143TA9624 (320 x 54 x 78)</p>
<p>REF 144TA2204 (for rubber tracks) (nut mounted) (Ø flange = 133,00 mm) (Ø body = 95,00 mm)</p> <p>REF 144TA2249 (for steel tracks) (nut mounted) (Ø flange = 115,00 mm) (Ø body = 95,00 mm)</p> <p>REF 144TA2349 (for rubber tracks) (bolt mounted) (Ø flange = 133,00 mm) (Ø body = 95,00 mm)</p> <p>REF 144TA2407 (for steel tracks) (bolt mounted) (Ø flange = 115,00 mm) (Ø body = 95,00 mm)</p> <p><i>S/P: A00B - S/N: 11001 - and up</i></p>		<p>REF 144TA2325 (number of teeth = 21) (number of holes = 12)</p>	<p>REF 144TA2495 (for rubber tracks) (Ø = 309,20 mm)</p> <p>REF 144TA2513 (for steel tracks) (Ø = 295,00 mm)</p>	<p>REF 143TA9624 (320 x 54 x 78)</p>
<p>REF 144TA2204 (for rubber tracks) (nut mounted) (Ø flange = 133,00 mm) (Ø body = 95,00 mm)</p> <p>REF 144TA2249 (for steel tracks) (nut mounted) (Ø flange = 115,00 mm) (Ø body = 95,00 mm)</p>		<p>REF 144TA2325 (number of teeth = 21) (number of holes = 12)</p>	<p>REF 144TA2495 (for rubber tracks) (Ø = 309,20 mm)</p> <p>REF 144TA2513 (for steel tracks) (Ø = 295,00 mm)</p>	<p>REF 143TA9624 (320 x 54 x 78)</p>

TRACKS & UNDERCARRIAGE PARTS







used for BOBCAT

used for BOBCAT				
TRACK ROLLER	TOP ROLLER	SPROCKET	IDLER	TRACK
				
<p>REF 144TA2349 (for rubber tracks) (bolt mounted) (Ø flange = 133,00 mm) (Ø body = 95,00 mm)</p> <p>REF 144TA2407 (for steel tracks) (bolt mounted) (Ø flange = 115,00 mm) (Ø body = 95,00 mm)</p> <p><i>S/P: A9K5 - S/N: 11001 - and up</i></p>				
<p>REF 144TA2204 (for rubber tracks) (nut mounted) (Ø flange = 133,00 mm) (Ø body = 95,00 mm)</p> <p>REF 144TA2249 (for steel tracks) (nut mounted) (Ø flange = 115,00 mm) (Ø body = 95,00 mm)</p> <p>REF 144TA2349 (for rubber tracks) (bolt mounted) (Ø flange = 133,00 mm) (Ø body = 95,00 mm)</p> <p>REF 144TA2407 (for steel tracks) (bolt mounted) (Ø flange = 115,00 mm) (Ø body = 95,00 mm)</p> <p><i>S/P: A9K7 - S/N: 11001 - and up</i></p>		<p>REF 144TA2325 (number of teeth = 21) (number of holes = 12)</p>	<p>REF 144TA2495 (for rubber tracks) (Ø = 309,20 mm)</p> <p>REF 144TA2513 (for steel tracks) (Ø = 295,00 mm)</p>	<p>REF 143TA9624 (320 x 54 x 78)</p>
<p>REF 144TA2204 (for rubber tracks) (nut mounted) (Ø flange = 133,00 mm) (Ø body = 95,00 mm)</p> <p>REF 144TA2249 (for steel tracks) (nut mounted) (Ø flange = 115,00 mm) (Ø body = 95,00 mm)</p> <p>REF 144TA2349 (for rubber tracks) (bolt mounted) (Ø flange = 133,00 mm) (Ø body = 95,00 mm)</p> <p>REF 144TA2407 (for steel tracks) (bolt mounted) (Ø flange = 115,00 mm) (Ø body = 95,00 mm)</p> <p><i>S/P: A9K9 - S/N: 11001 - and up</i></p>		<p>REF 144TA2325 (number of teeth = 21) (number of holes = 12)</p>	<p>REF 144TA2495 (for rubber tracks) (Ø = 309,20 mm)</p> <p>REF 144TA2513 (for steel tracks) (Ø = 295,00 mm)</p>	<p>REF 143TA9624 (320 x 54 x 78)</p>
<p>REF 144TA2204 (for rubber tracks) (nut mounted) (Ø flange = 133,00 mm) (Ø body = 95,00 mm)</p> <p>REF 144TA2249 (for steel tracks) (nut mounted) (Ø flange = 115,00 mm) (Ø body = 95,00 mm)</p> <p>REF 144TA2349 (for rubber tracks) (bolt mounted) (Ø flange = 133,00 mm) (Ø body = 95,00 mm)</p> <p>REF 144TA2407 (for steel tracks) (bolt mounted) (Ø flange = 115,00 mm) (Ø body = 95,00 mm)</p> <p><i>S/P: AACS - S/N: 11001 - and up</i></p>		<p>REF 144TA2325 (number of teeth = 21) (number of holes = 12)</p>	<p>REF 144TA2495 (for rubber tracks) (Ø = 309,20 mm)</p> <p>REF 144TA2513 (for steel tracks) (Ø = 295,00 mm)</p>	<p>REF 143TA9624 (320 x 54 x 78)</p>



used for BOBCAT				
TRACK ROLLER	TOP ROLLER	SPROCKET	IDLER	TRACK
				
<p>REF 144TA2407 (for steel tracks) (bolt mounted) (Ø flange = 115,00 mm) (Ø body = 95,00 mm)</p>				
<p>BOBCAT 334 S/P: 2325 - S/N: 11001 - 12638</p>				
<p>REF 144TA2204 (for rubber tracks) (nut mounted) (Ø flange = 133,00 mm) (Ø body = 95,00 mm)</p> <p>REF 144TA2249 (for steel tracks) (nut mounted) (Ø flange = 115,00 mm) (Ø body = 95,00 mm)</p> <p>REF 144TA2349 (for rubber tracks) (bolt mounted) (Ø flange = 133,00 mm) (Ø body = 95,00 mm)</p> <p>REF 144TA2407 (for steel tracks) (bolt mounted) (Ø flange = 115,00 mm) (Ø body = 95,00 mm)</p>		<p>REF 144TA2213 (number of teeth = 21) (number of holes = 9)</p>	<p>REF 144TA2495 (for rubber tracks) (Ø = 309,20 mm)</p> <p>REF 144TA2513 (for steel tracks) (Ø = 295,00 mm)</p>	<p>REF 164TA1404 (320 x 52,5 x 80)</p>
<p>S/P: 2325 - S/N: 12639 - and up</p>				
<p>REF 144TA2204 (for rubber tracks) (nut mounted) (Ø flange = 133,00 mm) (Ø body = 95,00 mm)</p> <p>REF 144TA2249 (for steel tracks) (nut mounted) (Ø flange = 115,00 mm) (Ø body = 95,00 mm)</p> <p>REF 144TA2349 (for rubber tracks) (bolt mounted) (Ø flange = 133,00 mm) (Ø body = 95,00 mm)</p> <p>REF 144TA2407 (for steel tracks) (bolt mounted) (Ø flange = 115,00 mm) (Ø body = 95,00 mm)</p>		<p>REF 144TA2325 (number of teeth = 21) (number of holes = 12)</p>	<p>REF 144TA2495 (for rubber tracks) (Ø = 309,20 mm)</p> <p>REF 144TA2513 (for steel tracks) (Ø = 295,00 mm)</p>	<p>REF 164TA1404 (320 x 52,5 x 80)</p>
<p>S/P: 2326 - S/N: 11001 - 12097</p>				
<p>REF 144TA2204 (for rubber tracks) (nut mounted) (Ø flange = 133,00 mm) (Ø body = 95,00 mm)</p> <p>REF 144TA2249 (for steel tracks) (nut mounted) (Ø flange = 115,00 mm) (Ø body = 95,00 mm)</p> <p>REF 144TA2349 (for rubber tracks) (bolt mounted) (Ø flange = 133,00 mm) (Ø body = 95,00 mm)</p> <p>REF 144TA2407 (for steel tracks) (bolt mounted) (Ø flange = 115,00 mm) (Ø body = 95,00 mm)</p>		<p>REF 144TA2213 (number of teeth = 21) (number of holes = 9)</p>	<p>REF 144TA2495 (for rubber tracks) (Ø = 309,20 mm)</p> <p>REF 144TA2513 (for steel tracks) (Ø = 295,00 mm)</p>	<p>REF 164TA1404 (320 x 52,5 x 80)</p>
<p>S/P: 2326 - S/N: 12098 - and up</p>				
<p>REF 144TA2204 (for rubber tracks) (nut mounted) (Ø flange = 133,00 mm) (Ø body = 95,00 mm)</p> <p>REF 144TA2249 (for steel tracks) (nut mounted) (Ø flange = 115,00 mm) (Ø body = 95,00 mm)</p> <p>REF 144TA2349 (for rubber tracks) (bolt mounted) (Ø flange = 133,00 mm) (Ø body = 95,00 mm)</p>		<p>REF 144TA2325 (number of teeth = 21) (number of holes = 12)</p>	<p>REF 144TA2495 (for rubber tracks) (Ø = 309,20 mm)</p> <p>REF 144TA2513 (for steel tracks) (Ø = 295,00 mm)</p>	<p>REF 164TA1404 (320 x 52,5 x 80)</p>



used for BOBCAT				
TRACK ROLLER	TOP ROLLER	SPROCKET	IDLER	TRACK
				
<p>REF 144TA2407 (for steel tracks) (bolt mounted) (Ø flange = 115,00 mm) (Ø body = 95,00 mm) <i>S/P: 2327 - S/N: 11001 - 11411</i></p>				
<p>REF 144TA2204 (for rubber tracks) (nut mounted) (Ø flange = 133,00 mm) (Ø body = 95,00 mm)</p> <p>REF 144TA2249 (for steel tracks) (nut mounted) (Ø flange = 115,00 mm) (Ø body = 95,00 mm)</p> <p>REF 144TA2349 (for rubber tracks) (bolt mounted) (Ø flange = 133,00 mm) (Ø body = 95,00 mm)</p> <p>REF 144TA2407 (for steel tracks) (bolt mounted) (Ø flange = 115,00 mm) (Ø body = 95,00 mm)</p> <p><i>S/P: 2327 - S/N: 11412 - and up</i></p>		<p>REF 144TA2213 (number of teeth = 21) (number of holes = 9)</p>	<p>REF 144TA2495 (for rubber tracks) (Ø = 309,20 mm)</p> <p>REF 144TA2513 (for steel tracks) (Ø = 295,00 mm)</p>	<p>REF 164TA1404 (320 x 52,5 x 80)</p>
<p>REF 144TA2204 (for rubber tracks) (nut mounted) (Ø flange = 133,00 mm) (Ø body = 95,00 mm)</p> <p>REF 144TA2249 (for steel tracks) (nut mounted) (Ø flange = 115,00 mm) (Ø body = 95,00 mm)</p> <p>REF 144TA2349 (for rubber tracks) (bolt mounted) (Ø flange = 133,00 mm) (Ø body = 95,00 mm)</p> <p>REF 144TA2407 (for steel tracks) (bolt mounted) (Ø flange = 115,00 mm) (Ø body = 95,00 mm)</p> <p><i>S/P: 2343 - S/N: 11001 - 12999</i></p>		<p>REF 144TA2325 (number of teeth = 21) (number of holes = 12)</p>	<p>REF 144TA2495 (for rubber tracks) (Ø = 309,20 mm)</p> <p>REF 144TA2513 (for steel tracks) (Ø = 295,00 mm)</p>	<p>REF 164TA1404 (320 x 52,5 x 80)</p>
<p>REF 144TA2204 (for rubber tracks) (nut mounted) (Ø flange = 133,00 mm) (Ø body = 95,00 mm)</p> <p>REF 144TA2249 (for steel tracks) (nut mounted) (Ø flange = 115,00 mm) (Ø body = 95,00 mm)</p> <p>REF 144TA2349 (for rubber tracks) (bolt mounted) (Ø flange = 133,00 mm) (Ø body = 95,00 mm)</p> <p>REF 144TA2407 (for steel tracks) (bolt mounted) (Ø flange = 115,00 mm) (Ø body = 95,00 mm)</p> <p><i>S/P: 2343 - S/N: 13001 - and up</i></p>		<p>REF 144TA2325 (number of teeth = 21) (number of holes = 12)</p>	<p>REF 144TA2495 (for rubber tracks) (Ø = 309,20 mm)</p> <p>REF 144TA2513 (for steel tracks) (Ø = 295,00 mm)</p>	<p>REF 164TA1404 (320 x 52,5 x 80)</p>
<p>REF 144TA2204 (for rubber tracks) (nut mounted) (Ø flange = 133,00 mm) (Ø body = 95,00 mm)</p> <p>REF 144TA2249 (for steel tracks) (nut mounted) (Ø flange = 115,00 mm) (Ø body = 95,00 mm)</p> <p>REF 144TA2349 (for rubber tracks) (bolt mounted) (Ø flange = 133,00 mm) (Ø body = 95,00 mm)</p> <p>REF 144TA2407 (for steel tracks) (bolt mounted) (Ø flange = 115,00 mm) (Ø body = 95,00 mm)</p>		<p>REF 144TA2325 (number of teeth = 21) (number of holes = 12)</p>	<p>REF 144TA2495 (for rubber tracks) (Ø = 309,20 mm)</p> <p>REF 144TA2513 (for steel tracks) (Ø = 295,00 mm)</p>	<p>REF 164TA1404 (320 x 52,5 x 80)</p>





used for BOBCAT				
TRACK ROLLER	TOP ROLLER	SPROCKET	IDLER	TRACK
				
<i>S/P: 2344 - S/N: 11001 - 11999</i>				
<p>REF 144TA2204 (for rubber tracks) (nut mounted) (Ø flange = 133,00 mm) (Ø body = 95,00 mm)</p> <p>REF 144TA2249 (for steel tracks) (nut mounted) (Ø flange = 115,00 mm) (Ø body = 95,00 mm)</p> <p>REF 144TA2349 (for rubber tracks) (bolt mounted) (Ø flange = 133,00 mm) (Ø body = 95,00 mm)</p> <p>REF 144TA2407 (for steel tracks) (bolt mounted) (Ø flange = 115,00 mm) (Ø body = 95,00 mm)</p>		<p>REF 144TA2325 (number of teeth = 21) (number of holes = 12)</p>	<p>REF 144TA2495 (for rubber tracks) (Ø = 309,20 mm)</p> <p>REF 144TA2513 (for steel tracks) (Ø = 295,00 mm)</p>	<p>REF 164TA1404 (320 x 52,5 x 80)</p>
<i>S/P: 2344 - S/N: 12001 - and up</i>				
<p>REF 144TA2204 (for rubber tracks) (nut mounted) (Ø flange = 133,00 mm) (Ø body = 95,00 mm)</p> <p>REF 144TA2249 (for steel tracks) (nut mounted) (Ø flange = 115,00 mm) (Ø body = 95,00 mm)</p> <p>REF 144TA2349 (for rubber tracks) (bolt mounted) (Ø flange = 133,00 mm) (Ø body = 95,00 mm)</p> <p>REF 144TA2407 (for steel tracks) (bolt mounted) (Ø flange = 115,00 mm) (Ø body = 95,00 mm)</p>		<p>REF 144TA2325 (number of teeth = 21) (number of holes = 12)</p>	<p>REF 144TA2495 (for rubber tracks) (Ø = 309,20 mm)</p> <p>REF 144TA2513 (for steel tracks) (Ø = 295,00 mm)</p>	<p>REF 164TA1404 (320 x 52,5 x 80)</p>
<i>S/P: 2345 - S/N: 11001 - 12999</i>				
<p>REF 144TA2204 (for rubber tracks) (nut mounted) (Ø flange = 133,00 mm) (Ø body = 95,00 mm)</p> <p>REF 144TA2249 (for steel tracks) (nut mounted) (Ø flange = 115,00 mm) (Ø body = 95,00 mm)</p> <p>REF 144TA2349 (for rubber tracks) (bolt mounted) (Ø flange = 133,00 mm) (Ø body = 95,00 mm)</p> <p>REF 144TA2407 (for steel tracks) (bolt mounted) (Ø flange = 115,00 mm) (Ø body = 95,00 mm)</p>		<p>REF 144TA2325 (number of teeth = 21) (number of holes = 12)</p>	<p>REF 144TA2495 (for rubber tracks) (Ø = 309,20 mm)</p> <p>REF 144TA2513 (for steel tracks) (Ø = 295,00 mm)</p>	<p>REF 164TA1404 (320 x 52,5 x 80)</p>
<i>S/P: 2345 - S/N: 13001 - and up</i>				
<p>REF 144TA2204 (for rubber tracks) (nut mounted) (Ø flange = 133,00 mm) (Ø body = 95,00 mm)</p> <p>REF 144TA2249 (for steel tracks) (nut mounted) (Ø flange = 115,00 mm) (Ø body = 95,00 mm)</p> <p>REF 144TA2349 (for rubber tracks) (bolt mounted) (Ø flange = 133,00 mm) (Ø body = 95,00 mm)</p> <p>REF 144TA2407 (for steel tracks) (bolt mounted) (Ø flange = 115,00 mm) (Ø body = 95,00 mm)</p>		<p>REF 144TA2325 (number of teeth = 21) (number of holes = 12)</p>	<p>REF 144TA2513 (for steel tracks) (Ø = 295,00 mm)</p> <p>REF 144TA2495 (for rubber tracks) (Ø = 309,20 mm)</p>	<p>REF 164TA1404 (320 x 52,5 x 80)</p>



used for BOBCAT				
TRACK ROLLER	TOP ROLLER	SPROCKET	IDLER	TRACK
				
<i>S/P: 2348 - S/N: 11001 - and up</i>				
<p>REF 144TA2204 (for rubber tracks) (nut mounted) (Ø flange = 133,00 mm) (Ø body = 95,00 mm)</p> <p>REF 144TA2249 (for steel tracks) (nut mounted) (Ø flange = 115,00 mm) (Ø body = 95,00 mm)</p> <p>REF 144TA2349 (for rubber tracks) (bolt mounted) (Ø flange = 133,00 mm) (Ø body = 95,00 mm)</p> <p>REF 144TA2407 (for steel tracks) (bolt mounted) (Ø flange = 115,00 mm) (Ø body = 95,00 mm)</p>		<p>REF 144TA2213 (number of teeth = 21) (number of holes = 9)</p> <p>REF 144TA2325 (number of teeth = 21) (number of holes = 12)</p>	<p>REF 144TA2495 (for rubber tracks) (Ø = 309,20 mm)</p> <p>REF 144TA2513 (for steel tracks) (Ø = 295,00 mm)</p>	<p>REF 164TA1404 (320 x 52,5 x 80)</p>
<i>S/P: 2350 - S/N: 11001 - and up</i>				
<p>REF 144TA2204 (for rubber tracks) (nut mounted) (Ø flange = 133,00 mm) (Ø body = 95,00 mm)</p> <p>REF 144TA2249 (for steel tracks) (nut mounted) (Ø flange = 115,00 mm) (Ø body = 95,00 mm)</p> <p>REF 144TA2349 (for rubber tracks) (bolt mounted) (Ø flange = 133,00 mm) (Ø body = 95,00 mm)</p> <p>REF 144TA2407 (for steel tracks) (bolt mounted) (Ø flange = 115,00 mm) (Ø body = 95,00 mm)</p>		<p>REF 144TA2325 (number of teeth = 21) (number of holes = 12)</p>	<p>REF 144TA2495 (for rubber tracks) (Ø = 309,20 mm)</p> <p>REF 144TA2513 (for steel tracks) (Ø = 295,00 mm)</p>	<p>REF 164TA1404 (320 x 52,5 x 80)</p>
<i>S/P: 5129 - S/N: 13001 - and up</i>				
<p>REF 144TA2204 (for rubber tracks) (nut mounted) (Ø flange = 133,00 mm) (Ø body = 95,00 mm)</p> <p>REF 144TA2249 (for steel tracks) (nut mounted) (Ø flange = 115,00 mm) (Ø body = 95,00 mm)</p> <p>REF 144TA2349 (for rubber tracks) (bolt mounted) (Ø flange = 133,00 mm) (Ø body = 95,00 mm)</p> <p>REF 144TA2407 (for steel tracks) (bolt mounted) (Ø flange = 115,00 mm) (Ø body = 95,00 mm)</p>		<p>REF 144TA2213 (number of teeth = 21) (number of holes = 9)</p>	<p>REF 144TA2495 (for rubber tracks) (Ø = 309,20 mm)</p> <p>REF 144TA2513 (for steel tracks) (Ø = 295,00 mm)</p>	<p>REF 164TA1404 (320 x 52,5 x 80)</p>
<i>S/P: 5167 - S/N: 11001 - and up</i>				
<p>REF 144TA2204 (for rubber tracks) (nut mounted) (Ø flange = 133,00 mm) (Ø body = 95,00 mm)</p> <p>REF 144TA2249 (for steel tracks) (nut mounted) (Ø flange = 115,00 mm) (Ø body = 95,00 mm)</p> <p>REF 144TA2349 (for rubber tracks) (bolt mounted) (Ø flange = 133,00 mm) (Ø body = 95,00 mm)</p> <p>REF 144TA2407 (for steel tracks) (bolt mounted) (Ø flange = 115,00 mm) (Ø body = 95,00 mm)</p>		<p>REF 144TA2213 (number of teeth = 21) (number of holes = 9)</p>	<p>REF 144TA2495 (for rubber tracks) (Ø = 309,20 mm)</p> <p>REF 144TA2513 (for steel tracks) (Ø = 295,00 mm)</p>	<p>REF 164TA1404 (320 x 52,5 x 80)</p>



used for BOBCAT				
TRACK ROLLER	TOP ROLLER	SPROCKET	IDLER	TRACK
				
<i>S/P: 5177 - S/N: 11001 - and up</i>				
<p>REF 144TA2204 (for rubber tracks) (nut mounted) (∅ flange = 133,00 mm) (∅ body = 95,00 mm)</p> <p>REF 144TA2249 (for steel tracks) (nut mounted) (∅ flange = 115,00 mm) (∅ body = 95,00 mm)</p> <p>REF 144TA2349 (for rubber tracks) (bolt mounted) (∅ flange = 133,00 mm) (∅ body = 95,00 mm)</p> <p>REF 144TA2407 (for steel tracks) (bolt mounted) (∅ flange = 115,00 mm) (∅ body = 95,00 mm)</p>		<p>REF 144TA2213 (number of teeth = 21) (number of holes = 9)</p>	<p>REF 144TA2495 (for rubber tracks) (∅ = 309,20 mm)</p> <p>REF 144TA2513 (for steel tracks) (∅ = 295,00 mm)</p>	<p>REF 164TA1404 (320 x 52,5 x 80)</p>
<i>S/P: 5290 - S/N: 11001 - and up</i>				
<p>REF 144TA2204 (for rubber tracks) (nut mounted) (∅ flange = 133,00 mm) (∅ body = 95,00 mm)</p> <p>REF 144TA2249 (for steel tracks) (nut mounted) (∅ flange = 115,00 mm) (∅ body = 95,00 mm)</p> <p>REF 144TA2349 (for rubber tracks) (bolt mounted) (∅ flange = 133,00 mm) (∅ body = 95,00 mm)</p> <p>REF 144TA2407 (for steel tracks) (bolt mounted) (∅ flange = 115,00 mm) (∅ body = 95,00 mm)</p>		<p>REF 144TA2325 (number of teeth = 21) (number of holes = 12)</p>	<p>REF 144TA2495 (for rubber tracks) (∅ = 309,20 mm)</p> <p>REF 144TA2513 (for steel tracks) (∅ = 295,00 mm)</p>	<p>REF 164TA1404 (320 x 52,5 x 80)</p>
<i>S/P: 5294 - S/N: 11001 - 11124</i>				
<p>REF 144TA2249 (for steel tracks) (nut mounted) (∅ flange = 115,00 mm) (∅ body = 95,00 mm)</p> <p>REF 144TA2349 (for rubber tracks) (bolt mounted) (∅ flange = 133,00 mm) (∅ body = 95,00 mm)</p> <p>REF 144TA2407 (for steel tracks) (bolt mounted) (∅ flange = 115,00 mm) (∅ body = 95,00 mm)</p> <p>REF 144TA2204 (for rubber tracks) (nut mounted) (∅ flange = 133,00 mm) (∅ body = 95,00 mm)</p>		<p>REF 144TA2325 (number of teeth = 21) (number of holes = 12)</p>	<p>REF 144TA2495 (for rubber tracks) (∅ = 309,20 mm)</p> <p>REF 144TA2513 (for steel tracks) (∅ = 295,00 mm)</p>	<p>REF 164TA1404 (320 x 52,5 x 80)</p>
<i>S/P: 5294 - S/N: 11125 - and up</i>				
<p>REF 144TA2204 (for rubber tracks) (nut mounted) (∅ flange = 133,00 mm) (∅ body = 95,00 mm)</p> <p>REF 144TA2249 (for steel tracks) (nut mounted) (∅ flange = 115,00 mm) (∅ body = 95,00 mm)</p> <p>REF 144TA2349 (for rubber tracks) (bolt mounted) (∅ flange = 133,00 mm) (∅ body = 95,00 mm)</p> <p>REF 144TA2407 (for steel tracks) (bolt mounted) (∅ flange = 115,00 mm) (∅ body = 95,00 mm)</p>		<p>REF 144TA2325 (number of teeth = 21) (number of holes = 12)</p>	<p>REF 144TA2495 (for rubber tracks) (∅ = 309,20 mm)</p> <p>REF 144TA2513 (for steel tracks) (∅ = 295,00 mm)</p>	<p>REF 164TA1404 (320 x 52,5 x 80)</p>



used for BOBCAT				
TRACK ROLLER	TOP ROLLER	SPROCKET	IDLER	TRACK
				
<i>S/P: A00B - S/N: 11001 - and up</i>				
<p>REF 144TA2204 (for rubber tracks) (nut mounted) (Ø flange = 133,00 mm) (Ø body = 95,00 mm)</p> <p>REF 144TA2249 (for steel tracks) (nut mounted) (Ø flange = 115,00 mm) (Ø body = 95,00 mm)</p> <p>REF 144TA2349 (for rubber tracks) (bolt mounted) (Ø flange = 133,00 mm) (Ø body = 95,00 mm)</p> <p>REF 144TA2407 (for steel tracks) (bolt mounted) (Ø flange = 115,00 mm) (Ø body = 95,00 mm)</p>		<p>REF 144TA2325 (number of teeth = 21) (number of holes = 12)</p>	<p>REF 144TA2495 (for rubber tracks) (Ø = 309,20 mm)</p> <p>REF 144TA2513 (for steel tracks) (Ø = 295,00 mm)</p>	<p>REF 164TA1404 (320 x 52,5 x 80)</p>
<i>S/P: A9K5 - S/N: 11001 - and up</i>				
<p>REF 144TA2204 (for rubber tracks) (nut mounted) (Ø flange = 133,00 mm) (Ø body = 95,00 mm)</p> <p>REF 144TA2249 (for steel tracks) (nut mounted) (Ø flange = 115,00 mm) (Ø body = 95,00 mm)</p> <p>REF 144TA2349 (for rubber tracks) (bolt mounted) (Ø flange = 133,00 mm) (Ø body = 95,00 mm)</p> <p>REF 144TA2407 (for steel tracks) (bolt mounted) (Ø flange = 115,00 mm) (Ø body = 95,00 mm)</p>		<p>REF 144TA2325 (number of teeth = 21) (number of holes = 12)</p>	<p>REF 144TA2495 (for rubber tracks) (Ø = 309,20 mm)</p> <p>REF 144TA2513 (for steel tracks) (Ø = 295,00 mm)</p>	<p>REF 164TA1404 (320 x 52,5 x 80)</p>
<i>S/P: A9K7 - S/N: 11001 - and up</i>				
<p>REF 144TA2204 (for rubber tracks) (nut mounted) (Ø flange = 133,00 mm) (Ø body = 95,00 mm)</p> <p>REF 144TA2249 (for steel tracks) (nut mounted) (Ø flange = 115,00 mm) (Ø body = 95,00 mm)</p> <p>REF 144TA2349 (for rubber tracks) (bolt mounted) (Ø flange = 133,00 mm) (Ø body = 95,00 mm)</p> <p>REF 144TA2407 (for steel tracks) (bolt mounted) (Ø flange = 115,00 mm) (Ø body = 95,00 mm)</p>		<p>REF 144TA2325 (number of teeth = 21) (number of holes = 12)</p>	<p>REF 144TA2495 (for rubber tracks) (Ø = 309,20 mm)</p> <p>REF 144TA2513 (for steel tracks) (Ø = 295,00 mm)</p>	<p>REF 164TA1404 (320 x 52,5 x 80)</p>
<i>S/P: A9K9 - S/N: 11001 - and up</i>				
<p>REF 144TA2204 (for rubber tracks) (nut mounted) (Ø flange = 133,00 mm) (Ø body = 95,00 mm)</p> <p>REF 144TA2249 (for steel tracks) (nut mounted) (Ø flange = 115,00 mm) (Ø body = 95,00 mm)</p> <p>REF 144TA2349 (for rubber tracks) (bolt mounted) (Ø flange = 133,00 mm) (Ø body = 95,00 mm)</p> <p>REF 144TA2407 (for steel tracks) (bolt mounted) (Ø flange = 115,00 mm) (Ø body = 95,00 mm)</p>		<p>REF 144TA2325 (number of teeth = 21) (number of holes = 12)</p>	<p>REF 144TA2495 (for rubber tracks) (Ø = 309,20 mm)</p> <p>REF 144TA2513 (for steel tracks) (Ø = 295,00 mm)</p>	<p>REF 164TA1404 (320 x 52,5 x 80)</p>



used for BOBCAT				
TRACK ROLLER	TOP ROLLER	SPROCKET	IDLER	TRACK
				
<i>S/P: AACS - S/N: 11001 - and up</i>				
<p>REF 144TA2204 (for rubber tracks) (nut mounted) (∅ flange = 133,00 mm) (∅ body = 95,00 mm)</p> <p>REF 144TA2249 (for steel tracks) (nut mounted) (∅ flange = 115,00 mm) (∅ body = 95,00 mm)</p> <p>REF 144TA2349 (for rubber tracks) (bolt mounted) (∅ flange = 133,00 mm) (∅ body = 95,00 mm)</p> <p>REF 144TA2407 (for steel tracks) (bolt mounted) (∅ flange = 115,00 mm) (∅ body = 95,00 mm)</p>		<p>REF 144TA2325 (number of teeth = 21) (number of holes = 12)</p>	<p>REF 144TA2495 (for rubber tracks) (∅ = 309,20 mm)</p> <p>REF 144TA2513 (for steel tracks) (∅ = 295,00 mm)</p>	<p>REF 164TA1404 (320 x 52,5 x 80)</p>
BOBCAT 335				
<i>S/P: A16U - S/N: 11001 - and up</i>				
<p>REF 144TA2204 (for rubber tracks) (nut mounted) (∅ flange = 133,00 mm) (∅ body = 95,00 mm)</p> <p>REF 144TA2249 (for steel tracks) (nut mounted) (∅ flange = 115,00 mm) (∅ body = 95,00 mm)</p> <p>REF 144TA2349 (for rubber tracks) (bolt mounted) (∅ flange = 133,00 mm) (∅ body = 95,00 mm)</p> <p>REF 144TA2407 (for steel tracks) (bolt mounted) (∅ flange = 115,00 mm) (∅ body = 95,00 mm)</p>	<p>REF 144TA2241 (nut mounted) (∅ flange = 115,00 mm) (∅ body = 80,00 mm)</p> <p>REF 144TA2348 (bolt mounted) (∅ flange = 115,00 mm) (∅ body = 80,00 mm)</p>	<p>REF 144TA2494 (number of teeth = 23) (number of holes = 12)</p>	<p>REF 144TA2495 (for rubber tracks) (∅ = 309,20 mm)</p> <p>REF 144TA2513 (for steel tracks) (∅ = 295,00 mm)</p>	<p>REF 143TA9626 (300 x 52,5 x 80)</p>
<i>S/P: A9KA - S/N: 11001 - and up</i>				
<p>REF 144TA2204 (for rubber tracks) (nut mounted) (∅ flange = 133,00 mm) (∅ body = 95,00 mm)</p> <p>REF 144TA2249 (for steel tracks) (nut mounted) (∅ flange = 115,00 mm) (∅ body = 95,00 mm)</p> <p>REF 144TA2349 (for rubber tracks) (bolt mounted) (∅ flange = 133,00 mm) (∅ body = 95,00 mm)</p> <p>REF 144TA2407 (for steel tracks) (bolt mounted) (∅ flange = 115,00 mm) (∅ body = 95,00 mm)</p>	<p>REF 144TA2241 (nut mounted) (∅ flange = 115,00 mm) (∅ body = 80,00 mm)</p> <p>REF 144TA2348 (bolt mounted) (∅ flange = 115,00 mm) (∅ body = 80,00 mm)</p>	<p>REF 144TA2494 (number of teeth = 23) (number of holes = 12)</p>	<p>REF 144TA2495 (for rubber tracks) (∅ = 309,20 mm)</p> <p>REF 144TA2513 (for steel tracks) (∅ = 295,00 mm)</p>	<p>REF 143TA9626 (300 x 52,5 x 92)</p>
<i>S/P: AAD1 - S/N: 11001 - and up</i>				
<p>REF 144TA2204 (for rubber tracks) (nut mounted) (∅ flange = 133,00 mm) (∅ body = 95,00 mm)</p> <p>REF 144TA2249 (for steel tracks) (nut mounted) (∅ flange = 115,00 mm) (∅ body = 95,00 mm)</p>	<p>REF 144TA2241 (nut mounted) (∅ flange = 115,00 mm) (∅ body = 80,00 mm)</p> <p>REF 144TA2348 (bolt mounted) (∅ flange = 115,00 mm) (∅ body = 80,00 mm)</p>	<p>REF 144TA2494 (number of teeth = 23) (number of holes = 12)</p>	<p>REF 144TA2513 (for steel tracks) (∅ = 295,00 mm)</p> <p>REF 144TA2495 (for rubber tracks) (∅ = 309,20 mm)</p>	<p>REF 143TA9626 (300 x 52,5 x 92)</p>



used for BOBCAT				
TRACK ROLLER	TOP ROLLER	SPROCKET	IDLER	TRACK
				
<p>REF 144TA2349 (for rubber tracks) (bolt mounted) (Ø flange = 133,00 mm) (Ø body = 95,00 mm)</p> <p>REF 144TA2407 (for steel tracks) (bolt mounted) (Ø flange = 115,00 mm) (Ø body = 95,00 mm)</p>				
BOBCAT 337				
<i>S/P: 2306 - S/N: 11001 - and up</i>				
<p>REF 144TA2351 (for rubber tracks) (bolt mounted) (Ø flange = 159,00 mm) (Ø body = 115,00 mm)</p> <p>REF 144TA2453 (for steel tracks) (bolt mounted)</p>		<p>REF 144TA2201 (number of teeth = 21) (number of holes = 12)</p>	<p>REF 144TA2291 (Ø = 416,00 mm)</p>	<p>REF 164TA1419 (400 x 72,50 x 74)</p>
<i>S/P: 2332 - S/N: 11001 - and up</i>				
<p>REF 144TA2351 (for rubber tracks) (bolt mounted) (Ø flange = 159,00 mm) (Ø body = 115,00 mm)</p> <p>REF 144TA2453 (for steel tracks) (bolt mounted)</p>		<p>REF 144TA2255 (number of teeth = 21) (number of holes = 12)</p>	<p>REF 144TA2291 (Ø = 416,00 mm)</p>	<p>REF 164TA1419 (400 x 72,50 x 74)</p>
<i>S/P: 2333 - S/N: 11001 - and up</i>				
<p>REF 144TA2351 (for rubber tracks) (bolt mounted) (Ø flange = 159,00 mm) (Ø body = 115,00 mm)</p> <p>REF 144TA2453 (for steel tracks) (bolt mounted)</p>		<p>REF 144TA2255 (number of teeth = 21) (number of holes = 12)</p>	<p>REF 144TA2291 (Ø = 416,00 mm)</p>	<p>REF 164TA1419 (400 x 72,50 x 74)</p>
<i>S/P: 2346 - S/N: 11001 - and up</i>				
<p>REF 144TA2252 (for rubber tracks) (nut mounted) (Ø flange = 159,00 mm) (Ø body = 115,00 mm)</p> <p>REF 144TA2253 (for steel tracks) (nut mounted)</p> <p>REF 144TA2351 (for rubber tracks) (bolt mounted) (Ø flange = 159,00 mm) (Ø body = 115,00 mm)</p> <p>REF 144TA2453 (for steel tracks) (bolt mounted)</p>	<p>REF 144TA2204 (for rubber tracks) (nut mounted) (Ø flange = 133,00 mm) (Ø body = 95,00 mm)</p> <p>REF 144TA2249 (for steel tracks) (nut mounted) (Ø flange = 115,00 mm) (Ø body = 95,00 mm)</p> <p>REF 144TA2453 (bolt mounted)</p>	<p>REF 144TA2255 (number of teeth = 21) (number of holes = 12)</p>	<p>REF 144TA2291 (Ø = 416,00 mm)</p>	<p>REF 164TA1419 (400 x 72,50 x 74)</p>
<i>S/P: 2347 - S/N: 11001 - and up</i>				
<p>REF 144TA2252 (for rubber tracks) (nut mounted) (Ø flange = 159,00 mm) (Ø body = 115,00 mm)</p> <p>REF 144TA2253 (for steel tracks) (nut mounted)</p>	<p>REF 144TA2249 (for steel tracks) (nut mounted) (Ø flange = 115,00 mm) (Ø body = 95,00 mm)</p> <p>REF 144TA2454 (bolt mounted) (Ø flange = 119,00 mm) (Ø body = 95,50 mm)</p>	<p>REF 144TA2255 (number of teeth = 21) (number of holes = 12)</p>	<p>REF 144TA2291 (Ø = 416,00 mm)</p>	<p>REF 164TA1419 (400 x 72,50 x 74)</p>



used for BOBCAT				
TRACK ROLLER	TOP ROLLER	SPROCKET	IDLER	TRACK
				
<p>REF 144TA2351 (for rubber tracks) (bolt mounted) (Ø flange = 159,00 mm) (Ø body = 115,00 mm)</p> <p>REF 144TA2453 (for steel tracks) (bolt mounted)</p> <p><i>S/P: 2349 - S/N: 11001 - and up</i></p>	<p>REF 144TA2204 (for rubber tracks) (nut mounted) (Ø flange = 133,00 mm) (Ø body = 95,00 mm)</p>			
<p>REF 144TA2351 (for rubber tracks) (bolt mounted) (Ø flange = 159,00 mm) (Ø body = 115,00 mm)</p> <p>REF 144TA2453 (for steel tracks) (bolt mounted)</p> <p><i>S/P: 5154 - S/N: 11001 - and up</i></p>		<p>REF 144TA2255 (number of teeth = 21) (number of holes = 12)</p>	<p>REF 144TA2291 (Ø = 416,00 mm)</p>	<p>REF 164TA1419 (400 x 72,50 x 74)</p>
<p>REF 144TA2351 (for rubber tracks) (bolt mounted) (Ø flange = 159,00 mm) (Ø body = 115,00 mm)</p> <p>REF 144TA2453 (for steel tracks) (bolt mounted)</p> <p><i>S/P: 5295 - S/N: 11001 - and up</i></p>		<p>REF 144TA2201 (number of teeth = 21) (number of holes = 12)</p>	<p>REF 144TA2291 (Ø = 416,00 mm)</p>	<p>REF 164TA1419 (400 x 72,50 x 74)</p>
<p>REF 144TA2252 (for rubber tracks) (nut mounted) (Ø flange = 159,00 mm) (Ø body = 115,00 mm)</p> <p>REF 144TA2253 (for steel tracks) (nut mounted)</p> <p>REF 144TA2351 (for rubber tracks) (bolt mounted) (Ø flange = 159,00 mm) (Ø body = 115,00 mm)</p> <p>REF 144TA2453 (for steel tracks) (bolt mounted)</p> <p><i>S/P: A00C - S/N: 11001 - and up</i></p>	<p>REF 144TA2454 (bolt mounted) (Ø flange = 119,00 mm) (Ø body = 95,50 mm)</p>	<p>REF 144TA2255 (number of teeth = 21) (number of holes = 12)</p>	<p>REF 144TA2291 (Ø = 416,00 mm)</p>	<p>REF 164TA1419 (400 x 72,50 x 74)</p>
<p>REF 144TA2252 (for rubber tracks) (nut mounted) (Ø flange = 159,00 mm) (Ø body = 115,00 mm)</p> <p>REF 144TA2253 (for steel tracks) (nut mounted)</p> <p>REF 144TA2351 (for rubber tracks) (bolt mounted) (Ø flange = 159,00 mm) (Ø body = 115,00 mm)</p> <p>REF 144TA2453 (for steel tracks) (bolt mounted)</p> <p><i>S/P: A9W7 - S/N: 11001 - and up</i></p>	<p>REF 144TA2454 (bolt mounted) (Ø flange = 119,00 mm) (Ø body = 95,50 mm)</p>	<p>REF 144TA2255 (number of teeth = 21) (number of holes = 12)</p>	<p>REF 144TA2291 (Ø = 416,00 mm)</p>	<p>REF 164TA1419 (400 x 72,50 x 74)</p>
<p>REF 144TA2252 (for rubber tracks) (nut mounted) (Ø flange = 159,00 mm) (Ø body = 115,00 mm)</p> <p>REF 144TA2253 (for steel tracks) (nut mounted)</p>	<p>REF 144TA2204 (for rubber tracks) (nut mounted) (Ø flange = 133,00 mm) (Ø body = 95,00 mm)</p> <p>REF 144TA2249 (for steel tracks) (nut mounted) (Ø flange = 115,00 mm) (Ø body = 95,00 mm)</p>	<p>REF 144TA2255 (number of teeth = 21) (number of holes = 12)</p>	<p>REF 144TA2291 (Ø = 416,00 mm)</p>	<p>REF 164TA1419 (400 x 72,50 x 74)</p>

TRACKS & UNDERCARRIAGE PARTS



used for BOBCAT

used for BOBCAT				
TRACK ROLLER	TOP ROLLER	SPROCKET	IDLER	TRACK
				
<p>REF 144TA2351 (for rubber tracks) (bolt mounted) (Ø flange = 159,00 mm) (Ø body = 115,00 mm)</p> <p>REF 144TA2453 (for steel tracks) (bolt mounted)</p> <p><i>S/P: A9W9 - S/N: 11001 - and up</i></p>	<p>REF 144TA2454 (bolt mounted) (Ø flange = 119,00 mm) (Ø body = 95,50 mm)</p>			
<p>REF 144TA2252 (for rubber tracks) (nut mounted) (Ø flange = 159,00 mm) (Ø body = 115,00 mm)</p> <p>REF 144TA2253 (for steel tracks) (nut mounted)</p> <p>REF 144TA2351 (for rubber tracks) (bolt mounted) (Ø flange = 159,00 mm) (Ø body = 115,00 mm)</p> <p>REF 144TA2453 (for steel tracks) (bolt mounted)</p> <p><i>S/P: AAC8 - S/N: 11001 - and up</i></p>	<p>REF 144TA2204 (for rubber tracks) (nut mounted) (Ø flange = 133,00 mm) (Ø body = 95,00 mm)</p> <p>REF 144TA2249 (for steel tracks) (nut mounted) (Ø flange = 115,00 mm) (Ø body = 95,00 mm)</p> <p>REF 144TA2454 (bolt mounted) (Ø flange = 119,00 mm) (Ø body = 95,50 mm)</p>	<p>REF 144TA2255 (number of teeth = 21) (number of holes = 12)</p>	<p>REF 144TA2291 (Ø = 416,00 mm)</p>	<p>REF 164TA1419 (400 x 72,50 x 74)</p>
<p>REF 144TA2252 (for rubber tracks) (nut mounted) (Ø flange = 159,00 mm) (Ø body = 115,00 mm)</p> <p>REF 144TA2253 (for steel tracks) (nut mounted)</p> <p>REF 144TA2351 (for rubber tracks) (bolt mounted) (Ø flange = 159,00 mm) (Ø body = 115,00 mm)</p> <p>REF 144TA2453 (for steel tracks) (bolt mounted)</p>	<p>REF 144TA2204 (for rubber tracks) (nut mounted) (Ø flange = 133,00 mm) (Ø body = 95,00 mm)</p> <p>REF 144TA2249 (for steel tracks) (nut mounted) (Ø flange = 115,00 mm) (Ø body = 95,00 mm)</p> <p>REF 144TA2454 (bolt mounted) (Ø flange = 119,00 mm) (Ø body = 95,50 mm)</p>	<p>REF 144TA2255 (number of teeth = 21) (number of holes = 12)</p>	<p>REF 144TA2291 (Ø = 416,00 mm)</p>	<p>REF 164TA1419 (400 x 72,50 x 74)</p>
BOBCAT 341				
<i>S/P: 2306 - S/N: 11001 - and up</i>				
<p>REF 144TA2351 (for rubber tracks) (bolt mounted) (Ø flange = 159,00 mm) (Ø body = 115,00 mm)</p> <p>REF 144TA2453 (for steel tracks) (bolt mounted)</p> <p><i>S/P: 2332 - S/N: 11001 - and up</i></p>		<p>REF 144TA2201 (number of teeth = 21) (number of holes = 12)</p>	<p>REF 144TA2291 (Ø = 416,00 mm)</p>	<p>REF 140TA8643 (400 x 72,5 x 74)</p>
<p>REF 144TA2351 (for rubber tracks) (bolt mounted) (Ø flange = 159,00 mm) (Ø body = 115,00 mm)</p> <p>REF 144TA2453 (for steel tracks) (bolt mounted)</p>		<p>REF 144TA2255 (number of teeth = 21) (number of holes = 12)</p>	<p>REF 144TA2291 (Ø = 416,00 mm)</p>	<p>REF 140TA8643 (400 x 72,5 x 74)</p>



used for BOBCAT				
TRACK ROLLER	TOP ROLLER	SPROCKET	IDLER	TRACK
				
<i>S/P: 2333 - S/N: 11001 - and up</i>				
<p>REF 144TA2453 (for steel tracks) (bolt mounted)</p> <p>REF 144TA2351 (for rubber tracks) (bolt mounted) (Ø flange = 159,00 mm) (Ø body = 115,00 mm)</p>		<p>REF 144TA2255 (number of teeth = 21) (number of holes = 12)</p>	<p>REF 144TA2291 (Ø = 416,00 mm)</p>	<p>REF 140TA8643 (400 x 72,5 x 74)</p>
<i>S/P: 2346 - S/N: 11001 - and up</i>				
<p>REF 144TA2252 (for rubber tracks) (nut mounted) (Ø flange = 159,00 mm) (Ø body = 115,00 mm)</p> <p>REF 144TA2253 (for steel tracks) (nut mounted)</p> <p>REF 144TA2351 (for rubber tracks) (bolt mounted) (Ø flange = 159,00 mm) (Ø body = 115,00 mm)</p> <p>REF 144TA2453 (for steel tracks) (bolt mounted)</p>	<p>REF 144TA2454 (bolt mounted) (Ø flange = 119,00 mm) (Ø body = 95,50 mm)</p>	<p>REF 144TA2255 (number of teeth = 21) (number of holes = 12)</p>	<p>REF 144TA2291 (Ø = 416,00 mm)</p>	<p>REF 140TA8643 (400 x 72,5 x 74)</p>
<i>S/P: 2346 - S/N: 11164 - and up</i>				
<p>REF 144TA2252 (for rubber tracks) (nut mounted) (Ø flange = 159,00 mm) (Ø body = 115,00 mm)</p> <p>REF 144TA2253 (for steel tracks) (nut mounted)</p> <p>REF 144TA2351 (for rubber tracks) (bolt mounted) (Ø flange = 159,00 mm) (Ø body = 115,00 mm)</p> <p>REF 144TA2453 (for steel tracks) (bolt mounted)</p>	<p>REF 144TA2204 (for rubber tracks) (nut mounted) (Ø flange = 133,00 mm) (Ø body = 95,00 mm)</p> <p>REF 144TA2249 (for steel tracks) (nut mounted) (Ø flange = 115,00 mm) (Ø body = 95,00 mm)</p> <p>REF 144TA2454 (bolt mounted) (Ø flange = 119,00 mm) (Ø body = 95,50 mm)</p>	<p>REF 144TA2255 (number of teeth = 21) (number of holes = 12)</p>	<p>REF 144TA2291 (Ø = 416,00 mm)</p>	<p>REF 140TA8643 (400 x 72,5 x 74)</p>
<i>S/P: 2347 - S/N: 11001 - and up</i>				
<p>REF 144TA2252 (for rubber tracks) (nut mounted) (Ø flange = 159,00 mm) (Ø body = 115,00 mm)</p> <p>REF 144TA2253 (for steel tracks) (nut mounted)</p> <p>REF 144TA2351 (for rubber tracks) (bolt mounted) (Ø flange = 159,00 mm) (Ø body = 115,00 mm)</p> <p>REF 144TA2453 (for steel tracks) (bolt mounted)</p>	<p>REF 144TA2454 (bolt mounted) (Ø flange = 119,00 mm) (Ø body = 95,50 mm)</p>	<p>REF 144TA2255 (number of teeth = 21) (number of holes = 12)</p>	<p>REF 144TA2291 (Ø = 416,00 mm)</p>	<p>REF 140TA8643 (400 x 72,5 x 74)</p>
<i>S/P: 2347 - S/N: 11198 - and up</i>				
<p>REF 144TA2252 (for rubber tracks) (nut mounted) (Ø flange = 159,00 mm) (Ø body = 115,00 mm)</p>	<p>REF 144TA2249 (for steel tracks) (nut mounted) (Ø flange = 115,00 mm) (Ø body = 95,00 mm)</p>	<p>REF 144TA2255 (number of teeth = 21) (number of holes = 12)</p>	<p>REF 144TA2291 (Ø = 416,00 mm)</p>	<p>REF 140TA8643 (400 x 72,5 x 74)</p>



used for BOBCAT				
TRACK ROLLER	TOP ROLLER	SPROCKET	IDLER	TRACK
				
<p>REF 144TA2253 (for steel tracks) (nut mounted)</p> <p>REF 144TA2351 (for rubber tracks) (bolt mounted) (Ø flange = 159,00 mm) (Ø body = 115,00 mm)</p> <p>REF 144TA2453 (for steel tracks) (bolt mounted)</p> <p><i>S/P: 2349 - S/N: 11001 - and up</i></p>	<p>REF 144TA2204 (for rubber tracks) (nut mounted) (Ø flange = 133,00 mm) (Ø body = 95,00 mm)</p> <p>REF 144TA2454 (bolt mounted) (Ø flange = 119,00 mm) (Ø body = 95,50 mm)</p>			
<p>REF 144TA2351 (for rubber tracks) (bolt mounted) (Ø flange = 159,00 mm) (Ø body = 115,00 mm)</p> <p>REF 144TA2453 (for steel tracks) (bolt mounted)</p> <p><i>S/P: 5154 - S/N: 11001 - and up</i></p>		<p>REF 144TA2255 (number of teeth = 21) (number of holes = 12)</p>	<p>REF 144TA2291 (Ø = 416,00 mm)</p>	<p>REF 140TA8643 (400 x 72,5 x 74)</p>
<p>REF 144TA2351 (for rubber tracks) (bolt mounted) (Ø flange = 159,00 mm) (Ø body = 115,00 mm)</p> <p>REF 144TA2453 (for steel tracks) (bolt mounted)</p> <p><i>S/P: 5295 - S/N: 11001 - and up</i></p>		<p>REF 144TA2201 (number of teeth = 21) (number of holes = 12)</p>	<p>REF 144TA2291 (Ø = 416,00 mm)</p>	<p>REF 140TA8643 (400 x 72,5 x 74)</p>
<p>REF 144TA2252 (for rubber tracks) (nut mounted) (Ø flange = 159,00 mm) (Ø body = 115,00 mm)</p> <p>REF 144TA2253 (for steel tracks) (nut mounted)</p> <p>REF 144TA2351 (for rubber tracks) (bolt mounted) (Ø flange = 159,00 mm) (Ø body = 115,00 mm)</p> <p>REF 144TA2453 (for steel tracks) (bolt mounted)</p> <p><i>S/P: A00C - S/N: 11001 - and up</i></p>	<p>REF 144TA2454 (bolt mounted) (Ø flange = 119,00 mm) (Ø body = 95,50 mm)</p>	<p>REF 144TA2255 (number of teeth = 21) (number of holes = 12)</p>	<p>REF 144TA2291 (Ø = 416,00 mm)</p>	<p>REF 140TA8643 (400 x 72,5 x 74)</p>
<p>REF 144TA2252 (for rubber tracks) (nut mounted) (Ø flange = 159,00 mm) (Ø body = 115,00 mm)</p> <p>REF 144TA2253 (for steel tracks) (nut mounted)</p> <p>REF 144TA2351 (for rubber tracks) (bolt mounted) (Ø flange = 159,00 mm) (Ø body = 115,00 mm)</p> <p>REF 144TA2453 (for steel tracks) (bolt mounted)</p> <p><i>S/P: A9W7 - S/N: 11001 - and up</i></p>	<p>REF 144TA2454 (bolt mounted) (Ø flange = 119,00 mm) (Ø body = 95,50 mm)</p>	<p>REF 144TA2255 (number of teeth = 21) (number of holes = 12)</p>	<p>REF 144TA2291 (Ø = 416,00 mm)</p>	<p>REF 140TA8643 (400 x 72,5 x 74)</p>
<p>REF 144TA2252 (for rubber tracks) (nut mounted) (Ø flange = 159,00 mm) (Ø body = 115,00 mm)</p> <p>REF 144TA2204 (for rubber tracks) (nut mounted) (Ø flange = 133,00 mm) (Ø body = 95,00 mm)</p>	<p>REF 144TA2255 (number of teeth = 21) (number of holes = 12)</p>	<p>REF 144TA2291 (Ø = 416,00 mm)</p>	<p>REF 140TA8643 (400 x 72,5 x 74)</p>	



used for BOBCAT				
TRACK ROLLER	TOP ROLLER	SPROCKET	IDLER	TRACK
				
<p>REF 144TA2253 (for steel tracks) (nut mounted)</p> <p>REF 144TA2351 (for rubber tracks) (bolt mounted) (Ø flange = 159,00 mm) (Ø body = 115,00 mm)</p> <p>REF 144TA2453 (for steel tracks) (bolt mounted)</p>	<p>REF 144TA2249 (for steel tracks) (nut mounted) (Ø flange = 115,00 mm) (Ø body = 95,00 mm)</p> <p>REF 144TA2454 (bolt mounted) (Ø flange = 119,00 mm) (Ø body = 95,50 mm)</p>			
<i>S/P: A9W9 - S/N: 11001 - and up</i>				
<p>REF 144TA2252 (for rubber tracks) (nut mounted) (Ø flange = 159,00 mm) (Ø body = 115,00 mm)</p> <p>REF 144TA2253 (for steel tracks) (nut mounted)</p> <p>REF 144TA2351 (for rubber tracks) (bolt mounted) (Ø flange = 159,00 mm) (Ø body = 115,00 mm)</p> <p>REF 144TA2453 (for steel tracks) (bolt mounted)</p>	<p>REF 144TA2204 (for rubber tracks) (nut mounted) (Ø flange = 133,00 mm) (Ø body = 95,00 mm)</p> <p>REF 144TA2249 (for steel tracks) (nut mounted) (Ø flange = 115,00 mm) (Ø body = 95,00 mm)</p> <p>REF 144TA2454 (bolt mounted) (Ø flange = 119,00 mm) (Ø body = 95,50 mm)</p>	<p>REF 144TA2255 (number of teeth = 21) (number of holes = 12)</p>	<p>REF 144TA2291 (Ø = 416,00 mm)</p>	<p>REF 140TA8643 (400 x 72,5 x 74)</p>
<i>S/P: AAC8 - S/N: 11001 - and up</i>				
<p>REF 144TA2252 (for rubber tracks) (nut mounted) (Ø flange = 159,00 mm) (Ø body = 115,00 mm)</p> <p>REF 144TA2253 (for steel tracks) (nut mounted)</p> <p>REF 144TA2351 (for rubber tracks) (bolt mounted) (Ø flange = 159,00 mm) (Ø body = 115,00 mm)</p> <p>REF 144TA2453 (for steel tracks) (bolt mounted)</p>	<p>REF 144TA2204 (for rubber tracks) (nut mounted) (Ø flange = 133,00 mm) (Ø body = 95,00 mm)</p> <p>REF 144TA2249 (for steel tracks) (nut mounted) (Ø flange = 115,00 mm) (Ø body = 95,00 mm)</p> <p>REF 144TA2454 (bolt mounted) (Ø flange = 119,00 mm) (Ø body = 95,50 mm)</p>	<p>REF 144TA2255 (number of teeth = 21) (number of holes = 12)</p>	<p>REF 144TA2291 (Ø = 416,00 mm)</p>	<p>REF 140TA8643 (400 x 72,5 x 74)</p>
BOBCAT 418				
<i>S/P: AB47 - S/N: 11001 - and up</i>				
<p>REF 143TA8578</p>		<p>REF 144TA2469 (number of teeth = 12) (number of holes = 9)</p>	<p>REF 144TA2493 (Ø = 250,00 mm)</p>	<p>REF 164TA1429 (180 x 72 x 39)</p>
<i>S/P: B392 - S/N: 11001 - and up</i>				
<p>REF 143TA8578</p>		<p>REF 144TA2469 (number of teeth = 12) (number of holes = 9)</p>	<p>REF 144TA2493 (Ø = 250,00 mm)</p>	<p>REF 164TA1429 (180 x 72 x 39)</p>





used for BOBCAT				
TRACK ROLLER	TOP ROLLER	SPROCKET	IDLER	TRACK
				
BOBCAT 425				
<i>S/P: A1HW - S/N: 11001 - and up</i>				
<p>REF 144TA2349 (for rubber tracks) (bolt mounted) (∅ flange = 133,00 mm) (∅ body = 95,00 mm)</p> <p>REF 144TA2407 (for steel tracks) (bolt mounted) (∅ flange = 115,00 mm) (∅ body = 95,00 mm)</p> <p>REF 144TA2204 (for rubber tracks) (nut mounted) (∅ flange = 133,00 mm) (∅ body = 95,00 mm)</p> <p>REF 144TA2249 (for steel tracks) (nut mounted) (∅ flange = 115,00 mm) (∅ body = 95,00 mm)</p>		<p>REF 144TA2325 (number of teeth = 21) (number of holes = 12)</p>	<p>REF 144TA2495 (for rubber tracks) (∅ = 309,20 mm)</p> <p>REF 144TA2513 (for steel tracks) (∅ = 295,00 mm)</p>	<p>REF 143TA9624 (320 x 54 x 78)</p>
<i>S/P: A520 - S/N: 11001 - and up</i>				
<p>REF 144TA2349 (for rubber tracks) (bolt mounted) (∅ flange = 133,00 mm) (∅ body = 95,00 mm)</p> <p>REF 144TA2407 (for steel tracks) (bolt mounted) (∅ flange = 115,00 mm) (∅ body = 95,00 mm)</p> <p>REF 144TA2204 (for rubber tracks) (nut mounted) (∅ flange = 133,00 mm) (∅ body = 95,00 mm)</p> <p>REF 144TA2249 (for steel tracks) (nut mounted) (∅ flange = 115,00 mm) (∅ body = 95,00 mm)</p>		<p>REF 144TA2325 (number of teeth = 21) (number of holes = 12)</p>	<p>REF 144TA2495 (for rubber tracks) (∅ = 309,20 mm)</p> <p>REF 144TA2513 (for steel tracks) (∅ = 295,00 mm)</p>	<p>REF 143TA9624 (320 x 54 x 78)</p>
<i>S/P: A9K3 - S/N: 11001 - and up</i>				
<p>REF 144TA2349 (for rubber tracks) (bolt mounted) (∅ flange = 133,00 mm) (∅ body = 95,00 mm)</p> <p>REF 144TA2407 (for steel tracks) (bolt mounted) (∅ flange = 115,00 mm) (∅ body = 95,00 mm)</p> <p>REF 144TA2204 (for rubber tracks) (nut mounted) (∅ flange = 133,00 mm) (∅ body = 95,00 mm)</p> <p>REF 144TA2249 (for steel tracks) (nut mounted) (∅ flange = 115,00 mm) (∅ body = 95,00 mm)</p>		<p>REF 144TA2325 (number of teeth = 21) (number of holes = 12)</p>	<p>REF 144TA2495 (for rubber tracks) (∅ = 309,20 mm)</p> <p>REF 144TA2513 (for steel tracks) (∅ = 295,00 mm)</p>	<p>REF 143TA9624 (320 x 54 x 78)</p>
<i>S/P: A9K4 - S/N: 11001 - and up</i>				
<p>REF 144TA2349 (for rubber tracks) (bolt mounted) (∅ flange = 133,00 mm) (∅ body = 95,00 mm)</p> <p>REF 144TA2407 (for steel tracks) (bolt mounted) (∅ flange = 115,00 mm) (∅ body = 95,00 mm)</p> <p>REF 144TA2204 (for rubber tracks) (nut mounted) (∅ flange = 133,00 mm) (∅ body = 95,00 mm)</p> <p>REF 144TA2249 (for steel tracks) (nut mounted) (∅ flange = 115,00 mm) (∅ body = 95,00 mm)</p>		<p>REF 144TA2325 (number of teeth = 21) (number of holes = 12)</p>	<p>REF 144TA2495 (for rubber tracks) (∅ = 309,20 mm)</p> <p>REF 144TA2513 (for steel tracks) (∅ = 295,00 mm)</p>	<p>REF 143TA9624 (320 x 54 x 78)</p>



used for BOBCAT				
TRACK ROLLER	TOP ROLLER	SPROCKET	IDLER	TRACK
				
<i>S/P: AACJ - S/N: 11001 - and up</i>				
<p>REF 144TA2349 (for rubber tracks) (bolt mounted) (∅ flange = 133,00 mm) (∅ body = 95,00 mm)</p> <p>REF 144TA2407 (for steel tracks) (bolt mounted) (∅ flange = 115,00 mm) (∅ body = 95,00 mm)</p> <p>REF 144TA2204 (for rubber tracks) (nut mounted) (∅ flange = 133,00 mm) (∅ body = 95,00 mm)</p> <p>REF 144TA2249 (for steel tracks) (nut mounted) (∅ flange = 115,00 mm) (∅ body = 95,00 mm)</p>		<p>REF 144TA2325 (number of teeth = 21) (number of holes = 12)</p>	<p>REF 144TA2495 (for rubber tracks) (∅ = 309,20 mm)</p> <p>REF 144TA2513 (for steel tracks) (∅ = 295,00 mm)</p>	<p>REF 143TA9624 (320 x 54 x 78)</p>
BOBCAT 428				
<i>S/P: A1HW - S/N: 11001 - and up</i>				
<p>REF 144TA2204 (for rubber tracks) (nut mounted) (∅ flange = 133,00 mm) (∅ body = 95,00 mm)</p> <p>REF 144TA2249 (for steel tracks) (nut mounted) (∅ flange = 115,00 mm) (∅ body = 95,00 mm)</p> <p>REF 144TA2349 (for rubber tracks) (bolt mounted) (∅ flange = 133,00 mm) (∅ body = 95,00 mm)</p> <p>REF 144TA2407 (for steel tracks) (bolt mounted) (∅ flange = 115,00 mm) (∅ body = 95,00 mm)</p>		<p>REF 144TA2325 (number of teeth = 21) (number of holes = 12)</p>	<p>REF 144TA2495 (for rubber tracks) (∅ = 309,20 mm)</p> <p>REF 144TA2513 (for steel tracks) (∅ = 295,00 mm)</p>	<p>REF 143TA9624 (320 x 54 x 78)</p>
<i>S/P: A520 - S/N: 11001 - and up</i>				
<p>REF 144TA2204 (for rubber tracks) (nut mounted) (∅ flange = 133,00 mm) (∅ body = 95,00 mm)</p> <p>REF 144TA2249 (for steel tracks) (nut mounted) (∅ flange = 115,00 mm) (∅ body = 95,00 mm)</p> <p>REF 144TA2349 (for rubber tracks) (bolt mounted) (∅ flange = 133,00 mm) (∅ body = 95,00 mm)</p> <p>REF 144TA2407 (for steel tracks) (bolt mounted) (∅ flange = 115,00 mm) (∅ body = 95,00 mm)</p>		<p>REF 144TA2325 (number of teeth = 21) (number of holes = 12)</p>	<p>REF 144TA2495 (for rubber tracks) (∅ = 309,20 mm)</p> <p>REF 144TA2513 (for steel tracks) (∅ = 295,00 mm)</p>	<p>REF 143TA9624 (320 x 54 x 78)</p>
<i>S/P: A9K3 - S/N: 11001 - and up</i>				
<p>REF 144TA2349 (for rubber tracks) (bolt mounted) (∅ flange = 133,00 mm) (∅ body = 95,00 mm)</p> <p>REF 144TA2407 (for steel tracks) (bolt mounted) (∅ flange = 115,00 mm) (∅ body = 95,00 mm)</p> <p>REF 144TA2204 (for rubber tracks) (nut mounted) (∅ flange = 133,00 mm) (∅ body = 95,00 mm)</p> <p>REF 144TA2249 (for steel tracks) (nut mounted) (∅ flange = 115,00 mm) (∅ body = 95,00 mm)</p>		<p>REF 144TA2325 (number of teeth = 21) (number of holes = 12)</p>	<p>REF 144TA2495 (for rubber tracks) (∅ = 309,20 mm)</p> <p>REF 144TA2513 (for steel tracks) (∅ = 295,00 mm)</p>	<p>REF 143TA9624 (320 x 54 x 78)</p>



used for BOBCAT				
TRACK ROLLER	TOP ROLLER	SPROCKET	IDLER	TRACK
				
<i>S/P: A9K4 - S/N: 11001 - and up</i>				
<p>REF 144TA2349 (for rubber tracks) (bolt mounted) (Ø flange = 133,00 mm) (Ø body = 95,00 mm)</p> <p>REF 144TA2407 (for steel tracks) (bolt mounted) (Ø flange = 115,00 mm) (Ø body = 95,00 mm)</p> <p>REF 144TA2204 (for rubber tracks) (nut mounted) (Ø flange = 133,00 mm) (Ø body = 95,00 mm)</p> <p>REF 144TA2249 (for steel tracks) (nut mounted) (Ø flange = 115,00 mm) (Ø body = 95,00 mm)</p>		<p>REF 144TA2325 (number of teeth = 21) (number of holes = 12)</p>	<p>REF 144TA2495 (for rubber tracks) (Ø = 309,20 mm)</p> <p>REF 144TA2513 (for steel tracks) (Ø = 295,00 mm)</p>	<p>REF 143TA9624 (320 x 54 x 78)</p>
<i>S/P: AACJ - S/N: 11001 - and up</i>				
<p>REF 144TA2349 (for rubber tracks) (bolt mounted) (Ø flange = 133,00 mm) (Ø body = 95,00 mm)</p> <p>REF 144TA2407 (for steel tracks) (bolt mounted) (Ø flange = 115,00 mm) (Ø body = 95,00 mm)</p> <p>REF 144TA2204 (for rubber tracks) (nut mounted) (Ø flange = 133,00 mm) (Ø body = 95,00 mm)</p> <p>REF 144TA2249 (for steel tracks) (nut mounted) (Ø flange = 115,00 mm) (Ø body = 95,00 mm)</p>		<p>REF 144TA2325 (number of teeth = 21) (number of holes = 12)</p>	<p>REF 144TA2495 (for rubber tracks) (Ø = 309,20 mm)</p> <p>REF 144TA2513 (for steel tracks) (Ø = 295,00 mm)</p>	<p>REF 143TA9624 (320 x 54 x 78)</p>
BOBCAT 430				
<i>S/P: 5625 - S/N: 11001 - and up</i>				
<p>REF 144TA2349 (for rubber tracks) (bolt mounted) (Ø flange = 133,00 mm) (Ø body = 95,00 mm)</p> <p>REF 144TA2407 (for steel tracks) (bolt mounted) (Ø flange = 115,00 mm) (Ø body = 95,00 mm)</p> <p>REF 144TA2204 (for rubber tracks) (nut mounted) (Ø flange = 133,00 mm) (Ø body = 95,00 mm)</p> <p>REF 144TA2249 (for steel tracks) (nut mounted) (Ø flange = 115,00 mm) (Ø body = 95,00 mm)</p>	<p>REF 144TA2348 (bolt mounted) (Ø flange = 115,00 mm) (Ø body = 80,00 mm)</p>	<p>REF 144TA2494 (number of teeth = 23) (number of holes = 12)</p>	<p>REF 144TA2495 (for rubber tracks) (Ø = 309,20 mm)</p> <p>REF 144TA2513 (for steel tracks) (Ø = 295,00 mm)</p>	<p>REF 143TA9626 (300 x 52,5 x 92)</p>
<i>S/P: 5627 - S/N: 11001 - and up</i>				
<p>REF 144TA2349 (for rubber tracks) (bolt mounted) (Ø flange = 133,00 mm) (Ø body = 95,00 mm)</p> <p>REF 144TA2407 (for steel tracks) (bolt mounted) (Ø flange = 115,00 mm) (Ø body = 95,00 mm)</p> <p>REF 144TA2204 (for rubber tracks) (nut mounted) (Ø flange = 133,00 mm) (Ø body = 95,00 mm)</p> <p>REF 144TA2249 (for steel tracks) (nut mounted) (Ø flange = 115,00 mm) (Ø body = 95,00 mm)</p>	<p>REF 144TA2348 (bolt mounted) (Ø flange = 115,00 mm) (Ø body = 80,00 mm)</p>	<p>REF 144TA2494 (number of teeth = 23) (number of holes = 12)</p>	<p>REF 144TA2495 (for rubber tracks) (Ø = 309,20 mm)</p> <p>REF 144TA2513 (for steel tracks) (Ø = 295,00 mm)</p>	<p>REF 143TA9626 (300 x 52,5 x 92)</p>



used for BOBCAT				
TRACK ROLLER	TOP ROLLER	SPROCKET	IDLER	TRACK
				
<i>S/P: 5629 - S/N: 11001 - and up</i>				
<p>REF 144TA2349 (for rubber tracks) (bolt mounted) (Ø flange = 133,00 mm) (Ø body = 95,00 mm)</p> <p>REF 144TA2407 (for steel tracks) (bolt mounted) (Ø flange = 115,00 mm) (Ø body = 95,00 mm)</p> <p>REF 144TA2204 (for rubber tracks) (nut mounted) (Ø flange = 133,00 mm) (Ø body = 95,00 mm)</p> <p>REF 144TA2249 (for steel tracks) (nut mounted) (Ø flange = 115,00 mm) (Ø body = 95,00 mm)</p>	<p>REF 144TA2348 (bolt mounted) (Ø flange = 115,00 mm) (Ø body = 80,00 mm)</p>	<p>REF 144TA2494 (number of teeth = 23) (number of holes = 12)</p>	<p>REF 144TA2495 (for rubber tracks) (Ø = 309,20 mm)</p> <p>REF 144TA2513 (for steel tracks) (Ø = 295,00 mm)</p>	<p>REF 143TA9626 (300 x 52,5 x 92)</p>
<i>S/P: 5630 - S/N: 11001 - and up</i>				
<p>REF 144TA2349 (for rubber tracks) (bolt mounted) (Ø flange = 133,00 mm) (Ø body = 95,00 mm)</p> <p>REF 144TA2407 (for steel tracks) (bolt mounted) (Ø flange = 115,00 mm) (Ø body = 95,00 mm)</p> <p>REF 144TA2204 (for rubber tracks) (nut mounted) (Ø flange = 133,00 mm) (Ø body = 95,00 mm)</p> <p>REF 144TA2249 (for steel tracks) (nut mounted) (Ø flange = 115,00 mm) (Ø body = 95,00 mm)</p>	<p>REF 144TA2348 (bolt mounted) (Ø flange = 115,00 mm) (Ø body = 80,00 mm)</p>	<p>REF 144TA2494 (number of teeth = 23) (number of holes = 12)</p>	<p>REF 144TA2495 (for rubber tracks) (Ø = 309,20 mm)</p> <p>REF 144TA2513 (for steel tracks) (Ø = 295,00 mm)</p>	<p>REF 143TA9626 (300 x 52,5 x 92)</p>
<i>S/P: AA87 - S/N: 11001 - and up</i>				
<p>REF 144TA2349 (for rubber tracks) (bolt mounted) (Ø flange = 133,00 mm) (Ø body = 95,00 mm)</p> <p>REF 144TA2407 (for steel tracks) (bolt mounted) (Ø flange = 115,00 mm) (Ø body = 95,00 mm)</p> <p>REF 144TA2204 (for rubber tracks) (nut mounted) (Ø flange = 133,00 mm) (Ø body = 95,00 mm)</p> <p>REF 144TA2249 (for steel tracks) (nut mounted) (Ø flange = 115,00 mm) (Ø body = 95,00 mm)</p>	<p>REF 144TA2348 (bolt mounted) (Ø flange = 115,00 mm) (Ø body = 80,00 mm)</p>	<p>REF 144TA2494 (number of teeth = 23) (number of holes = 12)</p>	<p>REF 144TA2495 (for rubber tracks) (Ø = 309,20 mm)</p> <p>REF 144TA2513 (for steel tracks) (Ø = 295,00 mm)</p>	<p>REF 143TA9626 (300 x 52,5 x 92)</p>
<i>S/P: AA88 - S/N: 11001 - and up</i>				
<p>REF 144TA2349 (for rubber tracks) (bolt mounted) (Ø flange = 133,00 mm) (Ø body = 95,00 mm)</p> <p>REF 144TA2407 (for steel tracks) (bolt mounted) (Ø flange = 115,00 mm) (Ø body = 95,00 mm)</p> <p>REF 144TA2204 (for rubber tracks) (nut mounted) (Ø flange = 133,00 mm) (Ø body = 95,00 mm)</p>	<p>REF 144TA2348 (bolt mounted) (Ø flange = 115,00 mm) (Ø body = 80,00 mm)</p>	<p>REF 144TA2494 (number of teeth = 23) (number of holes = 12)</p>	<p>REF 144TA2495 (for rubber tracks) (Ø = 309,20 mm)</p> <p>REF 144TA2513 (for steel tracks) (Ø = 295,00 mm)</p>	<p>REF 143TA9626 (300 x 52,5 x 92)</p>



used for BOBCAT				
TRACK ROLLER	TOP ROLLER	SPROCKET	IDLER	TRACK
				
<p>REF 144TA2249 (for steel tracks) (nut mounted) (Ø flange = 115,00 mm) (Ø body = 95,00 mm)</p> <p><i>S/P: AACF - S/N: 11001 - and up</i></p>				
<p>REF 144TA2349 (for rubber tracks) (bolt mounted) (Ø flange = 133,00 mm) (Ø body = 95,00 mm)</p> <p>REF 144TA2407 (for steel tracks) (bolt mounted) (Ø flange = 115,00 mm) (Ø body = 95,00 mm)</p> <p>REF 144TA2204 (for rubber tracks) (nut mounted) (Ø flange = 133,00 mm) (Ø body = 95,00 mm)</p> <p>REF 144TA2249 (for steel tracks) (nut mounted) (Ø flange = 115,00 mm) (Ø body = 95,00 mm)</p>	<p>REF 144TA2348 (bolt mounted) (Ø flange = 115,00 mm) (Ø body = 80,00 mm)</p>	<p>REF 144TA2494 (number of teeth = 23) (number of holes = 12)</p>	<p>REF 144TA2495 (for rubber tracks) (Ø = 309,20 mm)</p> <p>REF 144TA2513 (for steel tracks) (Ø = 295,00 mm)</p>	<p>REF 143TA9626 (300 x 52,5 x 92)</p>
<p><i>S/P: AACG - S/N: 11001 - and up</i></p>				
<p>REF 144TA2349 (for rubber tracks) (bolt mounted) (Ø flange = 133,00 mm) (Ø body = 95,00 mm)</p> <p>REF 144TA2407 (for steel tracks) (bolt mounted) (Ø flange = 115,00 mm) (Ø body = 95,00 mm)</p> <p>REF 144TA2204 (for rubber tracks) (nut mounted) (Ø flange = 133,00 mm) (Ø body = 95,00 mm)</p> <p>REF 144TA2249 (for steel tracks) (nut mounted) (Ø flange = 115,00 mm) (Ø body = 95,00 mm)</p>	<p>REF 144TA2348 (bolt mounted) (Ø flange = 115,00 mm) (Ø body = 80,00 mm)</p>	<p>REF 144TA2494 (number of teeth = 23) (number of holes = 12)</p>	<p>REF 144TA2495 (for rubber tracks) (Ø = 309,20 mm)</p> <p>REF 144TA2513 (for steel tracks) (Ø = 295,00 mm)</p>	<p>REF 143TA9626 (300 x 52,5 x 92)</p>
<p>BOBCAT 435</p> <p><i>S/P: 5626 - S/N: 11001 - and up</i></p>				
<p>REF 144TA2252 (for rubber tracks) (nut mounted) (Ø flange = 159,00 mm) (Ø body = 115,00 mm)</p> <p>REF 144TA2253 (for steel tracks) (nut mounted)</p> <p>REF 144TA2351 (for rubber tracks) (bolt mounted) (Ø flange = 159,00 mm) (Ø body = 115,00 mm)</p> <p>REF 144TA2453 (for steel tracks) (bolt mounted)</p>	<p>REF 144TA2454 (bolt mounted) (Ø flange = 119,00 mm) (Ø body = 95,50 mm)</p>	<p>REF 144TA2255 (number of teeth = 21) (number of holes = 12)</p>	<p>REF 144TA2291 (Ø = 416,00 mm)</p>	<p>REF 140TA8643 (400 x 72,5 x 92)</p>
<p><i>S/P: 5628 - S/N: 11001 - and up</i></p>				
<p>REF 144TA2252 (for rubber tracks) (nut mounted) (Ø flange = 159,00 mm) (Ø body = 115,00 mm)</p> <p>REF 144TA2253 (for steel tracks) (nut mounted)</p> <p>REF 144TA2351 (for rubber tracks) (bolt mounted) (Ø flange = 159,00 mm) (Ø body = 115,00 mm)</p>	<p>REF 144TA2454 (bolt mounted) (Ø flange = 119,00 mm) (Ø body = 95,50 mm)</p>	<p>REF 144TA2255 (number of teeth = 21) (number of holes = 12)</p>	<p>REF 144TA2291 (Ø = 416,00 mm)</p>	<p>REF 140TA8643 (400 x 72,5 x 92)</p>



used for BOBCAT				
TRACK ROLLER	TOP ROLLER	SPROCKET	IDLER	TRACK
				
<p>REF 144TA2453 (for steel tracks) (bolt mounted) <i>S/P: 5631 - S/N: 11001 - and up</i></p>				
<p>REF 144TA2252 (for rubber tracks) (nut mounted) (Ø flange = 159,00 mm) (Ø body = 115,00 mm)</p> <p>REF 144TA2253 (for steel tracks) (nut mounted)</p> <p>REF 144TA2351 (for rubber tracks) (bolt mounted) (Ø flange = 159,00 mm) (Ø body = 115,00 mm)</p> <p>REF 144TA2453 (for steel tracks) (bolt mounted) <i>S/P: 5632 - S/N: 11001 - and up</i></p>	<p>REF 144TA2454 (bolt mounted) (Ø flange = 119,00 mm) (Ø body = 95,50 mm)</p>	<p>REF 144TA2255 (number of teeth = 21) (number of holes = 12)</p>	<p>REF 144TA2291 (Ø = 416,00 mm)</p>	<p>REF 140TA8643 (400 x 72,5 x 74)</p>
<p>REF 144TA2252 (for rubber tracks) (nut mounted) (Ø flange = 159,00 mm) (Ø body = 115,00 mm)</p> <p>REF 144TA2253 (for steel tracks) (nut mounted)</p> <p>REF 144TA2351 (for rubber tracks) (bolt mounted) (Ø flange = 159,00 mm) (Ø body = 115,00 mm)</p> <p>REF 144TA2453 (for steel tracks) (bolt mounted) <i>S/P: AA89 - S/N: 11001 - and up</i></p>	<p>REF 144TA2454 (bolt mounted) (Ø flange = 119,00 mm) (Ø body = 95,50 mm)</p>	<p>REF 144TA2255 (number of teeth = 21) (number of holes = 12)</p>	<p>REF 144TA2291 (Ø = 416,00 mm)</p>	<p>REF 140TA8643 (400 x 72,5 x 74)</p>
<p>REF 144TA2252 (for rubber tracks) (nut mounted) (Ø flange = 159,00 mm) (Ø body = 115,00 mm)</p> <p>REF 144TA2253 (for steel tracks) (nut mounted)</p> <p>REF 144TA2351 (for rubber tracks) (bolt mounted) (Ø flange = 159,00 mm) (Ø body = 115,00 mm)</p> <p>REF 144TA2453 (for steel tracks) (bolt mounted) <i>S/P: AA8A - S/N: 11001 - and up</i></p>	<p>REF 144TA2454 (bolt mounted) (Ø flange = 119,00 mm) (Ø body = 95,50 mm)</p>	<p>REF 144TA2255 (number of teeth = 21) (number of holes = 12)</p>	<p>REF 144TA2291 (Ø = 416,00 mm)</p>	<p>REF 140TA8643 (400 x 72,5 x 74)</p>
<p>REF 144TA2252 (for rubber tracks) (nut mounted) (Ø flange = 159,00 mm) (Ø body = 115,00 mm)</p> <p>REF 144TA2253 (for steel tracks) (nut mounted)</p> <p>REF 144TA2351 (for rubber tracks) (bolt mounted) (Ø flange = 159,00 mm) (Ø body = 115,00 mm)</p> <p>REF 144TA2453 (for steel tracks) (bolt mounted) <i>S/P: AACB - S/N: 11001 - and up</i></p>	<p>REF 144TA2454 (bolt mounted) (Ø flange = 119,00 mm) (Ø body = 95,50 mm)</p>	<p>REF 144TA2255 (number of teeth = 21) (number of holes = 12)</p>	<p>REF 144TA2291 (Ø = 416,00 mm)</p>	<p>REF 140TA8643 (400 x 72,5 x 74)</p>



used for BOBCAT				
TRACK ROLLER	TOP ROLLER	SPROCKET	IDLER	TRACK
				
<p>REF 144TA2253 (for steel tracks) (nut mounted)</p> <p>REF 144TA2351 (for rubber tracks) (bolt mounted) (Ø flange = 159,00 mm) (Ø body = 115,00 mm)</p> <p>REF 144TA2453 (for steel tracks) (bolt mounted)</p> <p><i>S/P: AACD - S/N: 11001 - and up</i></p>				
<p>REF 144TA2252 (for rubber tracks) (nut mounted) (Ø flange = 159,00 mm) (Ø body = 115,00 mm)</p> <p>REF 144TA2253 (for steel tracks) (nut mounted)</p> <p>REF 144TA2351 (for rubber tracks) (bolt mounted) (Ø flange = 159,00 mm) (Ø body = 115,00 mm)</p> <p>REF 144TA2453 (for steel tracks) (bolt mounted)</p>	<p>REF 144TA2454 (bolt mounted) (Ø flange = 119,00 mm) (Ø body = 95,50 mm)</p>	<p>REF 144TA2255 (number of teeth = 21) (number of holes = 12)</p>	<p>REF 144TA2291 (Ø = 416,00 mm)</p>	<p>REF 140TA8643 (400 x 72,5 x 74)</p>
BOBCAT 442				
<i>S/P: 5223 - S/N: 11001 - and up</i>				
<p>REF 144TA2316 (for rubber tracks) (inner guide roller) (Ø flange = 188,00 mm) (Ø body = 135,00 mm)</p> <p>REF 144TA2315 (for rubber and steel tracks) (outer guide roller) (Ø flange = 155,00 mm) (Ø body = 121,00 mm)</p>	<p>REF 144TA2274 (for rubber and steel tracks) (Ø flange = 115,00 mm) (Ø body = 95,00 mm)</p>	<p>REF 144TA2319 (for rubber tracks) (number of teeth = 23) (number of holes = 16)</p> <p>REF 144TA2318 (for steel tracks)</p>	<p>REF 144TA2416 (for rubber tracks)</p> <p>REF 164TA1403 (for steel tracks)</p>	<p>REF 143TA9629 (450 x 71 x 86)</p>
<i>S/P: 5286 - S/N: 11001 - and up</i>				
<p>REF 144TA2316 (for rubber tracks) (inner guide roller) (Ø flange = 188,00 mm) (Ø body = 135,00 mm)</p> <p>REF 144TA2315 (for rubber and steel tracks) (outer guide roller) (Ø flange = 155,00 mm) (Ø body = 121,00 mm)</p>	<p>REF 144TA2274 (for rubber and steel tracks) (Ø flange = 115,00 mm) (Ø body = 95,00 mm)</p>	<p>REF 144TA2319 (for rubber tracks) (number of teeth = 23) (number of holes = 16)</p> <p>REF 144TA2318 (for steel tracks)</p>	<p>REF 164TA1403 (for steel tracks)</p> <p>REF 144TA2416 (for rubber tracks)</p>	<p>REF 143TA9629 (450 x 71 x 86)</p>
<i>S/P: 5289 - S/N: 11001 - and up</i>				
<p>REF 144TA2316 (for rubber tracks) (inner guide roller) (Ø flange = 188,00 mm) (Ø body = 135,00 mm)</p> <p>REF 144TA2315 (for rubber and steel tracks) (outer guide roller) (Ø flange = 155,00 mm) (Ø body = 121,00 mm)</p>	<p>REF 144TA2274 (for rubber and steel tracks) (Ø flange = 115,00 mm) (Ø body = 95,00 mm)</p>	<p>REF 144TA2319 (for rubber tracks) (number of teeth = 23) (number of holes = 16)</p> <p>REF 144TA2318 (for steel tracks)</p>	<p>REF 144TA2416 (for rubber tracks)</p> <p>REF 164TA1403 (for steel tracks)</p>	<p>REF 143TA9629 (450 x 71 x 86)</p>
<i>S/P: ADBR - S/N: 11001 - and up</i>				
<p>REF 144TA2315 (for rubber and steel tracks) (outer guide roller) (Ø flange = 155,00 mm) (Ø body = 121,00 mm)</p> <p>REF 144TA2316 (for rubber tracks) (inner guide roller) (Ø flange = 188,00 mm) (Ø body = 135,00 mm)</p>	<p>REF 144TA2274 (for rubber and steel tracks) (Ø flange = 115,00 mm) (Ø body = 95,00 mm)</p>	<p>REF 144TA2318 (for steel tracks)</p> <p>REF 144TA2319 (for rubber tracks) (number of teeth = 23) (number of holes = 16)</p>	<p>REF 144TA2416 (for rubber tracks)</p> <p>REF 164TA1403 (for steel tracks)</p>	<p>REF 143TA9629 (450 x 71 x 86)</p>



used for BOBCAT				
TRACK ROLLER	TOP ROLLER	SPROCKET	IDLER	TRACK
				
<i>S/P: ADBS - S/N: 11001 - and up</i>				
REF 144TA2315 (for rubber and steel tracks) (outer guide roller) (Ø flange = 155,00 mm) (Ø body = 121,00 mm)	REF 144TA2274 (for rubber and steel tracks) (Ø flange = 115,00 mm) (Ø body = 95,00 mm)	REF 144TA2318 (for steel tracks)	REF 144TA2416 (for rubber tracks)	REF 143TA9629 (450 x 71 x 86)
REF 144TA2316 (for rubber tracks) (inner guide roller) (Ø flange = 188,00 mm) (Ø body = 135,00 mm)		REF 144TA2319 (for rubber tracks) (number of teeth = 23) (number of holes = 16)	REF 164TA1403 (for steel tracks)	
BOBCAT 444				
<i>S/P: 5322 - S/N: 11001 - and up</i>				
REF 144TA2217 (for rubber and steel tracks) (outer guide roller) (Ø flange = 166,00 mm) (Ø body = 137,00 mm)	REF 144TA2217 (for rubber and steel tracks) (Ø flange = 166,00 mm) (Ø body = 137,00 mm)	REF 144TA2218 (for rubber and steel tracks)	REF 144TA2216 (for rubber and steel tracks) (Ø = 510,00 mm)	REF 143TA9630 (500 x 92 x 78)
REF 144TA2304 (for rubber and steel tracks) (inner guide roller) (Ø flange = 185,00 mm) (Ø body = 130,00 mm)			REF 144TA2215 (for steel tracks)	
<i>S/P: ADBT - S/N: 11001 - and up</i>				
REF 144TA2217 (for rubber and steel tracks) (outer guide roller) (Ø flange = 166,00 mm) (Ø body = 137,00 mm)	REF 144TA2217 (for rubber and steel tracks) (Ø flange = 166,00 mm) (Ø body = 137,00 mm)	REF 144TA2218 (for rubber and steel tracks)	REF 144TA2216 (for rubber and steel tracks) (Ø = 510,00 mm)	REF 143TA9630 (500 x 92 x 78)
REF 144TA2304 (for rubber and steel tracks) (inner guide roller) (Ø flange = 185,00 mm) (Ø body = 130,00 mm)				
BOBCAT 864				
<i>S/P: 5168 - S/N: 11001 - and up</i>				
REF 144TA2305 (Ø flange = 214,00 mm) (Ø body = 200,00 mm)		REF 144TA2261 (number of teeth = 17) (number of holes = 6) (flange thickness = 17,00 mm)	REF 144TA2322 (Ø = 350,00 mm)	REF 164TA1405 (320 x 86 x 52)
		REF 144TA2344 (number of teeth = 17) (number of holes = 6) (sprocket for motor 7109868)	REF 144TA2323 (Ø = 290,00 mm)	REF 164TA1406 (450 x 86 x 52)
<i>S/P: 5169 - S/N: 11001 - and up</i>				
REF 144TA2305 (Ø flange = 214,00 mm) (Ø body = 200,00 mm)		REF 144TA2261 (number of teeth = 17) (number of holes = 6) (flange thickness = 17,00 mm)	REF 144TA2322 (Ø = 350,00 mm)	REF 164TA1405 (320 x 86 x 52)
		REF 144TA2344 (number of teeth = 17) (number of holes = 6) (sprocket for motor 7109868)	REF 144TA2323 (Ø = 290,00 mm)	REF 164TA1406 (450 x 86 x 52)
<i>S/P: 5175 - S/N: 11001 - and up</i>				
REF 144TA2305 (Ø flange = 214,00 mm) (Ø body = 200,00 mm)		REF 144TA2261 (number of teeth = 17) (number of holes = 6) (flange thickness = 17,00 mm)	REF 144TA2322 (Ø = 350,00 mm)	REF 164TA1405 (320 x 86 x 52)
		REF 144TA2344 (number of teeth = 17) (number of holes = 6) (sprocket for motor 7109868)	REF 144TA2323 (Ø = 290,00 mm)	REF 164TA1406 (450 x 86 x 52)



used for BOBCAT				
TRACK ROLLER	TOP ROLLER	SPROCKET	IDLER	TRACK
				
<i>S/P: 5189 - S/N: 11001 - and up</i>				
REF 144TA2305 (Ø flange = 214,00 mm) (Ø body = 200,00 mm)		REF 144TA2261 (number of teeth = 17) (number of holes = 6) (flange thickness = 17,00 mm) REF 144TA2344 (number of teeth = 17) (number of holes = 6) (sprocket for motor 7109868)	REF 144TA2322 (Ø = 350,00 mm) REF 144TA2323 (Ø = 290,00 mm)	REF 164TA1405 (320 x 86 x 52) REF 164TA1406 (450 x 86 x 52)
BOBCAT E08				
<i>S/P: A4BP - S/N: 11001 - and up</i>				
REF 143TA8578		REF 144TA2469 (number of teeth = 12) (number of holes = 9)	REF 144TA2493 (Ø = 250,00 mm)	REF 143TA9633 (180 x 72 x 39)
BOBCAT E10				
<i>S/P: A33P - S/N: 11001 - and up</i>				
REF 143TA8578		REF 144TA2469 (number of teeth = 12) (number of holes = 9)	REF 144TA2493 (Ø = 250,00 mm)	REF 164TA1429 (180 x 72 x 39)
BOBCAT E14				
<i>S/P: AHNM - S/N: 11001 - and up</i>				
REF 144TA2326 (Ø flange = 130,00 mm) (Ø body = 72,00 mm)		REF 143TA9023 (number of teeth = 13) (number of holes = 9)	REF 144TA2221 (Ø = 270,00 mm)	REF 143TA9623 (200 x 72 x 41)
BOBCAT E16				
<i>S/P: AHLL - S/N: 11001 - and up</i>				
REF 144TA2348 (Ø flange = 115,00 mm) (Ø body = 80,00 mm)		REF 144TA2476 (number of teeth = 19) (number of holes = 9)	REF 144TA2470 (Ø = 265,00 mm)	REF 143TA9652 (230 x 96 x 33)
BOBCAT E17				
<i>S/P: B27H - S/N: 11001 - and up</i>				
REF 144TA2348 (bolt mounted) (Ø flange = 115,00 mm) (Ø body = 80,00 mm)		REF 144TA2476 (number of teeth = 19) (number of holes = 9)	REF 164TA1432	REF 164TA1411 (230 x 48 x 66) REF 143TA9652 (230 x 96 x 33)
BOBCAT E19				
<i>S/P: AWMM - S/N: 11001 - and up</i>				
REF 144TA2348 (22,00 mm rib) (Ø flange = 115,00 mm) (Ø body = 80,00 mm)		REF 144TA2476 (number of teeth = 19) (number of holes = 9)	REF 164TA1432	REF 164TA1411 (230 x 48 x 66) REF 143TA9652 (230 x 96 x 33)
<i>S/P: B3LA - S/N: 11001 - and up</i>				
REF 144TA2348 (Ø flange = 115,00 mm) (Ø body = 80,00 mm)		REF 144TA2476 (number of teeth = 19) (number of holes = 9)	REF 164TA1432	REF 164TA1411 (230 x 48 x 66) REF 143TA9652 (230 x 96 x 33)
<i>S/P: B3LB - S/N: 11001 - and up</i>				
REF 144TA2348 (22,00 mm rib) (Ø flange = 115,00 mm) (Ø body = 80,00 mm)		REF 144TA2476 (number of teeth = 19) (number of holes = 9)	REF 164TA1432	REF 143TA9652 (230 x 96 x 33)



used for BOBCAT				
TRACK ROLLER	TOP ROLLER	SPROCKET	IDLER	TRACK
				
				REF 164TA1411 (230 x 48 x 66)
BOBCAT E20				
<i>S/P: AWRH - S/N: 11001 - and up</i>				
REF 144TA2348 (Ø flange = 115,00 mm) (Ø body = 80,00 mm)		REF 144TA2476 (number of teeth = 19) (number of holes = 9)	REF 164TA1432	REF 164TA1431 (230 x 48 x 72)
<i>S/P: B3BL - S/N: 11001 - and up</i>				
REF 144TA2348 (Ø flange = 115,00 mm) (Ø body = 80,00 mm)		REF 144TA2476 (number of teeth = 19) (number of holes = 9)	REF 164TA1432	REF 164TA1431 (230 x 48 x 72)
BOBCAT E25				
<i>S/P: AB8B - S/N: 11001 - and up</i>				
REF 144TA2349 (for rubber tracks) (bolt mounted) (Ø flange = 133,00 mm) (Ø body = 95,00 mm)	REF 164TA1422 (plate type)	REF 144TA2504 (number of teeth = 21) (number of holes = 9)	REF 144TA2508	REF 164TA1441 (250 x 52,5 x 76)
BOBCAT E26				
<i>S/P: ACRA - S/N: 11001 - and up</i>				
REF 144TA2349 (for rubber tracks) (bolt mounted) (Ø flange = 133,00 mm) (Ø body = 95,00 mm)	REF 144TA2510 (Ø body = 82,00 mm)	REF 144TA2504 (number of teeth = 21) (number of holes = 9)	REF 144TA2508	REF 164TA1409 (300 x 52,5 x 80)
REF 144TA2407 (for steel tracks) (bolt mounted) (Ø flange = 115,00 mm) (Ø body = 95,00 mm)				
<i>S/P: AJRY - S/N: 11001 - and up</i>				
REF 144TA2349 (for rubber tracks) (bolt mounted) (Ø flange = 133,00 mm) (Ø body = 95,00 mm)	REF 144TA2510 (Ø body = 82,00 mm)	REF 144TA2504 (number of teeth = 21) (number of holes = 9)	REF 144TA2508	REF 164TA1409 (300 x 52,5 x 80)
REF 144TA2407 (for steel tracks) (bolt mounted) (Ø flange = 115,00 mm) (Ø body = 95,00 mm)				
<i>S/P: B332 - S/N: 11001 - and up</i>				
REF 144TA2349 (for rubber tracks) (bolt mounted) (Ø flange = 133,00 mm) (Ø body = 95,00 mm)	REF 144TA2510 (Ø body = 82,00 mm)	REF 144TA2504 (number of teeth = 21) (number of holes = 9)	REF 144TA2508	REF 164TA1409 (300 x 52,5 x 80)
REF 144TA2407 (for steel tracks) (bolt mounted) (Ø flange = 115,00 mm) (Ø body = 95,00 mm)				
<i>S/P: B3JE - S/N: 11001 - and up</i>				
REF 144TA2349 (for rubber tracks) (bolt mounted) (Ø flange = 133,00 mm) (Ø body = 95,00 mm)	REF 144TA2507 (Ø body = 69,50 mm)	REF 144TA2504 (number of teeth = 21) (number of holes = 9)	REF 164TA1430	REF 164TA1409 (300 x 52,5 x 80)
REF 144TA2407 (for steel tracks) (bolt mounted) (Ø flange = 115,00 mm) (Ø body = 95,00 mm)				
BOBCAT E32				
<i>S/P: A94H - S/N: 11001 - and up</i>				
REF 144TA2349 (for rubber tracks) (bolt mounted) (Ø flange = 133,00 mm) (Ø body = 95,00 mm)	REF 144TA2507 (Ø body = 69,50 mm)	REF 144TA2504 (number of teeth = 21) (number of holes = 9)	REF 144TA2495 (for rubber tracks) (Ø = 309,20 mm)	REF 143TA9624 (320 x 54 x 78)
REF 144TA2407 (for steel tracks) (bolt mounted) (Ø flange = 115,00 mm) (Ø body = 95,00 mm)			REF 144TA2513 (for steel tracks) (Ø = 295,00 mm)	



used for BOBCAT				
TRACK ROLLER	TOP ROLLER	SPROCKET	IDLER	TRACK
				
<i>S/P: AC2N - S/N: 11001 - and up</i>				
REF 144TA2349 (for rubber tracks) (bolt mounted) (∅ flange = 133,00 mm) (∅ body = 95,00 mm) REF 144TA2407 (for steel tracks) (bolt mounted) (∅ flange = 115,00 mm) (∅ body = 95,00 mm)	REF 144TA2507 (∅ body = 69,50 mm)	REF 144TA2504 (number of teeth = 21) (number of holes = 9)	REF 144TA2495 (for rubber tracks) (∅ = 309,20 mm) REF 144TA2513 (for steel tracks) (∅ = 295,00 mm)	REF 143TA9624 (320 x 54 x 78)
<i>S/P: B2VV - S/N: 11001 - and up</i>				
REF 144TA2349 (for rubber tracks) (bolt mounted) (∅ flange = 133,00 mm) (∅ body = 95,00 mm) REF 144TA2407 (for steel tracks) (bolt mounted) (∅ flange = 115,00 mm) (∅ body = 95,00 mm)	REF 144TA2507 (∅ body = 69,50 mm)	REF 144TA2504 (number of teeth = 21) (number of holes = 9)	REF 144TA2495 (for rubber tracks) (∅ = 309,20 mm) REF 144TA2513 (for steel tracks) (∅ = 295,00 mm)	REF 143TA9624 (320 x 54 x 78)
<i>S/P: B3CS - S/N: 11001 - and up</i>				
REF 144TA2349 (for rubber tracks) (bolt mounted) (∅ flange = 133,00 mm) (∅ body = 95,00 mm) REF 144TA2407 (for steel tracks) (bolt mounted) (∅ flange = 115,00 mm) (∅ body = 95,00 mm)	REF 144TA2468 (∅ body = 82,00 mm)	REF 144TA2504 (number of teeth = 21) (number of holes = 9)	REF 144TA2495 (for rubber tracks) (∅ = 309,20 mm) REF 144TA2513 (for steel tracks) (∅ = 295,00 mm)	REF 143TA9624 (320 x 54 x 78)
<i>S/P: B3K9 - S/N: 11001 - and up</i>				
REF 144TA2349 (for rubber tracks) (bolt mounted) (∅ flange = 133,00 mm) (∅ body = 95,00 mm) REF 144TA2407 (for steel tracks) (bolt mounted) (∅ flange = 115,00 mm) (∅ body = 95,00 mm)	REF 144TA2468 (∅ body = 82,00 mm)	REF 144TA2504 (number of teeth = 21) (number of holes = 9)	REF 144TA2495 (for rubber tracks) (∅ = 309,20 mm) REF 144TA2513 (for steel tracks) (∅ = 295,00 mm)	REF 143TA9624 (320 x 54 x 78)
BOBCAT E32I				
<i>S/P: AUJY - S/N: 11001 - and up</i>				
REF 144TA2349 (for rubber tracks) (bolt mounted) (∅ flange = 133,00 mm) (∅ body = 95,00 mm) REF 144TA2407 (for steel tracks) (bolt mounted) (∅ flange = 115,00 mm) (∅ body = 95,00 mm)	REF 144TA2507 (∅ body = 69,50 mm)	REF 144TA2504 (number of teeth = 21) (number of holes = 9)	REF 144TA2495 (for rubber tracks) (∅ = 309,20 mm) REF 144TA2513 (for steel tracks) (∅ = 295,00 mm)	REF 164TA1402 (320 x 54 x 78)
BOBCAT E35				
<i>S/P: A93K - S/N: 11001 - and up</i>				
REF 144TA2349 (for rubber tracks) (bolt mounted) (∅ flange = 133,00 mm) (∅ body = 95,00 mm) REF 144TA2407 (for steel tracks) (bolt mounted) (∅ flange = 115,00 mm) (∅ body = 95,00 mm)	REF 144TA2507 (∅ body = 69,50 mm)	REF 144TA2504 (number of teeth = 21) (number of holes = 9)	REF 144TA2495 (for rubber tracks) (∅ = 309,20 mm) REF 144TA2513 (for steel tracks) (∅ = 295,00 mm)	REF 143TA9635 (320 x 52,5 x 84)
<i>S/P: AC2P - S/N: 11001 - and up</i>				
REF 144TA2349 (for rubber tracks) (bolt mounted) (∅ flange = 133,00 mm) (∅ body = 95,00 mm) REF 144TA2407 (for steel tracks) (bolt mounted) (∅ flange = 115,00 mm) (∅ body = 95,00 mm)	REF 144TA2507 (∅ body = 69,50 mm)	REF 144TA2504 (number of teeth = 21) (number of holes = 9)	REF 144TA2495 (for rubber tracks) (∅ = 309,20 mm) REF 144TA2513 (for steel tracks) (∅ = 295,00 mm)	REF 143TA9635 (320 x 52,5 x 84)







used for BOBCAT				
TRACK ROLLER	TOP ROLLER	SPROCKET	IDLER	TRACK
				
<i>S/P: AR1K - S/N: 11001 - and up</i>				
REF 144TA2349 (for rubber tracks) (bolt mounted) (Ø flange = 133,00 mm) (Ø body = 95,00 mm)	REF 144TA2507 (Ø body = 69,50 mm)	REF 144TA2504 (number of teeth = 21) (number of holes = 9)	REF 144TA2495 (for rubber tracks) (Ø = 309,20 mm)	REF 143TA9635 (320 x 52,5 x 84)
REF 144TA2407 (for steel tracks) (bolt mounted) (Ø flange = 115,00 mm) (Ø body = 95,00 mm)			REF 144TA2513 (for steel tracks) (Ø = 295,00 mm)	
<i>S/P: B3GR - S/N: 11001 - and up</i>				
REF 144TA2349 (for rubber tracks) (bolt mounted) (Ø flange = 133,00 mm) (Ø body = 95,00 mm)	REF 144TA2468 (Ø body = 82,00 mm)	REF 144TA2504 (number of teeth = 21) (number of holes = 9)	REF 144TA2495 (for rubber tracks) (Ø = 309,20 mm)	REF 143TA9635 (320 x 52,5 x 84)
REF 144TA2407 (for steel tracks) (bolt mounted) (Ø flange = 115,00 mm) (Ø body = 95,00 mm)			REF 144TA2513 (for steel tracks) (Ø = 295,00 mm)	
<i>S/P: B3K8 - S/N: 11001 - and up</i>				
REF 144TA2349 (for rubber tracks) (bolt mounted) (Ø flange = 133,00 mm) (Ø body = 95,00 mm)	REF 144TA2468 (Ø body = 82,00 mm)	REF 144TA2504 (number of teeth = 21) (number of holes = 9)	REF 144TA2495 (for rubber tracks) (Ø = 309,20 mm)	REF 143TA9635 (320 x 52,5 x 84)
REF 144TA2407 (for steel tracks) (bolt mounted) (Ø flange = 115,00 mm) (Ø body = 95,00 mm)			REF 144TA2513 (for steel tracks) (Ø = 295,00 mm)	
BOBCAT E35I				
<i>S/P: AUYM - S/N: 11001 - and up</i>				
REF 144TA2349 (for rubber tracks) (bolt mounted) (Ø flange = 133,00 mm) (Ø body = 95,00 mm)	REF 144TA2507 (Ø body = 69,50 mm)	REF 144TA2504 (number of teeth = 21) (number of holes = 9)	REF 144TA2495 (for rubber tracks) (Ø = 309,20 mm)	REF 143TA9635 (320 x 52,5 x 84)
REF 144TA2407 (for steel tracks) (bolt mounted) (Ø flange = 115,00 mm) (Ø body = 95,00 mm)			REF 144TA2513 (for steel tracks) (Ø = 295,00 mm)	
BOBCAT E42				
<i>S/P: AG34 - S/N: 11001 - and up</i>				
REF 144TA2349 (for rubber tracks) (bolt mounted) (Ø flange = 133,00 mm) (Ø body = 95,00 mm)	REF 144TA2507 (Ø body = 69,50 mm)	REF 144TA2494 (number of teeth = 23) (number of holes = 12)	REF 144TA2495 (for rubber tracks) (Ø = 309,20 mm)	REF 144TA9211 (320 x 54 x 90)
REF 144TA2407 (for steel tracks) (bolt mounted) (Ø flange = 115,00 mm) (Ø body = 95,00 mm)			REF 144TA2513 (for steel tracks) (Ø = 295,00 mm)	
<i>S/P: B2VW - S/N: 11001 - and up</i>				
REF 144TA2349 (for rubber tracks) (bolt mounted) (Ø flange = 133,00 mm) (Ø body = 95,00 mm)	REF 144TA2507 (Ø body = 69,50 mm)	REF 144TA2494 (number of teeth = 23) (number of holes = 12)	REF 144TA2495 (for rubber tracks) (Ø = 309,20 mm)	REF 144TA9211 (320 x 54 x 90)
REF 144TA2407 (for steel tracks) (bolt mounted) (Ø flange = 115,00 mm) (Ø body = 95,00 mm)			REF 144TA2513 (for steel tracks) (Ø = 295,00 mm)	
BOBCAT E45				
<i>S/P: AG3G - S/N: 11001 - 12397</i>				
REF 144TA2351 (for rubber tracks) (bolt mounted) (Ø flange = 159,00 mm) (Ø body = 115,00 mm)	REF 144TA2468 (Ø body = 82,00 mm)	REF 144TA2511 (number of teeth = 19) (number of holes = 12)	REF 144TA2512	REF 140TA8643 (400 x 72,5 x 74)
REF 144TA2453 (for steel tracks) (bolt mounted)				







used for BOBCAT				
TRACK ROLLER	TOP ROLLER	SPROCKET	IDLER	TRACK
				
<i>S/P: AG3G - S/N: 12398 - and up</i>				
REF 144TA2351 (for rubber tracks) (bolt mounted) (∅ flange = 159,00 mm) (∅ body = 115,00 mm)	REF 144TA2468 (∅ body = 82,00 mm)	REF 144TA2511 (number of teeth = 19) (number of holes = 12)	REF 144TA2514	REF 140TA8643 (400 x 72,5 x 74)
REF 144TA2453 (for steel tracks) (bolt mounted)				
<i>S/P: AHHC - S/N: 11001 - 12435</i>				
REF 144TA2351 (for rubber tracks) (bolt mounted) (∅ flange = 159,00 mm) (∅ body = 115,00 mm)	REF 144TA2468 (∅ body = 82,00 mm)	REF 144TA2511 (number of teeth = 19) (number of holes = 12)	REF 144TA2512	REF 140TA8643 (400 x 72,5 x 74)
REF 144TA2453 (for steel tracks) (bolt mounted)				
<i>S/P: AHHC - S/N: 12436 - and up</i>				
REF 144TA2351 (for rubber tracks) (bolt mounted) (∅ flange = 159,00 mm) (∅ body = 115,00 mm)	REF 144TA2468 (∅ body = 82,00 mm)	REF 144TA2511 (number of teeth = 19) (number of holes = 12)	REF 144TA2514	REF 140TA8643 (400 x 72,5 x 74)
REF 144TA2453 (for steel tracks) (bolt mounted)				
<i>S/P: B2VY - S/N: 11001 - and up</i>				
REF 144TA2351 (for rubber tracks) (bolt mounted) (∅ flange = 159,00 mm) (∅ body = 115,00 mm)	REF 144TA2468 (∅ body = 82,00 mm)	REF 144TA2511 (number of teeth = 19) (number of holes = 12)	REF 144TA2514	REF 140TA8643 (400 x 72,5 x 74)
REF 144TA2453 (for steel tracks) (bolt mounted)				
<i>S/P: B3NM - S/N: 11001 - and up</i>				
REF 144TA2351 (for rubber tracks) (bolt mounted) (∅ flange = 159,00 mm) (∅ body = 115,00 mm)	REF 144TA2468 (∅ body = 82,00 mm)	REF 144TA2511 (number of teeth = 19) (number of holes = 12)	REF 144TA2514	REF 140TA8643 (400 x 72,5 x 74)
REF 144TA2453 (for steel tracks) (bolt mounted)				
<i>S/P: B3NR - S/N: 11001 - and up</i>				
REF 144TA2351 (for rubber tracks) (bolt mounted) (∅ flange = 159,00 mm) (∅ body = 115,00 mm)	REF 144TA2468 (∅ body = 82,00 mm)	REF 144TA2511 (number of teeth = 19) (number of holes = 12)	REF 144TA2514	REF 140TA8643 (400 x 72,5 x 74)
REF 144TA2453 (for steel tracks) (bolt mounted)				
BOBCAT E50				
<i>S/P: AG3N - S/N: 11001 - 12434</i>				
REF 144TA2351 (for rubber tracks) (bolt mounted) (∅ flange = 159,00 mm) (∅ body = 115,00 mm)	REF 144TA2468 (∅ body = 82,00 mm)	REF 144TA2511 (number of teeth = 19) (number of holes = 12)	REF 144TA2512 (for rubber tracks)	REF 140TA8643 (400 x 72,5 x 74)
REF 144TA2453 (for steel tracks) (bolt mounted)				
<i>S/P: AG3N - S/N: 12435 - and up</i>				
REF 144TA2351 (for rubber tracks) (bolt mounted) (∅ flange = 159,00 mm) (∅ body = 115,00 mm)	REF 144TA2468 (∅ body = 82,00 mm)	REF 144TA2511 (number of teeth = 19) (number of holes = 12)	REF 144TA2514 (for steel tracks)	REF 140TA8643 (400 x 72,5 x 74)
REF 144TA2453 (for steel tracks) (bolt mounted)				
<i>S/P: AHHE - S/N: 11001 - 12535</i>				
REF 144TA2351 (for rubber tracks) (bolt mounted) (∅ flange = 159,00 mm) (∅ body = 115,00 mm)	REF 144TA2468 (∅ body = 82,00 mm)	REF 144TA2511 (number of teeth = 19) (number of holes = 12)	REF 144TA2512 (for rubber tracks)	REF 140TA8643 (400 x 72,5 x 74)



used for BOBCAT				
TRACK ROLLER	TOP ROLLER	SPROCKET	IDLER	TRACK
				
REF 144TA2453 (for steel tracks) (bolt mounted) <i>S/P: AHHE - S/N: 12536 - and up</i>				
REF 144TA2351 (for rubber tracks) (bolt mounted) (Ø flange = 159,00 mm) (Ø body = 115,00 mm)	REF 144TA2468 (Ø body = 82,00 mm)	REF 144TA2511 (number of teeth = 19) (number of holes = 12)	REF 144TA2514 (for steel tracks)	REF 140TA8643 (400 x 72,5 x 74)
REF 144TA2453 (for steel tracks) (bolt mounted) <i>S/P: AJ18 - S/N: 11001 - and up</i>				
REF 144TA2351 (for rubber tracks) (bolt mounted) (Ø flange = 159,00 mm) (Ø body = 115,00 mm)	REF 144TA2468 (Ø body = 82,00 mm)	REF 144TA2511 (number of teeth = 19) (number of holes = 12)	REF 144TA2514	REF 140TA8643 (400 x 72,5 x 74)
REF 144TA2453 (for steel tracks) (bolt mounted) <i>S/P: B3NN - S/N: 11001 - and up</i>				
REF 144TA2351 (for rubber tracks) (bolt mounted) (Ø flange = 159,00 mm) (Ø body = 115,00 mm)	REF 144TA2468 (Ø body = 82,00 mm)	REF 144TA2511 (number of teeth = 19) (number of holes = 12)	REF 144TA2514	REF 140TA8643 (400 x 72,5 x 74)
REF 144TA2453 (for steel tracks) (bolt mounted) <i>S/P: B3NS - S/N: 11001 - and up</i>				
REF 144TA2351 (for rubber tracks) (bolt mounted) (Ø flange = 159,00 mm) (Ø body = 115,00 mm)	REF 144TA2468 (Ø body = 82,00 mm)	REF 144TA2511 (number of teeth = 19) (number of holes = 12)	REF 144TA2514	REF 140TA8643 (400 x 72,5 x 74)
REF 144TA2453 (for steel tracks) (bolt mounted) <i>S/P: B3NS - S/N: 11001 - and up</i>				
BOBCAT E55				
<i>S/P: AJ19 - S/N: 11001 - and up</i>				
REF 144TA2351 (for rubber tracks) (bolt mounted) (Ø flange = 159,00 mm) (Ø body = 115,00 mm)	REF 144TA2468 (Ø body = 82,00 mm)	REF 144TA2511 (number of teeth = 19) (number of holes = 12)	REF 144TA2514	REF 140TA8643 (400 x 72,5 x 74)
REF 144TA2453 (for steel tracks) (bolt mounted) <i>S/P: ARWM - S/N: 11001 - 11263</i>				
REF 144TA2351 (for rubber tracks) (bolt mounted) (Ø flange = 159,00 mm) (Ø body = 115,00 mm)	REF 144TA2468 (Ø body = 82,00 mm)	REF 144TA2511 (number of teeth = 19) (number of holes = 12)	REF 144TA2512	REF 140TA8643 (400 x 72,5 x 74)
REF 144TA2453 (for steel tracks) (bolt mounted) <i>S/P: ARWM - S/N: 11264 - and up</i>				
REF 144TA2351 (for rubber tracks) (bolt mounted) (Ø flange = 159,00 mm) (Ø body = 115,00 mm)	REF 144TA2468 (Ø body = 82,00 mm)	REF 144TA2511 (number of teeth = 19) (number of holes = 12)	REF 144TA2514	REF 140TA8643 (400 x 72,5 x 74)
REF 144TA2453 (for steel tracks) (bolt mounted) <i>S/P: ASW3 - S/N: 11001 - 11422</i>				
REF 144TA2351 (for rubber tracks) (bolt mounted) (Ø flange = 159,00 mm) (Ø body = 115,00 mm)	REF 144TA2468 (Ø body = 82,00 mm)	REF 144TA2511 (number of teeth = 19) (number of holes = 12)	REF 144TA2512	REF 140TA8643 (400 x 72,5 x 74)
REF 144TA2453 (for steel tracks) (bolt mounted)				



used for BOBCAT				
TRACK ROLLER	TOP ROLLER	SPROCKET	IDLER	TRACK
				
<i>S/P: ASW3 - S/N: 11423 - and up</i>				
REF 144TA2351 (for rubber tracks) (bolt mounted) (∅ flange = 159,00 mm) (∅ body = 115,00 mm)	REF 144TA2468 (∅ body = 82,00 mm)	REF 144TA2511 (number of teeth = 19) (number of holes = 12)	REF 144TA2514	REF 140TA8643 (400 x 72,5 x 74)
REF 144TA2453 (for steel tracks) (bolt mounted)				
<i>S/P: B3NP - S/N: 11001 - and up</i>				
REF 144TA2351 (for rubber tracks) (bolt mounted) (∅ flange = 159,00 mm) (∅ body = 115,00 mm)	REF 144TA2468 (∅ body = 82,00 mm)	REF 144TA2511 (number of teeth = 19) (number of holes = 12)	REF 144TA2514	REF 140TA8643 (400 x 72,5 x 74)
REF 144TA2453 (for steel tracks) (bolt mounted)				
<i>S/P: B3NT - S/N: 11001 - and up</i>				
REF 144TA2351 (for rubber tracks) (bolt mounted) (∅ flange = 159,00 mm) (∅ body = 115,00 mm)	REF 144TA2468 (∅ body = 82,00 mm)	REF 144TA2511 (number of teeth = 19) (number of holes = 12)	REF 144TA2514	REF 140TA8643 (400 x 72,5 x 74)
REF 144TA2453 (for steel tracks) (bolt mounted)				
BOBCAT E60				
<i>S/P: AET8 - S/N: 11001 - 11347</i>				
REF 144TA2434 (for rubber tracks)	REF 144TA2432	REF 164TA1436		REF 164TA1410 (400 x 72,5w x 76)
REF 164TA1440 (for steel tracks)				
<i>S/P: AET8 - S/N: 11348 - and up</i>				
REF 144TA2463 (for rubber tracks)	REF 144TA2432	REF 164TA1436	REF 144TA2461 (for rubber tracks)	REF 164TA1410 (400 x 72,5w x 76)
REF 164TA1440 (for steel tracks)				
<i>S/P: AGSZ - S/N: 11001 - 11347</i>				
REF 144TA2434 (for rubber tracks)	REF 144TA2432	REF 164TA1436		REF 164TA1410 (400 x 72,5w x 76)
REF 164TA1440 (for steel tracks)				
<i>S/P: AGSZ - S/N: 11348 - and up</i>				
REF 144TA2463 (for rubber tracks)	REF 144TA2432	REF 164TA1436	REF 144TA2461 (for rubber tracks)	REF 164TA1410 (400 x 72,5w x 76)
REF 164TA1440 (for steel tracks)			REF 164TA1418 (for steel tracks)	
BOBCAT E62				
<i>S/P: B34P - S/N: 11001 - and up</i>				
REF 144TA2463	REF 144TA2432	REF 164TA1436	REF 144TA2461	REF 164TA1421 (400 x 72,5 x 76)
BOBCAT E63				
<i>S/P: B34R - S/N: 11001 - and up</i>				
REF 144TA2463	REF 144TA2432	REF 164TA1436	REF 144TA2461	REF 164TA1421 (400 x 72,5 x 76)
BOBCAT E80				
<i>S/P: AET3 - S/N: 11001 - 12910</i>				
REF 144TA2433 (for rubber tracks)	REF 144TA2349 (∅ flange = 133,00 mm) (∅ body = 95,00 mm)	REF 164TA1438 (for rubber tracks)	REF 144TA2517 (for rubber tracks)	REF 143TA9638 (450 x 81w x 76)



used for BOBCAT				
TRACK ROLLER	TOP ROLLER	SPROCKET	IDLER	TRACK
				
REF 164TA1414 (for steel tracks)		REF 164TA1412 (for steel tracks) (number of teeth = 21) (number of holes = 12)	REF 164TA1413 (for steel tracks)	
<i>S/P: AET3 - S/N: 12911 - and up</i>				
REF 144TA2433 (for rubber tracks)	REF 144TA2349 (Ø flange = 133,00 mm) (Ø body = 95,00 mm)	REF 164TA1438 (for rubber tracks)	REF 144TA2517 (for rubber tracks)	REF 143TA9638 (450 x 81w x 76)
REF 164TA1414 (for steel tracks)		REF 164TA1439 (for steel tracks)	REF 164TA1413 (for steel tracks)	
<i>S/P: AETB - S/N: 11001 - 12910</i>				
REF 144TA2433 (for rubber tracks)	REF 144TA2349 (Ø flange = 133,00 mm) (Ø body = 95,00 mm)	REF 164TA1438 (for rubber tracks)	REF 144TA2517 (for rubber tracks)	REF 143TA9638 (450 x 81w x 76)
REF 164TA1414 (for steel tracks)		REF 164TA1412 (for steel tracks) (number of teeth = 21) (number of holes = 12)	REF 164TA1413 (for steel tracks)	
<i>S/P: AETB - S/N: 12911 - and up</i>				
REF 144TA2433 (for rubber tracks)	REF 144TA2349 (Ø flange = 133,00 mm) (Ø body = 95,00 mm)	REF 164TA1438 (for rubber tracks)	REF 144TA2517 (for rubber tracks)	REF 143TA9638 (450 x 81w x 76)
REF 164TA1414 (for steel tracks)		REF 164TA1439 (for steel tracks)	REF 164TA1413 (for steel tracks)	
BOBCAT E85				
<i>S/P: B34S - S/N: 11001 - and up</i>				
REF 144TA2433	REF 144TA2349 (Ø flange = 133,00 mm) (Ø body = 95,00 mm)	REF 164TA1438	REF 144TA2517	REF 164TA1420 (450 x 81 x 76)
<i>S/P: B34T - S/N: 11001 - and up</i>				
REF 144TA2433	REF 144TA2349 (Ø flange = 133,00 mm) (Ø body = 95,00 mm)	REF 164TA1438	REF 144TA2517	REF 164TA1420 (450 x 81 x 76)
BOBCAT MT50				
<i>S/P: 5206 - S/N: 11001 - and up</i>				
REF 144TA2327		REF 144TA2265	REF 144TA2466 (Ø = 256,50 mm)	REF 143TA9633 (180 x 72 x 39)
<i>S/P: 5224 - S/N: 11001 - and up</i>				
REF 144TA2327		REF 144TA2265	REF 144TA2466 (Ø = 256,50 mm)	REF 143TA9633 (180 x 72 x 39)
BOBCAT MT52				
<i>S/P: 5236 - S/N: 11001 - and up</i>				
REF 144TA2327		REF 144TA2266 (number of teeth = 8)	REF 144TA2466 (Ø = 256,50 mm)	REF 143TA9633 (180 x 72 x 39)
<i>S/P: 5237 - S/N: 11001 - and up</i>				
REF 144TA2327		REF 144TA2266 (number of teeth = 8)	REF 144TA2466 (Ø = 256,50 mm)	REF 143TA9633 (180 x 72 x 39)
<i>S/P: 5287 - S/N: 11001 - and up</i>				
REF 144TA2327		REF 144TA2266 (number of teeth = 8)	REF 144TA2466 (Ø = 256,50 mm)	REF 143TA9633 (180 x 72 x 39)
<i>S/P: 5288 - S/N: 11001 - and up</i>				
REF 144TA2327		REF 144TA2266 (number of teeth = 8)	REF 144TA2466 (Ø = 256,50 mm)	REF 143TA9633 (180 x 72 x 39)



used for BOBCAT

used for BOBCAT				
TRACK ROLLER	TOP ROLLER	SPROCKET	IDLER	TRACK
				
<i>S/P: A3WR - S/N: 11001 - and up</i>				
REF 144TA2327		REF 144TA2266 (number of teeth = 8)	REF 144TA2466 (Ø = 256,50 mm)	REF 143TA9633 (180 x 72 x 39)
<i>S/P: A3WS - S/N: 11001 - and up</i>				
REF 144TA2327		REF 144TA2266 (number of teeth = 8)	REF 144TA2466 (Ø = 256,50 mm)	REF 143TA9633 (180 x 72 x 39)
<i>S/P: B38R - S/N: 11001 - and up</i>				
REF 144TA2327		REF 144TA2266 (number of teeth = 8)	REF 144TA2466 (Ø = 256,50 mm)	REF 143TA9633 (180 x 72 x 39)
BOBCAT MT55				
<i>S/P: 5387 - S/N: 11001 - and up</i>				
REF 144TA2327		REF 144TA2266 (number of teeth = 8)	REF 144TA2466 (Ø = 256,50 mm)	REF 144TA2524 (180 x 72 x 39) REF 164TA1416 (250 x 72 x 39)
<i>S/P: 5388 - S/N: 11001 - and up</i>				
REF 144TA2327		REF 144TA2266 (number of teeth = 8)	REF 144TA2466 (Ø = 256,50 mm)	REF 144TA2524 (180 x 72 x 39) REF 164TA1416 (250 x 72 x 39)
<i>S/P: A3WT - S/N: 11001 - and up</i>				
REF 144TA2327		REF 144TA2266 (number of teeth = 8)	REF 144TA2466 (Ø = 256,50 mm)	REF 144TA2524 (180 x 72 x 39) REF 164TA1416 (250 x 72 x 39)
<i>S/P: A3WU - S/N: 11001 - and up</i>				
REF 144TA2327		REF 144TA2266 (number of teeth = 8)	REF 144TA2466 (Ø = 256,50 mm)	REF 144TA2524 (180 x 72 x 39) REF 164TA1416 (250 x 72 x 39)
<i>S/P: B38T - S/N: 11001 - and up</i>				
REF 144TA2327		REF 144TA2266 (number of teeth = 8)	REF 144TA2466 (Ø = 256,50 mm)	REF 144TA2524 (180 x 72 x 39) REF 164TA1416 (250 x 72 x 39)
<i>S/P: B38U - S/N: 11001 - and up</i>				
REF 144TA2327		REF 144TA2266 (number of teeth = 8)	REF 144TA2466 (Ø = 256,50 mm)	REF 144TA2524 (180 x 72 x 39) REF 164TA1416 (250 x 72 x 39)
BOBCAT MT85				
<i>S/P: B3TR - S/N: 11001 - and up</i>				
REF 144TA2327 (double guide)		REF 164TA1435	REF 144TA2466 (Ø = 256,50 mm)	REF 164TA1433 (180 x 72 x 45) REF 164TA1434 (width = 250,00 mm)
REF 164TA1437 (outer guide)				
BOBCAT T110				
<i>S/P: AE0H - S/N: 11001 - and up</i>				
REF 144TA2465		REF 144TA2467 (number of teeth = 13)	REF 144TA2464	REF 164TA1407 (250 x 72 x 52)
<i>S/P: AE0J - S/N: 11001 - and up</i>				
REF 144TA2465		REF 144TA2467 (number of teeth = 13)	REF 144TA2464	REF 164TA1407 (250 x 72 x 52)



used for BOBCAT				
TRACK ROLLER	TOP ROLLER	SPROCKET	IDLER	TRACK
				
BOBCAT T140				
<i>S/P: 5271 - S/N: 11001 - and up</i>				
REF 144TA2305 (Ø flange = 214,00 mm) (Ø body = 200,00 mm)		REF 144TA2350 (number of teeth = 15) (number of holes = 6)	REF 144TA2322 (Ø = 350,00 mm) REF 144TA2323 (Ø = 290,00 mm)	REF 143TA9642 (320 x 84 x 46)
<i>S/P: 5272 - S/N: 11001 - and up</i>				
REF 144TA2305 (Ø flange = 214,00 mm) (Ø body = 200,00 mm)		REF 144TA2350 (number of teeth = 15) (number of holes = 6)	REF 144TA2322 (Ø = 350,00 mm) REF 144TA2323 (Ø = 290,00 mm)	REF 143TA9642 (320 x 84 x 46)
<i>S/P: 5293 - S/N: 11001 - and up</i>				
REF 144TA2305 (Ø flange = 214,00 mm) (Ø body = 200,00 mm)		REF 144TA2350 (number of teeth = 15) (number of holes = 6)	REF 144TA2322 (Ø = 350,00 mm) REF 144TA2323 (Ø = 290,00 mm)	REF 143TA9642 (320 x 84 x 46)
<i>S/P: 5313 - S/N: 11001 - and up</i>				
REF 144TA2305 (Ø flange = 214,00 mm) (Ø body = 200,00 mm)		REF 144TA2350 (number of teeth = 15) (number of holes = 6)	REF 144TA2322 (Ø = 350,00 mm) REF 144TA2323 (Ø = 290,00 mm)	REF 143TA9642 (320 x 84 x 46)
<i>S/P: A3L7 - S/N: 11001 - and up</i>				
REF 144TA2305 (Ø flange = 214,00 mm) (Ø body = 200,00 mm)		REF 144TA2350 (number of teeth = 15) (number of holes = 6)	REF 144TA2322 (Ø = 350,00 mm) REF 144TA2323 (Ø = 290,00 mm)	REF 143TA9642 (320 x 84 x 46)
<i>S/P: A3L8 - S/N: 11001 - and up</i>				
REF 144TA2305 (Ø flange = 214,00 mm) (Ø body = 200,00 mm)		REF 144TA2350 (number of teeth = 15) (number of holes = 6)	REF 144TA2322 (Ø = 350,00 mm) REF 144TA2323 (Ø = 290,00 mm)	REF 143TA9642 (320 x 84 x 46)
<i>S/P: A8M5 - S/N: 11001 - and up</i>				
REF 144TA2305 (Ø flange = 214,00 mm) (Ø body = 200,00 mm)		REF 144TA2350 (number of teeth = 15) (number of holes = 6)	REF 144TA2322 (Ø = 350,00 mm) REF 144TA2323 (Ø = 290,00 mm)	REF 143TA9642 (320 x 84 x 46)
BOBCAT T180				
<i>S/P: 5242 - S/N: 11001 - and up</i>				
REF 144TA2305 (Ø flange = 214,00 mm) (Ø body = 200,00 mm)		REF 144TA2301 (number of teeth = 15) (number of holes = 6) (flange thickness = 18,00 mm) REF 144TA2350 (number of teeth = 15) (number of holes = 6) (flange thickness = 16,00 mm)	REF 144TA2322 (Ø = 350,00 mm) REF 144TA2323 (Ø = 290,00 mm)	REF 143TA9643 (320 x 86 x 49) REF 144TA9212 (400 x 86 x 49)



used for BOBCAT				
TRACK ROLLER	TOP ROLLER	SPROCKET	IDLER	TRACK
    				
<i>S/P: 5275 - S/N: 11001 - 13043</i>				
REF 144TA2305 (∅ flange = 214,00 mm) (∅ body = 200,00 mm)		REF 144TA2350 (number of teeth = 15) (number of holes = 6) (flange thickness = 16,00 mm)	REF 144TA2322 (∅ = 350,00 mm) REF 144TA2323 (∅ = 290,00 mm)	REF 143TA9643 (320 x 86 x 49) REF 144TA9212 (400 x 86 x 49)
<i>S/P: 5275 - S/N: 13044 - and up</i>				
		REF 144TA2350 (number of teeth = 15) (number of holes = 6) (flange thickness = 16,00 mm) REF 144TA2301 (number of teeth = 15) (number of holes = 6) (flange thickness = 18,00 mm)	REF 144TA2322 (∅ = 350,00 mm) REF 144TA2323 (∅ = 290,00 mm)	REF 143TA9643 (320 x 86 x 49) REF 144TA9212 (400 x 86 x 49)
<i>S/P: 5276 - S/N: 11001 - 13010</i>				
REF 144TA2305 (∅ flange = 214,00 mm) (∅ body = 200,00 mm)		REF 144TA2350 (number of teeth = 15) (number of holes = 6) (flange thickness = 16,00 mm)	REF 144TA2322 (∅ = 350,00 mm) REF 144TA2323 (∅ = 290,00 mm)	REF 143TA9643 (320 x 86 x 49) REF 144TA9212 (400 x 86 x 49)
<i>S/P: 5276 - S/N: 13010 - and up</i>				
		REF 144TA2350 (number of teeth = 15) (number of holes = 6) (flange thickness = 16,00 mm) REF 144TA2301 (number of teeth = 15) (number of holes = 6) (flange thickness = 18,00 mm)	REF 144TA2322 (∅ = 350,00 mm) REF 144TA2323 (∅ = 290,00 mm)	REF 143TA9643 (320 x 86 x 49) REF 144TA9212 (400 x 86 x 49)
<i>S/P: 5314 - S/N: 11001 - and up</i>				
REF 144TA2305 (∅ flange = 214,00 mm) (∅ body = 200,00 mm)		REF 144TA2350 (number of teeth = 15) (number of holes = 6) (flange thickness = 16,00 mm)	REF 144TA2322 (∅ = 350,00 mm) REF 144TA2323 (∅ = 290,00 mm)	REF 143TA9643 (320 x 86 x 49) REF 144TA9212 (400 x 86 x 49)
<i>S/P: 5315 - S/N: 11001 - and up</i>				
REF 144TA2305 (∅ flange = 214,00 mm) (∅ body = 200,00 mm)		REF 144TA2350 (number of teeth = 15) (number of holes = 6) (flange thickness = 16,00 mm)	REF 144TA2322 (∅ = 350,00 mm) REF 144TA2323 (∅ = 290,00 mm)	REF 143TA9643 (320 x 86 x 49) REF 144TA9212 (400 x 86 x 49)
<i>S/P: A3LL - S/N: 11001 - 36499</i>				
REF 144TA2305 (solid mounted undercarriage) (∅ flange = 214,00 mm) (∅ body = 200,00 mm)		REF 144TA2350 (number of teeth = 15) (number of holes = 6) (solid mounted) (suspension undercarriage)	REF 144TA2322 (∅ = 350,00 mm) REF 144TA2323 (solid mounted undercarriage) (∅ = 290,00 mm)	REF 143TA9643 (320 x 86 x 49) REF 144TA9212 (400 x 86 x 49)
REF 144TA2324 (roller suspension undercarriage)				



used for BOBCAT				
TRACK ROLLER	TOP ROLLER	SPROCKET	IDLER	TRACK
				
			REF 144TA2409 (roller suspension undercarriage)	
<i>S/P: A3LL - S/N: 36500 - and up</i>				
REF 144TA2305 (solid mounted undercarriage) (Ø flange = 214,00 mm) (Ø body = 200,00 mm)		REF 143TA9035 (solid mounted) (suspension undercarriage) (number of teeth = 15) (number of holes = 12)	REF 144TA2322 (Ø = 350,00 mm)	REF 143TA9643 (320 x 86 x 49)
REF 144TA2324 (roller suspension undercarriage)			REF 144TA2323 (solid mounted undercarriage) (Ø = 290,00 mm)	REF 144TA9212 (400 x 86 x 49)
			REF 144TA2409 (roller suspension undercarriage)	
BOBCAT T190				
<i>S/P: 5193 - S/N: 11001 - and up</i>				
REF 144TA2305 (Ø flange = 214,00 mm) (Ø body = 200,00 mm)		REF 144TA2301 (number of teeth = 15) (number of holes = 6) (flange thickness = 18,00 mm)	REF 144TA2322 (Ø = 350,00 mm)	REF 143TA9644 (320 x 84 x 50)
		REF 144TA2350 (number of teeth = 15) (number of holes = 6) (flange thickness = 16,00 mm)	REF 144TA2323 (Ø = 290,00 mm)	
<i>S/P: 5194 - S/N: 11001 - and up</i>				
REF 144TA2305 (Ø flange = 214,00 mm) (Ø body = 200,00 mm)		REF 144TA2301 (number of teeth = 15) (number of holes = 6) (flange thickness = 18,00 mm)	REF 144TA2322 (Ø = 350,00 mm)	REF 143TA9644 (320 x 84 x 50)
		REF 144TA2350 (number of teeth = 15) (number of holes = 6) (flange thickness = 16,00 mm)	REF 144TA2323 (Ø = 290,00 mm)	
<i>S/P: 5270 - S/N: 11001 - and up</i>				
REF 144TA2305 (Ø flange = 214,00 mm) (Ø body = 200,00 mm)		REF 144TA2301 (number of teeth = 15) (number of holes = 6) (flange thickness = 18,00 mm)	REF 144TA2322 (Ø = 350,00 mm)	REF 143TA9644 (320 x 84 x 50)
		REF 144TA2350 (number of teeth = 15) (number of holes = 6) (flange thickness = 16,00 mm)	REF 144TA2323 (Ø = 290,00 mm)	
<i>S/P: 5277 - S/N: 11001 - 13881</i>				
REF 144TA2305 (Ø flange = 214,00 mm) (Ø body = 200,00 mm)		REF 144TA2301 (number of teeth = 15) (number of holes = 6) (flange thickness = 18,00 mm)	REF 144TA2322 (Ø = 350,00 mm)	REF 143TA9644 (320 x 84 x 50)
			REF 144TA2323 (Ø = 290,00 mm)	
<i>S/P: 5277 - S/N: 13882 - and up</i>				
REF 144TA2305 (Ø flange = 214,00 mm) (Ø body = 200,00 mm)		REF 144TA2350 (number of teeth = 15) (number of holes = 6) (flange thickness = 16,00 mm)	REF 144TA2322 (Ø = 350,00 mm)	REF 143TA9644 (320 x 84 x 50)



used for BOBCAT				
TRACK ROLLER	TOP ROLLER	SPROCKET	IDLER	TRACK
				
S/P: 5278 - S/N: 11001 - 13043			REF 144TA2323 (Ø = 290,00 mm)	
REF 144TA2305 (Ø flange = 214,00 mm) (Ø body = 200,00 mm)		REF 144TA2301 (number of teeth = 15) (number of holes = 6) (flange thickness = 18,00 mm)	REF 144TA2322 (Ø = 350,00 mm) REF 144TA2323 (Ø = 290,00 mm)	REF 143TA9644 (320 x 84 x 50)
S/P: 5278 - S/N: 13044 - and up				
REF 144TA2305 (Ø flange = 214,00 mm) (Ø body = 200,00 mm)		REF 144TA2350 (number of teeth = 15) (number of holes = 6) (flange thickness = 16,00 mm)	REF 144TA2322 (Ø = 350,00 mm) REF 144TA2323 (Ø = 290,00 mm)	REF 143TA9644 (320 x 84 x 50)
S/P: 5279 - S/N: 11001 - and up				
REF 144TA2305 (Ø flange = 214,00 mm) (Ø body = 200,00 mm)		REF 144TA2301 (number of teeth = 15) (number of holes = 6) (flange thickness = 18,00 mm) REF 144TA2350 (number of teeth = 15) (number of holes = 6) (flange thickness = 16,00 mm)	REF 144TA2322 (Ø = 350,00 mm) REF 144TA2323 (Ø = 290,00 mm)	REF 143TA9644 (320 x 84 x 50)
S/P: 5316 - S/N: 11001 - and up				
REF 144TA2305 (Ø flange = 214,00 mm) (Ø body = 200,00 mm)		REF 144TA2350 (number of teeth = 15) (number of holes = 6) (flange thickness = 16,00 mm)	REF 144TA2322 (Ø = 350,00 mm) REF 144TA2323 (Ø = 290,00 mm)	REF 143TA9644 (320 x 84 x 50)
S/P: 5317 - S/N: 11001 - and up				
REF 144TA2305 (Ø flange = 214,00 mm) (Ø body = 200,00 mm)		REF 144TA2350 (number of teeth = 15) (number of holes = 6) (flange thickness = 16,00 mm)	REF 144TA2322 (Ø = 350,00 mm) REF 144TA2323 (Ø = 290,00 mm)	REF 143TA9644 (320 x 84 x 50)
S/P: A3LN - S/N: 11001 - 36499				
REF 144TA2305 (solid mounted undercarriage) (Ø flange = 214,00 mm) (Ø body = 200,00 mm) REF 144TA2324 (roller suspension undercarriage)		REF 144TA2350 (number of teeth = 15) (number of holes = 6) (solid mounted) (suspension undercarriage)	REF 144TA2322 (Ø = 350,00 mm) REF 144TA2323 (solid mounted undercarriage) (Ø = 290,00 mm) REF 144TA2409 (roller suspension undercarriage)	REF 143TA9644 (320 x 84 x 50)







used for BOBCAT				
TRACK ROLLER	TOP ROLLER	SPROCKET	IDLER	TRACK
				
<i>S/P: A3LN - S/N: 36500 - and up</i>				
<p>REF 144TA2305 (solid mounted undercarriage) (Ø flange = 214,00 mm) (Ø body = 200,00 mm)</p> <p>REF 144TA2324 (roller suspension undercarriage)</p>		<p>REF 143TA9035 (solid mounted) (suspension undercarriage) (number of teeth = 15) (number of holes = 12)</p>	<p>REF 144TA2322 (Ø = 350,00 mm)</p> <p>REF 144TA2323 (solid mounted undercarriage) (Ø = 290,00 mm)</p> <p>REF 144TA2409 (roller suspension undercarriage)</p>	<p>REF 143TA9644 (320 x 84 x 50)</p>
<i>S/P: A3LP - S/N: 11001 - 36499</i>				
<p>REF 144TA2305 (solid mounted undercarriage) (Ø flange = 214,00 mm) (Ø body = 200,00 mm)</p>		<p>REF 144TA2350 (number of teeth = 15) (number of holes = 6) (solid mounted) (suspension undercarriage)</p>	<p>REF 144TA2322 (Ø = 350,00 mm)</p> <p>REF 144TA2323 (solid mounted undercarriage) (Ø = 290,00 mm)</p> <p>REF 144TA2409 (roller suspension undercarriage)</p>	<p>REF 143TA9644 (320 x 84 x 50)</p>
<i>S/P: A3LP - S/N: 36500 - and up</i>				
<p>REF 144TA2324 (roller suspension undercarriage)</p>		<p>REF 143TA9035 (solid mounted) (suspension undercarriage) (number of teeth = 15) (number of holes = 12)</p>	<p>REF 144TA2322 (Ø = 350,00 mm)</p> <p>REF 144TA2323 (solid mounted undercarriage) (Ø = 290,00 mm)</p> <p>REF 144TA2409 (roller suspension undercarriage)</p>	<p>REF 143TA9644 (320 x 84 x 50)</p>
BOBCAT T200				
<i>S/P: 5168 - S/N: 11001 - and up</i>				
<p>REF 144TA2305 (Ø flange = 214,00 mm) (Ø body = 200,00 mm)</p>		<p>REF 144TA2261 (number of teeth = 17) (number of holes = 6) (flange thickness = 17,00 mm)</p> <p>REF 144TA2344 (number of teeth = 17) (number of holes = 6) (for motor 7109868)</p>	<p>REF 144TA2322 (Ø = 350,00 mm)</p> <p>REF 144TA2323 (Ø = 290,00 mm)</p>	<p>REF 143TA9645 (320 x 86 x 52)</p> <p>REF 143TA9646 (450 x 86 x 52)</p>
<i>S/P: 5175 - S/N: 11001 - and up</i>				
<p>REF 144TA2305 (Ø flange = 214,00 mm) (Ø body = 200,00 mm)</p>		<p>REF 144TA2261 (number of teeth = 17) (number of holes = 6) (flange thickness = 17,00 mm)</p> <p>REF 144TA2344 (number of teeth = 17) (number of holes = 6) (sprocket for motor 7109868)</p>	<p>REF 144TA2322 (Ø = 350,00 mm)</p> <p>REF 144TA2323 (Ø = 290,00 mm)</p>	<p>REF 143TA9645 (320 x 86 x 52)</p> <p>REF 143TA9646 (450 x 86 x 52)</p>



used for BOBCAT				
TRACK ROLLER	TOP ROLLER	SPROCKET	IDLER	TRACK
				
<i>S/P: 5189 - S/N: 11001 - and up</i>				
REF 144TA2305 (Ø flange = 214,00 mm) (Ø body = 200,00 mm)		REF 144TA2261 (number of teeth = 17) (number of holes = 6) (flange thickness = 17,00 mm) REF 144TA2344 (number of teeth = 17) (number of holes = 6) (sprocket for motor 7109868)	REF 144TA2322 (Ø = 350,00 mm) REF 144TA2323 (Ø = 290,00 mm)	REF 143TA9645 (320 x 86 x 52) REF 143TA9646 (450 x 86 x 52)
BOBCAT T250				
<i>S/P: 5230 - S/N: 11001 - and up</i>				
REF 144TA2305 (Ø flange = 214,00 mm) (Ø body = 200,00 mm)		REF 144TA2261 (number of teeth = 17) (number of holes = 6) (flange thickness = 17,00 mm) REF 144TA2344 (number of teeth = 17) (number of holes = 6) (flange thickness = 17,00 mm)	REF 144TA2322 (front, with bracket assembly) (Ø = 350,00 mm) REF 144TA2323 (rear, with bracket assembly) (Ø = 290,00 mm)	REF 144TA2178 (320 x 86 x 55) REF 143TA9647 (450 x 86 x 55)
<i>S/P: 5231 - S/N: 11001 - and up</i>				
REF 144TA2305 (Ø flange = 214,00 mm) (Ø body = 200,00 mm)		REF 144TA2261 (number of teeth = 17) (number of holes = 6) (flange thickness = 17,00 mm) REF 144TA2344 (number of teeth = 17) (number of holes = 6) (flange thickness = 17,00 mm)	REF 144TA2322 (front, with bracket assembly) (Ø = 350,00 mm) REF 144TA2323 (rear, with bracket assembly) (Ø = 290,00 mm)	REF 144TA2178 (320 x 86 x 55) REF 143TA9647 (450 x 86 x 55)
<i>S/P: 5256 - S/N: 11001 - and up</i>				
REF 144TA2305 (Ø flange = 214,00 mm) (Ø body = 200,00 mm)		REF 144TA2261 (number of teeth = 17) (number of holes = 6) (flange thickness = 17,00 mm) REF 144TA2344 (number of teeth = 17) (number of holes = 6) (flange thickness = 17,00 mm)	REF 144TA2322 (front, with bracket assembly) (Ø = 350,00 mm) REF 144TA2323 (rear, with bracket assembly) (Ø = 290,00 mm)	REF 144TA2178 (320 x 86 x 55) REF 143TA9647 (450 x 86 x 55)
<i>S/P: 5257 - S/N: 11001 - and up</i>				
REF 144TA2305 (Ø flange = 214,00 mm) (Ø body = 200,00 mm)		REF 144TA2261 (number of teeth = 17) (number of holes = 6) (flange thickness = 17,00 mm) REF 144TA2344 (number of teeth = 17) (number of holes = 6) (flange thickness = 17,00 mm)	REF 144TA2322 (front, with bracket assembly) (Ø = 350,00 mm) REF 144TA2323 (rear, with bracket assembly) (Ø = 290,00 mm)	REF 144TA2178 (320 x 86 x 55) REF 143TA9647 (450 x 86 x 55)
<i>S/P: 5318 - S/N: 11001 - and up</i>				
REF 144TA2305 (Ø flange = 214,00 mm) (Ø body = 200,00 mm)		REF 144TA2344 (number of teeth = 17) (number of holes = 6) (flange thickness = 17,00 mm)	REF 144TA2322 (front, with bracket assembly) (Ø = 350,00 mm) REF 144TA2323 (rear, with bracket assembly) (Ø = 290,00 mm)	REF 144TA2178 (320 x 86 x 55) REF 143TA9647 (450 x 86 x 55)



used for BOBCAT				
TRACK ROLLER	TOP ROLLER	SPROCKET	IDLER	TRACK
				
<i>S/P: 5319 - S/N: 11001 - and up</i>				
<p>REF 144TA2305 (Ø flange = 214,00 mm) (Ø body = 200,00 mm)</p>		<p>REF 144TA2344 (number of teeth = 17) (number of holes = 6) (flange thickness = 17,00 mm)</p>	<p>REF 144TA2322 (front, with bracket assembly) (Ø = 350,00 mm)</p> <p>REF 144TA2323 (rear, with bracket assembly) (Ø = 290,00 mm)</p>	<p>REF 144TA2178 (320 x 86 x 55)</p> <p>REF 143TA9647 (450 x 86 x 55)</p>
<i>S/P: A5GS - S/N: 11001 - and up</i>				
<p>REF 144TA2324 (for rubber tracks) (roller suspension track frame)</p> <p>REF 144TA2305 (for rubber tracks) (solid mount track frame) (Ø flange = 214,00 mm) (Ø body = 200,00 mm)</p> <p>REF 164TA1417 (for steel tracks)</p>		<p>REF 144TA2344 (for rubber tracks) (number of teeth = 17) (number of holes = 6) (flange thickness = 17,00 mm)</p> <p>REF 144TA2443 (for steel tracks)</p>	<p>REF 144TA2322 (front, with bracket assembly) (for rubber tracks) (Ø = 350,00 mm)</p> <p>REF 164TA1415 (front and rear, with bracket assembly) (for steel tracks)</p> <p>REF 144TA2323 (rear, with bracket assembly) (for rubber tracks) (solid mount track frame) (Ø = 290,00 mm)</p> <p>REF 144TA2409 (rear, with bracket assembly) (for rubber tracks) (roller suspension track frame)</p>	<p>REF 144TA2178 (rubber) (320 x 86 x 55)</p> <p>REF 143TA9647 (rubber) (450 x 86 x 55)</p>
<i>S/P: A5GT - S/N: 11001 - and up</i>				
<p>REF 144TA2324 (for rubber tracks) (roller suspension track frame)</p> <p>REF 144TA2305 (for rubber tracks) (solid mount track frame) (Ø flange = 214,00 mm) (Ø body = 200,00 mm)</p> <p>REF 164TA1417 (for steel tracks)</p>		<p>REF 144TA2344 (for rubber tracks) (number of teeth = 17) (number of holes = 6) (flange thickness = 17,00 mm)</p> <p>REF 144TA2443 (for steel tracks)</p>	<p>REF 144TA2322 (front, with bracket assembly) (for rubber tracks) (Ø = 350,00 mm)</p> <p>REF 164TA1415 (front and rear, with bracket assembly) (for steel tracks)</p> <p>REF 144TA2323 (rear, with bracket assembly) (for rubber tracks) (solid mount track frame) (Ø = 290,00 mm)</p> <p>REF 144TA2409 (rear, with bracket assembly) (for rubber tracks) (roller suspension track frame)</p>	<p>REF 144TA2178 (rubber) (320 x 86 x 55)</p> <p>REF 143TA9647 (rubber) (450 x 86 x 55)</p>
BOBCAT T300				
<i>S/P: 5219 - S/N: 11001 - and up</i>				
<p>REF 144TA2305 (Ø flange = 214,00 mm) (Ø body = 200,00 mm)</p>		<p>REF 144TA2261 (number of teeth = 17) (number of holes = 6) (flange thickness = 17,00 mm)</p> <p>REF 144TA2344 (number of teeth = 17) (number of holes = 6) (flange thickness = 17,00 mm)</p>	<p>REF 144TA2322 (front, with bracket assembly) (Ø = 350,00 mm)</p> <p>REF 144TA2323 (rear, with bracket assembly) (Ø = 290,00 mm)</p>	<p>REF 144TA2178 (rubber) (320 x 86 x 55)</p> <p>REF 143TA9647 (rubber) (450 x 86 x 55)</p>







used for BOBCAT				
TRACK ROLLER	TOP ROLLER	SPROCKET	IDLER	TRACK
<i>S/P: 5220 - S/N: 11001 - and up</i>				
REF 144TA2305 (Ø flange = 214,00 mm) (Ø body = 200,00 mm)		REF 144TA2261 (number of teeth = 17) (number of holes = 6) (flange thickness = 17,00 mm) REF 144TA2344 (number of teeth = 17) (number of holes = 6) (flange thickness = 17,00 mm)	REF 144TA2322 (front, with bracket assembly) (Ø = 350,00 mm) REF 144TA2323 (rear, with bracket assembly) (Ø = 290,00 mm)	REF 144TA2178 (rubber) (320 x 86 x 55) REF 143TA9647 (rubber) (450 x 86 x 55)
<i>S/P: 5254 - S/N: 11001 - and up</i>				
REF 144TA2305 (Ø flange = 214,00 mm) (Ø body = 200,00 mm)		REF 144TA2344 (number of teeth = 17) (number of holes = 6) (flange thickness = 17,00 mm) REF 144TA2261 (number of teeth = 17) (number of holes = 6) (flange thickness = 17,00 mm)	REF 144TA2322 (front, with bracket assembly) (Ø = 350,00 mm) REF 144TA2323 (rear, with bracket assembly) (Ø = 290,00 mm)	REF 144TA2178 (rubber) (320 x 86 x 55) REF 143TA9647 (rubber) (450 x 86 x 55)
<i>S/P: 5255 - S/N: 11001 - 12120</i>				
REF 144TA2305 (Ø flange = 214,00 mm) (Ø body = 200,00 mm)		REF 144TA2261 (number of teeth = 17) (number of holes = 6) (flange thickness = 17,00 mm)	REF 144TA2322 (front, with bracket assembly) (Ø = 350,00 mm) REF 144TA2323 (rear, with bracket assembly) (Ø = 290,00 mm)	REF 144TA2178 (rubber) (320 x 86 x 55) REF 143TA9647 (rubber) (450 x 86 x 55)
<i>S/P: 5255 - S/N: 12121 - and up</i>				
REF 144TA2305 (Ø flange = 214,00 mm) (Ø body = 200,00 mm)		REF 144TA2344 (number of teeth = 17) (number of holes = 6) (flange thickness = 17,00 mm)	REF 144TA2322 (front, with bracket assembly) (Ø = 350,00 mm) REF 144TA2323 (rear, with bracket assembly) (Ø = 290,00 mm)	REF 144TA2178 (rubber) (320 x 86 x 55) REF 143TA9647 (rubber) (450 x 86 x 55)
<i>S/P: 5320 - S/N: 11001 - and up</i>				
REF 144TA2305 (Ø flange = 214,00 mm) (Ø body = 200,00 mm)		REF 144TA2344 (number of teeth = 17) (number of holes = 6) (flange thickness = 17,00 mm)	REF 144TA2322 (front, with bracket assembly) (Ø = 350,00 mm) REF 144TA2323 (rear, with bracket assembly) (Ø = 290,00 mm)	REF 144TA2178 (rubber) (320 x 86 x 55) REF 143TA9647 (rubber) (450 x 86 x 55)
<i>S/P: 5321 - S/N: 11001 - and up</i>				
REF 144TA2305 (Ø flange = 214,00 mm) (Ø body = 200,00 mm)		REF 144TA2344 (number of teeth = 17) (number of holes = 6) (flange thickness = 17,00 mm)	REF 144TA2322 (front, with bracket assembly) (Ø = 350,00 mm) REF 144TA2323 (rear, with bracket assembly) (Ø = 290,00 mm)	REF 144TA2178 (rubber) (320 x 86 x 55) REF 143TA9647 (rubber) (450 x 86 x 55)







used for BOBCAT				
TRACK ROLLER	TOP ROLLER	SPROCKET	IDLER	TRACK
				
<i>S/P: A5GU - S/N: 11001 - and up</i>				
<p>REF 144TA2324 (for rubber tracks) (roller suspension track frame)</p> <p>REF 144TA2305 (for rubber tracks) (solid mount track frame) (Ø flange = 214,00 mm) (Ø body = 200,00 mm)</p> <p>REF 164TA1417 (for steel tracks)</p>		<p>REF 144TA2344 (for rubber tracks) (number of teeth = 17) (number of holes = 6) (flange thickness = 17,00 mm)</p> <p>REF 144TA2443 (for steel tracks)</p>	<p>REF 144TA2322 (front, with bracket assembly) (for rubber tracks) (Ø = 350,00 mm)</p> <p>REF 164TA1415 (front and rear, with bracket assembly) (for steel tracks)</p> <p>REF 144TA2323 (rear, with bracket assembly) (for rubber tracks) (solid mount track frame) (Ø = 290,00 mm)</p> <p>REF 144TA2409 (rear, with bracket assembly) (for rubber tracks) (roller suspension track frame)</p>	<p>REF 144TA2178 (rubber) (320 x 86 x 55)</p> <p>REF 143TA9647 (rubber) (450 x 86 x 55)</p>
<i>S/P: A5GV - S/N: 11001 - and up</i>				
<p>REF 144TA2324 (for rubber tracks) (roller suspension track frame)</p> <p>REF 144TA2305 (for rubber tracks) (solid mount track frame) (Ø flange = 214,00 mm) (Ø body = 200,00 mm)</p> <p>REF 164TA1417 (for steel tracks)</p>		<p>REF 144TA2344 (for rubber tracks) (number of teeth = 17) (number of holes = 6) (flange thickness = 17,00 mm)</p> <p>REF 144TA2443 (for steel tracks)</p>	<p>REF 144TA2322 (front, with bracket assembly) (for rubber tracks) (Ø = 350,00 mm)</p> <p>REF 164TA1415 (front and rear, with bracket assembly) (for steel tracks)</p> <p>REF 144TA2323 (rear, with bracket assembly) (for rubber tracks) (solid mount track frame)</p> <p>REF 144TA2409 (rear, with bracket assembly) (for rubber tracks) (roller suspension track frame)</p>	<p>REF 144TA2178 (rubber) (320 x 86 x 55)</p> <p>REF 143TA9647 (rubber) (450 x 86 x 55)</p>
BOBCAT T320				
<i>S/P: A7MP - S/N: 11001 - and up</i>				
<p>REF 144TA2324 (for rubber tracks) (roller suspension track frame)</p> <p>REF 144TA2305 (for rubber tracks) (solid mount track frame) (Ø flange = 214,00 mm) (Ø body = 200,00 mm)</p> <p>REF 164TA1417 (for steel tracks)</p>		<p>REF 144TA2344 (for rubber tracks) (number of teeth = 17) (number of holes = 6) (flange thickness = 17,00 mm)</p> <p>REF 144TA2443 (for steel tracks)</p>	<p>REF 144TA2322 (front, with bracket assembly) (for rubber tracks) (Ø = 350,00 mm)</p> <p>REF 164TA1415 (front and rear, with bracket assembly) (for steel tracks)</p> <p>REF 144TA2323 (rear, with bracket assembly) (for rubber tracks) (solid mount track frame)</p> <p>REF 144TA2409 (rear, with bracket assembly) (for rubber tracks) (roller suspension track frame)</p>	<p>REF 143TA9647 (rubber) (450 x 86 x 55)</p>







used for BOBCAT				
TRACK ROLLER	TOP ROLLER	SPROCKET	IDLER	TRACK
				
BOBCAT T450				
<i>S/P: AUVP - S/N: 11001 - and up</i>				
REF 144TA2570		REF 144TA2569	REF 144TA2571 (front, with bracket assembly) REF 144TA2572 (rear, with bracket assembly)	REF 143TA9642 (rubber) (320 x 84 x 46)
<i>S/P: B1EM - S/N: 11001 - and up</i>				
REF 144TA2570		REF 144TA2569	REF 144TA2571 (front, with bracket assembly) REF 144TA2572 (rear, with bracket assembly)	REF 143TA9642 (rubber) (320 x 84 x 46)
BOBCAT T550				
<i>S/P: A7UJ - S/N: 11001 - and up</i>				
REF 144TA2305 (solid mount track frame) (Ø flange = 214,00 mm) (Ø body = 200,00 mm) REF 144TA2324 (roller suspension track frame)		REF 143TA9035 (number of teeth = 15) (number of holes = 12)	REF 144TA2322 (front, with bracket assembly) (Ø = 350,00 mm) REF 144TA2323 (rear, with bracket assembly) (solid mount track frame) (Ø = 290,00 mm) REF 144TA2409 (rear, with bracket assembly) (roller suspension track frame)	REF 143TA9643 (rubber) (320 x 86 x 49) (c-tread) REF 144TA9212 (rubber) (400 x 86 x 49) (c-tread)
<i>S/P: AJZV - S/N: 11001 - 13999</i>				
REF 144TA2305 (solid mount track frame) (Ø flange = 214,00 mm) (Ø body = 200,00 mm) REF 144TA2324 (suspension track frame)			REF 144TA2322 (front, with bracket assembly) (Ø = 350,00 mm) REF 144TA2323 (rear, with bracket assembly) (solid mount track frame) (Ø = 290,00 mm) REF 144TA2409 (rear, with bracket assembly) (suspension track frame)	REF 143TA9643 (rubber) (320 x 86 x 49) (c-tread) REF 144TA9212 (rubber) (400 x 86 x 49) (c-tread)
<i>S/P: AJZV - S/N: 11001 - 14999</i>				
		REF 143TA9035 (solid mounted) (suspension undercarriage) (number of teeth = 15) (number of holes = 12)		REF 143TA9643 (rubber) (320 x 86 x 49) (c-tread) REF 144TA9212 (rubber) (400 x 86 x 49) (c-tread)
<i>S/P: AJZV - S/N: 14001 - and up</i>				
REF 164TA1423 (solid mount track frame) REF 164TA1425 (suspension track frame)			REF 164TA1424 (front, with bracket assembly) REF 164TA1426 (rear, with bracket assembly)	REF 143TA9643 (rubber) (320 x 86 x 49) (c-tread) REF 144TA9212 (rubber) (400 x 86 x 49) (c-tread)
<i>S/P: AJZV - S/N: 15001 - and up</i>				
		REF 144TA2569 (suspension track frame) (solid mount)		REF 143TA9643 (rubber) (320 x 86 x 49) (c-tread)



used for BOBCAT				
TRACK ROLLER	TOP ROLLER	SPROCKET	IDLER	TRACK
				
				REF 144TA9212 (rubber) (400 x 86 x 49) (c-tread)
BOBCAT T590				
<i>S/P: A3NR - S/N: 11001 - 15598</i>				
REF 144TA2305 (solid mount track frame) (Ø flange = 214,00 mm) (Ø body = 200,00 mm) REF 144TA2324 (suspension track frame)		REF 143TA9035 (number of teeth = 15) (number of holes = 12)	REF 144TA2322 (front, with bracket assembly) (Ø = 350,00 mm) REF 144TA2323 (rear, with bracket assembly) (solid mount track frame) (Ø = 290,00 mm) REF 144TA2409 (rear, with bracket assembly) (roller suspension track frame)	REF 143TA9643 (rubber) (320 x 86 x 49) (c-tread) REF 144TA9212 (rubber) (400 x 86 x 49) (c-tread)
<i>S/P: A3NR - S/N: 15599 - and up</i>				
REF 164TA1423 (solid mount track frame) REF 164TA1425 (suspension track frame)		REF 144TA2569	REF 164TA1424 (front, with bracket assembly) REF 164TA1426 (rear, with bracket assembly)	REF 143TA9643 (rubber) (320 x 86 x 49) (c-tread) REF 144TA9212 (rubber) (400 x 86 x 49) (c-tread)
<i>S/P: A3NS - S/N: 11001 - 11999</i>				
REF 144TA2305 (solid mount track frame) (Ø flange = 214,00 mm) (Ø body = 200,00 mm) REF 144TA2324 (suspension track frame)		REF 143TA9035 (number of teeth = 15) (number of holes = 12)	REF 144TA2322 (front, with bracket assembly) (Ø = 350,00 mm) REF 144TA2323 (rear, with bracket assembly) (solid mount track frame) (Ø = 290,00 mm) REF 144TA2409 (rear, with bracket assembly) (roller suspension track frame)	REF 143TA9643 (rubber) (320 x 86 x 49) (c-tread) REF 144TA9212 (rubber) (400 x 86 x 49) (c-tread)
<i>S/P: A3NS - S/N: 12001 - and up</i>				
REF 164TA1423 (solid mount track frame) REF 164TA1425 (suspension track frame)		REF 144TA2569	REF 164TA1424 (front, with bracket assembly) REF 164TA1426 (rear, with bracket assembly)	REF 143TA9643 (rubber) (320 x 86 x 49) (c-tread) REF 144TA9212 (rubber) (400 x 86 x 49) (c-tread)
<i>S/P: ALJU - S/N: 11001 - 16824</i>				
REF 144TA2305 (solid mount track frame) (Ø flange = 214,00 mm) (Ø body = 200,00 mm) REF 144TA2324 (suspension track frame)		REF 143TA9035 (number of teeth = 15) (number of holes = 12)	REF 144TA2322 (front, with bracket assembly) (Ø = 350,00 mm) REF 144TA2323 (rear, with bracket assembly) (solid mount track frame) (Ø = 290,00 mm) REF 144TA2409 (rear, with bracket assembly) (roller suspension track frame)	REF 143TA9643 (rubber) (320 x 86 x 49) (c-tread) REF 144TA9212 (rubber) (400 x 86 x 49) (c-tread)
<i>S/P: ALJU - S/N: 16825 - and up</i>				
REF 164TA1423 (solid mount track frame)		REF 144TA2569	REF 164TA1424 (front, with bracket assembly)	REF 143TA9643 (rubber) (320 x 86 x 49) (c-tread)





used for BOBCAT				
TRACK ROLLER	TOP ROLLER	SPROCKET	IDLER	TRACK
				
REF 164TA1425 (suspension track frame)			REF 164TA1426 (rear, with bracket assembly)	REF 144TA9212 (rubber) (400 x 86 x 49) (c-tread)
<i>S/P: B378 - S/N: 11001 - 11103</i>				
REF 144TA2305 (solid mount track frame) (Ø flange = 214,00 mm) (Ø body = 200,00 mm)		REF 143TA9035 (number of teeth = 15) (number of holes = 12)	REF 144TA2322 (front, with bracket assembly) (Ø = 350,00 mm)	REF 143TA9643 (rubber) (320 x 86 x 49) (c-tread)
REF 144TA2324 (suspension track frame)			REF 144TA2323 (rear, with bracket assembly) (solid mount track frame) (Ø = 290,00 mm)	REF 144TA9212 (rubber) (400 x 86 x 49) (c-tread)
			REF 144TA2409 (rear, with bracket assembly) (roller suspension track frame)	
<i>S/P: B378 - S/N: 11104 - and up</i>				
REF 164TA1423 (solid mount track frame)		REF 144TA2569	REF 164TA1424 (front, with bracket assembly)	REF 143TA9643 (rubber) (320 x 86 x 49) (c-tread)
REF 164TA1425 (suspension track frame)			REF 164TA1426 (rear, with bracket assembly)	REF 144TA9212 (rubber) (400 x 86 x 49) (c-tread)
<i>S/P: B3Z7 - S/N: 11001 - and up</i>				
REF 164TA1423 (solid mount track frame)		REF 144TA2569	REF 164TA1424 (front, with bracket assembly)	REF 143TA9643 (rubber) (320 x 86 x 49) (c-tread)
REF 164TA1425 (suspension track frame)			REF 164TA1426 (rear, with bracket assembly)	REF 144TA9212 (rubber) (400 x 86 x 49) (c-tread)
<i>S/P: B3ZA - S/N: 11001 - and up</i>				
REF 164TA1423 (solid mount track frame)		REF 144TA2569	REF 164TA1424 (front, with bracket assembly)	REF 143TA9643 (rubber) (320 x 86 x 49) (c-tread)
REF 164TA1425 (suspension track frame)			REF 164TA1426 (rear, with bracket assembly)	REF 144TA9212 (rubber) (400 x 86 x 49) (c-tread)
BOBCAT T630				
<i>S/P: A7PU - S/N: 11001 - 14999</i>				
REF 144TA2305 (solid mount track frame) (Ø flange = 214,00 mm) (Ø body = 200,00 mm)		REF 143TA9037 (number of teeth = 17) (number of holes = 8) (dual speed)	REF 144TA2322 (front, with bracket assembly) (Ø = 350,00 mm)	REF 164TA1405 (rubber) (320 x 86 x 52)
REF 144TA2324 (suspension track frame)		REF 144TA2344 (number of teeth = 17) (number of holes = 6) (single speed)	REF 144TA2323 (rear, with bracket assembly) (solid mount track frame) (Ø = 290,00 mm)	REF 164TA1406 (rubber) (450 x 86 x 52)
			REF 144TA2409 (rear, with bracket assembly) (roller suspension track frame)	
<i>S/P: A7PU - S/N: 15001 - and up</i>				
REF 164TA1423 (solid mount track frame)		REF 143TA9037 (number of teeth = 17) (number of holes = 8) (dual speed)	REF 164TA1427 (front, with bracket assembly)	REF 164TA1405 (rubber) (320 x 86 x 52)





used for BOBCAT				
TRACK ROLLER	TOP ROLLER	SPROCKET	IDLER	TRACK
				
REF 164TA1428 (suspension track frame)		REF 144TA2344 (number of teeth = 17) (number of holes = 6) (single speed)	REF 164TA1426 (rear, with bracket assembly)	REF 164TA1406 (rubber) (450 x 86 x 52)
<i>S/P: AJDT - S/N: 11001 - 12999</i>				
REF 144TA2305 (solid mount track frame) (Ø flange = 214,00 mm) (Ø body = 200,00 mm)		REF 143TA9037 (number of teeth = 17) (number of holes = 8) (dual speed)	REF 144TA2322 (front, with bracket assembly) (Ø = 350,00 mm)	REF 164TA1405 (rubber) (320 x 86 x 52)
REF 144TA2324 (suspension track frame)		REF 144TA2344 (number of teeth = 17) (number of holes = 6) (single speed)	REF 144TA2323 (rear, with bracket assembly) (solid mount track frame) (Ø = 290,00 mm) REF 144TA2409 (rear, with bracket assembly) (roller suspension track frame)	REF 164TA1406 (rubber) (450 x 86 x 52)
<i>S/P: AJDT - S/N: 13001 - and up</i>				
REF 164TA1423 (solid mount track frame)		REF 143TA9037 (number of teeth = 17) (number of holes = 8) (dual speed)	REF 164TA1427 (front, with bracket assembly)	REF 164TA1405 (rubber) (320 x 86 x 52)
REF 164TA1428 (suspension track frame)		REF 144TA2344 (number of teeth = 17) (number of holes = 6) (single speed)	REF 164TA1426 (rear, with bracket assembly)	REF 164TA1406 (rubber) (450 x 86 x 52)
BOBCAT T650				
<i>S/P: 1MLT - S/N: 11001 - and up</i>				
REF 144TA2305 (solid mount track frame) (Ø flange = 214,00 mm) (Ø body = 200,00 mm)		REF 143TA9037 (number of teeth = 17) (number of holes = 8) (dual speed)	REF 144TA2322 (front, with bracket assembly) (Ø = 350,00 mm)	REF 164TA1405 (rubber) (320 x 86 x 52)
REF 144TA2324 (suspension track frame)		REF 144TA2344 (number of teeth = 17) (number of holes = 6) (single speed)	REF 144TA2323 (rear, with bracket assembly) (solid mount track frame) (Ø = 290,00 mm) REF 144TA2409 (rear, with bracket assembly) (roller suspension track frame)	REF 164TA1406 (rubber) (450 x 86 x 52)
<i>S/P: A3P0 - S/N: 11001 - 13999</i>				
REF 144TA2305 (solid mount track frame) (Ø flange = 214,00 mm) (Ø body = 200,00 mm)		REF 143TA9037 (number of teeth = 17) (number of holes = 8) (dual speed)	REF 144TA2409 (rear, with bracket assembly) (roller suspension track frame)	REF 164TA1405 (rubber) (320 x 86 x 52)
REF 144TA2324 (suspension track frame)		REF 144TA2344 (number of teeth = 17) (number of holes = 6) (single speed)	REF 144TA2322 (front, with bracket assembly) (Ø = 350,00 mm) REF 144TA2323 (rear, with bracket assembly) (solid mount track frame) (Ø = 290,00 mm)	REF 164TA1406 (rubber) (450 x 86 x 52)



used for BOBCAT				
TRACK ROLLER	TOP ROLLER	SPROCKET	IDLER	TRACK
				
<i>S/P: A3P0 - S/N: 11001 - 19999</i>				
<p>REF 144TA2305 (solid mount track frame) (Ø flange = 214,00 mm) (Ø body = 200,00 mm)</p> <p>REF 144TA2324 (suspension track frame)</p>		<p>REF 143TA9037 (number of teeth = 17) (number of holes = 8) (dual speed)</p> <p>REF 144TA2344 (number of teeth = 17) (number of holes = 6) (single speed)</p>	<p>REF 144TA2322 (front, with bracket assembly) (Ø = 350,00 mm)</p> <p>REF 144TA2323 (rear, with bracket assembly) (solid mount track frame) (Ø = 290,00 mm)</p>	<p>REF 164TA1405 (rubber) (320 x 86 x 52)</p> <p>REF 164TA1406 (rubber) (450 x 86 x 52)</p>
<i>S/P: A3P0 - S/N: 20001 - and up</i>				
<p>REF 164TA1423 (solid mount track frame)</p> <p>REF 164TA1428 (suspension track frame)</p>		<p>REF 143TA9037 (number of teeth = 17) (number of holes = 8) (dual speed)</p> <p>REF 144TA2344 (number of teeth = 17) (number of holes = 6) (single speed)</p>	<p>REF 164TA1427 (front, with bracket assembly)</p> <p>REF 164TA1426 (rear, with bracket assembly)</p>	<p>REF 164TA1405 (rubber) (320 x 86 x 52)</p> <p>REF 164TA1406 (rubber) (450 x 86 x 52)</p>
<i>S/P: A3P1 - S/N: 11001 - 13999</i>				
<p>REF 144TA2305 (solid mount track frame) (Ø flange = 214,00 mm) (Ø body = 200,00 mm)</p> <p>REF 144TA2324 (suspension track frame)</p>		<p>REF 143TA9037 (number of teeth = 17) (number of holes = 8) (dual speed)</p> <p>REF 144TA2344 (number of teeth = 17) (number of holes = 6) (single speed)</p>	<p>REF 144TA2322 (front, with bracket assembly) (Ø = 350,00 mm)</p> <p>REF 144TA2409 (rear, with bracket assembly) (roller suspension track frame)</p> <p>REF 144TA2323 (rear, with bracket assembly) (solid mount track frame) (Ø = 290,00 mm)</p>	<p>REF 164TA1405 (rubber) (320 x 86 x 52)</p> <p>REF 164TA1406 (rubber) (450 x 86 x 52)</p>
<i>S/P: A3P1 - S/N: 14001 - and up</i>				
<p>REF 164TA1423 (solid mount track frame)</p> <p>REF 164TA1428 (suspension track frame)</p>		<p>REF 143TA9037 (number of teeth = 17) (number of holes = 8) (dual speed)</p> <p>REF 144TA2344 (number of teeth = 17) (number of holes = 6) (single speed)</p>	<p>REF 164TA1427 (front, with bracket assembly)</p> <p>REF 164TA1426 (rear, with bracket assembly)</p>	<p>REF 164TA1405 (rubber) (320 x 86 x 52)</p> <p>REF 164TA1406 (rubber) (450 x 86 x 52)</p>
<i>S/P: ALJG - S/N: 11001 - 15999</i>				
<p>REF 144TA2305 (solid mount track frame) (Ø flange = 214,00 mm) (Ø body = 200,00 mm)</p> <p>REF 144TA2324 (suspension track frame)</p>		<p>REF 143TA9037 (number of teeth = 17) (number of holes = 8) (dual speed)</p> <p>REF 144TA2344 (number of teeth = 17) (number of holes = 6) (single speed)</p>	<p>REF 144TA2322 (front, with bracket assembly) (Ø = 350,00 mm)</p> <p>REF 144TA2323 (rear, with bracket assembly) (solid mount track frame) (Ø = 290,00 mm)</p> <p>REF 144TA2409 (rear, with bracket assembly) (roller suspension track frame)</p>	<p>REF 164TA1405 (rubber) (320 x 86 x 52)</p> <p>REF 164TA1406 (rubber) (450 x 86 x 52)</p>



used for BOBCAT				
TRACK ROLLER	TOP ROLLER	SPROCKET	IDLER	TRACK
				
<i>S/P: ALJG - S/N: 16001 - and up</i>				
<p>REF 164TA1423 (solid mount track frame)</p> <p>REF 164TA1428 (suspension track frame)</p>		<p>REF 143TA9037 (number of teeth = 17) (number of holes = 8) (dual speed)</p> <p>REF 144TA2344 (number of teeth = 17) (number of holes = 6) (single speed)</p>	<p>REF 164TA1427 (front, with bracket assembly)</p> <p>REF 164TA1426 (rear, with bracket assembly)</p>	<p>REF 164TA1405 (rubber) (320 x 86 x 52)</p> <p>REF 164TA1406 (rubber) (450 x 86 x 52)</p>
<i>S/P: B2KZ - S/N: 11001 - 11999</i>				
<p>REF 144TA2305 (solid mount track frame) (Ø flange = 214,00 mm) (Ø body = 200,00 mm)</p> <p>REF 144TA2324 (suspension track frame)</p>		<p>REF 143TA9037 (number of teeth = 17) (number of holes = 8) (dual speed)</p> <p>REF 144TA2344 (number of teeth = 17) (number of holes = 6) (single speed)</p>	<p>REF 144TA2322 (front, with bracket assembly) (Ø = 350,00 mm)</p> <p>REF 144TA2323 (rear, with bracket assembly) (solid mount track frame) (Ø = 290,00 mm)</p> <p>REF 144TA2409 (rear, with bracket assembly) (roller suspension track frame)</p>	<p>REF 164TA1405 (rubber) (320 x 86 x 52)</p> <p>REF 164TA1406 (rubber) (450 x 86 x 52)</p>
<i>S/P: B2KZ - S/N: 12001 - and up</i>				
<p>REF 164TA1423 (solid mount track frame)</p> <p>REF 164TA1428 (suspension track frame)</p>		<p>REF 143TA9037 (number of teeth = 17) (number of holes = 8) (dual speed)</p> <p>REF 144TA2344 (number of teeth = 17) (number of holes = 6) (single speed)</p>	<p>REF 164TA1427 (front, with bracket assembly)</p> <p>REF 164TA1426 (rear, with bracket assembly)</p>	<p>REF 164TA1405 (rubber) (320 x 86 x 52)</p> <p>REF 164TA1406 (rubber) (450 x 86 x 52)</p>
<i>S/P: T1ML - S/N: 11001 - and up</i>				
<p>REF 144TA2305 (solid mount track frame) (Ø flange = 214,00 mm) (Ø body = 200,00 mm)</p> <p>REF 144TA2324 (suspension track frame)</p>		<p>REF 143TA9037 (number of teeth = 17) (number of holes = 8) (dual speed)</p> <p>REF 144TA2344 (number of teeth = 17) (number of holes = 6) (single speed)</p>	<p>REF 144TA2322 (front, with bracket assembly) (Ø = 350,00 mm)</p> <p>REF 144TA2323 (rear, with bracket assembly) (solid mount track frame) (Ø = 290,00 mm)</p> <p>REF 144TA2409 (rear, with bracket assembly) (roller suspension track frame)</p>	<p>REF 164TA1405 (rubber) (320 x 86 x 52)</p> <p>REF 164TA1406 (rubber) (450 x 86 x 52)</p>
BOBCAT T740				
<i>S/P: B3CA - S/N: 11001 - and up</i>				
<p>REF 164TA1423 (solid mount track frame)</p> <p>REF 164TA1428 (suspension track frame)</p>		<p>REF 143TA9037 (number of teeth = 17) (number of holes = 8) (dual speed)</p> <p>REF 144TA2344 (number of teeth = 17) (number of holes = 6) (single speed)</p>	<p>REF 164TA1427 (front, with bracket assembly)</p> <p>REF 164TA1426 (rear, with bracket assembly)</p>	<p>REF 144TA2178 (rubber) (320 x 86 x 55)</p> <p>REF 143TA9647 (rubber) (450 x 86 x 55)</p>

TRACKS & UNDERCARRIAGE PARTS



used for BOBCAT

used for BOBCAT				
TRACK ROLLER	TOP ROLLER	SPROCKET	IDLER	TRACK
				
BOBCAT T750				
<i>S/P: ANKA - S/N: 11001 - 14999</i>				
<p>REF 144TA2305 (for rubber tracks) (solid mount track frame) (Ø flange = 214,00 mm) (Ø body = 200,00 mm)</p> <p>REF 144TA2324 (for rubber tracks) (suspension track frame)</p> <p>REF 164TA1417 (steel tracks) (solid mount)</p>		<p>REF 143TA9037 (for rubber tracks) (number of teeth = 17) (number of holes = 8) (dual speed)</p> <p>REF 144TA2344 (for rubber tracks) (number of teeth = 17) (number of holes = 6) (single speed)</p> <p>REF 144TA2443 (for steel tracks) (solid mount)</p>	<p>REF 144TA2322 (front, with bracket assembly) (for rubber tracks) (Ø = 350,00 mm)</p> <p>REF 144TA2323 (rear, with bracket assembly) (for rubber tracks) (solid mount track frame) (Ø = 290,00 mm)</p> <p>REF 144TA2409 (rear, with bracket assembly) (for rubber tracks) (suspension track frame)</p> <p>REF 164TA1415 (front and rear, with bracket assembly) (for steel tracks) (solid mount)</p>	<p>REF 144TA2178 (rubber) (320 x 86 x 55)</p> <p>REF 143TA9647 (rubber) (450 x 86 x 55)</p>
<i>S/P: ANKA - S/N: 15001 - and up</i>				
<p>REF 164TA1423 (for rubber tracks) (solid mount track frame)</p> <p>REF 164TA1428 (for rubber tracks) (suspension track frame)</p> <p>REF 164TA1417 (steel tracks) (solid mount)</p>		<p>REF 143TA9037 (for rubber tracks) (number of teeth = 17) (number of holes = 8) (dual speed)</p> <p>REF 144TA2344 (for rubber tracks) (number of teeth = 17) (number of holes = 6) (single speed)</p> <p>REF 144TA2443 (for steel tracks) (solid mount)</p>	<p>REF 164TA1427 (front, with bracket assembly) (for rubber tracks)</p> <p>REF 164TA1426 (rear, with bracket assembly) (for rubber tracks)</p> <p>REF 164TA1415 (front and rear, with bracket assembly) (for steel tracks) (solid mount)</p>	<p>REF 144TA2178 (rubber) (320 x 86 x 55)</p> <p>REF 143TA9647 (rubber) (450 x 86 x 55)</p>
<i>S/P: AT5T</i>				
<p>REF 144TA2305 (solid mount track frame) (Ø flange = 214,00 mm) (Ø body = 200,00 mm)</p> <p>REF 144TA2324 (suspension track frame)</p> <p>REF 164TA1423 (solid mount track frame)</p> <p>REF 164TA1428 (suspension track frame)</p>		<p>REF 143TA9037 (number of teeth = 17) (number of holes = 8) (dual speed)</p> <p>REF 144TA2344 (number of teeth = 17) (number of holes = 6) (single speed)</p>	<p>REF 144TA2322 (front, with bracket assembly) (Ø = 350,00 mm)</p> <p>REF 164TA1427 (front, with bracket assembly)</p> <p>REF 144TA2409 (rear, with bracket assembly) (suspension track frame)</p> <p>REF 164TA1426 (rear, with bracket assembly)</p> <p>REF 144TA2323 (rear, with bracket assembly) (solid mount track frame) (Ø = 290,00 mm)</p>	<p>REF 144TA2178 (rubber) (320 x 86 x 55)</p> <p>REF 143TA9647 (rubber) (450 x 86 x 55)</p>
<i>S/P: ATF6 - S/N: 11001 - and up</i>				
<p>REF 144TA2305 (for rubber tracks) (solid mount track frame) (Ø flange = 214,00 mm) (Ø body = 200,00 mm)</p>		<p>REF 143TA9037 (for rubber tracks) (number of teeth = 17) (number of holes = 8) (dual speed)</p>	<p>REF 144TA2322 (front, with bracket assembly) (for rubber tracks) (Ø = 350,00 mm)</p>	<p>REF 144TA2178 (rubber) (320 x 86 x 55)</p>







used for BOBCAT				
TRACK ROLLER	TOP ROLLER	SPROCKET	IDLER	TRACK
				
<p>REF 144TA2324 (for rubber tracks) (suspension track frame)</p> <p>REF 164TA1417 (steel tracks) (solid mount)</p>		<p>REF 144TA2344 (for rubber tracks) (number of teeth = 17) (number of holes = 6) (single speed)</p> <p>REF 144TA2443 (for steel tracks) (solid mount)</p>	<p>REF 164TA1415 (front and rear, with bracket assembly) (for steel tracks) (solid mount)</p> <p>REF 144TA2323 (rear, with bracket assembly) (for rubber tracks) (solid mount track frame) (Ø = 290,00 mm)</p> <p>REF 144TA2409 (rear, with bracket assembly) (for rubber tracks) (suspension track frame)</p>	<p>REF 143TA9647 (rubber) (450 x 86 x 55)</p>
BOBCAT T770				
<i>S/P: A3P8 - S/N: 11001 - 15999</i>				
<p>REF 144TA2305 (for rubber tracks) (solid mount track frame) (Ø flange = 214,00 mm) (Ø body = 200,00 mm)</p> <p>REF 144TA2324 (for rubber tracks) (suspension track frame)</p> <p>REF 164TA1417 (steel tracks) (solid mount)</p>		<p>REF 143TA9037 (for rubber tracks) (number of teeth = 17) (number of holes = 8) (dual speed)</p> <p>REF 144TA2344 (for rubber tracks) (number of teeth = 17) (number of holes = 6) (single speed)</p> <p>REF 144TA2443 (for steel tracks) (solid mount)</p>	<p>REF 144TA2322 (front, with bracket assembly) (for rubber tracks) (Ø = 350,00 mm)</p> <p>REF 144TA2323 (rear, with bracket assembly) (for rubber tracks) (solid mount track frame) (Ø = 290,00 mm)</p> <p>REF 144TA2409 (rear, with bracket assembly) (for rubber tracks) (suspension track frame)</p> <p>REF 164TA1415 (front and rear, with bracket assembly) (for steel tracks) (solid mount)</p>	<p>REF 144TA2178 (rubber) (320 x 86 x 55)</p> <p>REF 143TA9647 (rubber) (450 x 86 x 55)</p>
<i>S/P: A3P8 - S/N: 16001 - and up</i>				
<p>REF 164TA1423 (for rubber tracks) (solid mount track frame)</p> <p>REF 164TA1428 (for rubber tracks) (suspension track frame)</p> <p>REF 164TA1417 (steel tracks) (solid mount)</p>		<p>REF 143TA9037 (for rubber tracks) (number of teeth = 17) (number of holes = 8) (dual speed)</p> <p>REF 144TA2344 (for rubber tracks) (number of teeth = 17) (number of holes = 6) (single speed)</p> <p>REF 144TA2443 (for steel tracks) (solid mount)</p>	<p>REF 164TA1427 (front, with bracket assembly) (for rubber tracks)</p> <p>REF 164TA1426 (rear, with bracket assembly) (for rubber tracks)</p> <p>REF 164TA1415 (front and rear, with bracket assembly) (for steel tracks) (solid mount)</p>	<p>REF 144TA2178 (rubber) (320 x 86 x 55)</p> <p>REF 143TA9647 (rubber) (450 x 86 x 55)</p>
<i>S/P: A3P9 - S/N: 11001 - 12999</i>				
<p>REF 144TA2305 (for rubber tracks) (solid mount track frame) (Ø flange = 214,00 mm) (Ø body = 200,00 mm)</p> <p>REF 144TA2324 (for rubber tracks) (suspension track frame)</p>		<p>REF 143TA9037 (for rubber tracks) (number of teeth = 17) (number of holes = 8) (dual speed)</p> <p>REF 144TA2344 (for rubber tracks) (number of teeth = 17) (number of holes = 6) (single speed)</p>	<p>REF 144TA2322 (front, with bracket assembly) (for rubber tracks) (Ø = 350,00 mm)</p> <p>REF 144TA2323 (rear, with bracket assembly) (for rubber tracks) (solid mount track frame) (Ø = 290,00 mm)</p>	<p>REF 144TA2178 (rubber) (320 x 86 x 55)</p> <p>REF 143TA9647 (rubber) (450 x 86 x 55)</p>



used for BOBCAT				
TRACK ROLLER	TOP ROLLER	SPROCKET	IDLER	TRACK
				
REF 164TA1417 (steel tracks) (solid mount)		REF 144TA2443 (for steel tracks) (solid mount)	REF 144TA2409 (rear, with bracket assembly) (for rubber tracks) (suspension track frame) REF 164TA1415 (front and rear, with bracket assembly) (for steel tracks) (solid mount)	
<i>S/P: A3P9 - S/N: 13001 - and up</i>				
REF 164TA1423 (for rubber tracks) (solid mount track frame)		REF 143TA9037 (for rubber tracks) (number of teeth = 17) (number of holes = 8) (dual speed)	REF 164TA1427 (front, with bracket assembly) (for rubber tracks)	REF 144TA2178 (rubber) (320 x 86 x 55)
REF 164TA1428 (for rubber tracks) (suspension track frame)		REF 144TA2344 (for rubber tracks) (number of teeth = 17) (number of holes = 6) (single speed)	REF 164TA1426 (rear, with bracket assembly) (for rubber tracks)	REF 143TA9647 (rubber) (450 x 86 x 55)
REF 164TA1417 (steel tracks) (solid mount)		REF 144TA2443 (for steel tracks) (solid mount)	REF 164TA1415 (front and rear, with bracket assembly) (for steel tracks) (solid mount)	
<i>S/P: AN8T - S/N: 11001 - and up</i>				
REF 144TA2305 (for rubber tracks) (solid mount track frame) (Ø flange = 214,00 mm) (Ø body = 200,00 mm)		REF 143TA9037 (for rubber tracks) (number of teeth = 17) (number of holes = 8) (dual speed)	REF 144TA2322 (front, with bracket assembly) (for rubber tracks) (Ø = 350,00 mm)	REF 144TA2178 (rubber) (320 x 86 x 55)
REF 144TA2324 (for rubber tracks) (suspension track frame)		REF 144TA2344 (for rubber tracks) (number of teeth = 17) (number of holes = 6) (single speed)	REF 164TA1415 (front and rear, with bracket assembly) (for steel tracks) (solid mount)	REF 143TA9647 (rubber) (450 x 86 x 55)
REF 164TA1417 (steel tracks) (solid mount)		REF 144TA2443 (for steel tracks) (solid mount)	REF 144TA2409 (rear, with bracket assembly) (for rubber tracks) (suspension track frame) REF 144TA2323 (rear, with bracket assembly) (for rubber tracks) (solid mount track frame) (Ø = 290,00 mm)	
<i>S/P: AT63 - S/N: 11001 - and up</i>				
REF 164TA1423 (solid mount track frame)		REF 143TA9037 (number of teeth = 17) (number of holes = 8) (dual speed)	REF 164TA1427 (front, with bracket assembly)	REF 144TA2178 (rubber) (320 x 86 x 55)
REF 164TA1428 (suspension track frame)		REF 144TA2344 (number of teeth = 17) (number of holes = 6) (single speed)	REF 164TA1426 (rear, with bracket assembly)	REF 143TA9647 (rubber) (450 x 86 x 55)
<i>S/P: ATF7 - S/N: 11001 - and up</i>				
REF 144TA2305 (for rubber tracks) (solid mount track frame) (Ø flange = 214,00 mm) (Ø body = 200,00 mm)		REF 143TA9037 (for rubber tracks) (number of teeth = 17) (number of holes = 8) (dual speed)	REF 144TA2322 (front, with bracket assembly) (for rubber tracks) (Ø = 350,00 mm)	REF 144TA2178 (rubber) (320 x 86 x 55)







used for BOBCAT				
TRACK ROLLER	TOP ROLLER	SPROCKET	IDLER	TRACK
				
<p>REF 144TA2324 (for rubber tracks) (suspension track frame)</p> <p>REF 164TA1417 (steel tracks) (solid mount)</p>		<p>REF 144TA2344 (for rubber tracks) (number of teeth = 17) (number of holes = 6) (single speed)</p> <p>REF 144TA2443 (for steel tracks) (solid mount)</p>	<p>REF 164TA1415 (front and rear, with bracket assembly) (for steel tracks) (solid mount)</p> <p>REF 144TA2323 (rear, with bracket assembly) (for rubber tracks) (solid mount track frame) (Ø = 290,00 mm)</p> <p>REF 144TA2409 (rear, with bracket assembly) (for rubber tracks) (suspension track frame)</p>	<p>REF 143TA9647 (rubber) (450 x 86 x 55)</p>
<i>S/P: AU5B - S/N: 11001 - and up</i>				
<p>REF 144TA2305 (for rubber tracks) (solid mount track frame) (Ø flange = 214,00 mm) (Ø body = 200,00 mm)</p> <p>REF 144TA2324 (for rubber tracks) (suspension track frame)</p> <p>REF 164TA1417 (steel tracks) (solid mount)</p>		<p>REF 143TA9037 (for rubber tracks) (number of teeth = 17) (number of holes = 8) (dual speed)</p> <p>REF 144TA2344 (for rubber tracks) (number of teeth = 17) (number of holes = 6) (single speed)</p> <p>REF 144TA2443 (for steel tracks) (solid mount)</p>	<p>REF 144TA2322 (front, with bracket assembly) (for rubber tracks) (Ø = 350,00 mm)</p> <p>REF 164TA1415 (front and rear, with bracket assembly) (for steel tracks) (solid mount)</p> <p>REF 144TA2323 (rear, with bracket assembly) (for rubber tracks) (solid mount track frame) (Ø = 290,00 mm)</p> <p>REF 144TA2409 (rear, with bracket assembly) (for rubber tracks) (suspension track frame)</p>	<p>REF 144TA2178 (rubber) (320 x 86 x 55)</p> <p>REF 143TA9647 (rubber) (450 x 86 x 55)</p>
<i>S/P: B3BW - S/N: 11001 - 11999</i>				
<p>REF 144TA2305 (solid mount track frame) (Ø flange = 214,00 mm) (Ø body = 200,00 mm)</p> <p>REF 144TA2324 (suspension track frame)</p>		<p>REF 143TA9037 (number of teeth = 17) (number of holes = 8) (dual speed)</p> <p>REF 144TA2344 (number of teeth = 17) (number of holes = 6) (single speed)</p>	<p>REF 144TA2322 (front, with bracket assembly) (Ø = 350,00 mm)</p> <p>REF 144TA2323 (rear, with bracket assembly) (solid mount track frame) (Ø = 290,00 mm)</p> <p>REF 144TA2409 (rear, with bracket assembly) (suspension track frame)</p>	<p>REF 144TA2178 (rubber) (320 x 86 x 55)</p> <p>REF 143TA9647 (rubber) (450 x 86 x 55)</p>
<i>S/P: B3BW - S/N: 12001 - and up</i>				
<p>REF 164TA1423 (solid mount track frame)</p> <p>REF 164TA1428 (suspension track frame)</p>		<p>REF 143TA9037 (number of teeth = 17) (number of holes = 8) (dual speed)</p> <p>REF 144TA2344 (number of teeth = 17) (number of holes = 6) (single speed)</p>	<p>REF 164TA1427 (front, with bracket assembly)</p> <p>REF 164TA1426 (rear, with bracket assembly)</p>	<p>REF 144TA2178 (rubber) (320 x 86 x 55)</p> <p>REF 143TA9647 (rubber) (450 x 86 x 55)</p>

TRACKS & UNDERCARRIAGE PARTS



used for BOBCAT

used for BOBCAT				
TRACK ROLLER	TOP ROLLER	SPROCKET	IDLER	TRACK
				
BOBCAT T870				
<i>S/P: A3PG - S/N: 11001 - and up</i>				
REF 144TA2478		REF 144TA2344 (number of teeth = 17) (number of holes = 6) (single speed) REF 143TA9037 (number of teeth = 17) (number of holes = 8) (dual speed)	REF 144TA2479 (front, with bracket assembly) (Ø = 350,00 mm) REF 144TA2480 (rear, with bracket assembly) (Ø = 290,00 mm)	REF 164TA1408 (rubber) (450 x 86 x 58) (c-tread)
<i>S/P: A3PH - S/N: 11001 - and up</i>				
REF 144TA2478		REF 144TA2344 (number of teeth = 17) (number of holes = 6) (single speed) REF 143TA9037 (number of teeth = 17) (number of holes = 8) (dual speed)	REF 144TA2479 (front, with bracket assembly) (Ø = 350,00 mm) REF 144TA2480 (rear, with bracket assembly) (Ø = 290,00 mm)	REF 164TA1408 (rubber) (450 x 86 x 58) (c-tread)
<i>S/P: AN8L - S/N: 11001 - and up</i>				
REF 144TA2478		REF 144TA2344 (number of teeth = 17) (number of holes = 6) (single speed) REF 143TA9037 (number of teeth = 17) (number of holes = 8) (dual speed)	REF 144TA2479 (front, with bracket assembly) (Ø = 350,00 mm) REF 144TA2480 (rear, with bracket assembly) (Ø = 290,00 mm)	REF 164TA1408 (rubber) (450 x 86 x 58) (c-tread)
<i>S/P: ASWT - S/N: 11001 - and up</i>				
REF 144TA2478		REF 144TA2344 (number of teeth = 17) (number of holes = 6) (single speed) REF 143TA9037 (number of teeth = 17) (number of holes = 8) (dual speed)	REF 144TA2479 (front, with bracket assembly) (Ø = 350,00 mm) REF 144TA2480 (rear, with bracket assembly) (Ø = 290,00 mm)	REF 164TA1408 (rubber) (450 x 86 x 58) (c-tread)
<i>S/P: ATF8 - S/N: 11001 - and up</i>				
REF 144TA2478		REF 144TA2344 (number of teeth = 17) (number of holes = 6) (single speed) REF 143TA9037 (number of teeth = 17) (number of holes = 8) (dual speed)	REF 144TA2479 (front, with bracket assembly) (Ø = 350,00 mm) REF 144TA2480 (rear, with bracket assembly) (Ø = 290,00 mm)	REF 164TA1408 (rubber) (450 x 86 x 58) (c-tread)
<i>S/P: B3BZ - S/N: 11001 - and up</i>				
REF 144TA2478		REF 144TA2344 (number of teeth = 17) (number of holes = 6) (single speed) REF 143TA9037 (number of teeth = 17) (number of holes = 8) (dual speed)	REF 144TA2479 (front, with bracket assembly) (Ø = 350,00 mm) REF 144TA2480 (rear, with bracket assembly) (Ø = 290,00 mm)	REF 164TA1408 (rubber) (450 x 86 x 58) (c-tread)



used for **BOBCAT**

TRACK ROLLER	TOP ROLLER	SPROCKET	IDLER	TRACK
				

BOBCAT ZX125

S/P: A97 - S/N: 11001 - and up

<p>REF 144TA2217 (for rubber and steel tracks) (outer guide roller) (Ø flange = 166,00 mm) (Ø body = 137,00 mm)</p> <p>REF 144TA2304 (for rubber and steel tracks) (inner guide roller) (Ø flange = 185,00 mm) (Ø body = 130,00 mm)</p>	<p>REF 144TA2217 (assembly) (for rubber and all steel tracks) (Ø flange = 166,00 mm) (Ø body = 137,00 mm)</p>	<p>REF 144TA2218 (for rubber and all steel tracks)</p>	<p>REF 144TA2216 (front, with bracket assembly) (for rubber tracks) (Ø = 510,00 mm)</p> <p>REF 144TA2215 (front, with bracket assembly) (for steel tracks)</p>	<p>REF 143TA9942 (rubber) (500 x 92 x 78)</p>
---	--	---	--	--

BOBCAT ZX75

S/P: A96 - S/N: 11001 - and up

<p>REF 144TA2275 (for rubber tracks) (outer guide roller) (Ø flange = 155,00 mm) (Ø body = 121,00 mm)</p> <p>REF 144TA2276 (for rubber tracks) (inner guide roller) (Ø flange = 188,00 mm) (Ø body = 135,00 mm)</p> <p>REF 144TA2275 (for steel tracks) (Ø flange = 155,00 mm) (Ø body = 121,00 mm)</p>	<p>REF 144TA2274 (assembly) (for rubber and steel tracks) (Ø flange = 115,00 mm) (Ø body = 95,00 mm)</p>	<p>REF 144TA2277 (for rubber tracks) (number of teeth = 23) (number of holes = 16)</p> <p>REF 144TA2214 (for steel tracks)</p>	<p>REF 144TA2416 (front, with bracket assembly) (for rubber tracks) (idler with spring)</p> <p>REF 144TA2317 (front, with bracket assembly) (for steel tracks) (idler with spring)</p>	
--	---	--	--	--



USED FOR
CASE



used for CASE

used for CASE				
TRACK ROLLER	TOP ROLLER	SPROCKET	IDLER	TRACK
				
CASE 16				
<p>REF 164TA2090 (for rubber tracks)</p> <p>REF 163TA9059 (berco version) (∅ flange = 100,00 mm) (∅ body = 80,00 mm)</p> <p>REF 164TA2126 (for rubber tracks) (∅ flange = 112,00 mm) (∅ body = 88,00 mm)</p>		<p>REF 144TA3879 (for rubber tracks) (number of teeth = 19) (number of holes = 9)</p> <p>REF 163TA9052 (for rubber tracks) (number of teeth = 19) (number of holes = 9)</p>	<p>REF 143TA9317 (front, with bracket assembly)</p>	<p>REF 164TA3049 (rubber) (230 x 96 x 31)</p>
CASE 28				
S/N: 0006219 - 0006999				
			<p>REF 144TA3881 (front, with bracket assembly) (for rubber tracks) (∅ = 346,00 mm)</p>	<p>REF 164TA3053 (rubber) (300 x 109 x 38)</p>
CASE 28DBK				
<p>REF 144TA3882 (double guide) (∅ flange = 118,00 mm) (∅ body = 94,00 mm)</p> <p>REF 144TA3886 (inner guide) (∅ flange = 119,00 mm) (∅ body = 95,00 mm)</p>	<p>REF 164TA3088 (assembly) (∅ body = 75,00 mm)</p>	<p>REF 163TA9053</p>	<p>REF 144TA3885 (front, with bracket assembly)</p> <p>REF 144TA3889 (front, with bracket assembly) (∅ = 338,00 mm)</p>	<p>REF 164TA3053 (rubber) (300 x 109 x 38)</p>
CASE 31DBK				
<p>REF 164TA2091 (inner guide) (∅ flange = 119,00 mm) (∅ body = 95,00 mm)</p> <p>REF 144TA3890 (double guide) (∅ flange = 118,00 mm) (∅ body = 94,00 mm)</p>	<p>REF 144TA3891 (assembly) (∅ body = 75,00 mm)</p>	<p>REF 163TA9053</p>	<p>REF 144TA3893 (front, with bracket assembly)</p>	<p>REF 163TA9041 (rubber) (300 x 109 x 40)</p>
CASE 35DBK				
<p>REF 144TA3898 (double guide) (∅ flange = 118,00 mm) (∅ body = 94,00 mm)</p> <p>REF 164TA2091 (inner guide) (∅ flange = 119,00 mm) (∅ body = 95,00 mm)</p>	<p>REF 144TA3903 (assembly) (∅ body = 75,00 mm)</p>	<p>REF 144TA3904 (number of teeth = 23) (number of holes = 9)</p>	<p>REF 144TA3901 (front, with bracket assembly)</p>	<p>REF 163TA9042 (rubber) (300 x 109 x 42)</p>
CASE 420CT				
<p>REF 144TA3870 (for rubber tracks) (∅ flange = 214,00 mm) (∅ body = 200,00 mm)</p>		<p>REF 144TA3871 (for rubber tracks) (number of teeth = 17) (number of holes = 8)</p>	<p>REF 144TA3873 (front, with bracket assembly) (∅ = 350,00 mm)</p> <p>REF 163TA9083 (rear, with bracket assembly) (∅ = 290,00 mm)</p>	<p>REF 143TA9658 (rubber) (320 x 86 x 50)</p>
CASE 440CT				
<p>REF 144TA3906 (∅ flange = 214,00 mm) (∅ body = 200,00 mm)</p>		<p>REF 144TA3907 (number of teeth = 17) (number of holes = 8)</p>	<p>REF 144TA3909 (front, with bracket assembly) (∅ = 350,00 mm)</p> <p>REF 163TA9083 (rear, with bracket assembly) (∅ = 290,00 mm)</p>	<p>REF 163TA9043 (rubber) (400 x 86 x 50)</p>



used for CASE				
TRACK ROLLER	TOP ROLLER	SPROCKET	IDLER	TRACK
				
CASE 445CT				
REF 144TA3910 (Ø flange = 214,00 mm) (Ø body = 200,00 mm)		REF 144TA3911 (number of teeth = 17) (number of holes = 8)	REF 144TA3913 (front, with bracket assembly) (Ø = 350,00 mm) REF 144TA3912 (rear, with bracket assembly) (Ø = 290,00 mm)	REF 163TA9044 (rubber) (400 x 86 x 55)
CASE 450CT				
<i>S/N: 0006001 - 0006218</i>				
REF 144TA3874 (for rubber tracks) (Ø flange = 214,00 mm) (Ø body = 200,00 mm)		REF 144TA3875 (for rubber tracks) (number of teeth = 17) (number of holes = 8)	REF 144TA3877 (front, with bracket assembly) (for rubber tracks) (Ø = 350,00 mm)	REF 143TA9649 (rubber) (450 x 84 x 56)
<i>For all other serial ranges applicable</i>				
REF 144TA3874 (for rubber tracks) (Ø flange = 214,00 mm) (Ø body = 200,00 mm)		REF 144TA3875 (for rubber tracks) (number of teeth = 17) (number of holes = 8)		REF 143TA9649 (rubber) (450 x 84 x 56)
CASE 9007				
REF 163TA9060 (inner guide) (Ø flange = 144,00 mm) (Ø body = 118,00 mm) REF 163TA9061 (outer guide)	REF 144TA3915 (assembly) (Ø flange = 110,00 mm) (Ø body = 90,00 mm)	REF 144TA3916 (number of teeth = 23) (number of holes = 12)	REF 143TA9310 (front, with bracket assembly) (for rubber tracks) REF 163TA9075 (front, with bracket assembly) (for steel tracks) (Ø = 428,00 mm)	REF 163TA9045 (rubber) (450 x 73,5 x 80)
CASE 9007B				
<i>S/N: 0050852 - and up</i>				
REF 144TA3924 (for rubber tracks) REF 144TA3923 (for rubber tracks) (Ø flange = 144,00 mm) (Ø body = 118,00 mm) REF 144TA3919 (for rubber tracks)	REF 144TA3920 (assembly) (for rubber tracks) (Ø flange = 110,00 mm) (Ø body = 90,00 mm) REF 144TA3925 (assembly) (for steel tracks) (Ø flange = 110,00 mm) (Ø body = 90,00 mm)	REF 144TA3921 (number of teeth = 23) (number of holes = 12) REF 144TA3926 (number of teeth = 23) (number of holes = 12)	REF 144TA3927 (front, with bracket assembly) (for rubber tracks) (Ø = 428,00 mm) REF 144TA3922 (front, with bracket assembly) (for rubber tracks)	REF 143TA9675 (rubber) (450 x 73,5 x 80)
<i>For all other serial ranges applicable</i>				
REF 144TA3924 (for rubber tracks) REF 144TA3923 (for rubber tracks) (Ø flange = 144,00 mm) (Ø body = 118,00 mm) REF 144TA3919 (for rubber tracks)	REF 144TA3920 (assembly) (for rubber tracks) (Ø flange = 110,00 mm) (Ø body = 90,00 mm) REF 144TA3925 (assembly) (for steel tracks) (Ø flange = 110,00 mm) (Ø body = 90,00 mm)	REF 144TA3921 (number of teeth = 23) (number of holes = 12) REF 144TA3926 (number of teeth = 23) (number of holes = 12)	REF 144TA3922 (front, with bracket assembly) (for rubber tracks)	REF 143TA9675 (rubber) (450 x 73,5 x 80)
CASE CK13				
<i>S/N: 1350001 - and up</i>				
REF 144TA3928 (Ø flange = 98,00 mm) (Ø body = 80,00 mm)		REF 144TA3929 (number of teeth = 19) (number of holes = 8)	REF 144TA3930 (front, with bracket assembly) (Ø = 240,00 mm)	REF 164TA3055 (rubber) (230 x 96 x 30)



used for CASE

used for CASE				
TRACK ROLLER	TOP ROLLER	SPROCKET	IDLER	TRACK
				
CASE CK15				
<i>S/N: 1550001 - and up</i>				
REF 144TA3931 (∅ flange = 98,00 mm) (∅ body = 80,00 mm)		REF 144TA3932 (number of teeth = 19) (number of holes = 8)	REF 144TA3933 (front, with bracket assembly) (∅ = 240,00 mm)	REF 164TA3055 (rubber) (230 x 96 x 30)
CASE CK25				
<i>S/N: 2550001 - and up</i>				
		REF 144TA1883 (number of teeth = 23) (number of holes = 9)		REF 139TA9636 (rubber) (300 x 109 x 35)
<i>S/N: GCK2555001 - and up</i>				
REF 144TA3934 (∅ flange = 123,70 mm) (∅ body = 95,00 mm)				REF 139TA9636 (rubber) (300 x 109 x 35)
<i>S/N: GCK2555001 - GCK2556356</i>				
REF 144TA3934 (∅ flange = 123,70 mm) (∅ body = 95,00 mm)			REF 163TA9076 (front, with bracket assembly)	REF 139TA9636 (rubber) (300 x 109 x 35)
<i>S/N: JCK2550001 - and up</i>				
			REF 163TA9076 (front, with bracket assembly)	REF 139TA9636 (rubber) (300 x 109 x 35)
<i>S/N: JCK2555001 - and up</i>				
REF 144TA3934 (∅ flange = 123,70 mm) (∅ body = 95,00 mm)			REF 163TA9076 (front, with bracket assembly)	
CASE CK28				
REF 144TA3936 (∅ flange = 123,70 mm) (∅ body = 95,00 mm)	REF 144TA1888 (assembly) (∅ body = 82,50 mm)	REF 144TA3937 (number of teeth = 23) (number of holes = 9)	REF 163TA9076 (front, with bracket assembly)	REF 139TA9636 (rubber) (300 x 109 x 35)
CASE CK31				
REF 144TA3939 (for rubber tracks) (∅ flange = 119,00 mm) (∅ body = 95,00 mm)	REF 144TA3940 (assembly) (for steel tracks) (∅ flange = 104,00 mm) (∅ body = 80,00 mm)	REF 144TA3941 (number of teeth = 23) (number of holes = 9)		REF 143TA9677 (rubber) (300 x 109 x 40)
CASE CK32				
REF 163TA9062 (∅ flange = 136,00 mm) (∅ body = 96,00 mm)	REF 163TA9069 (assembly) (∅ flange = 82,50 mm) (∅ body = 30,00 mm)	REF 163TA9054	REF 163TA9076 (front, with bracket assembly)	REF 163TA9046 (rubber) (300 x 109 x 39)
CASE CK35				
REF 144TA3946 (for rubber tracks) (∅ flange = 119,00 mm) (∅ body = 95,00 mm)	REF 144TA3947 (assembly) (for rubber tracks) (∅ flange = 104,00 mm) (∅ body = 80,00 mm)	REF 144TA3948 (for rubber tracks) (number of teeth = 23) (number of holes = 9)		REF 163TA9042 (rubber) (300 x 109 x 42)
CASE CK36				
REF 163TA9063	REF 144TA3950 (assembly) (∅ body = 82,50 mm)	REF 144TA3951 (number of teeth = 23) (number of holes = 9)	REF 163TA9077 (front, with bracket assembly)	REF 164TA3020 (rubber) (300 x 109 x 41)
CASE CK38				
<i>S/N: 0005001 - 0005391</i>				
REF 163TA9064 (∅ flange = 135,00 mm) (∅ body = 98,00 mm)	REF 163TA9069 (assembly) (∅ flange = 82,50 mm) (∅ body = 30,00 mm)	REF 163TA9055 (number of teeth = 23) (number of holes = 9)	REF 163TA9077 (front, with bracket assembly)	REF 163TA9047 (rubber) (350 x 56 x 84)







used for CASE				
TRACK ROLLER	TOP ROLLER	SPROCKET	IDLER	TRACK
				
<i>For all other serial ranges applicable</i>				
REF 163TA9064 (Ø flange = 135,00 mm) (Ø body = 98,00 mm)	REF 163TA9069 (assembly) (Ø flange = 82,50 mm) (Ø body = 30,00 mm)	REF 163TA9055 (number of teeth = 23) (number of holes = 9)	REF 163TA9077 (front, with bracket assembly)	
CASE CK50				
REF 163TA9065	REF 163TA9070 (assembly) (Ø flange = 130,00 mm) (Ø body = 104,00 mm)	REF 163TA9056 (number of teeth = 21) (number of holes = 9)	REF 163TA9078 (front, with bracket assembly) (for steel tracks) REF 163TA9079 (front, with bracket assembly) (for rubber tracks)	REF 163TA9048 (rubber) (400 x 72,5 x 72)
CASE CK52				
REF 163TA9066 (for rubber tracks) REF 163TA9067 (for steel tracks)	REF 163TA9071 (assembly) (Ø body = 98,00 mm)	REF 163TA9057 (number of teeth = 21) (number of holes = 9)	REF 163TA9080 (front, with bracket assembly)	REF 163TA9049 (rubber) (400 x 72,5 x 72)
CASE CK52-2				
<i>S/N: 0005001 - 0005999</i>				
REF 144TA3968 (for rubber tracks) (Ø flange = 130,00 mm) (Ø body = 97,00 mm) REF 144TA3964 (for steel tracks) (Ø flange = 145,00 mm) (Ø body = 105,00 mm)		REF 144TA3973 (for rubber tracks) (number of teeth = 21) (number of holes = 9) REF 144TA3966 (for rubber tracks) (number of teeth = 21) (number of holes = 9) REF 144TA3970 (for rubber tracks) (number of teeth = 21) (number of holes = 9)	REF 144TA3967 (front, with bracket assembly) (Ø = 390,00 mm) REF 144TA3974 (front, with bracket assembly) REF 144TA3971 (front, with bracket assembly) (Ø = 390,00 mm)	REF 163TA9049 (rubber) (400 x 72,5 x 72)
<i>S/N: 0006001 - 0006218</i>				
REF 144TA3964 (for steel tracks) (Ø flange = 145,00 mm) (Ø body = 105,00 mm)	REF 144TA3965 (assembly) (for rubber tracks) (Ø body = 98,00 mm)	REF 144TA3973 (for rubber tracks) (number of teeth = 21) (number of holes = 9) REF 144TA3966 (for rubber tracks) (number of teeth = 21) (number of holes = 9) REF 144TA3970 (for rubber tracks) (number of teeth = 21) (number of holes = 9)	REF 144TA3967 (front, with bracket assembly) (Ø = 390,00 mm) REF 144TA3974 (front, with bracket assembly) REF 144TA3971 (front, with bracket assembly) (Ø = 390,00 mm)	REF 163TA9049 (rubber) (400 x 72,5 x 72)
<i>S/N: 0006219 - 0006999</i>				
REF 144TA3964 (for steel tracks) (Ø flange = 145,00 mm) (Ø body = 105,00 mm)	REF 144TA3972 (assembly) (for rubber tracks) (Ø body = 98,00 mm)	REF 144TA3973 (for rubber tracks) (number of teeth = 21) (number of holes = 9) REF 144TA3966 (for rubber tracks) (number of teeth = 21) (number of holes = 9)	REF 144TA3967 (front, with bracket assembly) (Ø = 390,00 mm) REF 144TA3974 (front, with bracket assembly)	REF 163TA9049 (rubber) (400 x 72,5 x 72)





TRACKS & UNDERCARRIAGE PARTS



used for CASE

used for CASE				
TRACK ROLLER	TOP ROLLER	SPROCKET	IDLER	TRACK
				
		REF 144TA3970 (for rubber tracks) (number of teeth = 21) (number of holes = 9)	REF 144TA3971 (front, with bracket assembly) (Ø = 390,00 mm)	
<i>S/N: 0007001 - 0007289</i>				
REF 144TA3964 (for steel tracks) (Ø flange = 145,00 mm) (Ø body = 105,00 mm)	REF 144TA3969 (assembly) (for rubber tracks) (Ø body = 98,00 mm)	REF 144TA3973 (for rubber tracks) (number of teeth = 21) (number of holes = 9) REF 144TA3966 (for rubber tracks) (number of teeth = 21) (number of holes = 9) REF 144TA3970 (for rubber tracks) (number of teeth = 21) (number of holes = 9)	REF 144TA3967 (front, with bracket assembly) (Ø = 390,00 mm) REF 144TA3974 (front, with bracket assembly) REF 144TA3971 (front, with bracket assembly) (Ø = 390,00 mm)	REF 163TA9049 (rubber) (400 x 72,5 x 72)
<i>For all other serial ranges applicable</i>				
REF 144TA3964 (for steel tracks) (Ø flange = 145,00 mm) (Ø body = 105,00 mm)		REF 144TA3973 (for rubber tracks) (number of teeth = 21) (number of holes = 9) REF 144TA3966 (for rubber tracks) (number of teeth = 21) (number of holes = 9) REF 144TA3970 (for rubber tracks) (number of teeth = 21) (number of holes = 9)	REF 144TA3967 (front, with bracket assembly) (Ø = 390,00 mm) REF 144TA3974 (front, with bracket assembly) REF 144TA3971 (front, with bracket assembly) (Ø = 390,00 mm)	REF 163TA9049 (rubber) (400 x 72,5 x 72)
CASE CK62				
REF 163TA9068 (Ø body = 110,00 mm)	REF 163TA9072 (assembly)	REF 163TA9058	REF 163TA9081 (front, with bracket assembly)	REF 163TA9049 (rubber) (400 x 72,5 x 72)
CASE CX14				
<i>S/N: 0005392 - 0005999</i>				
		REF 144TA3977 (for rubber tracks) (number of teeth = 19) (number of holes = 9)	REF 144TA3978 (front, with bracket assembly) (Ø = 270,00 mm)	REF 143TA9681 (rubber) (230 x 48 x 70) (with rail)
<i>S/N: 0006219 - 0006999</i>				
REF 144TA3976 (for rubber tracks)		REF 144TA3977 (for rubber tracks) (number of teeth = 19) (number of holes = 9)	REF 144TA3978 (front, with bracket assembly) (Ø = 270,00 mm)	
<i>For all other serial ranges applicable</i>				
		REF 144TA3977 (for rubber tracks) (number of teeth = 19) (number of holes = 9)	REF 144TA3978 (front, with bracket assembly) (Ø = 270,00 mm)	
CASE CX15				
<i>S/N: 0007001 - 0007289</i>				
REF 144TA3979 (for rubber tracks) (Ø flange = 100,00 mm) (Ø body = 80,00 mm)		REF 144TA3980 (for rubber tracks) (number of teeth = 19) (number of holes = 9)	REF 144TA3981 (front, with bracket assembly)	REF 164TA3049 (rubber) (230 x 96 x 31)



used for CASE				
TRACK ROLLER	TOP ROLLER	SPROCKET	IDLER	TRACK
				
<i>For all other serial ranges applicable</i>				
		REF 144TA3980 (for rubber tracks) (number of teeth = 19) (number of holes = 9)	REF 144TA3981 (front, with bracket assembly)	REF 164TA3049 (rubber) (230 x 96 x 31)
CASE CX16				
REF 144TA3982 (∅ flange = 100,00 mm) (∅ body = 80,00 mm)		REF 144TA3983 (number of teeth = 19) (number of holes = 9)	REF 144TA3984 (front, with bracket assembly)	REF 164TA3049 (rubber) (230 x 96 x 31)
CASE CX16B				
REF 144TA3985 (∅ flange = 114,00 mm) (∅ body = 74,00 mm)		REF 144TA3986 (number of teeth = 19) (number of holes = 9)	REF 144TA3987 (front, with bracket assembly) (∅ = 270,00 mm)	REF 143TA9659 (rubber) (230 x 48 x 70) (with rail)
CASE CX17B				
REF 144TA3976		REF 144TA3989 (number of teeth = 19) (number of holes = 9)	REF 144TA3990 (front, with bracket assembly) (∅ = 270,00 mm)	REF 143TA9659 (rubber) (230 x 48 x 70) (with rail)
CASE CX18B				
REF 144TA3991 (∅ flange = 114,00 mm) (∅ body = 74,00 mm)		REF 144TA3992 (number of teeth = 19) (number of holes = 9)	REF 144TA3993 (front, with bracket assembly) (∅ = 270,00 mm)	REF 143TA9659 (rubber) (230 x 48 x 70) (with rail)
CASE CX20B				
<i>S/N: N4TN31001 - and up</i>				
REF 144TA3994 (∅ flange = 108,00 mm) (∅ body = 85,00 mm)		REF 144TA3995 (for steel tracks) (number of teeth = 19) (number of holes = 12)	REF 163TA9560 (front, with bracket assembly) (LH) (∅ = 346,00 mm) REF 164TA3089 (front, with bracket assembly) (RH)	REF 164TA3047 (rubber) (250 x 52,5 x 76)
<i>S/N: N5GN01294 - and up</i>				
REF 144TA3994 (∅ flange = 108,00 mm) (∅ body = 85,00 mm)		REF 144TA3995 (for steel tracks) (number of teeth = 19) (number of holes = 12)	REF 143TA9299 (front, with bracket assembly) (LH and RH) (∅ = 271,00 mm)	REF 164TA3047 (rubber) (250 x 52,5 x 76)
<i>For all other serial ranges applicable</i>				
REF 144TA3994 (∅ flange = 108,00 mm) (∅ body = 85,00 mm)		REF 144TA3995 (for steel tracks) (number of teeth = 19) (number of holes = 12)		REF 164TA3047 (rubber) (250 x 52,5 x 76)
CASE CX22B				
<i>S/N: N4TN31001 - and up</i>				
REF 144TA3997 (∅ flange = 108,00 mm) (∅ body = 85,00 mm)		REF 144TA3998 (number of teeth = 19) (number of holes = 12)	REF 164TA3089 (front, with bracket assembly) (RH) REF 163TA9560 (front, with bracket assembly) (LH) (∅ = 346,00 mm)	REF 164TA3047 (rubber) (250 x 52,5 x 76)
<i>S/N: N5GN01294 - and up</i>				
REF 144TA3997 (∅ flange = 108,00 mm) (∅ body = 85,00 mm)		REF 144TA3998 (number of teeth = 19) (number of holes = 12)	REF 143TA9299 (front, with bracket assembly) (RH) (∅ = 271,00 mm)	REF 164TA3047 (rubber) (250 x 52,5 x 76)



used for CASE

used for CASE				
TRACK ROLLER	TOP ROLLER	SPROCKET	IDLER	TRACK
				
			REF 143TA9299 (front, with bracket assembly) (LH) (Ø = 271,00 mm)	
CASE CX23				
REF 144TA4000 (Ø flange = 118,00 mm) (Ø body = 94,00 mm)		REF 144TA4001	REF 144TA4002 (front, with bracket assembly) (Ø = 346,00 mm)	REF 164TA3065 (rubber) (260 x 109 x 35)
CASE CX25				
<i>S/N: 0006001 - 0006218</i>				
REF 144TA4003 (for rubber tracks) (Ø flange = 132,00 mm) (Ø body = 80,00 mm)		REF 144TA4004 (for rubber tracks) (number of teeth = 19) (number of holes = 12)	REF 144TA4005 (front, with bracket assembly)	REF 164TA3056 (rubber) (250 x 52,5 x 76)
<i>For all other serial ranges applicable</i>				
REF 144TA4003 (for rubber tracks) (Ø flange = 132,00 mm) (Ø body = 80,00 mm)		REF 144TA4004 (for rubber tracks) (number of teeth = 19) (number of holes = 12)	REF 144TA4005 (front, with bracket assembly)	
CASE CX27B				
REF 144TA4006 (Ø flange = 108,00 mm) (Ø body = 85,00 mm)	REF 144TA4007 (assembly) (Ø body = 75,00 mm)	REF 144TA4008 (number of teeth = 19) (number of holes = 12)	REF 144TA4009 (front, with bracket assembly) (Ø = 271,00 mm)	REF 143TA9662 (rubber) (250 x 52,5 x 80)
CASE CX28				
REF 164TA2091 (Ø flange = 119,00 mm) (Ø body = 95,00 mm)	REF 144TA4012 (assembly) (Ø flange = 104,00 mm) (Ø body = 80,00 mm)	REF 163TA9053	REF 163TA9082 (front, with bracket assembly)	REF 163TA9050 (rubber) (300 x 109 x 88)
CASE CX31				
REF 164TA2091 (Ø flange = 119,00 mm) (Ø body = 95,00 mm)	REF 163TA9073 (assembly) (Ø flange = 104,00 mm) (Ø body = 80,00 mm)	REF 163TA9053	REF 164TA2127 (front, with bracket assembly)	REF 163TA9041 (rubber) (300 x 109 x 40)
CASE CX31B				
REF 144TA4019 (Ø flange = 108,00 mm) (Ø body = 85,00 mm)	REF 144TA4020 (assembly) (Ø body = 75,00 mm)	REF 144TA4021 (for rubber tracks) (number of teeth = 23) (number of holes = 9)	REF 164TA2128 (front, with bracket assembly)	REF 164TA3023 (rubber) (300 x 52,5 x 82)
CASE CX35				
REF 164TA2091 (Ø flange = 119,00 mm) (Ø body = 95,00 mm)	REF 144TA4025 (assembly) (for rubber tracks) (Ø flange = 104,00 mm) (Ø body = 80,00 mm)	REF 144TA4026 (number of teeth = 23) (number of holes = 9)	REF 163TA9082 (front, with bracket assembly)	REF 163TA9042 (rubber) (300 x 109 x 42)
CASE CX36				
<i>S/N: 0005001 - 0005391</i>				
	REF 144TA4029 (assembly) (for rubber tracks) (Ø body = 75,00 mm)	REF 144TA4030 (for rubber tracks) (number of teeth = 23) (number of holes = 9)	REF 144TA4031 (front, with bracket assembly) (Ø = 345,00 mm)	
<i>S/N: 0007290 - 0007999</i>				
	REF 144TA4029 (assembly) (for rubber tracks) (Ø body = 75,00 mm)	REF 144TA4030 (for rubber tracks) (number of teeth = 23) (number of holes = 9)	REF 144TA4031 (front, with bracket assembly) (Ø = 345,00 mm)	REF 143TA9685 (rubber) (300 x 52,5 x 88)



used for CASE				
TRACK ROLLER	TOP ROLLER	SPROCKET	IDLER	TRACK
				
<i>S/N: 0050852 - and up</i>				
REF 144TA4028 (for rubber tracks) (Ø flange = 148,00 mm) (Ø body = 93,00 mm)	REF 144TA4029 (assembly) (for rubber tracks) (Ø body = 75,00 mm)	REF 144TA4030 (for rubber tracks) (number of teeth = 23) (number of holes = 9)	REF 144TA4031 (front, with bracket assembly) (Ø = 345,00 mm)	
CASE CX36B				
REF 144TA4032 (Ø flange = 108,00 mm) (Ø body = 85,00 mm)	REF 144TA4033 (assembly) (Ø body = 75,00 mm)	REF 144TA4034 (number of teeth = 23) (number of holes = 9)	REF 143TA9301 (front, with bracket assembly)	REF 163TA9293 (rubber) (300 x 52,5 x 88)
CASE CX40B				
REF 144TA4037 (Ø flange = 130,00 mm) (Ø body = 100,00 mm)	REF 144TA4038 (assembly) (Ø body = 88,00 mm)	REF 144TA4039 (number of teeth = 19) (number of holes = 12)	REF 144TA4040 (front, with bracket assembly) (Ø = 362,00 mm)	REF 143TA9665 (rubber) (400 x 74 x 68)
CASE CX47				
REF 144TA4041 (for rubber tracks)	REF 144TA4042 (assembly) (for rubber tracks)	REF 144TA4043 (for rubber tracks) (number of teeth = 19) (number of holes = 12)	REF 144TA4044 (front, with bracket assembly)	REF 143TA9686 (rubber)
CASE CX50				
REF 144TA4045 (Ø flange = 130,00 mm) (Ø body = 100,00 mm)	REF 144TA4046 (assembly) (Ø body = 88,00 mm)	REF 144TA4047	REF 144TA4048 (front, with bracket assembly)	REF 163TA9051 (rubber) (400 x 72,5 x 72)
CASE CX50B				
REF 144TA4049 (Ø flange = 130,00 mm) (Ø body = 100,00 mm)	REF 144TA4050 (assembly) (Ø body = 88,00 mm)	REF 144TA4051 (number of teeth = 19) (number of holes = 12)	REF 163TA9561 (front, with bracket assembly) (Ø = 362,00 mm)	REF 164TA2032 (rubber) (400 x 74 x 72)
CASE CX75SR				
REF 144TA4053 (for rubber tracks) (Ø flange = 144,00 mm) (Ø body = 118,00 mm)		REF 144TA4054 (for rubber tracks) (number of teeth = 21) (number of holes = 12)		REF 164TA3020 (rubber) (300 x 109 x 41) REF 143TA9687 (rubber) (450 x 81 x 76)
CASE CX80				
REF 144TA4055 (for rubber tracks) (Ø flange = 144,00 mm) (Ø body = 118,00 mm)		REF 144TA4056 (for rubber tracks) (number of teeth = 21) (number of holes = 12)		REF 164TA3020 (rubber) (300 x 109 x 41) REF 143TA9687 (rubber) (450 x 81 x 76)
CASE TR270				
REF 144TA4057 (Ø flange = 214,00 mm) (Ø body = 100,00 mm)		REF 144TA4058 (number of teeth = 17) (number of holes = 8)	REF 144TA4060 (front, with bracket assembly) (Ø = 350,00 mm) REF 163TA9083 (rear, with bracket assembly) (Ø = 290,00 mm)	REF 143TA9658 (rubber) (320 x 86 x 50)
CASE TR320				
REF 144TA4061 (Ø flange = 214,00 mm) (Ø body = 100,00 mm)		REF 144TA4062 (number of teeth = 17) (number of holes = 8)	REF 144TA4064 (front, with bracket assembly) (Ø = 350,00 mm) REF 144TA4063 (rear, with bracket assembly) (Ø = 290,00 mm)	REF 164TA3083 (rubber) (450 x 84 x 56)



used for CASE

used for CASE				
TRACK ROLLER	TOP ROLLER	SPROCKET	IDLER	TRACK
				
CASE TV380				
<p>REF 144TA4065 (for rubber tracks) (Ø flange = 214,00 mm) (Ø body = 100,00 mm)</p>		<p>REF 144TA4066 (number of teeth = 17) (number of holes = 8)</p>	<p>REF 144TA4068 (front, with bracket assembly) (Ø = 350,00 mm)</p> <p>REF 144TA4067 (rear, with bracket assembly) (Ø = 290,00 mm)</p>	<p>REF 164TA3083 (rubber) (450 x 84 x 56)</p>



USED FOR
CATERPILLAR



used for CATERPILLAR				
TRACK ROLLER	TOP ROLLER	SPROCKET	IDLER	TRACK
				
CATERPILLAR 247B				
<i>S/P: MTL - S/N: up to - 05074</i>				
REF 143TA8618 (Ø = 256,00 mm) (width = 72,00 mm) REF 163TA9845		REF 143TA9067	REF 143TA9325 (wheel only)	REF 143TA9688 (rubber) (380 x 101,6 x 42)
CATERPILLAR 257B				
<i>S/P: SLK - S/N: up to - 07299</i>				
REF 143TA8618 (Ø = 256,00 mm) (width = 72,00 mm) REF 163TA9845		REF 143TA9067	REF 143TA9325 (wheel only)	REF 143TA9688 (rubber) (380 x 101,6 x 42)
CATERPILLAR 259B3				
<i>S/P: YYZ</i>				
REF 143TA8619 (Ø flange = 215,50 mm) (Ø body = 201,00 mm)		REF 143TA9068	REF 143TA9583 (front, with bracket assembly) REF 143TA9595 (rear, with bracket assembly)	REF 164TA2025 (rubber) (400 x 86 x 53) REF 143TA9689 (rubber) (320 x 86 x 53)
CATERPILLAR 300.9D				
<i>S/P: LJ2</i>				
REF 164TA2089		REF 164TA2072	REF 163TA9865 (with bracket assembly)	REF 163TA9825 (rubber) (180 x 72 x 37) (with rail)
<i>S/P: LJM</i>				
REF 164TA2089		REF 164TA2072	REF 163TA9865 (with bracket assembly)	REF 163TA9825 (rubber) (180 x 72 x 37) (with rail)
CATERPILLAR 301.5				
<i>S/P: 3YW - S/N: up to - 03759</i>				
REF 144TA7419 (Ø flange = 94,00 mm) (Ø body = 75,00 mm)		REF 144TA7416 (number of teeth = 19) (number of holes = 9)	REF 163TA9456 (with bracket assembly) REF 144TA7424 (wheel only)	REF 143TA9670 (rubber) (230 x 96 x 31)
<i>S/P: 3YW - S/N: 03760 - and up</i>				
REF 144TA7418 (Ø flange = 111,00 mm) (Ø body = 75,00 mm) REF 144TA7419 (Ø flange = 94,00 mm) (Ø body = 75,00 mm)		REF 144TA7416 (number of teeth = 19) (number of holes = 9)	REF 163TA9456 (with bracket assembly) REF 144TA7424 (wheel only)	REF 143TA9670 (rubber) (230 x 96 x 31)
CATERPILLAR 301.6				
<i>S/P: BDH - S/N: up to - 00903</i>				
REF 144TA7419 (Ø flange = 94,00 mm) (Ø body = 75,00 mm)		REF 144TA7416 (number of teeth = 19) (number of holes = 9)	REF 163TA9456 (with bracket assembly) REF 144TA7424 (wheel only)	REF 164TA3041 (rubber) (230 x 96 x 33)
<i>S/P: BDH - S/N: 00904 - and up</i>				
REF 144TA7419 (Ø flange = 94,00 mm) (Ø body = 75,00 mm) REF 144TA7418 (Ø flange = 111,00 mm) (Ø body = 75,00 mm)		REF 144TA7416 (number of teeth = 19) (number of holes = 9)	REF 163TA9456 (with bracket assembly) REF 144TA7424 (wheel only)	REF 164TA3041 (rubber) (230 x 96 x 33)



used for CATERPILLAR				
TRACK ROLLER	TOP ROLLER	SPROCKET	IDLER	TRACK
				
CATERPILLAR 301.6C				
<i>S/P: JBB</i>				
REF 144TA7418 (Ø flange = 111,00 mm) (Ø body = 75,00 mm)		REF 144TA7416 (number of teeth = 19) (number of holes = 9)	REF 163TA9457 (with bracket assembly) REF 144TA7424 (wheel only)	REF 143TA9690 (rubber) (230 x 48 x 70)
CATERPILLAR 301.7D				
<i>S/P: LJ4</i>				
REF 163TA9846 (Ø flange = 116,00 mm) (Ø body = 80,00 mm)		REF 163TA9834 (number of teeth = 21) (number of holes = 9)	REF 163TA9459 (with bracket assembly) REF 163TA9876 (wheel only) (Ø = 281,00 mm)	REF 163TA9812 (rubber) (230 x 96 x 36)
<i>S/P: LJH</i>				
REF 163TA9846 (Ø flange = 116,00 mm) (Ø body = 80,00 mm)		REF 163TA9834 (number of teeth = 21) (number of holes = 9)	REF 163TA9459 (with bracket assembly) REF 163TA9876 (wheel only) (Ø = 281,00 mm)	REF 163TA9812 (rubber) (230 x 96 x 36)
CATERPILLAR 301.7DCR				
<i>S/P: LJ8</i>				
REF 163TA9846 (Ø flange = 116,00 mm) (Ø body = 80,00 mm)		REF 163TA9834 (number of teeth = 21) (number of holes = 9)	REF 163TA9459 (with bracket assembly) REF 163TA9876 (wheel only) (Ø = 281,00 mm)	REF 163TA9812 (rubber) (230 x 96 x 36)
<i>S/P: LJD</i>				
REF 163TA9846 (Ø flange = 116,00 mm) (Ø body = 80,00 mm)		REF 163TA9834 (number of teeth = 21) (number of holes = 9)	REF 163TA9459 (with bracket assembly) REF 163TA9876 (wheel only) (Ø = 281,00 mm)	REF 163TA9812 (rubber) (230 x 96 x 36)
CATERPILLAR 301.8				
<i>S/P: BFA - S/N: up to - 02418</i>				
REF 144TA7419 (Ø flange = 94,00 mm) (Ø body = 75,00 mm)		REF 144TA7416 (number of teeth = 19) (number of holes = 9)	REF 163TA9456 (with bracket assembly) REF 144TA7424 (wheel only)	REF 164TA3041 (rubber) (230 x 96 x 33) REF 163TA9813 (rubber) (230 x 48 x 66)
<i>S/P: BFA - S/N: 02419 - and up</i>				
REF 144TA7419 (Ø flange = 94,00 mm) (Ø body = 75,00 mm)		REF 144TA7416 (number of teeth = 19) (number of holes = 9)	REF 163TA9456 (with bracket assembly) REF 144TA7424 (wheel only)	REF 164TA3041 (rubber) (230 x 96 x 33) REF 163TA9813 (rubber) (230 x 48 x 66)
REF 144TA7418 (Ø flange = 111,00 mm) (Ø body = 75,00 mm)				
CATERPILLAR 301.8C				
<i>S/P: JSB</i>				
REF 144TA7418 (Ø flange = 111,00 mm) (Ø body = 75,00 mm)		REF 144TA7416 (number of teeth = 19) (number of holes = 9)	REF 163TA9457 (with bracket assembly) REF 144TA7424 (wheel only)	REF 143TA9690 (rubber) (230 x 48 x 70)







used for CATERPILLAR				
TRACK ROLLER	TOP ROLLER	SPROCKET	IDLER	TRACK
				
CATERPILLAR 302.5				
<i>S/P: 4AZ</i>				
REF 144TA7425 (Ø flange = 118,00 mm) (Ø body = 94,00 mm)	REF 144TA7422 (assembly) (Ø body = 75,00 mm)	REF 144TA7401 (number of teeth = 21) (number of holes = 13)	REF 163TA9860 (with bracket assembly) (Ø = 330,00 mm)	REF 164TA3018 (rubber) (300 x 52,5 x 78)
CATERPILLAR 302.5C				
<i>S/P: GBB</i>				
REF 144TA7420 (Ø flange = 114,00 mm) (Ø body = 85,00 mm)	REF 144TA7422 (assembly) (Ø body = 75,00 mm)	REF 144TA7402 (number of teeth = 21) (number of holes = 13)	REF 163TA9464 (with bracket assembly) REF 163TA9877 (wheel only)	REF 164TA3018 (rubber) (300 x 52,5 x 78)
CATERPILLAR 302.7D				
<i>S/P: LJ7</i>				
REF 163TA9848	REF 163TA9854 (assembly) (Ø body = 82,00 mm)	REF 163TA9836	REF 163TA9861 (with bracket assembly)	REF 163TA9817 (rubber) (300 x 109 x 40)
<i>S/P: LJL</i>				
REF 163TA9848	REF 163TA9854 (assembly) (Ø body = 82,00 mm)	REF 163TA9836	REF 163TA9861 (with bracket assembly)	REF 163TA9817 (rubber) (300 x 109 x 40)
CATERPILLAR 303 CR				
<i>S/P: DMA</i>				
REF 144TA7425 (Ø flange = 118,00 mm) (Ø body = 94,00 mm)	REF 163TA9855 (assembly) (Ø body = 75,00 mm)	REF 163TA9837 (number of teeth = 21) (number of holes = 9)	REF 163TA9862 (with bracket assembly)	REF 164TA3081 (rubber) (300 x 52,5 x 84)
CATERPILLAR 303.5				
<i>S/P: AFW</i>				
REF 144TA7425 (Ø flange = 118,00 mm) (Ø body = 94,00 mm)	REF 144TA7422 (assembly) (Ø body = 75,00 mm)	REF 144TA7403 (number of teeth = 21) (number of holes = 9)	REF 144TA7388 (front, with bracket assembly) (Ø = 330,00 mm)	REF 164TA3081 (rubber) (300 x 52,5 x 84)
<i>S/P: DCH</i>				
REF 144TA7425 (Ø flange = 118,00 mm) (Ø body = 94,00 mm)	REF 144TA7422 (assembly) (Ø body = 75,00 mm)	REF 144TA7404 (number of teeth = 21) (number of holes = 9)	REF 144TA7389 (front, with bracket assembly)	REF 164TA3081 (rubber) (300 x 52,5 x 84)
CATERPILLAR 303.5C				
<i>S/P: DMY</i>				
REF 144TA7420 (Ø flange = 114,00 mm) (Ø body = 85,00 mm)	REF 144TA7405 (assembly) (Ø body = 70,00 mm)	REF 143TA9071 (number of teeth = 23) (number of holes = 11)	REF 163TA9866 (with bracket assembly)	REF 163TA9830 (rubber) (300 x 52,5 x 90)
CATERPILLAR 303.5D				
<i>S/P: RHP</i>				
REF 144TA7420 (Ø flange = 114,00 mm) (Ø body = 85,00 mm)	REF 163TA9859 (assembly) (Ø body = 67,70 mm)	REF 143TA9071 (number of teeth = 23) (number of holes = 11)	REF 163TA9867 (with bracket assembly)	REF 163TA9827 (rubber) (300 x 52,5 x 90)
CATERPILLAR 303.5E				
<i>S/P: BG8</i>				
REF 164TA2092	REF 164TA2113 (assembly)	REF 164TA2073	REF 163TA9868 (with bracket assembly)	REF 163TA9828 (rubber) (300 x 52,5 x 90)



used for CATERPILLAR				
TRACK ROLLER	TOP ROLLER	SPROCKET	IDLER	TRACK
				
CATERPILLAR 303CCR				
<i>S/P: BXT</i>				
REF 144TA7420 (∅ flange = 114,00 mm) (∅ body = 85,00 mm)	REF 144TA7406 (assembly) (∅ body = 70,00 mm)	REF 143TA9071 (number of teeth = 23) (number of holes = 11)	REF 163TA9458 (with bracket assembly) REF 163TA9296 (front, with bracket assembly) REF 143TA9329 (wheel only) (∅ = 345,00 mm)	REF 163TA9830 (rubber) (300 x 52,5 x 90)
CATERPILLAR 304				
<i>S/P: NAD - S/N: up to - 00843</i>				
REF 144TA7417 (∅ flange = 134,00 mm) (∅ body = 100,00 mm)	REF 163TA9856 (assembly) (∅ body = 80,00 mm)	REF 163TA9839 (number of teeth = 19) (number of holes = 9)	REF 163TA9863 (with bracket assembly)	REF 164TA2024 (rubber) (400 x 72,5 x 72) REF 143TA9695 (steel) (width = 400,00 mm) (number of links = 38)
<i>S/P: NAD - S/N: 00844 - and up</i>				
REF 144TA7417 (∅ flange = 134,00 mm) (∅ body = 100,00 mm)	REF 163TA9856 (assembly) (∅ body = 80,00 mm)	REF 163TA9839 (number of teeth = 19) (number of holes = 9)	REF 163TA9864 (with bracket assembly)	REF 164TA2024 (rubber) (400 x 72,5 x 72) REF 143TA9695 (steel) (width = 400,00 mm) (number of links = 38)
CATERPILLAR 304.5				
<i>S/P: ANR - S/N: up to - 01023</i>				
REF 144TA7417 (∅ flange = 134,00 mm) (∅ body = 100,00 mm)	REF 163TA9856 (assembly) (∅ body = 80,00 mm)	REF 163TA9839 (number of teeth = 19) (number of holes = 9)	REF 163TA9453 (with bracket assembly)	REF 163TA9820 (rubber) (400 x 72,5 x 72)
<i>S/P: ANR - S/N: 01024 - and up</i>				
REF 144TA7417 (∅ flange = 134,00 mm) (∅ body = 100,00 mm)	REF 163TA9856 (assembly) (∅ body = 80,00 mm)	REF 163TA9839 (number of teeth = 19) (number of holes = 9)	REF 163TA9454 (with bracket assembly)	REF 163TA9820 (rubber) (400 x 72,5 x 72)
<i>S/P: WAK</i>				
REF 144TA7417 (∅ flange = 134,00 mm) (∅ body = 100,00 mm)	REF 163TA9856 (assembly) (∅ body = 80,00 mm)	REF 163TA9839 (number of teeth = 19) (number of holes = 9)	REF 163TA9869 (with bracket assembly)	REF 163TA9820 (rubber) (400 x 72,5 x 72)
CATERPILLAR 304CCR				
<i>S/P: FPK - S/N: up to - 02192</i>				
REF 144TA7421 (∅ flange = 133,80 mm) (∅ body = 100,50 mm)	REF 144TA7423 (assembly) (∅ body = 70,00 mm)	REF 143TA9073 (number of teeth = 19) (number of holes = 12)	REF 163TA9462 (with bracket assembly) REF 163TA9882 (wheel only)	REF 163TA9819 (rubber) (400 x 72,5 x 76)
<i>S/P: FPK - S/N: 02193 - and up</i>				
REF 144TA7421 (∅ flange = 133,80 mm) (∅ body = 100,50 mm)	REF 144TA7423 (assembly) (∅ body = 70,00 mm)	REF 163TA9839 (number of teeth = 19) (number of holes = 9)	REF 163TA9462 (with bracket assembly) REF 163TA9882 (wheel only)	REF 163TA9819 (rubber) (400 x 72,5 x 76)







used for CATERPILLAR				
TRACK ROLLER	TOP ROLLER	SPROCKET	IDLER	TRACK
				
CATERPILLAR 304CR				
<i>S/P: BTN</i>				
REF 144TA7417 (Ø flange = 134,00 mm) (Ø body = 100,00 mm)	REF 144TA7410 (assembly) (Ø body = 80,00 mm)			REF 163TA9820 (rubber) (400 x 72,5 x 92)
CATERPILLAR 304D CR				
<i>S/P: TYK</i>				
REF 144TA7420 (Ø flange = 114,00 mm) (Ø body = 85,00 mm)	REF 163TA9859 (assembly) (Ø body = 67,70 mm)	REF 163TA9842	REF 163TA9174 (front, with bracket assembly)	REF 163TA9830 (rubber) (300 x 52,5 x 90)
CATERPILLAR 304E2 CR				
<i>S/P: CJ2</i>				
REF 164TA2092	REF 164TA2113 (assembly)	REF 164TA2073	REF 163TA9175 (front, with bracket assembly)	REF 163TA9831 (rubber) (350 x 52,5 x 90)
CATERPILLAR 305				
<i>S/P: DGT</i>				
REF 163TA9849 (Ø flange = 134,00 mm) (Ø body = 100,00 mm)	REF 144TA7413 (assembly) (for steel tracks) (Ø body = 80,00 mm) REF 163TA9856 (assembly) (Ø body = 80,00 mm)	REF 163TA9839 (number of teeth = 19) (number of holes = 9)	REF 163TA9460 (with bracket assembly) REF 144TA7394 (front, with bracket assembly) (for steel tracks) REF 163TA9878 (wheel only)	REF 163TA9821 (rubber) (400 x 72,5 x 92)
<i>S/P: DSA - S/N: up to - 00154</i>				
REF 163TA9849 (Ø flange = 134,00 mm) (Ø body = 100,00 mm)	REF 144TA7414 (assembly) (for steel tracks) (Ø body = 80,00 mm) REF 163TA9856 (assembly) (Ø body = 80,00 mm)	REF 163TA9839 (number of teeth = 19) (number of holes = 9)	REF 163TA9453 (with bracket assembly) REF 163TA9879 (wheel only) REF 144TA7395 (front, with bracket assembly) (for steel tracks)	REF 163TA9821 (rubber) (400 x 72,5 x 92)
<i>S/P: DSA - S/N: 00155 - 00844</i>				
REF 163TA9849 (Ø flange = 134,00 mm) (Ø body = 100,00 mm)	REF 144TA7414 (assembly) (for steel tracks) (Ø body = 80,00 mm) REF 163TA9856 (assembly) (Ø body = 80,00 mm)	REF 163TA9839 (number of teeth = 19) (number of holes = 9)	REF 163TA9454 (with bracket assembly) REF 163TA9880 (wheel only) REF 144TA7395 (front, with bracket assembly) (for steel tracks)	REF 163TA9821 (rubber) (400 x 72,5 x 92)
<i>S/P: DSA - S/N: 00845 - and up</i>				
REF 163TA9849 (Ø flange = 134,00 mm) (Ø body = 100,00 mm)	REF 144TA7414 (assembly) (for steel tracks) (Ø body = 80,00 mm) REF 163TA9856 (assembly) (Ø body = 80,00 mm)	REF 163TA9839 (number of teeth = 19) (number of holes = 9)	REF 163TA9460 (with bracket assembly) REF 163TA9878 (wheel only) REF 144TA7395 (front, with bracket assembly) (for steel tracks)	REF 163TA9821 (rubber) (400 x 72,5 x 92)



used for CATERPILLAR				
TRACK ROLLER	TOP ROLLER	SPROCKET	IDLER	TRACK
				
CATERPILLAR 305.5				
<i>S/P: CXZ</i>				
REF 144TA7417 (Ø flange = 134,00 mm) (Ø body = 100,00 mm)	REF 144TA7411 (assembly) (for steel tracks) (Ø body = 80,00 mm) REF 163TA9856 (assembly) (Ø body = 80,00 mm)	REF 163TA9839 (number of teeth = 19) (number of holes = 9)	REF 163TA9460 (with bracket assembly) REF 144TA7392 (front, with bracket assembly) (for steel tracks) REF 163TA9878 (wheel only)	REF 163TA9820 (rubber) (400 x 72,5 x 72)
<i>S/P: DCK</i>				
REF 144TA7417 (for steel tracks) (Ø flange = 134,00 mm) (Ø body = 100,00 mm) REF 163TA9849 (Ø flange = 134,00 mm) (Ø body = 100,00 mm)	REF 144TA7412 (assembly) (for steel tracks) (Ø body = 80,00 mm) REF 163TA9856 (assembly) (Ø body = 80,00 mm)	REF 163TA9839 (number of teeth = 19) (number of holes = 9)	REF 163TA9460 (with bracket assembly) REF 144TA7393 (front, with bracket assembly) (for steel tracks) REF 163TA9878 (wheel only)	REF 163TA9820 (rubber) (400 x 72,5 x 72)
CATERPILLAR 305.5D				
<i>S/P: FLZ</i>				
REF 144TA7421 (Ø flange = 133,80 mm) (Ø body = 100,50 mm)	REF 144TA7423 (assembly) (Ø body = 70,00 mm)	REF 163TA9840	REF 163TA9870 (front, with bracket assembly)	REF 163TA9818 (rubber) (400 x 72,5 x 76)
CATERPILLAR 305.5E2 CR				
<i>S/P: EJX</i>				
REF 163TA9850 (for steel tracks)	REF 163TA9857 (assembly) (for steel tracks)	REF 143TA9073 (for steel tracks) (number of teeth = 19) (number of holes = 12)	REF 163TA9172 (front, with bracket assembly) (for steel tracks)	
CATERPILLAR 305C				
<i>S/P: HWJ</i>				
REF 144TA7421 (Ø flange = 133,80 mm) (Ø body = 100,50 mm)	REF 144TA7423 (assembly) (Ø body = 70,00 mm)	REF 143TA9073 (number of teeth = 19) (number of holes = 12)		REF 163TA9818 (rubber) (400 x 72,5 x 76)
CATERPILLAR 305C CR				
<i>S/P: HWJ</i>				
REF 144TA7421 (Ø flange = 133,80 mm) (Ø body = 100,50 mm)	REF 144TA7423 (assembly) (Ø body = 70,00 mm)	REF 163TA9840	REF 163TA9173 (front, with bracket assembly)	REF 163TA9819 (rubber) (400 x 72,5 x 76)
CATERPILLAR 305D				
<i>S/P: XER</i>				
REF 144TA7421 (Ø flange = 133,80 mm) (Ø body = 100,50 mm)	REF 144TA7423 (assembly) (Ø body = 70,00 mm)	REF 163TA9843	REF 163TA9872 (front, with bracket assembly)	REF 163TA9819 (rubber) (400 x 72,5 x 76)
CATERPILLAR 305E				
<i>S/P: WDL</i>				
REF 144TA7421 (Ø flange = 133,80 mm) (Ø body = 100,50 mm)	REF 144TA7423 (assembly) (Ø body = 70,00 mm)	REF 163TA9839 (number of teeth = 19) (number of holes = 9)	REF 163TA9873 (front, with bracket assembly)	REF 164TA2026 (rubber)
<i>S/P: XFA</i>				
REF 144TA7421 (Ø flange = 133,80 mm) (Ø body = 100,50 mm)	REF 144TA7423 (assembly) (Ø body = 70,00 mm)	REF 163TA9839 (number of teeth = 19) (number of holes = 9)	REF 163TA9874 (front, with bracket assembly)	REF 163TA9819 (rubber) (400 x 72,5 x 76)



used for CATERPILLAR				
TRACK ROLLER	TOP ROLLER	SPROCKET	IDLER	TRACK
				
<i>S/P: XSC</i>				
REF 144TA7421 (Ø flange = 133,80 mm) (Ø body = 100,50 mm)	REF 144TA7423 (assembly) (Ø body = 70,00 mm)	REF 163TA9839 (number of teeth = 19) (number of holes = 9)	REF 163TA9875 (front, with bracket assembly)	REF 163TA9819 (rubber) (400 x 72,5 x 76)
CATERPILLAR 305E CR				
<i>S/P: DJX</i>				
REF 163TA9850	REF 163TA9857 (assembly)	REF 143TA9073 (number of teeth = 19) (number of holes = 12)	REF 163TA9172 (with bracket assembly) REF 163TA9883 (wheel only)	REF 163TA9832 (rubber)
CATERPILLAR 306				
<i>S/P: MXH</i>				
REF 163TA9849 (for steel tracks) (Ø flange = 134,00 mm) (Ø body = 100,00 mm)	REF 163TA9858 (assembly) (for steel tracks) (Ø flange = 105,00 mm) (Ø body = 85,00 mm)	REF 163TA9839 (for steel tracks) (number of teeth = 19) (number of holes = 9)	REF 163TA9460 (with bracket assembly) (for steel tracks) REF 144TA7400 (front, with bracket assembly) (for steel tracks) REF 163TA9878 (wheel only) (for steel tracks)	
CATERPILLAR 307				
<i>S/P: 2WM</i>				
REF 163TA9851 (Ø flange = 144,00 mm) (Ø body = 120,00 mm) REF 163TA9852	REF 144TA7415 (assembly) (Ø flange = 105,00 mm) (Ø body = 85,00 mm)	REF 163TA9841 (number of teeth = 23) (number of holes = 12)	REF 163TA9461 (with bracket assembly) REF 163TA9881 (wheel only) (Ø = 450,00 mm)	REF 163TA9822 (rubber) (450 x 71 x 82)
CATERPILLAR 307B				
<i>S/P: AFB</i>				
REF 163TA9853 (Ø flange = 144,00 mm) (Ø body = 120,00 mm)	REF 144TA7415 (assembly) (Ø flange = 105,00 mm) (Ø body = 85,00 mm)	REF 163TA9841 (number of teeth = 23) (number of holes = 12)	REF 163TA9461 (with bracket assembly) REF 163TA9881 (wheel only) (Ø = 450,00 mm)	REF 163TA9833 (rubber) (450 x 71 x 82)
CATERPILLAR 307D				
<i>S/P: DSG - S/N: up to - 03379</i>				
REF 163TA9853 (Ø flange = 144,00 mm) (Ø body = 120,00 mm)	REF 163TA9858 (assembly) (Ø flange = 105,00 mm) (Ø body = 85,00 mm)	REF 163TA9844	REF 164TA1536 (with bracket assembly) (Ø = 450,00 mm) REF 164TA1537 (wheel only)	
<i>S/P: DSG - S/N: 03380 - and up</i>				
REF 164TA1538	REF 163TA9858 (assembly) (Ø flange = 105,00 mm) (Ø body = 85,00 mm)	REF 163TA9844	REF 164TA1536 (with bracket assembly) (Ø = 450,00 mm) REF 164TA1537 (wheel only)	



used for **CATERPILLAR**

TRACK ROLLER	TOP ROLLER	SPROCKET	IDLER	TRACK
				

CATERPILLAR 308C

S/P: KCX

<p>REF 163TA9853 (Ø flange = 144,00 mm) (Ø body = 120,00 mm)</p>	<p>REF 163TA9858 (assembly) (Ø flange = 105,00 mm) (Ø body = 85,00 mm)</p>	<p>REF 164TA2074</p>	<p>REF 164TA1536 (with bracket assembly) (Ø = 450,00 mm)</p> <p>REF 164TA1537 (wheel only)</p>	<p>REF 164TA1535 (rubber) (width = 450,00 mm) (number of links = 40) (with rubber pads)</p>
---	---	---	--	--

used for CATERPILLAR



USED FOR
DAEWOO



used for DAEWOO				
TRACK ROLLER	TOP ROLLER	SPROCKET	IDLER	TRACK
				
DAEWOO SOLAR015				
REF 144TA7880 (Ø flange = 98,00 mm) (Ø body = 80,00 mm)		REF 163TA9158	REF 143TA9332 (front, with bracket assembly)	REF 164TA9692 (rubber) (230 x 96 x 33)
DAEWOO SOLAR015-Plus				
REF 143TA8626		REF 144TA7678 (number of teeth = 19) (number of holes = 9)	REF 143TA9332 (front, with bracket assembly)	REF 164TA9692 (rubber) (230 x 96 x 33)
DAEWOO SOLAR030				
REF 163TA9791 (for steel tracks)		REF 144TA7679 (number of teeth = 21) (number of holes = 12)	REF 144TA7592 (front, with bracket assembly) (Ø = 311,00 mm)	REF 143TA9698 (rubber) (300 x 52,5 x 76)
REF 144TA7881 (Ø flange = 133,00 mm) (Ø body = 95,00 mm)			REF 163TA9810 (front, with bracket assembly) (for steel tracks)	
DAEWOO SOLAR030-Plus				
REF 144TA7882 (Ø flange = 133,00 mm) (Ø body = 95,00 mm)		REF 144TA7680 (number of teeth = 21) (number of holes = 12)	REF 144TA7593 (front, with bracket assembly) (Ø = 311,00 mm)	REF 143TA9698 (rubber) (300 x 52,5 x 76)
DAEWOO SOLAR035				
REF 144TA7884 (for steel tracks) (Ø flange = 115,00 mm) (Ø body = 95,00 mm)		REF 144TA7681 (number of teeth = 21) (number of holes = 12)	REF 144TA7594 (front, with bracket assembly) (Ø = 311,00 mm)	REF 143TA9699 (rubber) (300 x 52,5 x 84)
REF 144TA7883 (Ø flange = 133,00 mm) (Ø body = 95,00 mm)			REF 163TA9810 (front, with bracket assembly) (for steel tracks)	
DAEWOO SOLAR50				
REF 144TA7885			REF 144TA7595 (front, with bracket assembly) (Ø = 385,00 mm)	
DAEWOO SOLAR55				
REF 144TA7886 (Ø flange = 128,00 mm) (Ø body = 94,00 mm)	REF 144TA7760 (assembly) (Ø flange = 128,00 mm) (Ø body = 94,00 mm)	REF 144TA7682 (number of teeth = 19) (number of holes = 9)	REF 144TA7596 (front, with bracket assembly)	REF 143TA9701 (rubber) (400 x 72,5 x 74)
DAEWOO SOLAR55V-Plus				
REF 144TA7887 (Ø flange = 128,00 mm) (Ø body = 94,00 mm)	REF 144TA7761 (assembly) (Ø flange = 128,00 mm) (Ø body = 94,00 mm)	REF 144TA7683 (number of holes = 12)	REF 144TA7597 (front, with bracket assembly)	REF 143TA9701 (rubber) (400 x 72,5 x 74)
DAEWOO SOLAR70-III				
REF 163TA9793 (for rubber tracks)	REF 163TA9257 (assembly) (Ø body = 100,00 mm)	REF 163TA9787 (number of teeth = 21) (number of holes = 12)	REF 143TA9291 (front, with bracket assembly)	REF 143TA9696 (rubber) (450 x 81 x 74)
REF 163TA9794 (for steel tracks)				



USED FOR
DOOSAN

TRACKS & UNDERCARRIAGE PARTS





used for DOOSAN

used for DOOSAN				
TRACK ROLLER	TOP ROLLER	SPROCKET	IDLER	TRACK
				
DOOSAN DH70				
REF 163TA9164	REF 163TA9165 (assembly)	REF 163TA9160	REF 163TA9168 (with bracket assembly)	
DOOSAN DX15				
REF 163TA9797 (standard and variable tracks)		REF 144TA1908 (number of teeth = 19) (number of holes = 9)	REF 163TA9261 (with bracket assembly)	REF 163TA9153 (rubber) (230 x 96 x 35)
DOOSAN DX18				
REF 163TA9797 (standard and variable tracks)		REF 144TA1908 (number of teeth = 19) (number of holes = 9)	REF 163TA9261 (with bracket assembly)	REF 163TA9153 (rubber) (230 x 96 x 35)
DOOSAN DX225LC (DI EXP)				
S/N: 05001 - 05427				
REF 164TA2095	REF 163TA9303 (assembly)	REF 164TA2075 (number of teeth = 21)		
S/N: 05001 - 05813				
		REF 164TA2075 (number of teeth = 21)	REF 164TA2124 (with bracket assembly)	
S/N: 05428 - 05432				
REF 164TA2097		REF 164TA2075 (number of teeth = 21)		
S/N: 05428 - and up				
	REF 164TA2116 (assembly)	REF 164TA2075 (number of teeth = 21)		
S/N: 05433 - and up				
REF 164TA2098				
S/N: 05814 - and up				
		REF 164TA2075 (number of teeth = 21)	REF 164TA2125 (with bracket assembly)	
DOOSAN DX225LC (DIEU EXP)				
S/N: 50001 - 50640				
REF 164TA2095	REF 163TA9303 (assembly)	REF 164TA2075 (number of teeth = 21)	REF 164TA2124 (with bracket assembly)	
S/N: 50641 - and up				
REF 164TA2096	REF 163TA9166 (assembly)	REF 164TA2075 (number of teeth = 21)	REF 164TA2124 (with bracket assembly)	
DOOSAN DX225LCA				
S/N: 05001 - 06978				
REF 164TA2098	REF 164TA2116 (assembly)		REF 164TA2125 (with bracket assembly)	
S/N: 05001 - and up				
REF 164TA2098			REF 164TA2125 (with bracket assembly)	
S/N: 06979 - and up				
	REF 164TA2117 (assembly)			
DOOSAN DX27Z				
S/N: 05001 - 05252				
REF 143TA8629	REF 143TA8911 (assembly) (Ø body = 70,00 mm)	REF 143TA9076	REF 143TA9335 (with bracket assembly)	REF 144TA1050 (rubber) (250 x 52,5 x 80)

TRACKS & UNDERCARRIAGE PARTS







used for DOOSAN

used for DOOSAN				
TRACK ROLLER	TOP ROLLER	SPROCKET	IDLER	TRACK
				
<i>S/N: 05001 - 05399</i>				
	REF 143TA8911 (assembly) (∅ body = 70,00 mm)	REF 143TA9076	REF 143TA9335 (with bracket assembly)	REF 144TA1051 (rubber) (300 x 52,5 x 80) REF 144TA1050 (rubber) (250 x 52,5 x 80)
<i>S/N: 05253 - and up</i>				
REF 163TA9162	REF 143TA8911 (assembly) (∅ body = 70,00 mm)	REF 143TA9076	REF 143TA9335 (with bracket assembly)	REF 144TA1050 (rubber) (250 x 52,5 x 80)
<i>S/N: 05400 - and up</i>				
	REF 143TA8911 (assembly) (∅ body = 70,00 mm)	REF 143TA9076	REF 143TA9335 (with bracket assembly)	REF 163TA9155 (rubber) (300 x 52,5 x 80) REF 144TA1050 (rubber) (250 x 52,5 x 80)
DOOSAN DX30Z				
<i>S/N: 05001 - 05108</i>				
REF 163TA9162	REF 143TA8911 (assembly) (∅ body = 70,00 mm)	REF 163TA9334	REF 163TA9167 (with bracket assembly)	REF 163TA9157 (rubber) (300 x 52,5 x 84)
<i>S/N: 05109 - and up</i>				
REF 163TA9162	REF 143TA8911 (assembly) (∅ body = 70,00 mm)	REF 163TA9334	REF 163TA9167 (with bracket assembly)	REF 163TA9455 (rubber) (300 x 52,5 x 84)
DOOSAN DX340LC				
<i>S/N: 05001 - 06206</i>				
REF 164TA2094	REF 163TA9304 (assembly)	REF 163TA9260		
<i>S/N: 05001 - 06316</i>				
REF 164TA2094		REF 163TA9260	REF 163TA9291 (with bracket assembly)	
<i>S/N: 06207 - 06397</i>				
REF 164TA2094	REF 164TA2114 (assembly)	REF 163TA9260		
<i>S/N: 06317 - and up</i>				
REF 164TA2094		REF 163TA9260	REF 163TA9809 (with bracket assembly)	
<i>S/N: 06398 - and up</i>				
REF 164TA2094	REF 164TA2115 (assembly)	REF 163TA9260		
DOOSAN DX340LCA				
REF 164TA2094	REF 164TA2114 (assembly)	REF 163TA9260	REF 163TA9809 (with bracket assembly)	
DOOSAN DX35Z				
<i>S/N: 05001 - 05519</i>				
REF 143TA8630 (∅ flange = 133,00 mm) (∅ body = 95,00 mm)	REF 143TA8912 (assembly) (∅ body = 79,00 mm)	REF 143TA9077	REF 143TA9336 (with bracket assembly)	REF 143TA9703 (rubber) (300 x 52,5 x 86)
<i>S/N: 05520 - and up</i>				
REF 143TA8630 (∅ flange = 133,00 mm) (∅ body = 95,00 mm)	REF 143TA8912 (assembly) (∅ body = 79,00 mm)	REF 143TA9077	REF 143TA9336 (with bracket assembly)	REF 163TA9778 (rubber) (300 x 52,5 x 86)





TRACKS & UNDERCARRIAGE PARTS



used for DOOSAN





used for DOOSAN				
TRACK ROLLER	TOP ROLLER	SPROCKET	IDLER	TRACK
				
DOOSAN DX55				
<i>S/N: 50001 - 50309</i>				
	REF 144TA7700 (assembly) (Ø flange = 128,00 mm) (Ø body = 94,00 mm)		REF 164TA2123 (with bracket assembly)	REF 163TA9777 (rubber) (400 x 72,5 x 74)
<i>S/N: 50001 - 50310</i>				
REF 144TA7787 (Ø flange = 140,00 mm) (Ø body = 110,00 mm)	REF 144TA7700 (assembly) (Ø flange = 128,00 mm) (Ø body = 94,00 mm)			REF 163TA9777 (rubber) (400 x 72,5 x 74)
<i>S/N: 50001 - 50313</i>				
	REF 144TA7700 (assembly) (Ø flange = 128,00 mm) (Ø body = 94,00 mm)	REF 144TA7624 (number of teeth = 19) (number of holes = 9)		REF 163TA9777 (rubber) (400 x 72,5 x 74)
<i>S/N: 50310 - and up</i>				
	REF 144TA7700 (assembly) (Ø flange = 128,00 mm) (Ø body = 94,00 mm)		REF 144TA7510 (with bracket assembly)	REF 163TA9777 (rubber) (400 x 72,5 x 74)
<i>S/N: 50311 - and up</i>				
REF 163TA9795	REF 144TA7700 (assembly) (Ø flange = 128,00 mm) (Ø body = 94,00 mm)			REF 163TA9777 (rubber) (400 x 72,5 x 74)
<i>S/N: 50314 - and up</i>				
	REF 144TA7700 (assembly) (Ø flange = 128,00 mm) (Ø body = 94,00 mm)	REF 144TA1800 (number of teeth = 19) (number of holes = 9)		REF 163TA9777 (rubber) (400 x 72,5 x 74)
DOOSAN DX60R				
<i>S/N: 50001 - 50286</i>				
REF 144TA7788 (for steel tracks) (Ø flange = 140,00 mm) (Ø body = 110,00 mm)	REF 144TA7701 (assembly) (Ø flange = 128,00 mm) (Ø body = 94,00 mm)		REF 144TA7511 (with bracket assembly)	
<i>S/N: 50001 - 50463</i>				
REF 143TA8579 (Ø flange = 128,00 mm) (Ø body = 94,00 mm)	REF 144TA7701 (assembly) (Ø flange = 128,00 mm) (Ø body = 94,00 mm)			
REF 144TA7788 (for steel tracks) (Ø flange = 140,00 mm) (Ø body = 110,00 mm)				
<i>S/N: 50001 - and up</i>				
REF 144TA7788 (for steel tracks) (Ø flange = 140,00 mm) (Ø body = 110,00 mm)	REF 144TA7701 (assembly) (Ø flange = 128,00 mm) (Ø body = 94,00 mm)	REF 144TA7626 (number of holes = 12)		REF 143TA9609 (rubber) (400 x 72,5 x 76)
<i>S/N: 50287 - 50463</i>				
REF 144TA7788 (for steel tracks) (Ø flange = 140,00 mm) (Ø body = 110,00 mm)	REF 144TA7701 (assembly) (Ø flange = 128,00 mm) (Ø body = 94,00 mm)		REF 163TA9805 (with bracket assembly)	



used for DOOSAN				
TRACK ROLLER	TOP ROLLER	SPROCKET	IDLER	TRACK
				
<i>S/N: 50464 - and up</i>				
REF 163TA9796	REF 144TA7701 (assembly) (Ø flange = 128,00 mm) (Ø body = 94,00 mm)		REF 163TA9806 (with bracket assembly)	
REF 144TA7788 (for steel tracks) (Ø flange = 140,00 mm) (Ø body = 110,00 mm)				
DOOSAN DX80R				
<i>S/N: 50001 - and up</i>				
REF 143TA8581	REF 163TA9801 (assembly)	REF 163TA9463	REF 163TA9169 (with bracket assembly)	REF 163TA9780 (rubber) (450 x 81 x 76)
DOOSAN SOLAR 75 V (DI EXP)				
<i>S/N: 01001 - 01148</i>				
REF 163TA9263				REF 143TA9696 (rubber) (450 x 81 x 74)
<i>S/N: 01001 - 01163</i>				
		REF 163TA9452	REF 163TA9443 (with bracket assembly) (for steel tracks)	REF 143TA9696 (rubber) (450 x 81 x 74)
<i>S/N: 01001 - and up</i>				
REF 163TA9262 (for steel tracks)	REF 163TA9257 (assembly) (Ø body = 100,00 mm)	REF 163TA9259 (for steel tracks) (number of teeth = 21) (number of holes = 12)	REF 163TA9169 (with bracket assembly)	REF 143TA9696 (rubber) (450 x 81 x 74)
<i>S/N: 01149 - 01163</i>				
REF 164TA2093				REF 143TA9696 (rubber) (450 x 81 x 74)
<i>S/N: 01164 - and up</i>				
REF 163TA9263		REF 163TA9463	REF 143TA9292 (with bracket assembly) (for steel tracks)	REF 143TA9696 (rubber) (450 x 81 x 74)
DOOSAN SOLAR 75 V (DIEU EXP)				
<i>S/N: 50001 - 50060</i>				
REF 164TA2093	REF 163TA9257 (assembly) (Ø body = 100,00 mm)	REF 163TA9452	REF 163TA9443 (with bracket assembly) (for steel tracks)	REF 143TA9696 (rubber) (450 x 81 x 74)
REF 163TA9262 (for steel tracks)		REF 163TA9259 (for steel tracks) (number of teeth = 21) (number of holes = 12)	REF 163TA9169 (with bracket assembly)	
<i>S/N: 50061 - and up</i>				
REF 163TA9799	REF 163TA9257 (assembly) (Ø body = 100,00 mm)	REF 163TA9463	REF 143TA9292 (with bracket assembly) (for steel tracks)	REF 143TA9696 (rubber) (450 x 81 x 74)
REF 163TA9262 (for steel tracks)		REF 163TA9259 (for steel tracks) (number of teeth = 21) (number of holes = 12)	REF 163TA9169 (with bracket assembly)	
DOOSAN SOLAR010				
<i>S/N: up to - 00315</i>				
REF 163TA9798		REF 163TA9789	REF 163TA9807 (with bracket assembly)	REF 163TA9781 (rubber) (180 x 72 x 37)



used for DOOSAN

used for DOOSAN				
TRACK ROLLER	TOP ROLLER	SPROCKET	IDLER	TRACK
				
<i>S/N: 00316 - and up</i>				
REF 163TA9798		REF 163TA9789	REF 163TA9807 (with bracket assembly)	REF 163TA9782 (rubber) (180 x 72 x 37)
DOOSAN SOLAR018VT				
<i>S/N: 30001 - 30997</i>				
REF 163TA9797		REF 144TA1908 (number of teeth = 19) (number of holes = 9)	REF 163TA9261 (with bracket assembly)	REF 163TA9153 (rubber) (230 x 96 x 35)
<i>S/N: 30998 - and up</i>				
REF 163TA9797		REF 144TA1908 (number of teeth = 19) (number of holes = 9)	REF 163TA9261 (with bracket assembly)	REF 163TA9156 (rubber) (230 x 96 x 35)



USED FOR
FAI



used for FAI

used for FAI				
TRACK ROLLER	TOP ROLLER	SPROCKET	IDLER	TRACK
				
FAI 212				
			REF 144TA7549 (front, with bracket assembly) (for rubber tracks)	REF 143TA9704 (rubber) (230 x 96 x 31)
FAI 222				
REF 144TA7827 (for rubber tracks) (Ø flange = 115,00 mm) (Ø body = 85,00 mm)		REF 144TA7655 (for rubber tracks) (number of teeth = 23) (number of holes = 9)		REF 143TA9705 (rubber) (230 x 109 x 37)
FAI 226				
REF 144TA7828 (for rubber tracks) (Ø flange = 115,00 mm) (Ø body = 85,00 mm)		REF 144TA7656 (for rubber tracks) (number of teeth = 23) (number of holes = 9)		REF 143TA9705 (rubber) (230 x 109 x 37)
FAI 230				
		REF 144TA7657 (for rubber tracks) (number of teeth = 23) (number of holes = 9)	REF 144TA7550 (front, with bracket assembly) (for rubber tracks) (Ø = 338,00 mm)	REF 143TA9706 (rubber) (300 x 109 x 39)
FAI 232				
REF 144TA7829 (for rubber tracks) (Ø flange = 115,00 mm) (Ø body = 85,00 mm)		REF 144TA7658 (for rubber tracks) (number of teeth = 23) (number of holes = 9)	REF 144TA7551 (front, with bracket assembly) (for rubber tracks) (Ø = 338,00 mm)	REF 143TA9707 (rubber) (300 x 109 x 40)
FAI 235				
REF 144TA7830 (for rubber tracks) (Ø flange = 145,00 mm) (Ø body = 85,00 mm)		REF 144TA7659 (for rubber tracks) (number of teeth = 23) (number of holes = 9)	REF 144TA7552 (front, with bracket assembly) (for rubber tracks) (Ø = 338,00 mm)	REF 143TA9708 (rubber) (300 x 109 x 41)
FAI 240				
		REF 144TA7660 (for rubber tracks) (number of teeth = 23) (number of holes = 9)	REF 144TA7553 (front, with bracket assembly) (for rubber tracks) (Ø = 338,00 mm)	REF 143TA9708 (rubber) (300 x 109 x 41)
FAI 245				
REF 144TA7831 (for rubber tracks) (Ø flange = 150,00 mm) (Ø body = 95,00 mm)	REF 144TA7737 (assembly) (for rubber tracks)		REF 144TA7555 (front, with bracket assembly) (for steel tracks) (Ø = 338,00 mm)	REF 143TA9709 (rubber) (400 x 142 x 37)
REF 144TA7832 (for steel tracks) (Ø flange = 150,00 mm) (Ø body = 95,00 mm)	REF 144TA7738 (assembly) (for steel tracks) (Ø body = 82,00 mm)		REF 144TA7554 (front, with bracket assembly) (for rubber tracks) (Ø = 338,00 mm)	
FAI 250				
REF 144TA7833 (for rubber tracks) (Ø flange = 150,00 mm) (Ø body = 95,00 mm)	REF 144TA7739 (assembly) (for rubber tracks)		REF 144TA7556 (front, with bracket assembly) (for rubber tracks) (Ø = 371,00 mm)	REF 164TA3062 (rubber) (230 x 72 x 43)
REF 144TA7834 (for steel tracks) (Ø flange = 150,00 mm) (Ø body = 95,00 mm)	REF 144TA7740 (assembly) (for steel tracks) (Ø body = 82,00 mm)		REF 144TA7557 (front, with bracket assembly) (for steel tracks) (Ø = 371,00 mm)	



USED FOR
FIAT HITACHI



used for FIAT HITACHI				
TRACK ROLLER	TOP ROLLER	SPROCKET	IDLER	TRACK
				
FIAT HITACHI EX135				
REF 164TA1521 (Ø flange = 166,00 mm) (Ø body = 137,00 mm)	REF 164TA1524 (assembly)	REF 164TA1525	REF 164TA1520 (front, with bracket assembly)	
FIAT HITACHI EX135UR				
<i>S/N: up to - 01583</i>				
REF 164TA1522 (for steel tracks)	REF 164TA1526 (assembly)	REF 163TA9221	REF 164TA2131 (front, with bracket assembly) (for steel tracks)	
<i>S/N: 01584 - and up</i>				
REF 164TA1522 (for steel tracks)	REF 164TA1526 (assembly)	REF 163TA9221	REF 164TA1523 (front, with bracket assembly) (for steel tracks)	
FIAT HITACHI EX75UR				
REF 163TA9222	REF 163TA9223 (assembly)	REF 163TA9220 (number of teeth = 21) (number of holes = 12)	REF 163TA9224 (front, with bracket assembly) (Ø = 429,00 mm)	
FIAT HITACHI FH15-2				
REF 144TA7835 (for rubber tracks) (inner guide) (Ø flange = 95,00 mm) (Ø body = 75,00 mm)		REF 144TA1909 (for rubber tracks) (number of teeth = 19) (number of holes = 9)	REF 144TA7558 (front, with bracket assembly) (for rubber tracks) (Ø = 249,00 mm)	REF 164TA3050 (rubber) (230 x 96 x 31)
FIAT HITACHI FH16-2				
REF 144TA7836 (for rubber tracks) (inner guide) (Ø flange = 95,00 mm) (Ø body = 75,00 mm)		REF 144TA7661 (for rubber tracks) (number of teeth = 19) (number of holes = 9)	REF 144TA7559 (front, with bracket assembly) (for rubber tracks) (Ø = 249,00 mm)	REF 143TA9944 (rubber) (230 x 96 x 33)
FIAT HITACHI FH22-2				
REF 144TA7837 (for rubber tracks) (Ø flange = 108,00 mm) (Ø body = 85,00 mm)				REF 164TA3022 (rubber) (250 x 52,5 x 73)
FIAT HITACHI FH30-2				
REF 144TA7838 (for rubber tracks) (Ø flange = 108,00 mm) (Ø body = 85,00 mm)	REF 144TA7741 (assembly) (for rubber tracks) (Ø body = 80,00 mm)	REF 144TA7662 (for rubber tracks) (number of teeth = 21) (number of holes = 11)	REF 144TA7560 (front, with bracket assembly) (for rubber tracks) (Ø = 307,00 mm)	REF 143TA9712 (rubber) (300 x 52,5 x 84)
FIAT HITACHI FH35-2				
REF 144TA7839 (for rubber tracks) (Ø flange = 108,00 mm) (Ø body = 85,00 mm)	REF 144TA7742 (assembly) (for rubber tracks) (Ø body = 80,00 mm)	REF 144TA7663 (for rubber tracks) (number of teeth = 21) (number of holes = 11)	REF 144TA7561 (front, with bracket assembly) (for rubber tracks) (Ø = 307,00 mm)	REF 143TA9712 (rubber) (300 x 52,5 x 84)
FIAT HITACHI FH40-2				
REF 144TA7840 (for rubber tracks) (Ø flange = 122,00 mm) (Ø body = 95,00 mm)	REF 144TA7743 (assembly) (for rubber tracks) (Ø body = 80,00 mm)			REF 164TA9684 (rubber) (400 x 72,5 x 72)
FIAT HITACHI FH45-2				
REF 144TA7841 (for rubber tracks) (Ø flange = 122,00 mm) (Ø body = 95,00 mm)	REF 144TA7744 (assembly) (for rubber tracks) (Ø body = 80,00 mm)	REF 144TA1805 (for rubber tracks) (number of teeth = 19) (number of holes = 9)		REF 164TA9684 (rubber) (400 x 72,5 x 72)
FIAT HITACHI FH95				
REF 164TA2099		REF 164TA2076	REF 164TA2130 (front, with bracket assembly)	



USED FOR
GEHL

TRACKS & UNDERCARRIAGE PARTS



used for GEHL

used for GEHL				
TRACK ROLLER	TOP ROLLER	SPROCKET	IDLER	TRACK
				
GEHL 1202				
<i>S/N: up to - AC03528</i>				
REF 164TA2350 (for rubber tracks) (Ø flange = 185,00 mm) (Ø body = 130,00 mm)	REF 164TA2356 (assembly) (for rubber and steel tracks)	REF 164TA2349 (for rubber tracks) (number of teeth = 20) (number of holes = 15)	REF 164TA2355 (front, with bracket assembly) (for rubber tracks)	REF 164TA2351 (rubber) (500 x 92w x 78)
REF 164TA2353 (for steel tracks) (Ø flange = 166,00 mm) (Ø body = 137,00 mm)		REF 164TA2352 (for steel tracks)	REF 164TA2354 (front, with bracket assembly) (for steel tracks)	
<i>S/N: AC03529 - and up</i>				
REF 164TA2350 (for rubber tracks) (Ø flange = 185,00 mm) (Ø body = 130,00 mm)	REF 164TA2400 (assembly) (for rubber and steel tracks)	REF 164TA2349 (for rubber tracks) (number of teeth = 20) (number of holes = 15)	REF 164TA2355 (front, with bracket assembly) (for rubber tracks)	REF 164TA2351 (rubber) (500 x 92w x 78)
REF 164TA2353 (for steel tracks) (Ø flange = 166,00 mm) (Ø body = 137,00 mm)		REF 164TA2352 (for steel tracks)	REF 164TA2354 (front, with bracket assembly) (for steel tracks)	
GEHL 142				
REF 164TA2328 (for rubber tracks) (Ø flange = 116,00 mm) (Ø body = 80,00 mm)	REF 164TA2347 (guide) (for rubber tracks) (plate type)	REF 164TA2329 (for rubber tracks) (number of teeth = 21) (number of holes = 9)	REF 164TA2333 (front, with bracket assembly) (for rubber tracks) (Ø = 236,00 mm)	REF 164TA2330 (rubber) (230 x 96 x 36)
GEHL 152				
REF 164TA2328 (for rubber tracks) (Ø flange = 116,00 mm) (Ø body = 80,00 mm)	REF 164TA2347 (guide) (for rubber tracks) (plate type)	REF 164TA2329 (for rubber tracks) (number of teeth = 21) (number of holes = 9)	REF 164TA2333 (front, with bracket assembly) (for rubber tracks) (Ø = 236,00 mm)	REF 164TA2330 (rubber) (230 x 96 x 36)
GEHL 153				
<i>S/N: up to - AD00453</i>				
REF 164TA2328 (for rubber tracks) (Ø flange = 116,00 mm) (Ø body = 80,00 mm)	REF 164TA2347 (guide) (for rubber tracks) (plate type)	REF 164TA2329 (for rubber tracks) (number of teeth = 21) (number of holes = 9)	REF 164TA2380 (front, with bracket assembly) (for rubber tracks) (Ø = 236,00 mm)	REF 164TA2331 (rubber) (230 x 96 x 36)
<i>For all other serial ranges applicable</i>				
REF 164TA2328 (for rubber tracks) (Ø flange = 116,00 mm) (Ø body = 80,00 mm)		REF 164TA2329 (for rubber tracks) (number of teeth = 21) (number of holes = 9)	REF 164TA2380 (front, with bracket assembly) (for rubber tracks) (Ø = 236,00 mm)	REF 164TA2331 (rubber) (230 x 96 x 36)
GEHL 192				
REF 164TA2328 (for rubber tracks) (Ø flange = 116,00 mm) (Ø body = 80,00 mm)	REF 164TA2347 (guide) (for rubber tracks) (plate type)	REF 164TA2332 (for rubber tracks) (number of teeth = 21) (number of holes = 9)	REF 164TA2333 (front, with bracket assembly) (for rubber tracks) (Ø = 236,00 mm)	REF 164TA2331 (rubber) (230 x 96 x 36)
GEHL 193				
REF 164TA2328 (for rubber tracks) (Ø flange = 116,00 mm) (Ø body = 80,00 mm)		REF 164TA2332 (for rubber tracks) (number of teeth = 21) (number of holes = 9)	REF 164TA2380 (front, with bracket assembly) (for rubber tracks) (Ø = 236,00 mm)	REF 164TA2381 (rubber) (260 x 96 x 38)
REF 164TA2369 (for steel tracks) (Ø flange = 100,00 mm) (Ø body = 80,00 mm)		REF 164TA2370 (for steel tracks) (number of teeth = 19) (number of holes = 9)	REF 164TA2368 (front, with bracket assembly) (for steel tracks) (Ø = 236,00 mm)	



used for GEHL				
TRACK ROLLER	TOP ROLLER	SPROCKET	IDLER	TRACK
				
GEHL 222				
REF 164TA2328 (for rubber tracks) (Ø flange = 116,00 mm) (Ø body = 80,00 mm)	REF 164TA2347 (guide) (for rubber tracks) (plate type)	REF 164TA2332 (for rubber tracks) (number of teeth = 21) (number of holes = 9)	REF 164TA2333 (front, with bracket assembly) (for rubber tracks) (Ø = 236,00 mm)	REF 164TA2331 (rubber) (230 x 96 x 36)
GEHL 223				
REF 164TA2328 (for rubber tracks) (Ø flange = 116,00 mm) (Ø body = 80,00 mm)		REF 164TA2332 (for rubber tracks) (number of teeth = 21) (number of holes = 9)	REF 164TA2380 (front, with bracket assembly) (for rubber tracks) (Ø = 236,00 mm)	REF 164TA2381 (rubber) (260 x 96 x 38)
REF 164TA2369 (for steel tracks) (Ø flange = 100,00 mm) (Ø body = 80,00 mm)		REF 164TA2370 (for steel tracks) (number of teeth = 19) (number of holes = 9)	REF 164TA2368 (front, with bracket assembly) (for steel tracks) (Ø = 236,00 mm)	
GEHL 253				
REF 164TA2359 (for rubber tracks) (Ø flange = 130,00 mm) (Ø body = 95,00 mm)	REF 164TA2360 (assembly) (for rubber tracks) (Ø flange = 104,00 mm) (Ø body = 80,00 mm)	REF 164TA2358 (for rubber tracks) (number of teeth = 23) (number of holes = 9)	REF 164TA2361 (front, with bracket assembly) (for rubber tracks) (Ø = 338,00 mm)	REF 164TA2357 (rubber) (250 x 109 x 37)
GEHL 272				
REF 164TA2336 (for rubber tracks) (Ø flange = 124,00 mm) (Ø body = 100,00 mm)	REF 164TA2348 (assembly) (for rubber tracks) (skid type)	REF 164TA2334 (for rubber tracks) (number of teeth = 21) (number of holes = 9)	REF 164TA2337 (front, with bracket assembly) (for rubber tracks) (Ø = 295,00 mm)	REF 164TA2335 (rubber) (300 x 52,5n x 74)
GEHL 283Z				
REF 164TA2392 (for rubber tracks) (Ø flange = 130,00 mm) (Ø body = 95,00 mm)	REF 164TA2360 (assembly) (for rubber tracks) (Ø flange = 104,00 mm) (Ø body = 80,00 mm)	REF 164TA2358 (for rubber tracks) (number of teeth = 23) (number of holes = 9)	REF 164TA2361 (front, with bracket assembly) (for rubber tracks) (Ø = 338,00 mm)	REF 164TA2391 (rubber) (300 x 52,5w x 82)
GEHL 292				
REF 164TA2336 (for rubber tracks) (Ø flange = 124,00 mm) (Ø body = 100,00 mm)	REF 164TA2348 (assembly) (for rubber tracks) (skid type)	REF 164TA2334 (for rubber tracks) (number of teeth = 21) (number of holes = 9)	REF 164TA2337 (front, with bracket assembly) (for rubber tracks) (Ø = 295,00 mm)	REF 164TA2335 (rubber) (300 x 52,5n x 74)
GEHL 303				
REF 164TA2392 (for rubber tracks) (Ø flange = 130,00 mm) (Ø body = 95,00 mm)	REF 164TA2360 (assembly) (for rubber and steel tracks) (Ø flange = 104,00 mm) (Ø body = 80,00 mm)	REF 164TA2358 (for rubber and steel tracks) (number of teeth = 23) (number of holes = 9)	REF 164TA2393 (front, with bracket assembly) (for rubber and steel tracks) (Ø = 338,00 mm)	REF 164TA2362 (rubber) (300 x 109w x 38)
REF 164TA2394 (for steel tracks) (Ø flange = 170,00 mm) (Ø body = 95,00 mm)				
GEHL 342				
REF 164TA2336 (for rubber tracks) (Ø flange = 124,00 mm) (Ø body = 100,00 mm)	REF 164TA2348 (guide) (for rubber tracks) (plate type)	REF 164TA2334 (for rubber tracks) (number of teeth = 21) (number of holes = 9)	REF 164TA2337 (front, with bracket assembly) (for rubber tracks) (Ø = 295,00 mm)	REF 164TA2338 (rubber) (320 x 54 x 78)
GEHL 353				
REF 164TA2392 (for rubber tracks) (Ø flange = 130,00 mm) (Ø body = 95,00 mm)	REF 164TA2360 (assembly) (for rubber and steel tracks) (Ø flange = 104,00 mm) (Ø body = 80,00 mm)	REF 164TA2363 (for rubber and steel tracks) (number of teeth = 23) (number of holes = 9)	REF 164TA2393 (front, with bracket assembly) (for rubber and steel tracks) (Ø = 338,00 mm)	REF 164TA2364 (rubber) (300 x 52,5w x 84)



used for GEHL

used for GEHL				
TRACK ROLLER	TOP ROLLER	SPROCKET	IDLER	TRACK
				
REF 164TA2394 (for steel tracks) (Ø flange = 170,00 mm) (Ø body = 95,00 mm)				
GEHL 362				
REF 164TA2336 (for rubber tracks) (Ø flange = 124,00 mm) (Ø body = 100,00 mm)	REF 164TA2348 (guide) (for rubber tracks) (plate type)	REF 164TA2334 (for rubber tracks) (number of teeth = 21) (number of holes = 9)	REF 164TA2337 (front, with bracket assembly) (for rubber tracks) (Ø = 295,00 mm)	REF 164TA2338 (rubber) (320 x 54 x 78)
GEHL 373				
REF 164TA2392 (for rubber tracks) (Ø flange = 130,00 mm) (Ø body = 95,00 mm)	REF 164TA2360 (assembly) (for rubber and steel tracks) (Ø flange = 104,00 mm) (Ø body = 80,00 mm)	REF 164TA2363 (for rubber and steel tracks) (number of teeth = 23) (number of holes = 9)	REF 164TA2393 (front, with bracket assembly) (for rubber and steel tracks) (Ø = 338,00 mm)	REF 164TA2364 (rubber) (300 x 52,5w x 84)
REF 164TA2394 (for steel tracks) (Ø flange = 170,00 mm) (Ø body = 95,00 mm)				
GEHL 383Z				
REF 164TA2392 (for rubber tracks) (Ø flange = 130,00 mm) (Ø body = 95,00 mm)	REF 164TA2360 (assembly) (for rubber tracks) (Ø flange = 104,00 mm) (Ø body = 80,00 mm)	REF 164TA2363 (for rubber tracks) (number of teeth = 23) (number of holes = 9)	REF 164TA2393 (front, with tensioner) (for rubber tracks) (Ø = 338,00 mm)	REF 164TA2364 (rubber) (300 x 52,5w x 84)
GEHL 502				
<i>S/N: up to - AB01587</i>				
REF 164TA2372 (for rubber and steel tracks) (Ø flange = 140,00 mm) (Ø body = 110,00 mm)	REF 164TA2339 (assembly) (for rubber and steel tracks) (Ø body = 105,00 mm)	REF 164TA2341 (for rubber and steel tracks) (number of teeth = 19) (number of holes = 9)	REF 164TA2371 (front, with bracket assembly) (for steel tracks) (Ø = 362,00 mm) REF 164TA2421 (front, with bracket assembly) (for rubber and steel tracks) (Ø = 362,00 mm)	REF 164TA2340 (rubber) (400 x 72,5w x 74)
<i>S/N: AB01588 - and up</i>				
REF 164TA2372 (for rubber and steel tracks) (Ø flange = 140,00 mm) (Ø body = 110,00 mm)	REF 164TA2339 (assembly) (for rubber and steel tracks) (Ø body = 105,00 mm)	REF 164TA2341 (for rubber and steel tracks) (number of teeth = 19) (number of holes = 9)	REF 164TA2373 (front, with bracket assembly) (for steel tracks) (Ø = 362,00 mm) REF 164TA2421 (front, with bracket assembly) (for rubber and steel tracks) (Ø = 362,00 mm)	REF 164TA2340 (rubber) (400 x 72,5w x 74)
GEHL 503Z				
<i>S/N: up to - AC03216</i>				
REF 164TA2372 (for rubber and steel tracks) (Ø flange = 140,00 mm) (Ø body = 110,00 mm)	REF 164TA2367 (assembly) (for rubber and steel tracks) (Ø body = 80,00 mm)	REF 164TA2341 (for rubber and steel tracks) (number of teeth = 19) (number of holes = 9)	REF 164TA2421 (front, with bracket assembly) (for rubber tracks) (Ø = 362,00 mm) REF 164TA2373 (front, with bracket assembly) (for steel tracks) (Ø = 362,00 mm)	REF 164TA2340 (rubber) (400 x 72,5w x 74)



used for GEHL				
TRACK ROLLER	TOP ROLLER	SPROCKET	IDLER	TRACK
				
<i>S/N: AC03217 - and up</i>				
REF 164TA2372 (for rubber and steel tracks) (Ø flange = 140,00 mm) (Ø body = 110,00 mm)	REF 164TA2367 (assembly) (for rubber and steel tracks) (Ø body = 80,00 mm)	REF 164TA2341 (for rubber and steel tracks) (number of teeth = 19) (number of holes = 9)	REF 164TA2401 (front, with bracket assembly) (for rubber tracks) (Ø = 362,00 mm) REF 164TA2373 (front, with bracket assembly) (for steel tracks) (Ø = 362,00 mm)	REF 164TA2340 (rubber) (400 x 72,5w x 74)
GEHL 602				
REF 164TA2372 (for rubber and steel tracks) (Ø flange = 140,00 mm) (Ø body = 110,00 mm)	REF 164TA2339 (assembly) (for rubber and steel tracks) (Ø body = 105,00 mm)	REF 164TA2341 (for rubber and steel tracks) (number of teeth = 19) (number of holes = 9)	REF 164TA2421 (front, with bracket assembly) (for rubber tracks) (Ø = 362,00 mm) REF 164TA2371 (front, with bracket assembly) (for steel tracks) (Ø = 362,00 mm)	REF 164TA2340 (rubber) (400 x 72,5w x 74)
GEHL 603				
<i>S/N: AC02513 - AC03712</i>				
REF 164TA2372 (for rubber and steel tracks) (Ø flange = 140,00 mm) (Ø body = 110,00 mm)	REF 164TA2395 (assembly) (for rubber and steel tracks) (Ø body = 80,00 mm)	REF 164TA2341 (for rubber and steel tracks) (number of teeth = 19) (number of holes = 9)	REF 164TA2396 (front, with bracket assembly) (for rubber tracks) (Ø = 362,00 mm) REF 164TA2373 (front, with bracket assembly) (for steel tracks) (Ø = 362,00 mm)	REF 164TA2398 (rubber) (400 x 72,5w x 74)
<i>S/N: AC03713 - and up</i>				
REF 164TA2372 (for rubber and steel tracks) (Ø flange = 140,00 mm) (Ø body = 110,00 mm)	REF 164TA2395 (assembly) (for rubber and steel tracks) (Ø body = 80,00 mm)	REF 164TA2341 (for rubber and steel tracks) (number of teeth = 19) (number of holes = 9)	REF 164TA2401 (front, with bracket assembly) (for rubber tracks) (Ø = 362,00 mm) REF 164TA2373 (front, with bracket assembly) (for steel tracks) (Ø = 362,00 mm)	REF 164TA2398 (rubber) (400 x 72,5w x 74)
GEHL 753Z				
<i>S/N: up to - AC02793</i>				
REF 164TA2344 (for rubber and steel tracks) (outer guide) (Ø flange = 155,00 mm) (Ø body = 121,00 mm) REF 164TA2345 (for rubber tracks) (inner guide) (Ø flange = 188,00 mm) (Ø body = 135,00 mm)	REF 164TA2346 (assembly) (for rubber and steel tracks) (Ø flange = 120,00 mm) (Ø body = 90,70 mm)	REF 164TA2399 (for rubber tracks) (number of teeth = 22) (number of holes = 12) REF 164TA2366 (for steel tracks) (number of teeth = 21) (number of holes = 12)	REF 164TA2375 (front, with bracket assembly) (for rubber tracks) REF 164TA2402 (front, with bracket assembly) (for steel tracks) (Ø = 410,00 mm)	REF 164TA2397 (rubber) (450 x 71 x 86)
<i>S/N: AC02794 - and up</i>				
REF 164TA2344 (for rubber and steel tracks) (outer guide) (Ø flange = 155,00 mm) (Ø body = 121,00 mm)	REF 164TA2346 (assembly) (for rubber and steel tracks) (Ø flange = 120,00 mm) (Ø body = 90,70 mm)	REF 164TA2365 (for rubber tracks) (number of teeth = 22) (number of holes = 12)	REF 164TA2375 (front, with bracket assembly) (for rubber tracks)	REF 164TA2397 (rubber) (450 x 71 x 86)



used for GEHL

used for GEHL				
TRACK ROLLER	TOP ROLLER	SPROCKET	IDLER	TRACK
				
REF 164TA2345 (for rubber tracks) (inner guide) (Ø flange = 188,00 mm) (Ø body = 135,00 mm)		REF 164TA2366 (for steel tracks) (number of teeth = 21) (number of holes = 12)	REF 164TA2402 (front, with bracket assembly) (for steel tracks) (Ø = 410,00 mm)	
GEHL 802				
REF 164TA2345 (for rubber tracks) (inner guide) (Ø flange = 188,00 mm) (Ø body = 135,00 mm)	REF 164TA2346 (assembly) (for rubber and steel tracks) (Ø flange = 120,00 mm) (Ø body = 90,70 mm)	REF 164TA2342 (for rubber tracks) (number of teeth = 23) (number of holes = 12)	REF 164TA2375 (front, with bracket assembly) (for rubber tracks)	REF 164TA2343 (rubber) (450 x 71 x 84)
REF 164TA2344 (for rubber and steel tracks) (outer guide) (Ø flange = 155,00 mm) (Ø body = 121,00 mm)		REF 164TA2374 (for steel tracks)	REF 164TA2376 (front, with bracket assembly) (for steel tracks)	
GEHL 803				
REF 164TA2344 (for rubber and steel tracks) (outer guide) (Ø flange = 155,00 mm) (Ø body = 121,00 mm)	REF 164TA2346 (assembly) (for rubber and steel tracks) (Ø flange = 120,00 mm) (Ø body = 90,70 mm)	REF 164TA2366 (for rubber and steel tracks) (number of teeth = 21) (number of holes = 12)	REF 164TA2375 (front, with bracket assembly) (for rubber tracks)	REF 164TA2403 (rubber) (450 x 76k x 80)
REF 164TA2345 (for rubber tracks) (inner guide) (Ø flange = 188,00 mm) (Ø body = 135,00 mm)			REF 164TA2402 (front, with bracket assembly) (for steel tracks) (Ø = 410,00 mm)	
GEHL CTL55				
REF 164TA2382 (for rubber tracks) (roller a)		REF 164TA2384 (for rubber tracks)	REF 164TA2383 (front, with bracket assembly) (for rubber tracks)	REF 164TA2386 (rubber) (320 x 86 x 46)
REF 164TA2385 (for rubber tracks) (roller b)				REF 164TA2389 (rubber) (special flat tread pattern)
GEHL CTL60				
REF 164TA2419 (for rubber tracks) (roller a) (Ø flange = 200,00 mm) (Ø body = 103,00 mm)		REF 164TA2417 (for rubber tracks) (number of teeth = 16) (number of holes = 9)	REF 164TA2420 (front, with bracket assembly) (for rubber tracks)	REF 164TA2377 (rubber) (320 x 86c x 52)
REF 164TA2418 (for rubber tracks) (roller b)				REF 164TA2379 (rubber) (450 x 86 x 52)
GEHL CTL65				
REF 164TA2418 (for rubber tracks) (roller b)		REF 164TA2417 (for rubber tracks) (number of teeth = 16) (number of holes = 9)	REF 164TA2420 (front, with bracket assembly) (for rubber tracks)	REF 164TA2379 (rubber) (450 x 86 x 52)
REF 164TA2419 (for rubber tracks) (roller a) (Ø flange = 200,00 mm) (Ø body = 103,00 mm)				REF 164TA2377 (rubber) (320 x 86c x 52)
GEHL CTL70				
<i>S/N: 21400011 - 21401390</i>				
REF 164TA2416 (for rubber tracks) (roller a) (Ø flange = 216,10 mm) (Ø body = 112,40 mm)		REF 164TA2411 (for rubber tracks) (number of teeth = 14) (number of holes = 9)	REF 164TA2414 (front, with bracket assembly) (for rubber tracks)	REF 164TA2378 (rubber) (450 x 100 x 48)
REF 164TA2415 (for rubber tracks) (roller b)				



used for GEHL				
TRACK ROLLER	TOP ROLLER	SPROCKET	IDLER	TRACK
				
<i>S/N: 21402001 - and up</i>				
REF 164TA2416 (for rubber tracks) (roller a) (Ø flange = 216,10 mm) (Ø body = 112,40 mm)		REF 164TA2413 (for rubber tracks) (number of teeth = 14) (number of holes = 9)	REF 164TA2414 (front, with bracket assembly) (for rubber tracks)	REF 164TA2378 (rubber) (450 x 100 x 48)
REF 164TA2415 (for rubber tracks) (roller b)				
GEHL CTL75				
REF 164TA2416 (for rubber tracks) (roller a) (Ø flange = 216,10 mm) (Ø body = 112,40 mm)		REF 164TA2413 (for rubber tracks) (number of teeth = 14) (number of holes = 9)	REF 164TA2414 (front, with bracket assembly) (for rubber tracks)	REF 164TA2378 (rubber) (450 x 100 x 48)
REF 164TA2415 (for rubber tracks) (roller b)				REF 164TA2387 (rubber) (special snow tread)
				REF 164TA2390 (rubber) (450 x 100 x 48)
GEHL CTL80				
REF 164TA2416 (for rubber tracks) (roller a) (Ø flange = 216,10 mm) (Ø body = 112,40 mm)		REF 164TA2413 (for rubber tracks) (number of teeth = 14) (number of holes = 9)	REF 164TA2414 (front, with bracket assembly) (for rubber tracks)	REF 164TA2412 (rubber) (450 x 100c x 50)
REF 164TA2415 (for rubber tracks) (roller b)				
GEHL CTL85				
REF 164TA2416 (for rubber tracks) (roller a) (Ø flange = 216,10 mm) (Ø body = 112,40 mm)		REF 164TA2413 (for rubber tracks) (number of teeth = 14) (number of holes = 9)	REF 164TA2420 (front, with bracket assembly) (for rubber tracks)	REF 164TA2412 (rubber) (450 x 100c x 50)
REF 164TA2415 (for rubber tracks) (roller b)				REF 164TA2388 (rubber) (special snow tread)
GEHL RT175				
REF 164TA2406 (for rubber tracks)		REF 164TA2404 (for rubber tracks)	REF 164TA2405 (front, with bracket assembly) (for rubber tracks)	REF 164TA2408 (rubber) (320 x 86c x 54)
			REF 164TA2409 (rear, with bracket assembly) (for rubber tracks)	
GEHL RT210				
REF 164TA2406 (for rubber tracks)		REF 164TA2404 (for rubber tracks)	REF 164TA2405 (front, with bracket assembly) (for rubber tracks)	REF 164TA2407 (rubber) (450 x 86 x 56)
			REF 164TA2409 (rear, with bracket assembly) (for rubber tracks)	
GEHL RT250				
REF 164TA2406 (for rubber tracks)		REF 164TA2404 (for rubber tracks)	REF 164TA2405 (front, with bracket assembly) (for rubber tracks)	REF 164TA2410 (rubber) (450 x 58 x 86)
			REF 164TA2409 (rear, with bracket assembly) (for rubber tracks)	



USED FOR
HANIX







used for HANIX				
TRACK ROLLER	TOP ROLLER	SPROCKET	IDLER	TRACK
				
HANIX H12A				
			REF 144TA7562 (front, with bracket assembly) (for rubber tracks)	REF 164TA3051 (rubber) (230 x 96 x 31)
HANIX H15A				
REF 144TA7846 (for rubber tracks) (Ø flange = 115,00 mm) (Ø body = 80,00 mm)	REF 144TA7746 (assembly) (for rubber tracks) (Ø flange = 115,00 mm) (Ø body = 80,00 mm)	REF 144TA7668 (for steel tracks) (number of teeth = 19) (number of holes = 9)	REF 144TA7564 (front, with bracket assembly) (for rubber tracks)	REF 164TA3043 (rubber) (230 x 96 x 33)
REF 144TA7847 (for rubber tracks) (Ø flange = 115,00 mm) (Ø body = 80,00 mm)	REF 144TA7747 (assembly) (for rubber tracks) (Ø flange = 115,00 mm) (Ø body = 80,00 mm)	REF 144TA7669 (for steel tracks) (number of teeth = 19) (number of holes = 9)	REF 144TA7565 (front, with bracket assembly) (for rubber tracks) (Ø = 263,00 mm)	REF 164TA3051 (rubber) (230 x 96 x 31)
REF 144TA7845 (for steel tracks) (Ø flange = 98,00 mm) (Ø body = 80,00 mm)	REF 144TA7745 (assembly) (for steel tracks) (Ø flange = 98,00 mm) (Ø body = 80,00 mm)	REF 144TA7667 (for steel tracks) (number of teeth = 19) (number of holes = 9)	REF 144TA7563 (front, with bracket assembly) (for steel tracks) (Ø = 263,00 mm)	
HANIX H15B				
			REF 144TA7566 (front, with bracket assembly) (for rubber tracks)	REF 164TA3051 (rubber) (230 x 96 x 31)
HANIX H15B-2				
		REF 143TA9082 (for rubber tracks) (number of teeth = 19) (number of holes = 8)	REF 144TA7567 (front, with bracket assembly) (for rubber tracks)	REF 164TA3043 (rubber) (230 x 96 x 33)
HANIX H15B-2Plus				
		REF 143TA9082 (for rubber tracks) (number of teeth = 19) (number of holes = 8)	REF 144TA7568 (front, with bracket assembly) (for rubber tracks)	REF 164TA3043 (rubber) (230 x 96 x 33)
HANIX H15B-Plus				
			REF 144TA7569 (front, with bracket assembly) (for rubber tracks)	REF 164TA3051 (rubber) (230 x 96 x 31)
HANIX H16D				
		REF 143TA9082 (for rubber tracks) (number of teeth = 19) (number of holes = 8)	REF 144TA7570 (front, with bracket assembly) (for rubber tracks)	REF 164TA3067 (rubber) (230 x 96 x 35)
HANIX H17D				
		REF 143TA9082 (for rubber tracks) (number of teeth = 19) (number of holes = 8)	REF 144TA7571 (front, with bracket assembly) (for rubber tracks)	REF 164TA3067 (rubber) (230 x 96 x 35)
HANIX H22B				
			REF 144TA7572 (front, with bracket assembly) (for rubber tracks)	REF 143TA9717 (rubber) (230 x 48 x 74)
HANIX H26B				
REF 144TA7848 (for rubber tracks) (Ø flange = 115,00 mm) (Ø body = 95,00 mm)	REF 144TA7748 (assembly) (for rubber tracks) (Ø body = 75,00 mm)			REF 143TA9718 (rubber) (300 x 52,5 x 74)



used for HANIX				
TRACK ROLLER	TOP ROLLER	SPROCKET	IDLER	TRACK
				
HANIX H36B				
REF 144TA7849 (for rubber tracks) (Ø flange = 115,00 mm) (Ø body = 95,00 mm)	REF 144TA7749 (assembly) (for rubber tracks) (Ø body = 75,00 mm)		REF 144TA7573 (front, with bracket assembly) (for rubber tracks) (Ø = 311,00 mm)	REF 164TA9673 (rubber) (300 x 55 x 80)
HANIX H36C				
REF 144TA7850 (for rubber tracks) (Ø flange = 133,00 mm) (Ø body = 95,00 mm)	REF 144TA7750 (assembly) (for rubber tracks) (Ø body = 75,00 mm)		REF 144TA7574 (front, with bracket assembly) (for rubber tracks) (Ø = 311,00 mm)	REF 164TA9673 (rubber) (300 x 55 x 80)
HANIX H45A				
REF 144TA7851 (for rubber tracks) (Ø flange = 118,80 mm) (Ø body = 100,30 mm)				REF 139TA9301 (rubber) (400 x 72,5 x 70)
HANIX H50B				
REF 144TA7852 (for rubber tracks) (Ø flange = 134,00 mm) (Ø body = 100,00 mm)				REF 164TA3029 (rubber) (400 x 72,5 x 72)
HANIX H50C				
REF 144TA7853 (for rubber tracks) (Ø flange = 134,00 mm) (Ø body = 100,00 mm)				REF 164TA3029 (rubber) (400 x 72,5 x 72)
HANIX H56C				
REF 144TA7854 (for rubber tracks) (Ø flange = 134,00 mm) (Ø body = 100,00 mm)				REF 164TA3029 (rubber) (400 x 72,5 x 72)
HANIX H75B				
REF 144TA7855 (for rubber tracks) (inner guide) (Ø flange = 149,00 mm) (Ø body = 125,00 mm)	REF 144TA7752 (assembly) (for rubber tracks)	REF 143TA9083 (for rubber and steel tracks)	REF 144TA7575 (front, with bracket assembly) (for rubber tracks)	REF 164TA6625 (rubber) (450 x 71 x 86)
REF 144TA7856 (for rubber tracks) (outer guide) (Ø flange = 158,00 mm) (Ø body = 132,00 mm)	REF 144TA7753 (assembly) (for steel tracks)		REF 144TA7576 (front, with bracket assembly) (for steel tracks)	
REF 144TA7857 (for steel tracks) (Ø flange = 158,00 mm) (Ø body = 132,00 mm)				
HANIX H75C				
REF 144TA7858 (for rubber tracks) (inner guide) (Ø flange = 149,00 mm) (Ø body = 125,00 mm)	REF 144TA7754 (assembly) (for rubber tracks)	REF 143TA9083 (for rubber tracks)	REF 144TA7577 (front, with bracket assembly) (for rubber tracks)	REF 164TA6625 (rubber) (450 x 71 x 86)
REF 144TA7859 (for rubber tracks) (outer guide) (Ø flange = 158,00 mm) (Ø body = 132,00 mm)				
HANIX N150				
			REF 144TA7579 (front, with bracket assembly) (for rubber tracks)	REF 164TA3063 (rubber) (230 x 72 x 43)
HANIX N350				
REF 144TA7871 (for rubber tracks) (Ø flange = 115,00 mm) (Ø body = 95,00 mm)		REF 144TA7671 (for rubber tracks) (number of teeth = 21) (number of holes = 12)		REF 143TA9719 (rubber) (320 x 100 x 43)



used for HANIX

used for HANIX				
TRACK ROLLER	TOP ROLLER	SPROCKET	IDLER	TRACK
				
HANIX N450				
			REF 144TA7580 (front, with bracket assembly) (for rubber tracks)	REF 143TA9720 (rubber) (420 x 100 x 52)
HANIX SB300				
REF 144TA7877 (for rubber tracks) (Ø flange = 133,00 mm) (Ø body = 95,00 mm)				REF 164TA9685 (rubber) (300 x 52,5 x 80)
REF 144TA7878 (for steel tracks) (Ø flange = 115,00 mm) (Ø body = 95,00 mm)				
HANIX SB800				
REF 144TA7879 (for rubber tracks)				REF 143TA9721 (rubber) (450 x 81 x 78)







USED FOR
HINOWA



used for HINOWA				
TRACK ROLLER	TOP ROLLER	SPROCKET	IDLER	TRACK
				
HINOWA DM 15				
REF 144TA7782 (for rubber tracks)		REF 144TA7620 (for rubber tracks)	REF 144TA7507 (wheel only) (for rubber tracks)	REF 143TA9758 (rubber) (230 x 72 x 43)
HINOWA DM 15 S				
		REF 144TA7621 (for rubber tracks) (number of teeth = 13) (number of holes = 8) (total height = 27,00 mm)		REF 143TA9758 (rubber) (230 x 72 x 43)
HINOWA DM 20				
REF 144TA7783 (for rubber tracks)		REF 144TA7622 (for rubber tracks)	REF 144TA7508 (wheel only) (for rubber tracks)	REF 143TA9722 (rubber) (250 x 72 x 52)
HINOWA DM 35				
REF 144TA7784 (for rubber tracks)				
HINOWA GOLDLIFT 14-70				
REF 144TA7844 (for rubber tracks) (Ø flange = 134,00 mm) (Ø body = 60,00 mm)				REF 143TA9723 (rubber) (180 x 72 x 37) (with rail)
HINOWA HP 1000				
REF 144TA7861 (for rubber tracks) (Ø flange = 134,00 mm) (Ø body = 60,00 mm)				REF 143TA9724 (rubber) (180 x 72 x 34)
HINOWA HP 1100				
REF 144TA7862 (for rubber tracks) (Ø flange = 134,00 mm) (Ø body = 60,00 mm)				REF 143TA9725 (rubber) (180 x 72 x 37)
HINOWA HP 1150				
REF 144TA7863 (for rubber tracks) (Ø flange = 134,00 mm) (Ø body = 60,00 mm)				REF 143TA9725 (rubber) (180 x 72 x 37)
HINOWA HP 1200				
REF 144TA7864 (for rubber tracks) (Ø flange = 134,00 mm) (Ø body = 60,00 mm)				REF 143TA9725 (rubber) (180 x 72 x 37)
HINOWA HP 1500				
			REF 144TA7578 (wheel only) (for rubber tracks)	REF 143TA9758 (rubber) (230 x 72 x 43)
HINOWA HP 850				
REF 144TA7865 (for rubber tracks) (Ø flange = 134,00 mm) (Ø body = 60,00 mm)		REF 144TA7670 (for rubber tracks) (number of teeth = 11) (number of holes = 8) (total height = 21,00 mm)		REF 143TA9726 (rubber) (180 x 72 x 35)
HINOWA HS 1100				
REF 144TA7866 (for rubber tracks) (Ø flange = 134,00 mm) (Ø body = 60,00 mm)				REF 143TA9725 (rubber) (180 x 72 x 37)
HINOWA LIGHTLIFT 14.72				
REF 144TA7868 (for rubber tracks) (Ø flange = 134,00 mm) (Ø body = 60,00 mm)				REF 143TA9725 (rubber) (180 x 72 x 37)
HINOWA LIGHTLIFT 19.65				
REF 144TA7869 (for rubber tracks) (Ø flange = 134,00 mm) (Ø body = 60,00 mm)				REF 143TA9725 (rubber) (180 x 72 x 37)



used for HINOWA				
TRACK ROLLER	TOP ROLLER	SPROCKET	IDLER	TRACK
				
HINOWA PT 70			REF 144TA7581 (wheel only) (for rubber tracks) ($\emptyset = 376,50$ mm)	REF 164TA9690 (rubber) (400 x 72,5 x 72)
HINOWA PT 9				
REF 144TA7872 (for rubber tracks) (\emptyset flange = 134,00 mm) (\emptyset body = 60,00 mm)				REF 143TA9725 (rubber) (180 x 72 x 37)
HINOWA VT 1650				
REF 144TA7892 (for rubber tracks) (new type) (\emptyset flange = 115,00 mm) (\emptyset body = 80,00 mm)	REF 144TA7763 (assembly) (for rubber tracks) (new type) (\emptyset flange = 115,00 mm) (\emptyset body = 80,00 mm)		REF 144TA7601 (wheel only) (for rubber tracks) (old type)	REF 143TA9727 (rubber) (230 x 96 x 32)
REF 144TA7893 (for rubber tracks) (old type)				
HINOWA VT 1650-2V				
REF 144TA7891 (for rubber tracks)			REF 144TA7600 (wheel only) (for rubber tracks)	REF 143TA9727 (rubber) (230 x 96 x 32)
HINOWA VT 3000				
		REF 144TA7685 (for rubber tracks) (number of teeth = 23) (number of holes = 9) (total height = 27,00 mm)		REF 143TA9728 (rubber) (300 x 52,5 x 76)
HINOWA VT 3000-2V				
		REF 144TA7686 (for rubber tracks)		REF 143TA9625 (rubber) (300 x 52,5 x 80)
HINOWA VT 4000				
REF 144TA7894 (for rubber tracks) (\emptyset flange = 119,00 mm) (\emptyset body = 95,00 mm)				REF 143TA9729 (rubber) (350 x 52,5 x 88)







USED FOR
HITACHI



used for HITACHI				
TRACK ROLLER	TOP ROLLER	SPROCKET	IDLER	TRACK
				
HITACHI EX100-2				
REF 163TA8975 (Ø flange = 166,00 mm) (Ø body = 137,00 mm)	REF 163TA8989 (assembly) (Ø flange = 118,00 mm) (Ø body = 100,00 mm)	REF 163TA8954 (number of teeth = 21) (number of holes = 16)	REF 163TA9011 (front, with bracket assembly)	
HITACHI EX100-3				
REF 163TA8976	REF 163TA8989 (assembly) (Ø flange = 118,00 mm) (Ø body = 100,00 mm)	REF 163TA8954 (number of teeth = 21) (number of holes = 16)	REF 163TA9012 (front, with bracket assembly) (Ø = 490,00 mm)	
HITACHI EX12				
REF 163TA8977		REF 144TA1899 (number of teeth = 19) (number of holes = 9)	REF 163TA9013 (front, with bracket assembly)	REF 143TA9730 (rubber) (230 x 96 x 31) (option)
HITACHI EX12-1				
			REF 144TA7513 (front, with bracket assembly) (for rubber tracks) (Ø = 249,00 mm)	REF 143TA9730 (rubber) (230 x 96 x 31)
HITACHI EX12-2				
REF 163TA8978 (Ø flange = 95,00 mm) (Ø body = 75,00 mm)		REF 163TA8955 (number of teeth = 19) (number of holes = 9)	REF 163TA9014 (front, with bracket assembly) (Ø = 249,00 mm)	REF 143TA9730 (rubber) (230 x 96 x 31)
HITACHI EX15				
REF 163TA8977		REF 144TA7627 (number of teeth = 19) (number of holes = 9)	REF 163TA9013 (front, with bracket assembly)	REF 143TA9730 (rubber) (230 x 96 x 31)
HITACHI EX15-1				
			REF 144TA7515 (front, with bracket assembly) (for rubber tracks) (Ø = 249,00 mm)	REF 143TA9730 (rubber) (230 x 96 x 31)
HITACHI EX15-2				
REF 163TA8978 (Ø flange = 95,00 mm) (Ø body = 75,00 mm)		REF 163TA8955 (number of teeth = 19) (number of holes = 9)	REF 163TA9014 (front, with bracket assembly) (Ø = 249,00 mm)	REF 143TA9730 (rubber) (230 x 96 x 31)
HITACHI EX16				
REF 144TA7791 (for rubber tracks) (inner guide) (Ø flange = 95,00 mm) (Ø body = 75,00 mm)				REF 164TA3042 (rubber) (230 x 96 x 33)
HITACHI EX16-2				
REF 144TA7791 (for rubber tracks) (inner guide) (Ø flange = 95,00 mm) (Ø body = 75,00 mm)				REF 164TA3042 (rubber) (230 x 96 x 33)
HITACHI EX16-3				
REF 144TA7791 (for rubber tracks) (inner guide) (Ø flange = 95,00 mm) (Ø body = 75,00 mm)				REF 164TA3042 (rubber) (230 x 96 x 33)
HITACHI EX17				
REF 144TA7792 (for rubber tracks) (inner guide) (Ø flange = 95,00 mm) (Ø body = 75,00 mm)		REF 144TA7628 (for rubber tracks) (number of teeth = 19) (number of holes = 9)		REF 164TA3042 (rubber) (230 x 96 x 33)



used for HITACHI				
TRACK ROLLER	TOP ROLLER	SPROCKET	IDLER	TRACK
				
HITACHI EX17-2				
			REF 144TA7517 (front, with bracket assembly) (for rubber tracks) (Ø = 249,00 mm)	REF 164TA3042 (rubber) (230 x 96 x 33)
HITACHI EX17-2B				
REF 163TA8974		REF 163TA8952 (number of teeth = 19) (number of holes = 9)	REF 163TA9007 (front, with bracket assembly)	REF 164TA3042 (rubber) (230 x 96 x 33)
HITACHI EX17U				
REF 144TA7794 (Ø flange = 95,00 mm) (Ø body = 75,00 mm)		REF 144TA7629 (number of teeth = 19) (number of holes = 9)	REF 144TA7518 (front, with bracket assembly) (for rubber tracks) (Ø = 249,00 mm) REF 163TA9008 (front, with bracket assembly) (for rubber tracks) REF 144TA7519 (front, with bracket assembly) (for steel tracks) (Ø = 249,00 mm)	REF 163TA8925 (rubber) (230 x 96 x 35)
HITACHI EX18				
REF 144TA1772 (for rubber tracks) (Ø flange = 108,00 mm) (Ø body = 85,00 mm)				
HITACHI EX18-2				
REF 144TA1772 (Ø flange = 108,00 mm) (Ø body = 85,00 mm)		REF 144TA7630 (for rubber tracks) (number of teeth = 21) (number of holes = 11)	REF 163TA9009 (front, with bracket assembly) (Ø = 307,00 mm)	REF 163TA8926 (rubber) (250 x 52,5 x 73)
HITACHI EX20-1				
REF 144TA1772 (for rubber tracks) (Ø flange = 108,00 mm) (Ø body = 85,00 mm)				
HITACHI EX20-2				
REF 144TA1772 (for rubber tracks) (Ø flange = 108,00 mm) (Ø body = 85,00 mm)				
HITACHI EX20UR				
REF 144TA7796 (Ø flange = 108,00 mm) (Ø body = 85,00 mm)		REF 163TA8953 (number of teeth = 21) (number of holes = 11)	REF 163TA9010 (front, with bracket assembly)	REF 163TA8927 (rubber) (250 x 52,5 x 76)
HITACHI EX22				
<i>S/N: up to - 00275</i>				
REF 163TA8979 (Ø flange = 108,00 mm) (Ø body = 85,00 mm)		REF 144TA7632 (number of teeth = 21) (number of holes = 11)	REF 163TA9010 (front, with bracket assembly)	REF 163TA8926 (rubber) (250 x 52,5 x 73)
REF 144TA7797 (for rubber tracks) (2nd type) (Ø flange = 108,00 mm) (Ø body = 85,00 mm)				
<i>S/N: 00726 - and up</i>				
REF 163TA8980		REF 144TA7632 (number of teeth = 21) (number of holes = 11)	REF 163TA9010 (front, with bracket assembly)	REF 163TA8926 (rubber) (250 x 52,5 x 73)

TRACKS & UNDERCARRIAGE PARTS



used for HITACHI

used for HITACHI				
TRACK ROLLER	TOP ROLLER	SPROCKET	IDLER	TRACK
				
REF 144TA7797 (for rubber tracks) (2nd type) (Ø flange = 108,00 mm) (Ø body = 85,00 mm)				
HITACHI EX22-1				
REF 144TA7797 (for rubber tracks) (Ø flange = 108,00 mm) (Ø body = 85,00 mm)				REF 163TA8926 (rubber) (250 x 52,5 x 73)
HITACHI EX22-2				
<i>S/N: up to - 00275</i>				
REF 144TA1772 (Ø flange = 108,00 mm) (Ø body = 85,00 mm)		REF 163TA8956 (number of teeth = 21) (number of holes = 11)	REF 163TA9009 (front, with bracket assembly) (Ø = 307,00 mm)	REF 163TA8926 (rubber) (250 x 52,5 x 73)
<i>For all other serial ranges applicable</i>				
		REF 163TA8956 (number of teeth = 21) (number of holes = 11)	REF 163TA9009 (front, with bracket assembly) (Ø = 307,00 mm)	REF 163TA8926 (rubber) (250 x 52,5 x 73)
HITACHI EX25				
REF 163TA8980	REF 144TA7703 (assembly) (for rubber tracks) (Ø body = 80,00 mm)	REF 144TA7633 (number of teeth = 21) (number of holes = 11)	REF 163TA9010 (front, with bracket assembly)	REF 163TA8928 (rubber) (300 x 52,5 x 76)
HITACHI EX27U				
REF 144TA7799 (Ø flange = 108,00 mm) (Ø body = 85,00 mm)	REF 144TA7704 (assembly) (Ø body = 80,00 mm)	REF 163TA8958	REF 163TA9017 (front, with bracket assembly) (Ø = 307,00 mm)	REF 163TA8930 (rubber) (300 x 52,5 x 78)
HITACHI EX29U				
REF 144TA7800 (for rubber tracks) (Ø flange = 108,00 mm) (Ø body = 85,00 mm)	REF 144TA7705 (assembly) (for rubber tracks) (Ø body = 80,00 mm)	REF 144TA7635 (for rubber tracks) (number of teeth = 21) (number of holes = 11)	REF 144TA7524 (front, with bracket assembly) (for rubber tracks) (Ø = 311,00 mm)	REF 143TA9733 (rubber) (300 x 52,5 x 78)
HITACHI EX30				
<i>S/N: up to - 00721</i>				
REF 164TA2100 (for steel tracks)	REF 163TA8991 (assembly) (for steel tracks) (Ø body = 84,00 mm)	REF 144TA7636 (for steel tracks) (number of teeth = 21) (number of holes = 11)	REF 163TA9018 (front, with bracket assembly) (for steel tracks)	REF 143TA9734 (rubber) (300 x 55 x 80)
<i>S/N: 00722 - and up</i>				
REF 163TA8980 (for steel tracks)	REF 163TA8991 (assembly) (for steel tracks) (Ø body = 84,00 mm)	REF 144TA7636 (for steel tracks) (number of teeth = 21) (number of holes = 11)	REF 163TA9018 (front, with bracket assembly) (for steel tracks)	REF 143TA9734 (rubber) (300 x 55 x 80)
HITACHI EX30-1				
REF 144TA1772 (for rubber tracks) (Ø flange = 108,00 mm) (Ø body = 85,00 mm)	REF 144TA7706 (assembly) (for rubber tracks) (Ø body = 80,00 mm)		REF 144TA7525 (front, with bracket assembly) (for rubber tracks) (Ø = 307,00 mm)	REF 143TA9734 (rubber) (300 x 55 x 80)
HITACHI EX30-2				
<i>S/N: up to - 03502</i>				
REF 144TA1772 (Ø flange = 108,00 mm) (Ø body = 85,00 mm)	REF 163TA8991 (assembly) (Ø body = 84,00 mm)		REF 144TA7526 (front, with bracket assembly) (Ø = 307,00 mm)	REF 163TA8931 (rubber) (300 x 52,5 x 82)
<i>S/N: up to - 05228</i>				
REF 144TA1772 (Ø flange = 108,00 mm) (Ø body = 85,00 mm)	REF 163TA8991 (assembly) (Ø body = 84,00 mm)	REF 163TA8959 (number of teeth = 21) (number of holes = 11)		REF 163TA8931 (rubber) (300 x 52,5 x 82)



used for HITACHI				
TRACK ROLLER	TOP ROLLER	SPROCKET	IDLER	TRACK
				
<i>S/N: 03503 - and up</i>				
REF 144TA1772 (∅ flange = 108,00 mm) (∅ body = 85,00 mm)	REF 163TA8991 (assembly) (∅ body = 84,00 mm)		REF 163TA9019 (front, with bracket assembly) (∅ = 307,00 mm)	REF 163TA8931 (rubber) (300 x 52,5 x 82)
<i>S/N: 05229 - and up</i>				
REF 144TA1772 (∅ flange = 108,00 mm) (∅ body = 85,00 mm)	REF 163TA8991 (assembly) (∅ body = 84,00 mm)	REF 163TA8956 (number of teeth = 21) (number of holes = 11)		REF 163TA8931 (rubber) (300 x 52,5 x 82)
HITACHI EX30U				
REF 144TA7802 (∅ flange = 108,00 mm) (∅ body = 85,00 mm)	REF 144TA7707 (assembly) (∅ body = 80,00 mm)	REF 144TA7637 (number of teeth = 21) (number of holes = 11)	REF 144TA7527 (front, with bracket assembly) (∅ = 307,00 mm)	REF 163TA8932 (rubber) (300 x 52,5 x 82)
HITACHI EX30UR-1				
REF 144TA7803 (for rubber tracks) (∅ flange = 108,00 mm) (∅ body = 85,00 mm)				REF 143TA9734 (rubber) (300 x 55 x 80)
HITACHI EX30UR-2				
REF 144TA7804 (∅ flange = 108,00 mm) (∅ body = 85,00 mm)		REF 163TA8953 (number of teeth = 21) (number of holes = 11)	REF 163TA9020 (front, with bracket assembly)	REF 163TA8933 (rubber) (300 x 52,5 x 76)
HITACHI EX30UR-3				
REF 144TA1772 (∅ flange = 108,00 mm) (∅ body = 85,00 mm)	REF 163TA8990 (assembly) (∅ body = 84,00 mm)	REF 163TA8959 (number of teeth = 21) (number of holes = 11)	REF 144TA7528 (front, with bracket assembly) (∅ = 307,00 mm)	REF 163TA8932 (rubber) (300 x 52,5 x 82)
HITACHI EX33				
REF 144TA7805 (for rubber tracks) (∅ flange = 108,00 mm) (∅ body = 85,00 mm)	REF 144TA7708 (assembly) (for rubber tracks) (∅ body = 80,00 mm)	REF 144TA7638 (for rubber tracks) (number of teeth = 21) (number of holes = 11)		REF 164TA3061 (rubber) (300 x 109 x 41)
HITACHI EX33MU				
REF 144TA7806 (∅ flange = 108,00 mm) (∅ body = 85,00 mm)	REF 144TA7709 (assembly) (∅ body = 80,00 mm)	REF 144TA7639 (number of teeth = 21) (number of holes = 11)	REF 163TA9021 (front, with bracket assembly)	REF 163TA8931 (rubber) (300 x 52,5 x 82)
HITACHI EX33U				
REF 144TA7807 (∅ flange = 108,00 mm) (∅ body = 85,00 mm)	REF 144TA7710 (assembly) (∅ body = 80,00 mm)	REF 144TA7640 (number of teeth = 21) (number of holes = 11)	REF 163TA9021 (front, with bracket assembly)	REF 164TA3061 (rubber) (300 x 109 x 41)
HITACHI EX35				
REF 163TA8980	REF 163TA8991 (assembly) (∅ body = 84,00 mm)	REF 163TA8960 (number of teeth = 21) (number of holes = 11)	REF 163TA9022 (front, with bracket assembly)	REF 163TA8934 (rubber) (300 x 52,5 x 86)
HITACHI EX35-1				
REF 144TA7808 (for rubber tracks) (∅ flange = 108,00 mm) (∅ body = 85,00 mm)		REF 144TA7641 (for rubber tracks) (number of teeth = 21) (number of holes = 11)	REF 144TA7529 (front, with bracket assembly) (for rubber tracks) (∅ = 307,00 mm)	REF 143TA9735 (rubber) (300 x 52,5 x 82)
HITACHI EX35-2				
<i>S/N: 02001 - 02984</i>				
REF 144TA1772 (∅ flange = 108,00 mm) (∅ body = 85,00 mm)	REF 163TA8992 (assembly)	REF 163TA8959 (number of teeth = 21) (number of holes = 11)	REF 163TA9016 (front, with bracket assembly) (∅ = 307,00 mm)	REF 143TA9735 (rubber) (300 x 52,5 x 86)

TRACKS & UNDERCARRIAGE PARTS



used for HITACHI

used for HITACHI				
TRACK ROLLER	TOP ROLLER	SPROCKET	IDLER	TRACK
				
<i>S/N: 02985 - and up</i>				
REF 144TA1772 (Ø flange = 108,00 mm) (Ø body = 85,00 mm)	REF 163TA8993 (assembly) (Ø body = 84,00 mm)	REF 163TA8959 (number of teeth = 21) (number of holes = 11)	REF 163TA9016 (front, with bracket assembly) (Ø = 307,00 mm)	REF 143TA9735 (rubber) (300 x 52,5 x 86)
HITACHI EX40				
<i>S/N: up to - 01064</i>				
REF 163TA8981 (Ø flange = 120,00 mm) (Ø body = 95,00 mm)	REF 163TA8994 (assembly)	REF 163TA8961	REF 163TA9023 (front, with bracket assembly)	REF 143TA9736 (rubber) (400 x 72,5 x 72)
<i>S/N: 01065 - and up</i>				
REF 163TA8981 (Ø flange = 120,00 mm) (Ø body = 95,00 mm)	REF 163TA8994 (assembly)	REF 144TA7642 (number of teeth = 19) (number of holes = 9)	REF 163TA9024 (front, with bracket assembly)	REF 143TA9736 (rubber) (400 x 72,5 x 72)
HITACHI EX40-1				
REF 144TA1911 (for rubber tracks) (Ø flange = 120,00 mm) (Ø body = 65,00 mm)	REF 144TA7712 (assembly) (for rubber tracks) (Ø body = 80,00 mm)		REF 144TA7530 (front, with bracket assembly) (for rubber tracks) (Ø = 358,00 mm)	REF 143TA9736 (rubber) (400 x 72,5 x 72)
HITACHI EX40-2				
<i>S/N: up to - 01064</i>				
REF 144TA1911 (Ø flange = 120,00 mm) (Ø body = 65,00 mm)	REF 144TA7713 (assembly) (Ø body = 80,00 mm)	REF 163TA8962 (number of teeth = 19) (number of holes = 9)	REF 144TA7531 (front, with bracket assembly) (Ø = 358,00 mm)	REF 143TA9736 (rubber) (400 x 72,5 x 72)
<i>For all other serial ranges applicable</i>				
REF 144TA1911 (Ø flange = 120,00 mm) (Ø body = 65,00 mm)	REF 144TA7713 (assembly) (Ø body = 80,00 mm)		REF 144TA7531 (front, with bracket assembly) (Ø = 358,00 mm)	REF 143TA9736 (rubber) (400 x 72,5 x 72)
HITACHI EX40U				
<i>S/P: 1B6</i>				
REF 144TA7810 (Ø flange = 120,00 mm) (Ø body = 95,00 mm)	REF 144TA7714 (assembly) (Ø body = 80,00 mm)	REF 163TA8963 (number of teeth = 18) (number of holes = 12)	REF 143TA9347 (front, with bracket assembly) (Ø = 360,00 mm)	REF 143TA9736 (rubber) (400 x 72,5 x 72)
HITACHI EX40UR				
REF 163TA8980	REF 163TA8991 (assembly) (Ø body = 84,00 mm)	REF 163TA8960 (number of teeth = 21) (number of holes = 11)	REF 163TA9022 (front, with bracket assembly)	REF 143TA9736 (rubber) (400 x 72,5 x 72)
REF 144TA1772 (for rubber tracks) (Ø flange = 108,00 mm) (Ø body = 85,00 mm)			REF 163TA9025 (front, with bracket assembly)	
HITACHI EX40UR-1				
REF 144TA1772 (for rubber tracks) (Ø flange = 108,00 mm) (Ø body = 85,00 mm)		REF 144TA7643 (for rubber tracks) (number of teeth = 21) (number of holes = 11)		REF 143TA9736 (rubber) (400 x 72,5 x 72)
HITACHI EX40UR-2				
REF 163TA8980	REF 163TA8995 (assembly)	REF 163TA8960 (number of teeth = 21) (number of holes = 11)	REF 163TA9026 (front, with bracket assembly)	REF 143TA9736 (rubber) (400 x 72,5 x 72)
REF 144TA1772 (Ø flange = 108,00 mm) (Ø body = 85,00 mm)	REF 163TA8996 (assembly)			
HITACHI EX40UR-3				
REF 144TA1772 (Ø flange = 108,00 mm) (Ø body = 85,00 mm)	REF 163TA8990 (assembly) (Ø body = 84,00 mm)	REF 144TA7643 (number of teeth = 21) (number of holes = 11)	REF 163TA9016 (front, with bracket assembly) (Ø = 307,00 mm)	REF 143TA9736 (rubber) (400 x 72,5 x 72)

TRACKS & UNDERCARRIAGE PARTS



used for HITACHI

used for HITACHI				
TRACK ROLLER	TOP ROLLER	SPROCKET	IDLER	TRACK
				
HITACHI EX45				
REF 163TA8981 (Ø flange = 120,00 mm) (Ø body = 95,00 mm)	REF 163TA8994 (assembly)	REF 144TA7644 (number of teeth = 19) (number of holes = 9)	REF 163TA9024 (front, with bracket assembly)	REF 143TA9736 (rubber) (400 x 72,5 x 72)
HITACHI EX45-1				
REF 144TA1911 (for rubber tracks) (Ø flange = 120,00 mm) (Ø body = 65,00 mm)	REF 144TA7715 (assembly) (for rubber tracks) (Ø body = 80,00 mm)			REF 143TA9736 (rubber) (400 x 72,5 x 72)
HITACHI EX45-2				
REF 144TA1911 (Ø flange = 120,00 mm) (Ø body = 65,00 mm)	REF 144TA7716 (assembly) (Ø body = 80,00 mm)	REF 163TA8962 (number of teeth = 19) (number of holes = 9)	REF 163TA9027 (front, with bracket assembly) (Ø = 348,00 mm)	REF 143TA9736 (rubber) (400 x 72,5 x 72)
HITACHI EX50U				
REF 144TA7812 (Ø flange = 120,00 mm) (Ø body = 95,00 mm)	REF 144TA7717 (assembly) (Ø body = 80,00 mm)	REF 163TA8963 (number of teeth = 18) (number of holes = 12)	REF 143TA9347 (front, with bracket assembly) (Ø = 360,00 mm)	REF 143TA9736 (rubber) (400 x 72,5 x 72)
HITACHI EX50UR				
REF 163TA8982		REF 144TA7645 (number of teeth = 19) (number of holes = 9)	REF 143TA9348 (front, with bracket assembly)	REF 143TA9736 (rubber) (400 x 72,5 x 72)
HITACHI EX50UR-2				
REF 144TA1911 (for rubber tracks) (Ø flange = 120,00 mm) (Ø body = 65,00 mm)			REF 143TA9348 (front, with bracket assembly) (for rubber tracks)	REF 143TA9736 (rubber) (400 x 72,5 x 72)
HITACHI EX50URG				
REF 163TA8982		REF 144TA7645 (number of teeth = 19) (number of holes = 9)	REF 143TA9348 (front, with bracket assembly)	REF 143TA9736 (rubber) (400 x 72,5 x 72)
HITACHI EX55UR				
<i>S/N: 00101 - 02708</i>				
REF 144TA7815 (Ø flange = 120,00 mm) (Ø body = 95,00 mm)	REF 144TA7718 (assembly) (Ø body = 80,00 mm)	REF 144TA7647 (number of teeth = 19) (number of holes = 9)	REF 143TA9349 (front, with bracket assembly)	REF 164TA9686 (rubber) (400 x 72,5 x 76)
<i>S/N: 02709 - and up</i>				
REF 144TA7815 (Ø flange = 120,00 mm) (Ø body = 95,00 mm)	REF 163TA8997 (assembly) (Ø body = 84,00 mm)	REF 144TA7647 (number of teeth = 19) (number of holes = 9)	REF 143TA9349 (front, with bracket assembly)	REF 164TA9686 (rubber) (400 x 72,5 x 76)
HITACHI EX55UR-3				
REF 144TA7816 (Ø flange = 120,00 mm) (Ø body = 95,00 mm)	REF 144TA7719 (assembly) (for rubber tracks) (Ø body = 80,00 mm)	REF 163TA8962 (number of teeth = 19) (number of holes = 9)	REF 143TA9349 (front, with bracket assembly)	REF 163TA8935 (rubber) (400 x 72,5 x 72)
HITACHI EX58				
REF 144TA7817 (for steel tracks) (Ø flange = 120,00 mm) (Ø body = 95,00 mm)		REF 144TA7648 (for steel tracks) (number of teeth = 19) (number of holes = 9)		
HITACHI EX58MU				
REF 144TA7818 (Ø flange = 120,00 mm) (Ø body = 95,00 mm)	REF 163TA8997 (assembly) (Ø body = 84,00 mm)	REF 144TA7649 (number of teeth = 19) (number of holes = 9)	REF 143TA9349 (front, with bracket assembly)	REF 164TA3015 (rubber) (400 x 72,5 x 74)

TRACKS & UNDERCARRIAGE PARTS



used for HITACHI

used for HITACHI				
TRACK ROLLER	TOP ROLLER	SPROCKET	IDLER	TRACK
				
HITACHI EX60				
<i>S/N: up to - 20462</i>				
REF 163TA8983 (Ø flange = 145,00 mm) (Ø body = 120,00 mm)	REF 163TA8998 (assembly) (Ø flange = 100,00 mm) (Ø body = 86,00 mm)	REF 144TA7650 (for rubber tracks) (number of teeth = 21) (number of holes = 12)	REF 163TA9028 (front, with bracket assembly) (Ø = 429,00 mm)	REF 143TA9738 (rubber) (450 x 81 x 72)
<i>S/N: 20463 - and up</i>				
REF 163TA8983 (Ø flange = 145,00 mm) (Ø body = 120,00 mm)	REF 163TA8999 (assembly)	REF 144TA7650 (for rubber tracks) (number of teeth = 21) (number of holes = 12)	REF 163TA9028 (front, with bracket assembly) (Ø = 429,00 mm)	REF 143TA9738 (rubber) (450 x 81 x 72)
HITACHI EX60-2				
<i>S/N: up to - 33180</i>				
REF 144TA8698 (Ø flange = 132,00 mm) (Ø body = 110,00 mm)	REF 163TA8999 (assembly)	REF 163TA8964 (number of teeth = 21) (number of holes = 12)	REF 163TA9029 (front, with bracket assembly) (Ø = 429,00 mm)	REF 143TA9738 (rubber) (450 x 81 x 72)
<i>S/N: 33181 - and up</i>				
REF 144TA8698 (Ø flange = 132,00 mm) (Ø body = 110,00 mm)	REF 144TA7721 (assembly) (Ø flange = 100,00 mm) (Ø body = 86,00 mm)	REF 163TA8964 (number of teeth = 21) (number of holes = 12)	REF 163TA9029 (front, with bracket assembly) (Ø = 429,00 mm)	REF 143TA9738 (rubber) (450 x 81 x 72)
HITACHI EX60-3				
REF 144TA8698 (Ø flange = 132,00 mm) (Ø body = 110,00 mm)	REF 144TA7722 (assembly) (Ø flange = 100,00 mm) (Ø body = 86,00 mm)	REF 163TA8964 (number of teeth = 21) (number of holes = 12)	REF 163TA9029 (front, with bracket assembly) (Ø = 429,00 mm)	REF 143TA9738 (rubber) (450 x 81 x 72) REF 163TA8936 (rubber) (450 x 81 x 76)
HITACHI EX60-5				
REF 144TA8699 (for rubber tracks) (Ø flange = 132,00 mm) (Ø body = 110,00 mm)	REF 144TA7723 (assembly) (for rubber tracks) (Ø flange = 103,00 mm) (Ø body = 86,30 mm)		REF 144TA7534 (front, with bracket assembly) (for rubber tracks) (Ø = 452,00 mm)	REF 143TA9738 (rubber) (450 x 81 x 72)
HITACHI EX60LC-3				
REF 144TA7819 (for rubber tracks) (Ø flange = 132,00 mm) (Ø body = 110,00 mm)	REF 144TA7724 (assembly) (for rubber tracks) (Ø flange = 100,00 mm) (Ø body = 86,00 mm)		REF 144TA7535 (front, with bracket assembly) (for rubber tracks)	REF 143TA9738 (rubber) (450 x 81 x 72)
HITACHI EX60LC-5				
REF 163TA8984 (Ø flange = 132,00 mm) (Ø body = 110,00 mm)	REF 144TA7725 (assembly) (Ø flange = 103,00 mm) (Ø body = 86,30 mm)	REF 163TA8965 (number of teeth = 21) (number of holes = 12)	REF 144TA7536 (front, with bracket assembly) (Ø = 452,00 mm)	REF 143TA9738 (rubber) (450 x 81 x 72)
HITACHI EX60UR				
<i>S/N: up to - 02199</i>				
REF 163TA8983 (Ø flange = 145,00 mm) (Ø body = 120,00 mm)	REF 163TA8998 (assembly) (Ø flange = 100,00 mm) (Ø body = 86,00 mm)	REF 144TA7651 (number of teeth = 21) (number of holes = 12)	REF 163TA9028 (front, with bracket assembly) (Ø = 429,00 mm)	REF 143TA9738 (rubber) (450 x 81 x 72)
<i>S/N: 02200 - 03102</i>				
REF 163TA8983 (Ø flange = 145,00 mm) (Ø body = 120,00 mm)	REF 163TA8999 (assembly)	REF 144TA7651 (number of teeth = 21) (number of holes = 12)	REF 163TA9028 (front, with bracket assembly) (Ø = 429,00 mm)	REF 143TA9738 (rubber) (450 x 81 x 72)



used for HITACHI				
TRACK ROLLER	TOP ROLLER	SPROCKET	IDLER	TRACK
<i>S/N: 03103 - and up</i>				
REF 163TA8983 (∅ flange = 145,00 mm) (∅ body = 120,00 mm)	REF 163TA9000 (assembly) (∅ flange = 100,00 mm) (∅ body = 86,00 mm)	REF 144TA7651 (number of teeth = 21) (number of holes = 12)	REF 163TA9028 (front, with bracket assembly) (∅ = 429,00 mm)	REF 143TA9738 (rubber) (450 x 81 x 72)
HITACHI EX60URG				
<i>S/N: up to - 02199</i>				
REF 163TA8983 (∅ flange = 145,00 mm) (∅ body = 120,00 mm)	REF 163TA8998 (assembly) (∅ flange = 100,00 mm) (∅ body = 86,00 mm)	REF 144TA7651 (number of teeth = 21) (number of holes = 12)	REF 163TA9028 (front, with bracket assembly) (∅ = 429,00 mm)	REF 143TA9738 (rubber) (450 x 81 x 72)
<i>S/N: 02200 - 03102</i>				
REF 163TA8983 (∅ flange = 145,00 mm) (∅ body = 120,00 mm)	REF 163TA8999 (assembly)	REF 144TA7651 (number of teeth = 21) (number of holes = 12)	REF 163TA9028 (front, with bracket assembly) (∅ = 429,00 mm)	REF 143TA9738 (rubber) (450 x 81 x 72)
<i>S/N: 03103 - and up</i>				
REF 163TA8983 (∅ flange = 145,00 mm) (∅ body = 120,00 mm)	REF 163TA9000 (assembly) (∅ flange = 100,00 mm) (∅ body = 86,00 mm)	REF 144TA7651 (number of teeth = 21) (number of holes = 12)	REF 163TA9028 (front, with bracket assembly) (∅ = 429,00 mm)	REF 143TA9738 (rubber) (450 x 81 x 72)
HITACHI EX75UR				
REF 144TA7821 (∅ flange = 132,00 mm) (∅ body = 110,00 mm)	REF 144TA7726 (assembly) (∅ flange = 100,00 mm) (∅ body = 86,00 mm)	REF 144TA7653 (number of teeth = 21) (number of holes = 12)	REF 144TA7537 (front, with bracket assembly)	REF 163TA8936 (rubber) (450 x 81 x 76)
HITACHI EX75UR-3				
<i>S/N: up to - 12529</i>				
REF 144TA7916 (standard)	REF 144TA7730 (assembly) (standard) (∅ flange = 100,00 mm) (∅ body = 86,00 mm)	REF 163TA8966 (standard) (number of teeth = 21) (number of holes = 12)	REF 144TA7539 (front, with bracket assembly) (standard)	REF 163TA8936 (rubber) (450 x 81 x 76)
REF 144TA7915 (for Europe) (∅ flange = 132,00 mm) (∅ body = 110,00 mm)	REF 144TA7729 (assembly) (for Europe) (∅ flange = 103,00 mm) (∅ body = 86,30 mm)	REF 163TA8965 (for Europe) (number of teeth = 21) (number of holes = 12)		REF 163TA8937 (rubber) (450 x 81 x 78)
<i>S/N: 12530 - and up</i>				
REF 144TA7916 (standard)	REF 144TA7730 (assembly) (standard) (∅ flange = 100,00 mm) (∅ body = 86,00 mm)	REF 163TA8966 (standard) (number of teeth = 21) (number of holes = 12)	REF 144TA7540 (front, with bracket assembly) (for Europe) (∅ = 452,00 mm)	REF 163TA8936 (rubber) (450 x 81 x 76)
REF 144TA7915 (for Europe) (∅ flange = 132,00 mm) (∅ body = 110,00 mm)	REF 144TA7729 (assembly) (for Europe) (∅ flange = 103,00 mm) (∅ body = 86,30 mm)	REF 163TA8965 (for Europe) (number of teeth = 21) (number of holes = 12)		REF 163TA8937 (rubber) (450 x 81 x 78)
HITACHI EX75UR-5				
REF 144TA8698 (standard) (∅ flange = 132,00 mm) (∅ body = 110,00 mm)	REF 163TA9000 (assembly) (standard) (∅ flange = 100,00 mm) (∅ body = 86,00 mm)		REF 163TA9030 (front, with bracket assembly) (standard)	REF 164TA1527 (rubber) (450 x 81 x 78)
REF 163TA8984 (for Europe) (∅ flange = 132,00 mm) (∅ body = 110,00 mm)	REF 144TA7732 (assembly) (for Europe) (∅ flange = 103,00 mm) (∅ body = 86,30 mm)		REF 144TA7544 (front, with bracket assembly) (for Europe) (∅ = 452,00 mm)	



used for HITACHI				
TRACK ROLLER	TOP ROLLER	SPROCKET	IDLER	TRACK
				
HITACHI EX8				
REF 163TA8985		REF 163TA9239	REF 143TA9585 (front, with bracket assembly)	REF 163TA8938 (rubber) (180 x 72 x 37)
HITACHI EX80				
REF 164TA2101	REF 163TA9001 (assembly)	REF 163TA8965 (number of teeth = 21) (number of holes = 12)	REF 163TA9032 (front, with bracket assembly) (Ø = 452,00 mm)	REF 163TA8937 (rubber) (450 x 81 x 78)
HITACHI EX8-0				
REF 144TA8700 (for rubber tracks)			REF 144TA7548 (front, with bracket assembly) (for rubber tracks) (Ø = 248,00 mm)	REF 143TA9740 (rubber) (180 x 72 x 37)
HITACHI EX80-5				
REF 144TA8699 (for rubber tracks) (Ø flange = 132,00 mm) (Ø body = 110,00 mm)	REF 144TA7734 (assembly) (for rubber tracks) (Ø flange = 103,00 mm) (Ø body = 86,30 mm)		REF 144TA7545 (front, with bracket assembly) (for rubber tracks) (Ø = 452,00 mm)	REF 143TA9741 (rubber) (450 x 81 x 74)
HITACHI EX80U				
REF 144TA7825 (Ø flange = 132,00 mm) (Ø body = 110,00 mm)	REF 144TA7735 (assembly) (Ø flange = 103,00 mm) (Ø body = 86,30 mm)	REF 163TA8965 (number of teeth = 21) (number of holes = 12)	REF 144TA7546 (front, with bracket assembly) (Ø = 452,00 mm)	REF 163TA8937 (rubber) (450 x 81 x 78)
HITACHI EX8-2				
REF 163TA8985		REF 163TA8967	REF 143TA9585 (front, with bracket assembly)	REF 163TA8938 (rubber) (180 x 72 x 37)
REF 144TA8700 (for rubber tracks)			REF 144TA7548 (front, with bracket assembly) (for rubber tracks) (Ø = 248,00 mm)	
HITACHI EX8-2B				
<i>S/N: up to - 03913</i>				
REF 163TA8986		REF 163TA9239	REF 163TA9031 (front, with bracket assembly)	REF 163TA8939 (rubber) (180 x 72 x 37)
<i>S/N: 03914 - and up</i>				
REF 163TA8986		REF 163TA9239	REF 163TA9031 (front, with bracket assembly)	REF 163TA8940 (rubber) (180 x 72 x 37)
HITACHI HE15				
REF 144TA7860 (for rubber tracks) (inner guide) (Ø flange = 95,00 mm) (Ø body = 75,00 mm)				REF 164TA3042 (rubber) (230 x 96 x 33)
HITACHI HX140B				
REF 144TA1911 (for rubber tracks) (Ø flange = 120,00 mm) (Ø body = 65,00 mm)	REF 163TA9002 (assembly) (for rubber tracks) (Ø body = 84,00 mm)	REF 163TA8962 (number of teeth = 19) (number of holes = 9)	REF 143TA9349 (front, with bracket assembly) (for rubber tracks)	REF 163TA8942 (rubber) (400 x 72,5 x 78) (non-marking)
HITACHI HX99B				
REF 144TA7867 (Ø flange = 120,00 mm) (Ø body = 95,00 mm)	REF 144TA7755 (assembly) (for rubber tracks) (Ø body = 80,00 mm)	REF 163TA8963 (number of teeth = 18) (number of holes = 12)	REF 143TA9347 (front, with bracket assembly) (Ø = 360,00 mm)	REF 163TA8941 (rubber) (400 x 72,5 x 78) (non-marking)
HITACHI ME15				
REF 144TA7870 (for rubber tracks) (inner guide) (Ø flange = 95,00 mm) (Ø body = 75,00 mm)				REF 164TA3064 (rubber) (230 x 73 x 43)



used for HITACHI				
TRACK ROLLER	TOP ROLLER	SPROCKET	IDLER	TRACK
				
HITACHI UE30				
REF 144TA7888 (for rubber tracks)		REF 144TA7684 (for rubber tracks) (number of teeth = 21) (number of holes = 12)	REF 144TA7598 (front, with bracket assembly) (for rubber tracks)	REF 143TA9742 (rubber) (320 x 100 x 44)
HITACHI UE40				
REF 144TA7889 (for rubber tracks)			REF 143TA9354 (front, with bracket assembly) (for rubber tracks)	REF 143TA9736 (rubber) (400 x 72,5 x 72)
HITACHI UE50				
REF 144TA7890 (for rubber tracks) (Ø flange = 128,00 mm) (Ø body = 94,00 mm)	REF 144TA7762 (assembly) (for rubber tracks) (Ø flange = 128,00 mm) (Ø body = 94,00 mm)		REF 144TA7599 (front, with bracket assembly) (for rubber tracks)	REF 143TA9736 (rubber) (400 x 72,5 x 72)
HITACHI ZX10U-2				
REF 163TA8987		REF 163TA8968	REF 163TA9033 (front, with bracket assembly)	REF 143TA9743 (rubber) (180 x 72 x 41)
HITACHI ZX110				
REF 144TA8701 (Ø flange = 166,00 mm) (Ø body = 137,00 mm)	REF 163TA9003 (assembly) (Ø flange = 118,00 mm) (Ø body = 100,00 mm)	REF 163TA8954 (number of teeth = 21) (number of holes = 16)	REF 163TA9034 (front, with bracket assembly)	
HITACHI ZX120				
REF 144TA8701 (Ø flange = 166,00 mm) (Ø body = 137,00 mm)	REF 163TA9003 (assembly) (Ø flange = 118,00 mm) (Ø body = 100,00 mm)	REF 163TA8954 (number of teeth = 21) (number of holes = 16)	REF 163TA9035 (front, with bracket assembly) (Ø = 490,00 mm)	
HITACHI ZX125US				
REF 144TA8701 (Ø flange = 166,00 mm) (Ø body = 137,00 mm)	REF 163TA9003 (assembly) (Ø flange = 118,00 mm) (Ø body = 100,00 mm)	REF 163TA8954 (number of teeth = 21) (number of holes = 16)	REF 163TA9034 (front, with bracket assembly)	
HITACHI ZX135UR				
REF 144TA8701 (Ø flange = 166,00 mm) (Ø body = 137,00 mm)	REF 163TA9003 (assembly) (Ø flange = 118,00 mm) (Ø body = 100,00 mm)	REF 163TA8969 (number of teeth = 21) (number of holes = 16)	REF 163TA9034 (front, with bracket assembly)	
HITACHI ZX135US				
REF 144TA8701 (Ø flange = 166,00 mm) (Ø body = 137,00 mm)	REF 163TA9003 (assembly) (Ø flange = 118,00 mm) (Ø body = 100,00 mm)	REF 163TA8969 (number of teeth = 21) (number of holes = 16)	REF 163TA9034 (front, with bracket assembly)	
HITACHI ZX14				
REF 144TA8703 (for rubber tracks) (Ø flange = 95,00 mm) (Ø body = 75,00 mm)		REF 140TA8925 (for rubber tracks) (number of teeth = 19) (number of holes = 9)	REF 144TA7513 (front, with bracket assembly) (for rubber tracks) (Ø = 249,00 mm)	
HITACHI ZX14-3				
REF 163TA8978 (Ø flange = 95,00 mm) (Ø body = 75,00 mm)		REF 163TA8970 (number of teeth = 19) (number of holes = 9)	REF 163TA9036 (front, with bracket assembly) (Ø = 249,00 mm)	REF 163TA8944 (rubber) (230 x 48 x 62)



used for HITACHI				
TRACK ROLLER	TOP ROLLER	SPROCKET	IDLER	TRACK
				
HITACHI ZX16				
REF 144TA7895 (for rubber tracks) (Ø flange = 95,00 mm) (Ø body = 75,00 mm)		REF 140TA8925 (number of teeth = 19) (number of holes = 9)	REF 163TA9037 (front, with bracket assembly) (Ø = 249,00 mm)	REF 164TA3042 (rubber) (230 x 96 x 33)
REF 143TA8855 (for rubber tracks)				
REF 163TA8978 (for steel tracks) (Ø flange = 95,00 mm) (Ø body = 75,00 mm)				
HITACHI ZX17				
REF 144TA7895 (for rubber tracks) (inner guide) (Ø flange = 95,00 mm) (Ø body = 75,00 mm)		REF 140TA8925 (for rubber tracks) (number of teeth = 19) (number of holes = 9)	REF 144TA7515 (front, with bracket assembly) (for rubber tracks) (Ø = 249,00 mm)	REF 164TA3042 (rubber) (230 x 96 x 33)
HITACHI ZX17U-2				
REF 144TA7896 (Ø flange = 95,00 mm) (Ø body = 75,00 mm)		REF 144TA7688 (number of teeth = 19) (number of holes = 9)	REF 163TA9014 (front, with bracket assembly) (Ø = 249,00 mm)	REF 163TA8945 (rubber) (230 x 86 x 35)
REF 143TA8855		REF 144TA7687 (for rubber tracks) (number of teeth = 19) (number of holes = 9)		
REF 163TA8978 (for steel tracks) (Ø flange = 95,00 mm) (Ø body = 75,00 mm)				
HITACHI ZX18				
REF 164TA2102 (Ø = 110,00 mm)		REF 144TA7689 (number of teeth = 19) (number of holes = 9)	REF 163TA9037 (front, with bracket assembly) (Ø = 249,00 mm)	REF 164TA3042 (rubber) (230 x 96 x 33)
REF 144TA7899 (for rubber and steel tracks) (Ø flange = 95,00 mm) (Ø body = 75,00 mm)				
HITACHI ZX22U-2				
<i>S/P: 1MW</i>				
REF 144TA7921 (for rubber tracks) (Ø flange = 108,00 mm) (Ø body = 85,00 mm)				REF 143TA9745 (rubber) (250 x 52,5 x 77)
HITACHI ZX25				
REF 144TA1772 (for rubber tracks) (Ø flange = 108,00 mm) (Ø body = 85,00 mm)		REF 144TA7691 (for rubber tracks)	REF 163TA9017 (front, with bracket assembly) (Ø = 307,00 mm)	REF 163TA8946 (rubber) (250 x 52,5 x 73)
HITACHI ZX27-3				
		REF 144TA7692 (for rubber tracks) (number of teeth = 23) (number of holes = 9)		REF 164TA3037 (rubber) (300 x 52,5 x 80)
HITACHI ZX27U				
REF 144TA7901 (Ø flange = 108,00 mm) (Ø body = 85,00 mm)	REF 163TA8990 (assembly) (Ø body = 84,00 mm)	REF 163TA8956 (number of teeth = 21) (number of holes = 11)	REF 163TA9038 (front, with bracket assembly) (Ø = 316,00 mm)	REF 163TA8930 (rubber) (300 x 52,5 x 78)
HITACHI ZX27U-2				
REF 144TA7902 (Ø flange = 108,00 mm) (Ø body = 85,00 mm)	REF 144TA7765 (assembly) (Ø body = 70,00 mm)	REF 144TA7694 (number of teeth = 23) (number of holes = 9)	REF 163TA9039 (front, with bracket assembly) (Ø = 338,00 mm)	REF 164TA3037 (rubber) (300 x 52,5 x 80)

TRACKS & UNDERCARRIAGE PARTS



used for HITACHI

used for HITACHI				
TRACK ROLLER	TOP ROLLER	SPROCKET	IDLER	TRACK
				
HITACHI ZX27U-3				
REF 144TA7903 (∅ flange = 108,00 mm) (∅ body = 85,00 mm)	REF 163TA8990 (assembly) (∅ body = 84,00 mm) REF 163TA9004 (assembly) (∅ body = 70,00 mm)	REF 163TA8957 (number of teeth = 21) (number of holes = 9)		REF 164TA3037 (rubber) (300 x 52,5 x 80)
HITACHI ZX30				
REF 144TA7904 (∅ flange = 108,00 mm) (∅ body = 85,00 mm)	REF 144TA7767 (assembly) (∅ body = 80,00 mm)	REF 163TA8956 (number of teeth = 21) (number of holes = 11)	REF 163TA9016 (front, with bracket assembly) (∅ = 307,00 mm)	REF 143TA9746 (rubber) (300 x 52,5 x 82)
HITACHI ZX30U				
<i>S/N: 05001 - 07000</i>				
REF 144TA1772 (∅ flange = 108,00 mm) (∅ body = 85,00 mm)	REF 163TA8990 (assembly) (∅ body = 84,00 mm)	REF 163TA8956 (number of teeth = 21) (number of holes = 11)	REF 163TA9016 (front, with bracket assembly) (∅ = 307,00 mm)	REF 163TA8929 (rubber) (300 x 52,5 x 86)
<i>S/N: 07001 - and up</i>				
REF 144TA1772 (∅ flange = 108,00 mm) (∅ body = 85,00 mm)	REF 163TA9004 (assembly) (∅ body = 70,00 mm)	REF 163TA8957 (number of teeth = 21) (number of holes = 9)	REF 143TA9355 (front, with bracket assembly)	REF 163TA8947 (rubber) (300 x 52,5 x 86)
HITACHI ZX30U-1				
REF 144TA7905 (for rubber tracks) (∅ flange = 108,00 mm) (∅ body = 85,00 mm)	REF 144TA7768 (assembly) (for rubber tracks) (∅ body = 70,00 mm)		REF 143TA9355 (front, with bracket assembly) (for rubber tracks)	REF 143TA9746 (rubber) (300 x 52,5 x 82)
HITACHI ZX30U-2				
REF 144TA7906 (∅ flange = 108,00 mm) (∅ body = 85,00 mm)	REF 144TA7769 (assembly) (∅ body = 70,00 mm)	REF 163TA8957 (number of teeth = 21) (number of holes = 9)	REF 143TA9355 (front, with bracket assembly)	REF 143TA9746 (rubber) (300 x 52,5 x 82)
HITACHI ZX30U-3				
REF 144TA7907 (∅ flange = 108,00 mm) (∅ body = 85,00 mm)	REF 144TA7770 (assembly) (∅ body = 70,00 mm)	REF 163TA8957 (number of teeth = 21) (number of holes = 9)	REF 163TA9015 (front, with bracket assembly)	REF 143TA9746 (rubber) (300 x 52,5 x 82)
HITACHI ZX30UR				
REF 144TA1772 (∅ flange = 108,00 mm) (∅ body = 85,00 mm)	REF 163TA8990 (assembly) (∅ body = 84,00 mm)	REF 163TA8956 (number of teeth = 21) (number of holes = 11)	REF 163TA9016 (front, with bracket assembly) (∅ = 307,00 mm)	REF 163TA8929 (rubber) (300 x 52,5 x 86)
HITACHI ZX33U				
REF 144TA1772 (for rubber tracks) (∅ flange = 108,00 mm) (∅ body = 85,00 mm)				
HITACHI ZX35				
REF 144TA7908 (∅ flange = 108,00 mm) (∅ body = 85,00 mm)	REF 144TA7771 (assembly) (∅ body = 80,00 mm)	REF 144TA7697	REF 163TA9016 (front, with bracket assembly) (∅ = 307,00 mm)	REF 143TA9746 (rubber) (300 x 52,5 x 82)
HITACHI ZX35U-2				
REF 144TA7909 (∅ flange = 108,00 mm) (∅ body = 85,00 mm)	REF 144TA7772 (assembly) (∅ body = 70,00 mm)	REF 144TA7698 (number of teeth = 23) (number of holes = 9)	REF 143TA9355 (front, with bracket assembly)	REF 163TA8947 (rubber) (300 x 52,5 x 86)
HITACHI ZX35U-3				
				REF 163TA9465 (rubber) (300 x 52,5 x 86)

TRACKS & UNDERCARRIAGE PARTS



used for HITACHI

used for HITACHI				
TRACK ROLLER	TOP ROLLER	SPROCKET	IDLER	TRACK
				
HITACHI ZX40U-1				
REF 144TA7922 (for rubber tracks) (Ø flange = 120,00 mm) (Ø body = 95,00 mm)	REF 144TA7773 (assembly) (for rubber tracks) (Ø body = 80,00 mm)			REF 143TA9736 (rubber) (400 x 72,5 x 72)
HITACHI ZX40U-2				
REF 163TA8988 (Ø flange = 170,00 mm) (Ø body = 95,00 mm)	REF 144TA7774 (assembly) (Ø body = 70,30 mm)	REF 163TA8971 (number of teeth = 19) (number of holes = 12)	REF 163TA9040 (front, with bracket assembly) (Ø = 356,00 mm)	REF 163TA8948 (rubber) (400 x 72,5 x 74)
HITACHI ZX40UR				
REF 144TA1772 (Ø flange = 108,00 mm) (Ø body = 85,00 mm)	REF 163TA8990 (assembly) (Ø body = 84,00 mm)	REF 163TA8956 (number of teeth = 21) (number of holes = 11)	REF 163TA9016 (front, with bracket assembly) (Ø = 307,00 mm)	REF 164TA9670 (rubber) (300 x 52,5 x 86)
HITACHI ZX48U				
REF 144TA1911 (for rubber tracks) (Ø flange = 120,00 mm) (Ø body = 65,00 mm)				
HITACHI ZX50				
REF 144TA7910 (Ø flange = 120,00 mm) (Ø body = 95,00 mm)	REF 144TA7775 (assembly) (Ø body = 80,00 mm)	REF 163TA8963 (number of teeth = 18) (number of holes = 12)	REF 143TA9347 (front, with bracket assembly) (Ø = 360,00 mm)	REF 143TA9736 (rubber) (400 x 72,5 x 72)
HITACHI ZX50U				
<i>S/P: 1LE - S/N: 05001 - 07000</i>				
REF 144TA7924 (Ø flange = 120,00 mm) (Ø body = 95,00 mm)	REF 163TA8990 (assembly) (Ø body = 84,00 mm)	REF 163TA8972 (number of teeth = 18) (number of holes = 12)	REF 143TA9347 (front, with bracket assembly) (Ø = 360,00 mm)	REF 143TA9736 (rubber) (400 x 72,5 x 72)
<i>S/P: 1LE - S/N: 07001 - and up</i>				
REF 163TA8988 (Ø flange = 170,00 mm) (Ø body = 95,00 mm)	REF 163TA9005 (assembly) (Ø body = 70,30 mm)	REF 163TA8972 (number of teeth = 18) (number of holes = 12)	REF 163TA9040 (front, with bracket assembly) (Ø = 356,00 mm)	REF 140TA8644 (rubber) (400 x 72,5 x 74)
HITACHI ZX50U-2				
REF 144TA7910 (Ø flange = 120,00 mm) (Ø body = 95,00 mm)	REF 163TA9005 (assembly) (Ø body = 70,30 mm)	REF 163TA8971 (number of teeth = 19) (number of holes = 12)	REF 163TA9040 (front, with bracket assembly) (Ø = 356,00 mm)	REF 163TA8948 (rubber) (400 x 72,5 x 74)
HITACHI ZX52				
REF 144TA7911 (for rubber tracks) (Ø flange = 170,00 mm) (Ø body = 95,00 mm)	REF 144TA7778 (assembly) (for rubber tracks) (Ø body = 70,30 mm)		REF 144TA7615 (front, with bracket assembly) (for rubber tracks) (Ø = 356,00 mm)	REF 140TA8644 (rubber) (400 x 72,5 x 74)
HITACHI ZX55U				
REF 144TA1911 (for rubber tracks) (Ø flange = 120,00 mm) (Ø body = 65,00 mm)				
HITACHI ZX55UR				
REF 144TA1911 (Ø flange = 120,00 mm) (Ø body = 65,00 mm)	REF 163TA8990 (assembly) (Ø body = 84,00 mm)	REF 163TA8973 (number of teeth = 19) (number of holes = 9)	REF 143TA9349 (front, with bracket assembly)	REF 163TA8935 (rubber) (400 x 72,5 x 72)
HITACHI ZX60USB				
REF 144TA1911 (for rubber tracks) (Ø flange = 120,00 mm) (Ø body = 65,00 mm)				
HITACHI ZX60USB-3				
REF 144TA8705 (Ø flange = 139,00 mm) (Ø body = 110,00 mm)	REF 144TA7779 (assembly) (Ø body = 80,00 mm)	REF 144TA8706 (number of teeth = 19) (number of holes = 12)	REF 143TA9358 (front, with bracket assembly)	REF 164TA3015 (rubber) (400 x 72,5 x 74)



used for HITACHI				
TRACK ROLLER	TOP ROLLER	SPROCKET	IDLER	TRACK
				
HITACHI ZX70				
REF 144TA8699 (Ø flange = 132,00 mm) (Ø body = 110,00 mm)	REF 163TA9006 (assembly) (Ø flange = 103,00 mm) (Ø body = 86,30 mm)	REF 163TA8965 (number of teeth = 21) (number of holes = 12)	REF 163TA9032 (front, with bracket assembly) (Ø = 452,00 mm)	
HITACHI ZX75UR				
REF 144TA8699 (Ø flange = 132,00 mm) (Ø body = 110,00 mm)	REF 163TA9006 (assembly) (Ø flange = 103,00 mm) (Ø body = 86,30 mm)	REF 163TA8965 (number of teeth = 21) (number of holes = 12)	REF 163TA9032 (front, with bracket assembly) (Ø = 452,00 mm)	
HITACHI ZX75US				
REF 144TA8699 (Ø flange = 132,00 mm) (Ø body = 110,00 mm)	REF 163TA9006 (assembly) (Ø flange = 103,00 mm) (Ø body = 86,30 mm)	REF 163TA8965 (number of teeth = 21) (number of holes = 12)	REF 163TA9032 (front, with bracket assembly) (Ø = 452,00 mm)	REF 163TA8937 (rubber) (450 x 81 x 78)
HITACHI ZX80UR				
REF 144TA8699 (for rubber tracks) (Ø flange = 132,00 mm) (Ø body = 110,00 mm)				
HITACHI ZX80US				
REF 144TA8699 (for rubber tracks) (Ø flange = 132,00 mm) (Ø body = 110,00 mm)				
HITACHI ZX8-2				
REF 163TA8987		REF 163TA8968	REF 163TA9033 (front, with bracket assembly)	REF 163TA8951 (rubber) (180 x 72 x 37)
HITACHI ZX85US				
REF 144TA7912 (for rubber tracks) (Ø flange = 132,00 mm) (Ø body = 110,00 mm)	REF 144TA7780 (assembly) (for rubber tracks) (Ø flange = 103,00 mm) (Ø body = 86,30 mm)		REF 144TA7617 (front, with bracket assembly) (for rubber tracks) (Ø = 452,00 mm)	REF 164TA1527 (rubber) (450 x 81 x 78)
HITACHI ZX85USB-3				
REF 144TA7913 (Ø flange = 132,00 mm) (Ø body = 110,00 mm)	REF 144TA7781 (assembly) (Ø flange = 103,00 mm) (Ø body = 86,30 mm)		REF 144TA7618 (front, with bracket assembly) (Ø = 452,00 mm)	REF 164TA1527 (rubber) (450 x 81 x 78)
HITACHI ZX8U-2				
REF 163TA8987		REF 163TA8968	REF 163TA9033 (front, with bracket assembly)	REF 163TA8951 (rubber) (180 x 72 x 37)
HITACHI ZX95				
REF 144TA8701 (for rubber tracks) (Ø flange = 166,00 mm) (Ø body = 137,00 mm)				



USED FOR
HYUNDAI

TRACKS & UNDERCARRIAGE PARTS



used for HYUNDAI

used for HYUNDAI				
TRACK ROLLER	TOP ROLLER	SPROCKET	IDLER	TRACK
				
HYUNDAI R15-7				
REF 163TA9967 (for rubber and steel tracks)		REF 163TA9939 (for rubber and steel tracks) (number of teeth = 19) (number of holes = 8)	REF 163TA9997 (front, with bracket assembly) (for rubber and steel tracks)	REF 163TA9909 (rubber) (230 x 48 x 66) REF 163TA9927 (steel)
HYUNDAI R16-7				
REF 163TA9967 (for rubber and steel tracks)		REF 163TA9939 (for rubber and steel tracks) (number of teeth = 19) (number of holes = 8)	REF 163TA9997 (front, with bracket assembly) (for rubber and steel tracks)	REF 163TA9909 (rubber) (230 x 48 x 66) REF 163TA9927 (steel)
HYUNDAI R16-9				
<i>S/N: up to - 0027</i>				
REF 144TA8692 (for rubber tracks)		REF 144TA8691 (for rubber tracks) (number of teeth = 19) (number of holes = 9)	REF 144TA8695 (front, with bracket assembly) (for rubber tracks)	REF 163TA9900 (rubber) (230 x 48 x 70)
<i>S/N: 0028 - 0079</i>				
		REF 144TA8691 (for rubber tracks) (number of teeth = 19) (number of holes = 9)	REF 144TA8696 (front, with bracket assembly) (for rubber tracks) (Ø = 240,00 mm)	REF 163TA9900 (rubber) (230 x 48 x 70)
<i>S/N: 0028 - 0235</i>				
REF 144TA8693 (for rubber tracks)		REF 144TA8691 (for rubber tracks) (number of teeth = 19) (number of holes = 9)		REF 163TA9900 (rubber) (230 x 48 x 70)
<i>S/N: 0080 - and up</i>				
		REF 144TA8691 (for rubber tracks) (number of teeth = 19) (number of holes = 9)	REF 144TA8697 (front, with bracket assembly) (for rubber tracks) (Ø = 240,00 mm)	REF 163TA9900 (rubber) (230 x 48 x 70)
<i>S/N: 0236 - and up</i>				
REF 144TA8694 (for rubber tracks) (Ø flange = 110,00 mm) (Ø body = 70,00 mm)		REF 144TA8691 (for rubber tracks) (number of teeth = 19) (number of holes = 9)		REF 163TA9900 (rubber) (230 x 48 x 70)
HYUNDAI R17Z-9A				
REF 163TA9953 (for rubber tracks)		REF 144TA8691 (for rubber tracks) (number of teeth = 19) (number of holes = 9)	REF 163TA9985 (front, with bracket assembly) (for rubber tracks)	REF 164TA2030 (rubber) (230 x 48 x 70) (with rail)
HYUNDAI R22-7				
REF 163TA9968 (for rubber and steel tracks)		REF 163TA9940 (for rubber and steel tracks)	REF 163TA9997 (front, with bracket assembly) (for rubber and steel tracks)	REF 163TA9910 (rubber) (230 x 48 x 74)

TRACKS & UNDERCARRIAGE PARTS



used for HYUNDAI

used for HYUNDAI				
TRACK ROLLER	TOP ROLLER	SPROCKET	IDLER	TRACK
				
HYUNDAI R25Z-9A				
<i>S/N: up to - 0003</i>				
REF 163TA9954 (for rubber tracks) (rail and interlocking type)	REF 163TA9979 (assembly) (for rubber tracks) (rail and interlocking type)	REF 144TA8690 (for rubber tracks) (rail and interlocking type)	REF 163TA9986 (front, with bracket assembly) (for rubber tracks) (rail and interlocking type)	REF 163TA9901 (rubber) (250 x 52,5 x 78) (with rail)
<i>S/N: 0004 - and up</i>				
REF 163TA9955 (for rubber tracks) (rail and interlocking type)	REF 163TA9979 (assembly) (for rubber tracks) (rail and interlocking type)	REF 144TA8690 (for rubber tracks) (rail and interlocking type)	REF 163TA9986 (front, with bracket assembly) (for rubber tracks) (rail and interlocking type)	REF 163TA9902 (rubber) (250 x 52,5 x 78) (with rail)
<i>S/N: 0209 - and up</i>				
	REF 163TA9979 (assembly) (for rubber tracks) (rail and interlocking type)	REF 144TA8690 (for rubber tracks) (rail and interlocking type)	REF 163TA9986 (front, with bracket assembly) (for rubber tracks) (rail and interlocking type)	REF 163TA9903 (rubber) (250 x 52,5 x 78) (with rail)
HYUNDAI R25Z-9AK				
REF 163TA9955 (for rubber tracks) (rail and interlocking type)	REF 163TA9979 (assembly) (for rubber tracks) (rail and interlocking type)	REF 144TA8690 (for rubber tracks) (rail and interlocking type)	REF 163TA9986 (front, with bracket assembly) (for rubber tracks) (rail and interlocking type)	REF 163TA9902 (rubber) (250 x 52,5 x 78) (with rail) REF 163TA9903 (rubber) (250 x 52,5 x 78) (with rail)
HYUNDAI R27Z-9				
<i>S/N: up to - 0036</i>				
REF 144TA8688 (for rubber tracks)		REF 144TA8690 (for rubber tracks)	REF 163TA9987 (front, with bracket assembly) (for rubber tracks) REF 163TA9986 (front, with bracket assembly) (for rubber tracks) (interlocking type)	
<i>S/N: up to - 0106</i>				
	REF 144TA8689 (assembly) (for rubber tracks) (Ø body = 70,30 mm)	REF 144TA8690 (for rubber tracks)	REF 163TA9986 (front, with bracket assembly) (for rubber tracks) (interlocking type)	
<i>S/N: up to - 0862</i>				
REF 163TA9954 (for rubber tracks) (interlocking type)		REF 144TA8690 (for rubber tracks)	REF 163TA9986 (front, with bracket assembly) (for rubber tracks) (interlocking type)	REF 163TA9904 (rubber) (300 x 52,5 x 80)
<i>S/N: 0037 - 0106</i>				
REF 163TA9956 (for rubber tracks)		REF 144TA8690 (for rubber tracks)	REF 163TA9988 (front, with bracket assembly) (for rubber tracks) REF 163TA9986 (front, with bracket assembly) (for rubber tracks) (interlocking type)	
<i>S/N: 0107 - 0315</i>				
REF 163TA9957 (for rubber tracks)		REF 144TA8690 (for rubber tracks)	REF 163TA9989 (front, with bracket assembly) (for rubber tracks)	

TRACKS & UNDERCARRIAGE PARTS



used for HYUNDAI

used for HYUNDAI				
TRACK ROLLER	TOP ROLLER	SPROCKET	IDLER	TRACK
				
			REF 163TA9986 (front, with bracket assembly) (for rubber tracks) (interlocking type)	
<i>S/N: 0107 - and up</i>				
	REF 163TA9979 (assembly) (for rubber tracks)	REF 144TA8690 (for rubber tracks)	REF 163TA9986 (front, with bracket assembly) (for rubber tracks) (interlocking type)	
<i>S/N: 0316 - 0862</i>				
REF 163TA9954 (for rubber tracks)		REF 144TA8690 (for rubber tracks)	REF 163TA9986 (front, with bracket assembly) (for rubber tracks) (interlocking type)	
<i>S/N: 0316 - and up</i>				
		REF 144TA8690 (for rubber tracks)	REF 163TA9986 (front, with bracket assembly) (for rubber tracks)	
<i>S/N: 0811 - and up</i>				
	REF 163TA9979 (assembly) (for rubber tracks) (interlocking type)	REF 144TA8690 (for rubber tracks)	REF 163TA9986 (front, with bracket assembly) (for rubber tracks) (interlocking type)	REF 164TA2029 (rubber) (300 x 52,5 x 80)
<i>S/N: 0863 - and up</i>				
REF 163TA9955 (for rubber tracks)		REF 144TA8690 (for rubber tracks)	REF 163TA9986 (front, with bracket assembly) (for rubber tracks) (interlocking type)	REF 164TA2028 (rubber) (300 x 52,5 x 80)
REF 163TA9955 (for rubber tracks) (interlocking type)				
HYUNDAI R28-7				
REF 163TA9330 (for rubber and steel tracks) (Ø flange = 113,00 mm) (Ø body = 95,00 mm)	REF 163TA9332 (assembly) (for rubber and steel tracks) (Ø body = 75,00 mm)	REF 163TA9442 (for rubber and steel tracks)	REF 163TA9331 (front, with bracket assembly) (for rubber and steel tracks) (Ø = 311,00 mm)	REF 164TA9668 (rubber) (300 x 52,5 x 74) REF 163TA9333 (steel)
HYUNDAI R35-7				
REF 163TA9330 (for rubber and steel tracks) (Ø flange = 113,00 mm) (Ø body = 95,00 mm)	REF 163TA9332 (assembly) (for steel tracks) (Ø body = 75,00 mm)	REF 163TA9941 (for rubber and steel tracks) (number of teeth = 21) (number of holes = 12)	REF 163TA9331 (front, with bracket assembly) (for rubber and steel tracks) (Ø = 311,00 mm)	REF 163TA9911 (rubber) (300 x 52,5 x 86) REF 163TA9929 (steel)
HYUNDAI R35Z-7				
<i>S/N: up to - 0246</i>				
REF 163TA9969 (for steel tracks)	REF 163TA9983 (assembly) (for rubber and steel tracks) (interlocking and non-interlocking type)	REF 163TA9942 (for rubber and steel tracks) (interlocking and non-interlocking type)		REF 163TA9912 (rubber) (300 x 52,5 x 86) REF 163TA9930 (steel)
REF 163TA9970 (for rubber tracks) (interlocking and non-interlocking type)				

TRACKS & UNDERCARRIAGE PARTS



used for HYUNDAI

used for HYUNDAI				
TRACK ROLLER	TOP ROLLER	SPROCKET	IDLER	TRACK
				
<i>S/N: up to - 0325</i>				
REF 163TA9969 (for steel tracks)	REF 163TA9983 (assembly) (for rubber and steel tracks) (interlocking and non-interlocking type)	REF 163TA9942 (for rubber and steel tracks) (interlocking and non-interlocking type)	REF 163TA9990 (front, with bracket assembly) (for steel tracks)	REF 163TA9930 (steel)
REF 163TA9970 (for rubber tracks) (interlocking and non-interlocking type)			REF 163TA9998 (front, with bracket assembly) (for rubber tracks) (interlocking and non-interlocking type)	
<i>S/N: 0247 - and up</i>				
REF 163TA9969 (for steel tracks)	REF 163TA9983 (assembly) (for rubber and steel tracks) (interlocking and non-interlocking type)	REF 163TA9942 (for rubber and steel tracks) (interlocking and non-interlocking type)		REF 163TA9905 (rubber) (300 x 52,5 x 86)
REF 163TA9970 (for rubber tracks) (interlocking and non-interlocking type)				REF 163TA9930 (steel)
<i>S/N: 0325 - and up</i>				
REF 163TA9969 (for steel tracks)	REF 163TA9983 (assembly) (for rubber and steel tracks) (interlocking and non-interlocking type)	REF 163TA9942 (for rubber and steel tracks) (interlocking and non-interlocking type)		REF 164TA2027 (rubber) (300 x 52,5 x 86)
REF 163TA9970 (for rubber tracks) (interlocking and non-interlocking type)				REF 163TA9930 (steel)
<i>S/N: 0326 - and up</i>				
REF 163TA9969 (for steel tracks)	REF 163TA9983 (assembly) (for rubber and steel tracks) (interlocking and non-interlocking type)	REF 163TA9942 (for rubber and steel tracks) (interlocking and non-interlocking type)	REF 163TA9991 (front, with bracket assembly) (for steel tracks)	REF 163TA9930 (steel)
REF 163TA9970 (for rubber tracks) (interlocking and non-interlocking type)			REF 163TA9992 (front, with bracket assembly) (for rubber tracks) (interlocking and non-interlocking type)	
HYUNDAI R35Z-7A				
<i>S/N: up to - 0006</i>				
		REF 163TA9942 (for rubber and steel tracks) (interlocking and non-interlocking type)	REF 164TA1000 (front, with bracket assembly) (for rubber tracks)	REF 163TA9930 (steel)
			REF 163TA9999 (front, with bracket assembly) (for steel tracks)	
<i>S/N: up to - 0063</i>				
		REF 163TA9942 (for rubber and steel tracks) (interlocking and non-interlocking type)		REF 163TA9912 (rubber) (300 x 52,5 x 86)
				REF 163TA9930 (steel)

TRACKS & UNDERCARRIAGE PARTS



used for HYUNDAI

used for HYUNDAI				
TRACK ROLLER	TOP ROLLER	SPROCKET	IDLER	TRACK
				
<i>S/N: up to - 0264</i>				
REF 163TA9969 (for steel tracks)	REF 163TA9983 (assembly) (for rubber and steel tracks)	REF 163TA9942 (for rubber and steel tracks) (interlocking and non-interlocking type)		REF 163TA9930 (steel)
REF 163TA9970 (for rubber tracks)				
<i>S/N: 0007 - 0264</i>				
		REF 163TA9942 (for rubber and steel tracks) (interlocking and non-interlocking type)	REF 163TA9998 (front, with bracket assembly) (for rubber and steel tracks)	REF 163TA9930 (steel)
<i>S/N: 0064 - 0669</i>				
		REF 163TA9942 (for rubber and steel tracks) (interlocking and non-interlocking type)		REF 163TA9905 (rubber) (300 x 52,5 x 86)
<i>S/N: 0264 - 0439</i>				
		REF 163TA9942 (for rubber and steel tracks) (interlocking and non-interlocking type)	REF 163TA9991 (front, with bracket assembly) (for steel tracks)	REF 163TA9930 (steel)
<i>S/N: 0265 - 0439</i>				
		REF 163TA9942 (for rubber and steel tracks) (interlocking and non-interlocking type)	REF 163TA9992 (front, with bracket assembly) (for rubber tracks)	REF 163TA9930 (steel)
<i>S/N: 0265 - 0669</i>				
REF 163TA9971 (for steel tracks)		REF 163TA9942 (for rubber and steel tracks) (interlocking and non-interlocking type)		REF 163TA9930 (steel)
REF 163TA9962 (for rubber tracks)				
<i>S/N: 0265 - and up</i>				
	REF 163TA9984 (assembly) (for rubber and steel tracks)	REF 163TA9942 (for rubber and steel tracks) (interlocking and non-interlocking type)		REF 163TA9930 (steel)
<i>S/N: 0440 - 0669</i>				
		REF 163TA9942 (for rubber and steel tracks) (interlocking and non-interlocking type)	REF 164TA1001 (front, with bracket assembly) (for rubber tracks)	REF 163TA9930 (steel)
<i>S/N: 0440 - and up</i>				
		REF 163TA9942 (for rubber and steel tracks) (interlocking and non-interlocking type)	REF 163TA9993 (front, with bracket assembly) (for steel tracks)	REF 163TA9930 (steel)
<i>S/N: 0639 - 0669</i>				
REF 163TA9962 (for rubber tracks) (interlocking type)		REF 163TA9942 (for rubber and steel tracks) (interlocking and non-interlocking type)	REF 164TA1001 (front, with bracket assembly) (for rubber tracks) (interlocking type)	REF 163TA9930 (steel)

TRACKS & UNDERCARRIAGE PARTS



used for HYUNDAI

used for HYUNDAI				
TRACK ROLLER	TOP ROLLER	SPROCKET	IDLER	TRACK
				
<i>S/N: 0639 - and up</i>				
	REF 163TA9984 (assembly) (for rubber tracks) (interlocking type)	REF 163TA9942 (for rubber and steel tracks) (interlocking and non-interlocking type)		REF 164TA2027 (rubber) (300 x 52,5 x 86) REF 163TA9930 (steel)
<i>S/N: 0670 - and up</i>				
REF 163TA9959 (for steel tracks) REF 164TA2103 (for rubber tracks) (interlocking and non-interlocking type)		REF 163TA9942 (for rubber and steel tracks) (interlocking and non-interlocking type)	REF 164TA2132 (front, with bracket assembly) (for rubber tracks) (interlocking and non-interlocking type)	REF 164TA2031 (steel) REF 163TA9930 (steel)
HYUNDAI R35Z-9				
<i>S/N: up to - 0020</i>				
REF 163TA9958 (for steel tracks) REF 163TA9960 (for rubber tracks)	REF 163TA9980 (assembly) (for rubber and steel tracks)	REF 163TA9937 (for rubber and steel tracks) (interlocking and non-interlocking type)	REF 163TA9990 (front, with bracket assembly) (for rubber and steel tracks)	REF 163TA9924 (steel)
<i>S/N: up to - 1025</i>				
		REF 163TA9937 (for rubber and steel tracks) (interlocking and non-interlocking type)		REF 163TA9905 (rubber) (300 x 52,5 x 86) REF 163TA9924 (steel)
<i>S/N: 0021 - 1025</i>				
REF 163TA9961 (for rubber tracks)		REF 163TA9937 (for rubber and steel tracks) (interlocking and non-interlocking type)		REF 163TA9924 (steel)
<i>S/N: 0021 - and up</i>				
REF 163TA9959 (for steel tracks)	REF 163TA9981 (assembly) (for rubber and steel tracks)	REF 163TA9937 (for rubber and steel tracks) (interlocking and non-interlocking type)	REF 163TA9992 (front, with bracket assembly) (for rubber and steel tracks)	REF 163TA9924 (steel)
<i>S/N: 0946 - 1025</i>				
REF 163TA9961 (for rubber tracks) (interlocking type)		REF 163TA9937 (for rubber and steel tracks) (interlocking and non-interlocking type)		REF 163TA9924 (steel)
<i>S/N: 0946 - and up</i>				
	REF 163TA9981 (assembly) (for rubber tracks) (interlocking type)	REF 163TA9937 (for rubber and steel tracks) (interlocking and non-interlocking type)	REF 163TA9992 (front, with bracket assembly) (for rubber tracks) (interlocking type)	REF 164TA2027 (rubber) (300 x 52,5 x 86) REF 163TA9924 (steel)







used for HYUNDAI

used for HYUNDAI				
TRACK ROLLER	TOP ROLLER	SPROCKET	IDLER	TRACK
				
<i>S/N: 1026 - and up</i>				
REF 163TA9962 (for rubber tracks) (interlocking and non-interlocking type)		REF 163TA9937 (for rubber and steel tracks) (interlocking and non-interlocking type)		REF 163TA9906 (rubber) (300 x 52,5 x 86) (with rail) REF 163TA9924 (steel)
HYUNDAI R35Z-9A				
REF 163TA9959 (for steel tracks)	REF 163TA9981 (assembly) (for rubber and steel tracks)	REF 163TA9937 (for rubber and steel tracks)	REF 163TA9993 (front, with bracket assembly) (for steel tracks)	REF 163TA9906 (rubber) (300 x 52,5 x 86) (with rail)
REF 163TA9963 (for rubber tracks)			REF 163TA9994 (front, with bracket assembly) (for rubber tracks)	REF 163TA9924 (steel)
HYUNDAI R36N-7				
REF 163TA9330 (for rubber and steel tracks) (Ø flange = 113,00 mm) (Ø body = 95,00 mm)	REF 163TA9332 (assembly) (for rubber and steel tracks) (Ø body = 75,00 mm)	REF 163TA9941 (for rubber and steel tracks) (number of teeth = 21) (number of holes = 12)	REF 163TA9331 (front, with bracket assembly) (for rubber and steel tracks) (Ø = 311,00 mm)	REF 163TA9913 (rubber) (300 x 52,5 x 84) REF 163TA9929 (steel)
HYUNDAI R55-3				
<i>S/N: up to - 0612</i>				
		REF 163TA9936 (for rubber tracks)		
<i>S/N: up to - 0697</i>				
REF 144TA7919 (for steel tracks)	REF 144TA7756 (assembly) (for steel tracks)	REF 163TA9936 (for steel tracks)	REF 144TA7583 (front, with bracket assembly) (for steel tracks) (Ø = 384,00 mm)	
<i>S/N: 0613 - 0919</i>				
REF 163TA9951 (for steel tracks)		REF 143TA9090 (for rubber tracks)		
<i>S/N: 0698 - 0919</i>				
REF 163TA9951 (for steel tracks)	REF 144TA7757 (assembly) (for steel tracks)	REF 143TA9090 (for steel tracks)	REF 144TA7584 (front, with bracket assembly) (for steel tracks) (Ø = 384,00 mm)	
<i>S/N: 0920 - 1361</i>				
	REF 143TA8652 (assembly) (for steel tracks)	REF 143TA9088 (for rubber and steel tracks)	REF 144TA7585 (front, with bracket assembly) (for steel tracks) (Ø = 384,00 mm)	
<i>S/N: 0920 - 1714</i>				
REF 163TA9952 (for steel tracks)	REF 143TA8652 (assembly) (for steel tracks)	REF 143TA9088 (for rubber and steel tracks)		
<i>S/N: 1362 - and up</i>				
REF 143TA8652 (for steel tracks)			REF 144TA7582 (front, with bracket assembly) (for steel tracks) (Ø = 384,00 mm)	

TRACKS & UNDERCARRIAGE PARTS







used for HYUNDAI

used for HYUNDAI				
TRACK ROLLER	TOP ROLLER	SPROCKET	IDLER	TRACK
				
HYUNDAI R55-7				
<i>S/N: up to - 1798</i>				
				REF 163TA9302 (rubber) (400 x 72,5 x 76)
<i>S/N: up to - 2789</i>				
REF 163TA9305 (for rubber and steel tracks)				
<i>S/N: up to - 2997</i>				
				REF 163TA9325 (steel)
<i>S/N: up to - 3289</i>				
		REF 163TA9297 (for rubber and steel tracks)	REF 163TA9299 (front, with bracket assembly) (for rubber tracks) REF 164TA1002 (front, with bracket assembly) (for steel tracks) (Ø = 384,00 mm)	
<i>S/N: 1799 - 2823</i>				
				REF 163TA9327 (rubber) (400 x 72,5 x 76)
<i>S/N: 2790 - and up</i>				
REF 163TA9306 (for rubber and steel tracks)				
<i>S/N: 2824 - 3236</i>				
				REF 163TA9301 (rubber) (400 x 72,5 x 76)
<i>S/N: 2998 - 3289</i>				
				REF 163TA9326 (steel) (width = 400,00 mm)
<i>S/N: 3237 - 3295</i>				
				REF 163TA9302 (rubber) (400 x 72,5 x 76)
<i>S/N: 3290 - 3820</i>				
			REF 163TA9300 (front, with bracket assembly) (for rubber tracks)	
<i>S/N: 3290 - and up</i>				
		REF 163TA9298 (for rubber and steel tracks)	REF 163TA9294 (front, with bracket assembly) (for steel tracks)	REF 163TA9329 (steel) (width = 400,00 mm)
<i>S/N: 3296 - and up</i>				
				REF 163TA9899 (rubber) (400 x 72,5 x 76)
<i>S/N: 3821 - and up</i>				
			REF 163TA9328 (front, with bracket assembly) (for rubber tracks)	
HYUNDAI R55-7A				
<i>S/N: up to - 0026</i>				
REF 163TA9306 (for steel tracks)				
				REF 163TA9301 (rubber) (400 x 72,5 x 76)

TRACKS & UNDERCARRIAGE PARTS







used for HYUNDAI

used for HYUNDAI				
TRACK ROLLER	TOP ROLLER	SPROCKET	IDLER	TRACK
				
<i>S/N: up to - 0150</i>				
REF 163TA9306 (for steel tracks)		REF 163TA9943 (for steel tracks) REF 163TA9297 (for rubber tracks)	REF 164TA1002 (front, with bracket assembly) (for steel tracks) (Ø = 384,00 mm) REF 163TA9299 (front, with bracket assembly) (for rubber tracks)	REF 163TA9326 (steel) (width = 400,00 mm)
<i>S/N: up to - 0372</i>				
REF 163TA9972 (for rubber tracks)				
REF 163TA9306 (for steel tracks)				
<i>S/N: 0027 - 0163</i>				
REF 163TA9306 (for steel tracks)				REF 163TA9302 (rubber) (400 x 72,5 x 76)
<i>S/N: 0151 - 0220</i>				
REF 163TA9306 (for steel tracks)				REF 163TA9329 (steel) (width = 400,00 mm)
<i>S/N: 0151 - and up</i>				
REF 163TA9306 (for steel tracks)		REF 163TA9298 (for rubber and steel tracks)	REF 163TA9294 (front, with bracket assembly) (for steel tracks) REF 163TA9300 (front, with bracket assembly) (for rubber tracks)	
<i>S/N: 0164 - and up</i>				
REF 163TA9306 (for steel tracks)				REF 163TA9899 (rubber) (400 x 72,5 x 76)
<i>S/N: 0373 - and up</i>				
REF 163TA9973 (for rubber tracks)				
REF 163TA9306 (for steel tracks)				
HYUNDAI R55-9				
<i>S/N: up to - 3319</i>				
		REF 163TA9935 (for rubber tracks)	REF 163TA9300 (front, with bracket assembly) (for rubber tracks)	REF 163TA9899 (rubber) (400 x 72,5 x 76)
<i>S/N: 1001 - 3070</i>				
REF 163TA9950 (for rubber tracks)		REF 163TA9935 (for rubber tracks)		REF 163TA9899 (rubber) (400 x 72,5 x 76)
<i>S/N: 3071 - 3382</i>				
REF 163TA9948 (for rubber tracks)		REF 163TA9935 (for rubber tracks)		REF 163TA9899 (rubber) (400 x 72,5 x 76)
<i>S/N: 3320 - and up</i>				
		REF 163TA9935 (for rubber tracks)	REF 163TA9328 (front, with bracket assembly) (for rubber tracks)	REF 163TA9899 (rubber) (400 x 72,5 x 76)
<i>S/N: 3383 - and up</i>				
REF 163TA9949 (for rubber tracks)		REF 163TA9935 (for rubber tracks)		REF 163TA9899 (rubber) (400 x 72,5 x 76)

TRACKS & UNDERCARRIAGE PARTS



used for HYUNDAI

used for HYUNDAI				
TRACK ROLLER	TOP ROLLER	SPROCKET	IDLER	TRACK
				
HYUNDAI R55-9A				
<i>S/N: up to - 0003</i>				
REF 163TA9947 (for steel tracks)	REF 163TA9978 (assembly) (for steel tracks)	REF 163TA9935 (for steel tracks)	REF 163TA9300 (front, with bracket assembly) (for rubber tracks) REF 163TA9294 (front, with bracket assembly) (for steel tracks)	REF 163TA9899 (rubber) (400 x 72,5 x 76)
<i>S/N: up to - 0008</i>				
REF 163TA9948 (for rubber tracks)	REF 163TA9978 (assembly) (for steel tracks)	REF 163TA9935 (for steel tracks)	REF 163TA9294 (front, with bracket assembly) (for steel tracks)	REF 163TA9899 (rubber) (400 x 72,5 x 76)
REF 163TA9947 (for steel tracks)				
<i>S/N: up to - 0011</i>				
REF 163TA9947 (for steel tracks)	REF 163TA9978 (assembly) (for steel tracks)	REF 163TA9935 (for steel tracks)	REF 163TA9294 (front, with bracket assembly) (for steel tracks)	REF 163TA9919 (steel) (width = 380,00 mm) REF 163TA9899 (rubber) (400 x 72,5 x 76)
<i>S/N: 0004 - and up</i>				
REF 163TA9947 (for steel tracks)	REF 163TA9978 (assembly) (for steel tracks)	REF 163TA9935 (for steel tracks)	REF 163TA9328 (front, with bracket assembly) (for rubber tracks) REF 163TA9294 (front, with bracket assembly) (for steel tracks)	REF 163TA9899 (rubber) (400 x 72,5 x 76)
<i>S/N: 0009 - 0011</i>				
REF 163TA9947 (for steel tracks)	REF 163TA9978 (assembly) (for steel tracks)	REF 163TA9935 (for steel tracks)	REF 163TA9294 (front, with bracket assembly) (for steel tracks)	REF 163TA9917 (steel) (width = 450,00 mm) REF 163TA9899 (rubber) (400 x 72,5 x 76)
<i>S/N: 0009 - and up</i>				
REF 163TA9949 (for rubber tracks)	REF 163TA9978 (assembly) (for steel tracks)	REF 163TA9935 (for steel tracks)	REF 163TA9294 (front, with bracket assembly) (for steel tracks)	REF 163TA9899 (rubber) (400 x 72,5 x 76)
REF 163TA9947 (for steel tracks)				
<i>S/N: 0012 - and up</i>				
REF 163TA9947 (for steel tracks)	REF 163TA9978 (assembly) (for steel tracks)	REF 163TA9935 (for steel tracks)	REF 163TA9294 (front, with bracket assembly) (for steel tracks)	REF 163TA9920 (steel) (width = 380,00 mm) REF 163TA9918 (steel) (width = 450,00 mm) REF 163TA9899 (rubber) (400 x 72,5 x 76)
HYUNDAI R60-9S				
<i>S/N: up to - 5006</i>				
REF 163TA9950 (for rubber tracks)	REF 163TA9978 (assembly) (for steel tracks)	REF 163TA9935 (for rubber and steel tracks)	REF 163TA9294 (front, with bracket assembly) (for steel tracks)	REF 163TA9899 (rubber) (400 x 72,5 x 76)
REF 163TA9947 (for steel tracks)				

TRACKS & UNDERCARRIAGE PARTS







used for HYUNDAI

used for HYUNDAI				
TRACK ROLLER	TOP ROLLER	SPROCKET	IDLER	TRACK
				
<i>S/N: up to - 5089</i>				
REF 163TA9947 (for steel tracks)	REF 163TA9978 (assembly) (for steel tracks)	REF 163TA9935 (for rubber and steel tracks)	REF 163TA9300 (front, with bracket assembly) (for rubber tracks) REF 163TA9294 (front, with bracket assembly) (for steel tracks)	REF 163TA9899 (rubber) (400 x 72,5 x 76)
<i>S/N: up to - 5183</i>				
REF 163TA9947 (for steel tracks)	REF 163TA9978 (assembly) (for steel tracks)	REF 163TA9935 (for rubber and steel tracks)	REF 163TA9294 (front, with bracket assembly) (for steel tracks)	REF 163TA9919 (steel) (width = 380,00 mm) REF 163TA9899 (rubber) (400 x 72,5 x 76)
<i>S/N: 5007 - 5139</i>				
REF 163TA9948 (for rubber tracks) REF 163TA9947 (for steel tracks)	REF 163TA9978 (assembly) (for steel tracks)	REF 163TA9935 (for rubber and steel tracks)	REF 163TA9294 (front, with bracket assembly) (for steel tracks)	REF 163TA9899 (rubber) (400 x 72,5 x 76)
<i>S/N: 5021 - 5183</i>				
REF 163TA9947 (for steel tracks)	REF 163TA9978 (assembly) (for steel tracks)	REF 163TA9935 (for rubber and steel tracks)	REF 163TA9294 (front, with bracket assembly) (for steel tracks)	REF 163TA9917 (steel) (width = 450,00 mm) REF 163TA9899 (rubber) (400 x 72,5 x 76)
<i>S/N: 5090 - and up</i>				
REF 163TA9947 (for steel tracks)	REF 163TA9978 (assembly) (for steel tracks)	REF 163TA9935 (for rubber and steel tracks)	REF 163TA9328 (front, with bracket assembly) (for rubber tracks) REF 163TA9294 (front, with bracket assembly) (for steel tracks)	REF 163TA9899 (rubber) (400 x 72,5 x 76)
<i>S/N: 5132 - 5183</i>				
REF 163TA9947 (for steel tracks)	REF 163TA9978 (assembly) (for steel tracks)	REF 163TA9935 (for rubber and steel tracks)	REF 163TA9294 (front, with bracket assembly) (for steel tracks)	REF 163TA9921 (steel) (width = 400,00 mm) REF 163TA9899 (rubber) (400 x 72,5 x 76)
<i>S/N: 5140 - and up</i>				
REF 163TA9949 (for rubber tracks) REF 163TA9947 (for steel tracks)	REF 163TA9978 (assembly) (for steel tracks)	REF 163TA9935 (for rubber and steel tracks)	REF 163TA9294 (front, with bracket assembly) (for steel tracks)	REF 163TA9899 (rubber) (400 x 72,5 x 76)
<i>S/N: 5184 - and up</i>				
REF 163TA9947 (for steel tracks)	REF 163TA9978 (assembly) (for steel tracks)	REF 163TA9935 (for rubber and steel tracks)	REF 163TA9294 (front, with bracket assembly) (for steel tracks)	REF 163TA9920 (steel) (width = 380,00 mm) REF 163TA9918 (steel) (width = 450,00 mm) REF 163TA9922 (steel) (width = 400,00 mm) REF 163TA9899 (rubber) (400 x 72,5 x 76)

TRACKS & UNDERCARRIAGE PARTS







used for HYUNDAI

used for HYUNDAI				
TRACK ROLLER	TOP ROLLER	SPROCKET	IDLER	TRACK
				
HYUNDAI R60CR-9				
<i>S/N: up to - 0020</i>				
REF 163TA9947 (for steel tracks)		REF 163TA9935 (for rubber and steel tracks)	REF 163TA9294 (front, with bracket assembly) (for steel tracks)	REF 163TA9923 (steel) (width = 380,00 mm) REF 163TA9899 (rubber) (400 x 72,5 x 76)
<i>S/N: up to - 0266</i>				
REF 163TA9950 (for rubber tracks)		REF 163TA9935 (for rubber and steel tracks)	REF 163TA9294 (front, with bracket assembly) (for steel tracks)	REF 163TA9899 (rubber) (400 x 72,5 x 76)
REF 163TA9947 (for steel tracks)				
<i>S/N: up to - 0740</i>				
REF 163TA9947 (for steel tracks)		REF 163TA9935 (for rubber and steel tracks)	REF 163TA9300 (front, with bracket assembly) (for rubber tracks) REF 163TA9294 (front, with bracket assembly) (for steel tracks)	REF 163TA9899 (rubber) (400 x 72,5 x 76)
<i>S/N: 0021 - 0913</i>				
REF 163TA9947 (for steel tracks)		REF 163TA9935 (for rubber and steel tracks)	REF 163TA9294 (front, with bracket assembly) (for steel tracks)	REF 163TA9919 (steel) (width = 380,00 mm) REF 163TA9899 (rubber) (400 x 72,5 x 76)
<i>S/N: 0267 - 0844</i>				
REF 163TA9948 (for rubber tracks)		REF 163TA9935 (for rubber and steel tracks)	REF 163TA9294 (front, with bracket assembly) (for steel tracks)	REF 163TA9899 (rubber) (400 x 72,5 x 76)
REF 163TA9947 (for steel tracks)				
<i>S/N: 0741 - and up</i>				
REF 163TA9947 (for steel tracks)		REF 163TA9935 (for rubber and steel tracks)	REF 163TA9328 (front, with bracket assembly) (for rubber tracks) REF 163TA9294 (front, with bracket assembly) (for steel tracks)	REF 163TA9899 (rubber) (400 x 72,5 x 76)
<i>S/N: 0834 - 0913</i>				
REF 163TA9947 (for steel tracks)		REF 163TA9935 (for rubber and steel tracks)	REF 163TA9294 (front, with bracket assembly) (for steel tracks)	REF 163TA9917 (steel) (width = 450,00 mm) REF 163TA9899 (rubber) (400 x 72,5 x 76)
<i>S/N: 0845 - and up</i>				
REF 163TA9949 (for rubber tracks)		REF 163TA9935 (for rubber and steel tracks)	REF 163TA9294 (front, with bracket assembly) (for steel tracks)	REF 163TA9899 (rubber) (400 x 72,5 x 76)
REF 163TA9947 (for steel tracks)				





TRACKS & UNDERCARRIAGE PARTS



used for HYUNDAI

used for HYUNDAI				
TRACK ROLLER	TOP ROLLER	SPROCKET	IDLER	TRACK
				
<i>S/N: 0914 - and up</i>				
REF 163TA9947 (for steel tracks)		REF 163TA9935 (for rubber and steel tracks)	REF 163TA9294 (front, with bracket assembly) (for steel tracks)	REF 163TA9920 (steel) (width = 380,00 mm) REF 163TA9918 (steel) (width = 450,00 mm) REF 163TA9899 (rubber) (400 x 72,5 x 76)
HYUNDAI R60CR-9A				
<i>S/N: up to - 0002</i>				
REF 163TA9947 (for steel tracks)	REF 163TA9978 (assembly) (for steel tracks)	REF 163TA9935 (for rubber and steel tracks)	REF 163TA9300 (front, with bracket assembly) (for rubber tracks) REF 163TA9294 (front, with bracket assembly) (for steel tracks)	REF 163TA9899 (rubber) (400 x 72,5 x 76)
<i>S/N: up to - 0014</i>				
REF 163TA9948 (for rubber tracks) REF 163TA9947 (for steel tracks)	REF 163TA9978 (assembly) (for steel tracks)	REF 163TA9935 (for rubber and steel tracks)	REF 163TA9294 (front, with bracket assembly) (for steel tracks)	REF 163TA9899 (rubber) (400 x 72,5 x 76)
<i>S/N: up to - 0030</i>				
REF 163TA9947 (for steel tracks)	REF 163TA9978 (assembly) (for steel tracks)	REF 163TA9935 (for rubber and steel tracks)	REF 163TA9294 (front, with bracket assembly) (for steel tracks)	REF 163TA9919 (steel) (width = 380,00 mm) REF 163TA9899 (rubber) (400 x 72,5 x 76)
<i>S/N: 0003 - and up</i>				
REF 163TA9947 (for steel tracks)	REF 163TA9978 (assembly) (for steel tracks)	REF 163TA9935 (for rubber and steel tracks)	REF 163TA9328 (front, with bracket assembly) (for rubber tracks) REF 163TA9294 (front, with bracket assembly) (for steel tracks)	REF 163TA9899 (rubber) (400 x 72,5 x 76)
<i>S/N: 0014 - 0030</i>				
REF 163TA9947 (for steel tracks)	REF 163TA9978 (assembly) (for steel tracks)	REF 163TA9935 (for rubber and steel tracks)	REF 163TA9294 (front, with bracket assembly) (for steel tracks)	REF 163TA9917 (steel) (width = 450,00 mm) REF 163TA9899 (rubber) (400 x 72,5 x 76)
<i>S/N: 0015 - and up</i>				
REF 163TA9949 (for rubber tracks) REF 163TA9947 (for steel tracks)	REF 163TA9978 (assembly) (for steel tracks)	REF 163TA9935 (for rubber and steel tracks)	REF 163TA9294 (front, with bracket assembly) (for steel tracks)	REF 163TA9899 (rubber) (400 x 72,5 x 76)
<i>S/N: 0031 - and up</i>				
REF 163TA9947 (for steel tracks)	REF 163TA9978 (assembly) (for steel tracks)	REF 163TA9935 (for rubber and steel tracks)	REF 163TA9294 (front, with bracket assembly) (for steel tracks)	REF 163TA9920 (steel) (width = 380,00 mm) REF 163TA9918 (steel) (width = 450,00 mm)



used for HYUNDAI				
TRACK ROLLER	TOP ROLLER	SPROCKET	IDLER	TRACK
				
				REF 163TA9899 (rubber) (400 x 72,5 x 76)
HYUNDAI R75-7				
<i>S/N: up to - 0370</i>				
REF 163TA9974 (for steel tracks) REF 163TA9975 (for rubber tracks) (∅ flange = 149,00 mm) (∅ body = 125,00 mm)		REF 163TA9944 (for rubber and steel tracks)	REF 164TA1003 (front, with bracket assembly) (for rubber and steel tracks)	REF 163TA9932 (steel) (width = 400,00 mm) REF 163TA9933 (steel) (width = 600,00 mm) REF 163TA9914 (rubber) (450 x 71 x 86) REF 163TA9931 (steel)
<i>S/N: 0371 - and up</i>				
REF 163TA9974 (for steel tracks) REF 163TA9975 (for rubber tracks) (∅ flange = 149,00 mm) (∅ body = 125,00 mm)		REF 163TA9944 (for rubber and steel tracks)	REF 164TA1003 (front, with bracket assembly) (for rubber and steel tracks)	REF 164TA2048 (steel) (width = 400,00 mm) REF 163TA9934 (steel) (width = 600,00 mm) REF 163TA9914 (rubber) (450 x 71 x 86) REF 163TA9931 (steel)
HYUNDAI R80-7				
<i>S/N: up to - 0063</i>				
REF 143TA8655 (for steel tracks)	REF 143TA8921 (assembly) (for rubber and steel tracks)	REF 163TA9945 (for rubber and steel tracks)	REF 143TA9360 (front, with bracket assembly) (for steel tracks)	
<i>S/N: 0021 - 1030</i>				
REF 163TA9976 (for rubber tracks) REF 143TA8655 (for steel tracks)	REF 143TA8921 (assembly) (for rubber and steel tracks)		REF 164TA1539 (front, with bracket assembly) (for rubber tracks) REF 143TA9360 (front, with bracket assembly) (for steel tracks)	
<i>S/N: 0021 - 1229</i>				
REF 143TA8655 (for steel tracks)	REF 143TA8921 (assembly) (for rubber and steel tracks)		REF 143TA9360 (front, with bracket assembly) (for steel tracks)	REF 163TA9915 (rubber) (450 x 83,5 x 72)
<i>S/N: 0064 - and up</i>				
REF 143TA8655 (for steel tracks)	REF 143TA8921 (assembly) (for rubber and steel tracks)	REF 163TA9946 (for rubber and steel tracks) (number of teeth = 21) (number of holes = 12)	REF 143TA9360 (front, with bracket assembly) (for steel tracks)	
<i>S/N: 1031 - and up</i>				
REF 163TA9977 (for rubber tracks) REF 143TA8655 (for steel tracks)	REF 143TA8921 (assembly) (for rubber and steel tracks)		REF 164TA1540 (front, with bracket assembly) (for rubber tracks) REF 143TA9360 (front, with bracket assembly) (for steel tracks)	





TRACKS & UNDERCARRIAGE PARTS



used for HYUNDAI

used for HYUNDAI				
TRACK ROLLER	TOP ROLLER	SPROCKET	IDLER	TRACK
				
<i>S/N: 1230 - and up</i>				
REF 143TA8655 (for steel tracks)	REF 143TA8921 (assembly) (for rubber and steel tracks)		REF 143TA9360 (front, with bracket assembly) (for steel tracks)	REF 163TA9916 (rubber) (450 x 83,5 x 72)
HYUNDAI R80-7A				
<i>S/N: up to - 0032</i>				
	REF 143TA8921 (assembly) (for rubber tracks)	REF 163TA9946 (for rubber tracks) (number of teeth = 21) (number of holes = 12)	REF 164TA1539 (front, with bracket assembly) (for rubber tracks)	REF 163TA9915 (rubber) (450 x 83,5 x 72)
<i>S/N: up to - 0107</i>				
REF 163TA9976 (for rubber tracks)	REF 143TA8921 (assembly) (for rubber tracks)	REF 163TA9946 (for rubber tracks) (number of teeth = 21) (number of holes = 12)		REF 163TA9915 (rubber) (450 x 83,5 x 72)
<i>S/N: 0033 - and up</i>				
	REF 143TA8921 (assembly) (for rubber tracks)	REF 163TA9946 (for rubber tracks) (number of teeth = 21) (number of holes = 12)	REF 164TA1540 (front, with bracket assembly) (for rubber tracks)	REF 163TA9915 (rubber) (450 x 83,5 x 72)
<i>S/N: 0108 - and up</i>				
REF 163TA9977 (for rubber tracks)	REF 143TA8921 (assembly) (for rubber tracks)	REF 163TA9946 (for rubber tracks) (number of teeth = 21) (number of holes = 12)		REF 163TA9915 (rubber) (450 x 83,5 x 72)
HYUNDAI R80CR-9				
<i>S/N: up to - 0268</i>				
REF 163TA9965 (for rubber tracks)	REF 163TA9982 (assembly) (for rubber and steel tracks)	REF 163TA9938 (for rubber and steel tracks) (number of teeth = 21) (number of holes = 12)	REF 163TA9995 (front, with bracket assembly) (for steel tracks)	REF 163TA9925 (steel) (width = 450,00 mm)
REF 163TA9964 (for steel tracks)				REF 163TA9926 (steel) (width = 600,00 mm)
<i>S/N: up to - 0661</i>				
REF 163TA9964 (for steel tracks)	REF 163TA9982 (assembly) (for rubber and steel tracks)	REF 163TA9938 (for rubber and steel tracks) (number of teeth = 21) (number of holes = 12)	REF 163TA9995 (front, with bracket assembly) (for steel tracks)	REF 163TA9907 (rubber) (450 x 83,5 x 74)
				REF 163TA9925 (steel) (width = 450,00 mm)
				REF 163TA9926 (steel) (width = 600,00 mm)
<i>S/N: 0269 - and up</i>				
REF 163TA9966 (for rubber tracks)	REF 163TA9982 (assembly) (for rubber and steel tracks)	REF 163TA9938 (for rubber and steel tracks) (number of teeth = 21) (number of holes = 12)	REF 163TA9995 (front, with bracket assembly) (for steel tracks)	REF 163TA9925 (steel) (width = 450,00 mm)
REF 163TA9964 (for steel tracks)				REF 163TA9926 (steel) (width = 600,00 mm)
<i>S/N: 0662 - and up</i>				
REF 163TA9964 (for steel tracks)	REF 163TA9982 (assembly) (for rubber and steel tracks)	REF 163TA9938 (for rubber and steel tracks) (number of teeth = 21) (number of holes = 12)	REF 163TA9995 (front, with bracket assembly) (for steel tracks)	REF 163TA9908 (rubber) (450 x 83,5 x 74)



used for HYUNDAI				
TRACK ROLLER	TOP ROLLER	SPROCKET	IDLER	TRACK
				
			REF 163TA9996 (front, with bracket assembly) (for rubber tracks)	REF 163TA9925 (steel) (width = 450,00 mm)
HYUNDAI R80CR-9A				
<i>S/N: 0269 - and up</i>				
REF 163TA9966 (for rubber tracks)	REF 163TA9982 (assembly) (for rubber and steel tracks)	REF 163TA9938 (for rubber and steel tracks) (number of teeth = 21) (number of holes = 12)	REF 163TA9995 (front, with bracket assembly) (for steel tracks)	REF 163TA9908 (rubber) (450 x 83,5 x 74)
REF 163TA9964 (for steel tracks)			REF 163TA9996 (front, with bracket assembly) (for rubber tracks)	REF 163TA9925 (steel) (width = 450,00 mm)
				REF 163TA9926 (steel) (width = 600,00 mm)



USED FOR
IHI



used for IHI

used for IHI				
TRACK ROLLER	TOP ROLLER	SPROCKET	IDLER	TRACK
				
IHI 10F				
REF 144TA8707 (for rubber tracks) (Ø flange = 129,50 mm) (Ø body = 68,00 mm)				
IHI 12F				
REF 144TA8707 (for rubber tracks) (Ø flange = 129,50 mm) (Ø body = 68,00 mm)				
IHI 12G				
REF 144TA8707 (for rubber tracks) (Ø flange = 129,50 mm) (Ø body = 68,00 mm)				
IHI 12JX				
REF 164TA2991 (for rubber tracks)	REF 164TA2972 (guide) (for rubber tracks) (skid type)	REF 143TA9092 (for rubber tracks)	REF 164TA2992 (front, with bracket assembly) (for rubber tracks)	REF 164TA2953 (rubber) (230 x 72 x 47)
IHI 14G				
REF 144TA8707 (for rubber tracks) (Ø flange = 129,50 mm) (Ø body = 68,00 mm)				
IHI 14NXT				
<i>S/N: EM200001 - and up</i>				
REF 164TA3005 (for steel tracks)	REF 164TA2976 (guide) (for rubber and steel tracks) (plate type)	REF 143TA9095 (for rubber and steel tracks) (number of teeth = 21) (number of holes = 9)	REF 164TA3003 (front, with bracket assembly) (for steel tracks)	REF 164TA2951 (rubber) (230 x 96 x 32)
REF 164TA3001 (for rubber tracks) (Ø flange = 120,00 mm) (Ø body = 80,00 mm)			REF 164TA3002 (front, with bracket assembly) (for rubber tracks) (Ø = 270,00 mm)	
IHI 15J				
REF 164TA3001 (for rubber and steel tracks) (Ø flange = 120,00 mm) (Ø body = 80,00 mm)	REF 164TA2975 (guide) (for rubber and steel tracks) (plate type)	REF 143TA9095 (for rubber and steel tracks) (number of teeth = 21) (number of holes = 9)	REF 164TA2989 (front, with bracket assembly) (for steel tracks)	REF 164TA2951 (rubber) (230 x 96 x 32)
			REF 164TA2988 (front, with bracket assembly) (for rubber tracks)	
IHI 15NX				
REF 164TA3006 (for steel tracks)		REF 164TA2996 (for rubber tracks)	REF 164TA3008 (front, with bracket assembly) (for steel tracks)	REF 164TA2952 (rubber) (230 x 96 x 35)
REF 143TA8659 (for rubber tracks) (Ø flange = 120,00 mm) (Ø body = 80,00 mm)			REF 164TA3007 (front, with bracket assembly) (for rubber tracks)	
IHI 15VXT				
REF 163TA9406 (for rubber tracks) (Ø flange = 120,00 mm) (Ø body = 80,00 mm)		REF 143TA9093 (for rubber tracks)	REF 163TA9346 (front, with bracket assembly) (for rubber tracks)	REF 164TA3068 (rubber) (230 x 96 x 35)
IHI 16N-Light				
REF 163TA9407 (for rubber tracks) (Ø flange = 120,00 mm) (Ø body = 80,00 mm)		REF 143TA9093 (for rubber tracks)	REF 163TA9347 (front, with bracket assembly) (for rubber tracks) (Ø = 270,00 mm)	REF 143TA9750 (rubber) (230 x 96 x 32)



used for IHI				
TRACK ROLLER	TOP ROLLER	SPROCKET	IDLER	TRACK
				
IHI 16NXT				
REF 164TA3001 (for rubber tracks) (Ø flange = 120,00 mm) (Ø body = 80,00 mm)	REF 164TA2976 (guide) (for rubber and steel tracks) (plate type)	REF 143TA9095 (for rubber and steel tracks) (number of teeth = 21) (number of holes = 9)	REF 164TA3002 (front, with bracket assembly) (for rubber tracks) (Ø = 270,00 mm) REF 164TA3003 (front, with bracket assembly) (for steel tracks)	REF 164TA2952 (rubber) (230 x 96 x 35)
REF 164TA3005 (for steel tracks)				
IHI 16VXE				
REF 163TA9409 (for rubber tracks) (Ø flange = 120,00 mm) (Ø body = 80,00 mm)		REF 143TA9093 (for rubber tracks)	REF 163TA9349 (front, with bracket assembly) (for rubber tracks)	REF 164TA3068 (rubber) (230 x 96 x 35)
IHI 16VXT				
REF 163TA9410 (for rubber tracks) (Ø flange = 120,00 mm) (Ø body = 80,00 mm)		REF 143TA9093 (for rubber tracks)	REF 163TA9350 (front, with bracket assembly) (for rubber tracks)	REF 164TA3068 (rubber) (230 x 96 x 35)
IHI 17JE				
REF 164TA2982 (for rubber and steel tracks) (Ø flange = 120,00 mm) (Ø body = 80,00 mm)	REF 164TA2975 (assembly) (for rubber and steel tracks)	REF 143TA9095 (for rubber and steel tracks) (number of teeth = 21) (number of holes = 9)	REF 164TA2988 (front, with bracket assembly) (for rubber tracks) REF 164TA2989 (front, with bracket assembly) (for steel tracks)	REF 164TA2951 (rubber) (230 x 96 x 32)
IHI 17NE				
			REF 163TA9351 (front, with bracket assembly) (for rubber tracks)	REF 143TA9750 (rubber) (230 x 96 x 32)
IHI 17VXE				
<i>S/N: EG170001 - and up</i>				
REF 164TA3001 (for rubber tracks) (Ø flange = 120,00 mm) (Ø body = 80,00 mm)	REF 164TA2976 (guide) (for rubber and steel tracks) (plate type)	REF 143TA9095 (for rubber and steel tracks) (number of teeth = 21) (number of holes = 9)	REF 164TA3003 (front, with bracket assembly) (for steel tracks) REF 164TA3002 (front, with bracket assembly) (for rubber tracks) (Ø = 270,00 mm)	REF 164TA2952 (rubber) (230 x 96 x 35)
REF 164TA3005 (for steel tracks)				
IHI 17VXT				
<i>S/N: EF170001 - and up</i>				
REF 163TA9412 (for rubber tracks) (Ø flange = 120,00 mm) (Ø body = 80,00 mm)		REF 143TA9093 (for rubber tracks)	REF 163TA9353 (front, with bracket assembly) (for rubber tracks)	REF 164TA3068 (rubber) (230 x 96 x 35)
IHI 18J				
REF 164TA2982 (for rubber and steel tracks) (Ø flange = 120,00 mm) (Ø body = 80,00 mm)	REF 164TA2975 (guide) (for rubber and steel tracks) (plate type)	REF 143TA9095 (for rubber and steel tracks) (number of teeth = 21) (number of holes = 9)	REF 164TA2988 (front, with bracket assembly) (for rubber tracks) REF 164TA2989 (front, with bracket assembly) (for steel tracks)	REF 164TA2952 (rubber) (230 x 96 x 35)

TRACKS & UNDERCARRIAGE PARTS



used for IHI

used for IHI				
TRACK ROLLER	TOP ROLLER	SPROCKET	IDLER	TRACK
				
IHI 18N			REF 163TA9355 (front, with bracket assembly) (for rubber tracks)	REF 164TA3068 (rubber) (230 x 96 x 35)
IHI 18NXT				
REF 164TA3001 (for rubber tracks) (Ø flange = 120,00 mm) (Ø body = 80,00 mm)	REF 164TA2976 (guide) (for rubber and steel tracks) (plate type)	REF 143TA9095 (for rubber and steel tracks) (number of teeth = 21) (number of holes = 9)	REF 164TA3003 (front, with bracket assembly) (for steel tracks)	REF 164TA2952 (rubber) (230 x 96 x 35)
REF 164TA3005 (for steel tracks)			REF 164TA3002 (front, with bracket assembly) (for rubber tracks) (Ø = 270,00 mm)	
IHI 19VXT				
<i>S/N: EH190001 - and up</i>				
REF 164TA3001 (for rubber tracks) (Ø flange = 120,00 mm) (Ø body = 80,00 mm)	REF 164TA2976 (guide) (for rubber and steel tracks) (plate type)	REF 143TA9095 (for rubber and steel tracks) (number of teeth = 21) (number of holes = 9)	REF 164TA3003 (front, with bracket assembly) (for steel tracks)	REF 164TA2952 (rubber) (230 x 96 x 35)
REF 164TA3005 (for steel tracks)			REF 164TA3002 (front, with bracket assembly) (for rubber tracks) (Ø = 270,00 mm)	
IHI 20JX				
REF 143TA8659 (for rubber tracks) (Ø flange = 120,00 mm) (Ø body = 80,00 mm)	REF 164TA2976 (guide) (for rubber tracks) (plate type)	REF 143TA9094 (for rubber tracks)	REF 143TA9366 (front, with bracket assembly) (for rubber tracks)	REF 164TA2954 (rubber) (260 x 96 x 40)
IHI 20NX2				
REF 143TA8659 (for rubber tracks) (Ø flange = 120,00 mm) (Ø body = 80,00 mm)	REF 164TA2976 (guide) (for rubber and steel tracks) (plate type)	REF 143TA9095 (for rubber and steel tracks) (number of teeth = 21) (number of holes = 9)	REF 164TA3007 (front, with bracket assembly) (for rubber tracks)	REF 164TA2954 (rubber) (260 x 96 x 40)
REF 164TA3006 (for steel tracks)			REF 164TA3008 (front, with bracket assembly) (for steel tracks)	
IHI 20VX				
REF 143TA8659 (for rubber tracks) (Ø flange = 120,00 mm) (Ø body = 80,00 mm)	REF 164TA2976 (guide) (for rubber and steel tracks) (plate type)	REF 143TA9095 (for rubber and steel tracks) (number of teeth = 21) (number of holes = 9)	REF 164TA3007 (front, with bracket assembly) (for rubber tracks)	REF 164TA2954 (rubber) (260 x 96 x 40)
REF 164TA3006 (for steel tracks)			REF 164TA3008 (front, with bracket assembly) (for steel tracks)	
IHI 20VX2				
REF 143TA8659 (for rubber tracks) (Ø flange = 120,00 mm) (Ø body = 80,00 mm)		REF 143TA9095 (for rubber tracks) (number of teeth = 21) (number of holes = 9)	REF 163TA9359 (front, with bracket assembly) (for rubber tracks)	REF 164TA2954 (rubber) (260 x 96 x 40)
IHI 20VX3				
REF 143TA8659 (for rubber tracks) (Ø flange = 120,00 mm) (Ø body = 80,00 mm)		REF 143TA9095 (for rubber tracks) (number of teeth = 21) (number of holes = 9)	REF 163TA9360 (front, with bracket assembly) (for rubber tracks)	REF 164TA2954 (rubber) (260 x 96 x 40)



used for IHI				
TRACK ROLLER	TOP ROLLER	SPROCKET	IDLER	TRACK
				
IHI 25J				
REF 164TA2987 (for rubber and steel tracks) (Ø flange = 113,00 mm) (Ø body = 90,00 mm)	REF 164TA2974 (guide) (for rubber tracks) (skid type) REF 164TA2973 (guide) (for steel tracks) (skid type)	REF 144TA7008 (for rubber and steel tracks) (number of teeth = 21) (number of holes = 9)	REF 144TA7040 (front, with bracket assembly) (for rubber tracks) (Ø = 330,00 mm) REF 164TA2984 (front, with bracket assembly) (for steel tracks)	REF 164TA2943 (rubber) (300 x 52,5w x 72)
IHI 25JX				
REF 164TA2987 (for rubber and steel tracks) (Ø flange = 113,00 mm) (Ø body = 90,00 mm)	REF 164TA2998 (assembly) (for rubber and steel tracks) (Ø body = 81,00 mm)	REF 164TA2971 (for rubber and steel tracks) (number of teeth = 21) (number of holes = 13)	REF 164TA2986 (front, with bracket assembly) (for rubber tracks) (Ø = 330,00 mm) REF 164TA2984 (front, with bracket assembly) (for steel tracks)	REF 164TA2944 (rubber) (300 x 52,5w x 76)
IHI 25NX				
REF 163TA9416 (for rubber tracks) (Ø flange = 114,00 mm) (Ø body = 90,00 mm)	REF 163TA9385 (assembly) (for rubber tracks) (Ø body = 81,00 mm)	REF 163TA9371 (for rubber tracks) (number of teeth = 23) (number of holes = 9)	REF 144TA6968 (front, with bracket assembly) (for rubber tracks) (Ø = 335,00 mm)	REF 143TA4266 (rubber) (300 x 52,5 x 78)
IHI 25NX2				
REF 164TA3000 (for rubber tracks) (Ø flange = 114,00 mm) (Ø body = 90,00 mm)	REF 164TA2998 (assembly) (for rubber tracks) (Ø body = 81,00 mm)	REF 164TA2995 (for rubber tracks) (number of teeth = 23) (number of holes = 9)	REF 144TA6968 (front, with bracket assembly) (for rubber tracks) (Ø = 335,00 mm)	REF 164TA2961 (rubber) (300 x 52,5w x 78)
IHI 25VX				
REF 164TA3000 (for rubber tracks) (Ø flange = 114,00 mm) (Ø body = 90,00 mm)	REF 164TA2998 (assembly) (for rubber tracks) (Ø body = 81,00 mm)	REF 164TA2995 (for rubber tracks) (number of teeth = 23) (number of holes = 9)	REF 144TA6968 (front, with bracket assembly) (for rubber tracks) (Ø = 335,00 mm)	REF 164TA2961 (rubber) (300 x 52,5w x 78)
IHI 27V4Light				
REF 164TA3000 (for rubber and steel tracks) (Ø flange = 114,00 mm) (Ø body = 90,00 mm)	REF 164TA2940 (assembly) (for rubber and steel tracks) (Ø body = 70,30 mm)	REF 164TA3012 (for rubber and steel tracks)	REF 144TA6968 (front, with bracket assembly) (for rubber and steel tracks) (Ø = 335,00 mm)	REF 164TA3010 (rubber) (250 x 52,5 x 78) REF 164TA3011 (rubber) (300 x 52,5 x 78)
IHI 28GX2				
REF 144TA8708 (for rubber tracks) (Ø flange = 113,00 mm) (Ø body = 90,00 mm)				
IHI 28J				
REF 164TA2987 (for rubber and steel tracks) (Ø flange = 113,00 mm) (Ø body = 90,00 mm)	REF 164TA2978 (assembly) (for rubber and steel tracks) (Ø body = 81,00 mm)	REF 164TA2969 (for rubber and steel tracks) (number of teeth = 21) (number of holes = 13)	REF 144TA7040 (front, with bracket assembly) (for rubber tracks) (Ø = 330,00 mm) REF 164TA2984 (front, with bracket assembly) (for steel tracks)	REF 164TA2944 (rubber) (300 x 52,5w x 76)
IHI 28N				
REF 164TA3000 (for rubber and steel tracks) (Ø flange = 114,00 mm) (Ø body = 90,00 mm)	REF 164TA2998 (assembly) (for rubber and steel tracks) (Ø body = 81,00 mm)	REF 164TA2995 (for rubber and steel tracks) (number of teeth = 23) (number of holes = 9)	REF 144TA6968 (front, with bracket assembly) (for rubber and steel tracks) (Ø = 335,00 mm)	REF 143TA4266 (rubber) (300 x 52,5 x 78)



used for IHI

used for IHI				
TRACK ROLLER	TOP ROLLER	SPROCKET	IDLER	TRACK
				
IHI 28N2				
REF 163TA9418 (for rubber tracks) (Ø flange = 114,00 mm) (Ø body = 90,00 mm)	REF 163TA9387 (assembly) (for rubber tracks) (Ø body = 81,00 mm)	REF 163TA9374 (for rubber tracks) (number of teeth = 23) (number of holes = 9)	REF 144TA6968 (front, with bracket assembly) (for rubber tracks) (Ø = 335,00 mm)	REF 143TA4266 (rubber) (300 x 52,5 x 78)
IHI 30J				
REF 164TA2987 (for rubber and steel tracks) (Ø flange = 113,00 mm) (Ø body = 90,00 mm)	REF 164TA2978 (assembly) (for rubber and steel tracks) (Ø body = 81,00 mm)	REF 144TA7008 (for rubber and steel tracks) (number of teeth = 21) (number of holes = 9)	REF 144TA7040 (front, with bracket assembly) (for rubber tracks) (Ø = 330,00 mm) REF 164TA2984 (front, with bracket assembly) (for steel tracks)	REF 164TA2945 (rubber) (300 x 52,5 x 80)
IHI 30JX				
<i>S/N: BK000001 - BK000133</i>				
REF 164TA2987 (for rubber and steel tracks) (Ø flange = 113,00 mm) (Ø body = 90,00 mm)	REF 164TA2998 (assembly) (for rubber and steel tracks) (Ø body = 81,00 mm)	REF 144TA7008 (for rubber and steel tracks) (number of teeth = 21) (number of holes = 9)	REF 164TA2986 (front, with bracket assembly) (for rubber tracks) (Ø = 330,00 mm) REF 164TA2984 (front, with bracket assembly) (for steel tracks)	REF 164TA2955 (rubber) (300 x 52,5w x 84)
<i>S/N: BK000134 - and up</i>				
REF 164TA2987 (for rubber and steel tracks) (Ø flange = 113,00 mm) (Ø body = 90,00 mm)	REF 164TA2998 (assembly) (for rubber and steel tracks) (Ø body = 81,00 mm)	REF 164TA2971 (for rubber and steel tracks) (number of teeth = 21) (number of holes = 13)	REF 164TA2986 (front, with bracket assembly) (for rubber tracks) (Ø = 330,00 mm) REF 164TA2984 (front, with bracket assembly) (for steel tracks)	REF 164TA2955 (rubber) (300 x 52,5w x 84)
IHI 30NX				
REF 164TA3000 (for rubber and steel tracks) (Ø flange = 114,00 mm) (Ø body = 90,00 mm)	REF 164TA2998 (assembly) (for rubber tracks) (Ø body = 81,00 mm)	REF 164TA2995 (for rubber tracks) (number of teeth = 23) (number of holes = 9)	REF 163TA9363 (front, with bracket assembly) (Ø = 330,00 mm) REF 164TA2986 (front, with bracket assembly) (for rubber and steel tracks) (Ø = 330,00 mm)	REF 164TA3057 (rubber) (300 x 52,5 x 84)
IHI 30NX2				
REF 163TA9421 (for rubber tracks) (Ø flange = 114,00 mm) (Ø body = 90,00 mm)	REF 163TA9389 (assembly) (for rubber tracks) (Ø body = 81,00 mm)	REF 163TA9377 (for steel tracks) (number of teeth = 21) (number of holes = 13)	REF 143TA9369 (front, with bracket assembly) (for rubber tracks) (Ø = 330,00 mm)	REF 164TA3057 (rubber) (300 x 52,5 x 84)
REF 163TA9422 (for steel tracks) (Ø flange = 114,00 mm) (Ø body = 90,00 mm)	REF 163TA9390 (assembly) (for steel tracks) (Ø body = 81,00 mm)	REF 163TA9376 (for rubber tracks) (number of teeth = 21) (number of holes = 13)	REF 163TA9363 (front, with bracket assembly) (for steel tracks) (Ø = 330,00 mm)	
IHI 30UJ				
	REF 163TA9391 (assembly) (for rubber tracks) (Ø body = 81,00 mm)			REF 164TA2945 (rubber) (300 x 52,5 x 80)







used for IHI				
TRACK ROLLER	TOP ROLLER	SPROCKET	IDLER	TRACK
				
IHI 30VX				
REF 164TA3000 (for rubber tracks) (Ø flange = 114,00 mm) (Ø body = 90,00 mm)	REF 164TA2998 (assembly) (for rubber tracks) (Ø body = 81,00 mm)	REF 164TA2971 (for rubber tracks) (number of teeth = 21) (number of holes = 13)	REF 144TA6968 (front, with bracket assembly) (for rubber tracks) (Ø = 335,00 mm)	REF 164TA2963 (rubber) (300 x 55 x 82)
IHI 32J				
REF 164TA2987 (for rubber and steel tracks) (Ø flange = 113,00 mm) (Ø body = 90,00 mm)	REF 164TA2978 (assembly) (for rubber and steel tracks) (Ø body = 81,00 mm)	REF 164TA2970 (for rubber and steel tracks) (number of teeth = 21) (number of holes = 9)	REF 144TA7040 (front, with bracket assembly) (for rubber tracks) (Ø = 330,00 mm) REF 164TA2984 (front, with bracket assembly) (for steel tracks)	REF 164TA2955 (rubber) (300 x 52,5w x 84)
IHI 35FX				
REF 163TA9423 (for rubber tracks) (Ø flange = 114,00 mm) (Ø body = 90,00 mm)		REF 144TA6970 (for rubber tracks) (number of teeth = 21) (number of holes = 9)		REF 143TA9693 (rubber) (300 x 52,5 x 90)
IHI 35J				
REF 164TA2987 (for rubber and steel tracks) (Ø flange = 113,00 mm) (Ø body = 90,00 mm)	REF 164TA2978 (assembly) (for rubber and steel tracks) (Ø body = 81,00 mm)	REF 144TA7008 (for rubber and steel tracks) (number of teeth = 21) (number of holes = 9)	REF 144TA7040 (front, with bracket assembly) (for rubber tracks) (Ø = 330,00 mm) REF 164TA2984 (front, with bracket assembly) (for steel tracks)	REF 164TA2946 (rubber) (300 x 52,5w x 84)
IHI 35JX				
REF 164TA2987 (for rubber and steel tracks) (Ø flange = 113,00 mm) (Ø body = 90,00 mm)	REF 164TA2998 (assembly) (for rubber and steel tracks) (Ø body = 81,00 mm)	REF 144TA7008 (for rubber and steel tracks) (number of teeth = 21) (number of holes = 9)	REF 164TA2986 (front, with bracket assembly) (for rubber tracks) (Ø = 330,00 mm) REF 164TA2984 (front, with bracket assembly) (for steel tracks)	REF 164TA2956 (rubber) (300 x 52,5w x 90)
IHI 35N				
REF 163TA9424 (for rubber tracks) (Ø flange = 113,00 mm) (Ø body = 90,00 mm)		REF 163TA9378 (for rubber tracks) (number of teeth = 23) (number of holes = 9)		REF 164TA3057 (rubber) (300 x 52,5 x 84)
IHI 35N2				
REF 163TA9425 (for rubber tracks) (Ø flange = 114,00 mm) (Ø body = 90,00 mm)				REF 143TA9693 (rubber) (300 x 52,5 x 90)
IHI 35NX				
REF 164TA3000 (for rubber tracks) (Ø flange = 114,00 mm) (Ø body = 90,00 mm)	REF 164TA2998 (assembly) (for rubber and steel tracks) (Ø body = 81,00 mm)	REF 144TA1878 (for rubber and steel tracks) (number of teeth = 23) (number of holes = 9)	REF 164TA2999 (front, with bracket assembly) (for rubber tracks) (Ø = 330,00 mm) REF 164TA2984 (front, with bracket assembly) (for steel tracks)	REF 164TA2962 (rubber) (300 x 52,5w x 90)



used for IHI				
TRACK ROLLER	TOP ROLLER	SPROCKET	IDLER	TRACK
				
IHI 35NX2				
REF 164TA3000 (for rubber and steel tracks) (Ø flange = 114,00 mm) (Ø body = 90,00 mm)	REF 164TA2998 (assembly) (for rubber and steel tracks) (Ø body = 81,00 mm)	REF 144TA1878 (for rubber and steel tracks) (number of teeth = 23) (number of holes = 9)	REF 143TA9369 (front, with bracket assembly) (for rubber tracks) (Ø = 330,00 mm) REF 164TA2984 (front, with bracket assembly) (for steel tracks)	REF 164TA2966 (rubber) (300 x 52,5w x 90)
IHI 35VX				
REF 164TA3000 (for rubber and steel tracks) (Ø flange = 114,00 mm) (Ø body = 90,00 mm)	REF 164TA2998 (assembly) (for rubber and steel tracks) (Ø body = 81,00 mm)	REF 144TA1878 (for rubber and steel tracks) (number of teeth = 23) (number of holes = 9)	REF 143TA9369 (front, with bracket assembly) (for rubber tracks) (Ø = 330,00 mm) REF 164TA2984 (front, with bracket assembly) (for steel tracks)	REF 164TA2966 (rubber) (300 x 52,5w x 90)
IHI 35VX2				
REF 164TA3000 (for rubber and steel tracks) (Ø flange = 114,00 mm) (Ø body = 90,00 mm)	REF 164TA2998 (assembly) (for rubber and steel tracks) (Ø body = 81,00 mm)	REF 144TA1878 (for rubber and steel tracks) (number of teeth = 23) (number of holes = 9)	REF 164TA2999 (front, with bracket assembly) (for rubber tracks) (Ø = 330,00 mm) REF 164TA2984 (front, with bracket assembly) (for steel tracks)	REF 164TA2966 (rubber) (300 x 52,5w x 90)
IHI 40F				
REF 163TA9429 (for rubber tracks) (Ø flange = 110,00 mm) (Ø body = 92,40 mm)				REF 164TA2947 (rubber) (400 x 72,5 x 72)
IHI 40G				
REF 163TA9429 (for rubber tracks) (Ø flange = 110,00 mm) (Ø body = 92,40 mm)				REF 164TA2947 (rubber) (400 x 72,5 x 72)
IHI 40G1				
REF 163TA9427 (for rubber tracks) (Ø flange = 110,00 mm) (Ø body = 92,40 mm)				REF 164TA2947 (rubber) (400 x 72,5 x 72)
IHI 40GX				
REF 163TA9428 (for rubber tracks) (Ø flange = 110,00 mm) (Ø body = 92,40 mm)				REF 164TA2947 (rubber) (400 x 72,5 x 72)
IHI 40GX2				
REF 163TA9428 (for rubber tracks) (Ø flange = 110,00 mm) (Ø body = 92,40 mm)				REF 164TA2947 (rubber) (400 x 72,5 x 72)
IHI 40GX3				
REF 163TA9429 (for rubber tracks) (Ø flange = 110,00 mm) (Ø body = 92,40 mm)				REF 164TA2947 (rubber) (400 x 72,5 x 72)
IHI 40J				
REF 163TA9429 (for rubber tracks) (Ø flange = 110,00 mm) (Ø body = 92,40 mm)				REF 164TA2947 (rubber) (400 x 72,5 x 72)



used for IHI				
TRACK ROLLER	TOP ROLLER	SPROCKET	IDLER	TRACK
				
IHI 40JX				
REF 163TA9430 (for rubber tracks) (Ø flange = 110,00 mm) (Ø body = 92,40 mm)	REF 163TA9393 (assembly) (for rubber tracks) (Ø body = 81,00 mm)	REF 143TA9096 (for rubber tracks)		REF 164TA2947 (rubber) (400 x 72,5 x 72)
IHI 40NX				
REF 164TA2958 (for rubber and steel tracks) (Ø flange = 132,00 mm) (Ø body = 110,00 mm)	REF 164TA2998 (assembly) (for rubber and steel tracks) (Ø body = 81,00 mm)	REF 164TA2994 (for rubber and steel tracks)	REF 164TA2985 (front, with bracket assembly) (for rubber and steel tracks) (Ø = 384,00 mm)	REF 164TA2957 (rubber) (400 x 72,5w x 72)
IHI 45J				
REF 164TA2948 (for rubber and steel tracks) (Ø flange = 110,00 mm) (Ø body = 92,40 mm)	REF 164TA2998 (assembly) (for rubber and steel tracks) (Ø body = 81,00 mm)	REF 143TA9096 (for rubber and steel tracks)	REF 164TA2983 (front, with bracket assembly) (for rubber tracks)	REF 164TA2947 (rubber) (400 x 72,5 x 72)
		REF 164TA2994 (for steel tracks) (type ab)	REF 164TA2979 (front, with bracket assembly) (for steel tracks)	
			REF 164TA2980 (front, with bracket assembly) (for steel tracks) (type ab)	
IHI 45NX				
REF 164TA2958 (for rubber and steel tracks) (Ø flange = 132,00 mm) (Ø body = 110,00 mm)	REF 164TA2998 (assembly) (for rubber and steeltracks) (Ø body = 81,00 mm)	REF 164TA2994 (for rubber and steeltracks)	REF 164TA2985 (front, with bracket assembly) (for rubber and steeltracks) (Ø = 384,00 mm)	REF 164TA2957 (rubber) (400 x 72,5w x 72)
IHI 50G				
REF 144TA6966 (for rubber tracks) (inner guide) (Ø flange = 132,00 mm) (Ø body = 110,00 mm)				
REF 163TA9427 (for rubber tracks) (outer guide) (Ø flange = 110,00 mm) (Ø body = 92,40 mm)				
IHI 50GX				
REF 144TA6966 (for rubber tracks) (inner guide) (Ø flange = 132,00 mm) (Ø body = 110,00 mm)				
REF 163TA9427 (for rubber tracks) (outer guide) (Ø flange = 110,00 mm) (Ø body = 92,40 mm)				
IHI 50J				
REF 144TA6966 (for rubber tracks) (inner guide) (Ø flange = 132,00 mm) (Ø body = 110,00 mm)				
REF 163TA9427 (for rubber tracks) (outer guide) (Ø flange = 110,00 mm) (Ø body = 92,40 mm)				
IHI 50UJ				
REF 144TA6966 (for rubber tracks) (inner guide) (Ø flange = 132,00 mm) (Ø body = 110,00 mm)				
REF 163TA9427 (for rubber tracks) (outer guide) (Ø flange = 110,00 mm) (Ø body = 92,40 mm)				

TRACKS & UNDERCARRIAGE PARTS



used for IHI

used for IHI				
TRACK ROLLER	TOP ROLLER	SPROCKET	IDLER	TRACK
				
IHI 50UX				
	REF 163TA9394 (assembly) (for rubber tracks) (Ø body = 70,30 mm)			REF 144TA6241 (rubber) (400 x 72,5 x 74)
IHI 50VX				
REF 144TA6966 (for rubber tracks) (Ø flange = 132,00 mm) (Ø body = 110,00 mm)	REF 163TA9395 (assembly) (for rubber tracks) (Ø body = 70,30 mm)			REF 144TA6241 (rubber) (400 x 72,5 x 74)
IHI 55J				
REF 164TA2949 (for rubber and steel tracks) (Ø flange = 110,00 mm) (Ø body = 92,40 mm)	REF 164TA2998 (assembly) (for rubber and steel tracks) (Ø body = 81,00 mm)	REF 164TA2968 (for rubber and steel tracks) (number of teeth = 21) (number of holes = 12)	REF 164TA2981 (front, with bracket assembly) (for rubber tracks) (Ø = 384,00 mm) REF 164TA2980 (front, with bracket assembly) (for steel tracks)	REF 164TA2950 (rubber) (400 x 72,5n x 74)
IHI 55N				
REF 144TA6966 (for rubber tracks) (Ø flange = 132,00 mm) (Ø body = 110,00 mm)	REF 163TA9397 (assembly) (for rubber tracks) (Ø body = 81,00 mm)	REF 144TA6967 (for rubber tracks) (number of teeth = 21) (number of holes = 12)	REF 164TA2981 (front, with bracket assembly) (for rubber tracks) (Ø = 384,00 mm)	REF 164TA3016 (rubber) (400 x 72,5 x 74)
IHI 55UJ3				
REF 144TA6966 (for rubber tracks) (Ø flange = 132,00 mm) (Ø body = 110,00 mm)	REF 163TA9398 (assembly) (for rubber tracks) (Ø body = 81,00 mm)	REF 144TA6967 (for rubber tracks) (number of teeth = 21) (number of holes = 12)	REF 164TA2981 (front, with bracket assembly) (for rubber tracks) (Ø = 384,00 mm)	REF 164TA3016 (rubber) (400 x 72,5 x 74)
IHI 55VX				
REF 144TA6966 (for rubber and steel tracks) (Ø flange = 132,00 mm) (Ø body = 110,00 mm)	REF 164TA2940 (assembly) (for rubber and steel tracks) (Ø body = 70,30 mm)	REF 164TA2997 (for rubber and steeltracks)	REF 164TA3004 (front, with bracket assembly) (for rubber and steeltracks) (Ø = 384,00 mm)	REF 164TA2965 (rubber) (400 x 72,5 x 74)
IHI 65NX				
REF 164TA2960 (for rubber tracks) (Ø flange = 132,00 mm) (Ø body = 110,00 mm)	REF 164TA2998 (assembly) (for rubber tracks) (Ø body = 81,00 mm)	REF 164TA2968 (for rubber tracks) (number of teeth = 21) (number of holes = 12)	REF 164TA3009 (front, with bracket assembly) (for rubber tracks) (Ø = 410,00 mm)	REF 164TA2964 (rubber) (400 x 72,5w x 82)
IHI 65VX				
REF 164TA2960 (for rubber tracks) (Ø flange = 132,00 mm) (Ø body = 110,00 mm)	REF 164TA2998 (assembly) (for rubber tracks) (Ø body = 81,00 mm)	REF 164TA2968 (for rubber tracks) (number of teeth = 21) (number of holes = 12)	REF 164TA3009 (front, with bracket assembly) (for rubber tracks) (Ø = 410,00 mm)	REF 164TA2964 (rubber) (400 x 72,5w x 82)
IHI 7J				
REF 143TA8664 (for rubber tracks)	REF 164TA2977 (guide) (for rubber tracks) (plate type)	REF 143TA9098 (for rubber tracks)	REF 164TA2993 (front, with bracket assembly) (for rubber tracks)	REF 164TA2942 (rubber) (180 x 72 x 37)
IHI 80NS				
REF 164TA3013 (for rubber and steel tracks)	REF 164TA2941 (assembly) (for rubber and steel tracks)	REF 144TA6967 (for rubber and steel tracks) (number of teeth = 21) (number of holes = 12)	REF 164TA2981 (front, with bracket assembly) (for rubber and steel tracks)	
IHI 80NX				
REF 163TA9431 (for rubber tracks) (Ø flange = 110,00 mm) (Ø body = 92,40 mm)	REF 163TA9400 (assembly) (for rubber tracks) (Ø body = 81,00 mm)	REF 144TA6967 (for rubber tracks) (number of teeth = 21) (number of holes = 12)	REF 164TA2981 (front, with bracket assembly) (for rubber tracks) (Ø = 384,00 mm)	REF 164TA2959 (rubber) (450 x 71 x 82)







used for IHI				
TRACK ROLLER	TOP ROLLER	SPROCKET	IDLER	TRACK
				
IHI 80NX3				
REF 164TA2949 (for rubber and steel tracks) (Ø flange = 110,00 mm) (Ø body = 92,40 mm)	REF 164TA2998 (assembly) (for rubber and steel tracks) (Ø body = 81,00 mm)	REF 144TA6967 (for rubber and steel tracks) (number of teeth = 21) (number of holes = 12)	REF 164TA2985 (front, with bracket assembly) (for rubber tracks) (Ø = 384,00 mm) REF 164TA2990 (front, with bracket assembly) (for steel tracks)	REF 164TA2959 (rubber) (450 x 71 x 82)
IHI 80VX				
REF 164TA2949 (for rubber and steel tracks) (Ø flange = 110,00 mm) (Ø body = 92,40 mm)	REF 164TA2998 (assembly) (for rubber and steel tracks) (Ø body = 81,00 mm)	REF 144TA6967 (for rubber and steel tracks) (number of teeth = 21) (number of holes = 12)	REF 164TA2985 (front, with bracket assembly) (for rubber tracks) (Ø = 384,00 mm) REF 164TA2990 (front, with bracket assembly) (for steel tracks)	REF 164TA2959 (rubber) (450 x 71 x 82)
IHI 80VX2				
REF 164TA2967 (for rubber and steel tracks)	REF 164TA2941 (assembly) (for rubber and steel tracks)	REF 144TA6967 (for rubber and steel tracks) (number of teeth = 21) (number of holes = 12)	REF 164TA3009 (front, with bracket assembly) (for rubber and steel tracks) (Ø = 410,00 mm)	REF 164TA2959 (rubber) (450 x 71 x 82)
IHI 9NX				
REF 143TA8664 (for rubber tracks)		REF 143TA9098 (for rubber tracks)	REF 163TA9364 (front, with bracket assembly) (for rubber tracks)	REF 164TA2942 (rubber) (180 x 72 x 37)
IHI 9NX2				
REF 143TA8664 (for rubber tracks)		REF 143TA9098 (for rubber tracks)	REF 163TA9365 (front, with bracket assembly) (for rubber tracks)	REF 164TA2942 (rubber) (180 x 72 x 37)
IHI 9VX				
REF 143TA8664 (for rubber tracks)		REF 143TA9098 (for rubber tracks)	REF 163TA9366 (front, with bracket assembly) (for rubber tracks)	REF 164TA2942 (rubber) (180 x 72 x 37)
IHI 9VX3				
REF 143TA8664 (for rubber tracks)		REF 143TA9098 (for rubber tracks)	REF 163TA9367 (front, with bracket assembly) (for rubber tracks)	REF 164TA2942 (rubber) (180 x 72 x 37)
IHI IC45				
REF 144TA8710 (for rubber tracks)	REF 144TA8711 (assembly) (for rubber tracks)			
IHI IC70				
		REF 163TA9380 (for rubber tracks) (number of teeth = 14) (number of holes = 9)		REF 143TA9757 (rubber) (700 x 100 x 98)
IHI IS14				
		REF 163TA9381 (for rubber tracks) (number of teeth = 14) (number of holes = 9)		REF 164TA3073 (rubber) (230 x 72 x 43)



used for IHI

used for IHI				
TRACK ROLLER	TOP ROLLER	SPROCKET	IDLER	TRACK
				
IHI IS14G		REF 163TA9382 (for rubber tracks) (number of teeth = 14) (number of holes = 9)		REF 164TA3073 (rubber) (230 x 72 x 43)
IHI IS14GX		REF 163TA9383 (for rubber tracks) (number of teeth = 14) (number of holes = 9)		REF 164TA3073 (rubber) (230 x 72 x 43)
IHI IS14PX		REF 163TA9384 (for rubber tracks) (number of teeth = 14) (number of holes = 9)		REF 164TA3073 (rubber) (230 x 72 x 43)
IHI IS30F				
REF 144TA8708 (for steel tracks) (Ø flange = 113,00 mm) (Ø body = 90,00 mm)				
IHI IS30F2				
REF 144TA8708 (for steel tracks) (Ø flange = 113,00 mm) (Ø body = 90,00 mm)				
IHI IS30G				
REF 144TA8708 (for steel tracks) (Ø flange = 113,00 mm) (Ø body = 90,00 mm)			REF 163TA9368 (front, with bracket assembly) (for steel tracks) (Ø = 300,00 mm)	
IHI IS30G2				
REF 144TA8708 (for steel tracks) (Ø flange = 113,00 mm) (Ø body = 90,00 mm)			REF 163TA9368 (front, with bracket assembly) (for steel tracks) (Ø = 300,00 mm)	
IHI IS30GX				
REF 144TA8708 (for steel tracks) (Ø flange = 113,00 mm) (Ø body = 90,00 mm)				
IHI IS30J				
REF 144TA8708 (for steel tracks) (Ø flange = 113,00 mm) (Ø body = 90,00 mm)				
IHI IS35G				
REF 144TA8708 (for steel tracks) (Ø flange = 113,00 mm) (Ø body = 90,00 mm)			REF 163TA9369 (front, with bracket assembly) (for steel tracks) (Ø = 300,00 mm)	
IHI IS35G1				
			REF 164TA1512 (front, with bracket assembly) (for steel tracks) (Ø = 300,00 mm)	



used for IHI				
TRACK ROLLER	TOP ROLLER	SPROCKET	IDLER	TRACK
				
IHI IS35G2			REF 164TA1513 (front, with bracket assembly) (for steel tracks) ($\emptyset = 300,00$ mm)	
IHI IS35GX2				
REF 144TA8708 (for steel tracks) (\emptyset flange = 113,00 mm) (\emptyset body = 90,00 mm)				
IHI IS40G				
REF 164TA1515 (for rubber tracks) (\emptyset flange = 110,00 mm) (\emptyset body = 92,40 mm)	REF 164TA1514 (assembly) (for rubber tracks) (\emptyset body = 81,00 mm)			REF 164TA3014 (rubber) (400 x 72,5 x 70)
IHI IS40GX2				
REF 164TA1516 (for rubber tracks) (\emptyset flange = 133,00 mm) (\emptyset body = 110,10 mm)				REF 164TA2957 (rubber) (400 x 72,5w x 72)



USED FOR
JCB





TRACKS & UNDERCARRIAGE PARTS



used for JCB





used for JCB				
TRACK ROLLER	TOP ROLLER	SPROCKET	IDLER	TRACK
				
JCB 801				
S/N: 00645001 - 00645538				
			REF 163TA9145 (front, with bracket assembly) (for rubber tracks)	
S/N: 00645001 - 00645999				
		REF 163TA9128 (for rubber tracks) (number of teeth = 13)		REF 163TA9117 (rubber) (230 x 72 x 42)
S/N: 00645539 - 00649569 R				
			REF 163TA9146 (front, with bracket assembly) (for rubber tracks)	
S/N: 00648000 - 00649729				
		REF 163TA9128 (for rubber tracks) (number of teeth = 13)		REF 163TA9117 (rubber) (230 x 72 x 42)
S/N: 00648000 - 00649729 (S)				
			REF 163TA9146 (front, with bracket assembly) (for rubber tracks)	
S/N: 00649730 - 00649999				
		REF 144TA1898 (for rubber tracks) (number of teeth = 19) (number of holes = 9)	REF 163TA9147 (front, with bracket assembly) (for rubber tracks)	REF 163TA9118 (rubber) (230 x 96 x 31)
JCB 801.4				
S/N: 00720001 - 00725162				
REF 144TA6943 (for rubber tracks) (Ø flange = 107,00 mm) (Ø body = 86,00 mm)		REF 144TA1898 (for rubber tracks) (number of teeth = 19) (number of holes = 9)	REF 163TA9241 (front, wheel only) (for rubber tracks) (Ø = 281,00 mm)	REF 164TA3052 (rubber) (230 x 96 x 31)
JCB 8015				
S/N: 00730800 - 00731999				
REF 163TA9134 (for rubber tracks) (Ø flange = 104,00 mm) (Ø body = 86,00 mm)		REF 144TA1898 (for rubber tracks) (number of teeth = 19) (number of holes = 9)	REF 163TA9241 (wheel only) (for rubber tracks) (only wheel)	REF 163TA9118 (rubber) (230 x 96 x 31)
S/N: 00820000 - 00821999				
REF 163TA9134 (for rubber tracks) (Ø flange = 104,00 mm) (Ø body = 86,00 mm)		REF 144TA1898 (for rubber tracks) (number of teeth = 19) (number of holes = 9)	REF 163TA9241 (wheel only) (for rubber tracks) (only wheel)	REF 163TA9118 (rubber) (230 x 96 x 31)
S/N: 00894000 - 00895999				
REF 163TA9134 (for rubber tracks) (Ø flange = 104,00 mm) (Ø body = 86,00 mm)			REF 163TA9241 (wheel only) (for rubber tracks) (only wheel)	REF 163TA9118 (rubber) (230 x 96 x 31)
S/N: 00894900 - 00895999				
		REF 144TA1898 (for rubber tracks) (number of teeth = 19) (number of holes = 9)		







used for JCB				
TRACK ROLLER	TOP ROLLER	SPROCKET	IDLER	TRACK
				
<i>S/N: 01020000 - 01023999</i>				
REF 163TA9134 (for rubber tracks) (Ø flange = 104,00 mm) (Ø body = 86,00 mm)			REF 163TA9241 (wheel only) (for rubber tracks) (only wheel)	REF 163TA9118 (rubber) (230 x 96 x 31)
JCB 802				
<i>S/N: 02100001 - 00210999</i>				
REF 163TA9132 (for rubber tracks)		REF 163TA9129 (for rubber tracks)		REF 163TA9119 (rubber) (250 x 109 x 36)
JCB 8025 ZTS				
<i>S/N: 01226500 - 01228500</i>				
			REF 163TA9151 (front, with bracket assembly) (for rubber tracks)	REF 163TA9121 (rubber) (250 x 109 x 38) REF 163TA9125 (rubber) (250 x 109 x 41)
<i>S/N: 01740000 - 01741499</i>				
			REF 163TA9151 (front, with bracket assembly) (for rubber tracks)	REF 163TA9121 (rubber) (250 x 109 x 38) REF 163TA9125 (rubber) (250 x 109 x 41)
<i>S/N: 01908000 - 01908499</i>				
			REF 163TA9151 (front, with bracket assembly) (for rubber tracks)	REF 163TA9121 (rubber) (250 x 109 x 38) REF 163TA9125 (rubber) (250 x 109 x 41)
<i>S/N: 02020000 - 02020999</i>				
				REF 163TA9121 (rubber) (250 x 109 x 38) REF 163TA9122 (rubber) (250 x 52,5 x 78) REF 163TA9123 (rubber) (250 x 52,5 x 84) REF 163TA9124 (rubber) (300 x 52,5 x 84) REF 163TA9120 (rubber) (300 x 109 x 41)
<i>S/N: 02226007 - 02228007</i>				
			REF 163TA9150 (front, with bracket assembly) (for rubber tracks) (only wheel)	REF 163TA9121 (rubber) (250 x 109 x 38) REF 163TA9122 (rubber) (250 x 52,5 x 78) REF 163TA9123 (rubber) (250 x 52,5 x 84) REF 163TA9124 (rubber) (300 x 52,5 x 84) REF 163TA9120 (rubber) (300 x 109 x 41)



used for JCB

used for JCB				
TRACK ROLLER	TOP ROLLER	SPROCKET	IDLER	TRACK
				
JCB 8025 ZTS-Plus				
<i>S/N: 01226500 - 01228500</i>				
	REF 163TA9141 (assembly) (for rubber tracks) (Ø body = 75,00 mm)	REF 144TA6944 (for rubber tracks) (number of teeth = 23) (number of holes = 9) REF 163TA9131 (for rubber tracks) (number of holes = 12)		
<i>S/N: 01740000 - 01741499</i>				
	REF 163TA9141 (assembly) (for rubber tracks) (Ø body = 75,00 mm)	REF 144TA6944 (for rubber tracks) (number of teeth = 23) (number of holes = 9) REF 163TA9131 (for rubber tracks) (number of holes = 12)		
<i>S/N: 01908000 - 01908499</i>				
	REF 163TA9141 (assembly) (for rubber tracks) (Ø body = 75,00 mm)	REF 144TA6944 (for rubber tracks) (number of teeth = 23) (number of holes = 9) REF 163TA9131 (for rubber tracks) (number of holes = 12)		
<i>S/N: 02020000 - 02020999</i>				
REF 163TA9135 (for rubber tracks)	REF 163TA9135 (assembly) (for rubber tracks)	REF 163TA9131 (for rubber tracks) (number of holes = 12)		
<i>S/N: 02226007 - 02228007</i>				
REF 163TA9135 (for rubber tracks)	REF 163TA9135 (assembly) (for rubber tracks)	REF 163TA9131 (for rubber tracks) (number of holes = 12)		
JCB 8025ZTS				
<i>S/N: 02020000 - 02020999</i>				
			REF 163TA9150 (front, with bracket assembly) (for rubber tracks) (only wheel)	
JCB 803				
<i>S/N: 00665001 - 00665736</i>				
REF 163TA9133 (for rubber tracks) (Ø flange = 127,00 mm) (Ø body = 100,00 mm)	REF 163TA9253 (assembly) (for rubber tracks)	REF 163TA9130 (for rubber tracks) (number of teeth = 23) (number of holes = 9)		REF 163TA9120 (rubber) (300 x 109 x 41)
<i>S/N: 00666988 - 00667435</i>				
			REF 163TA9148 (front, with bracket assembly) (for rubber tracks) (RH) REF 163TA9149 (front, with bracket assembly) (for rubber tracks) (LH)	



used for JCB				
TRACK ROLLER	TOP ROLLER	SPROCKET	IDLER	TRACK
				
S/N: 00765001 - 00767004				
			REF 163TA9149 (front, with bracket assembly) (for rubber tracks) (LH) REF 163TA9148 (front, with bracket assembly) (for rubber tracks) (RH)	
JCB 803 Plus				
S/N: 00765607 - 00767004				
REF 163TA9138 (for rubber tracks) (centerflange - no groove) (Ø flange = 127,00 mm) (Ø body = 100,00 mm)	REF 163TA9143 (assembly) (for rubber tracks) (Ø body = 75,00 mm)	REF 163TA9130 (for rubber tracks) (number of teeth = 23) (number of holes = 9)	REF 163TA9242 (front, with bracket assembly) (for rubber tracks) (RH) REF 163TA9149 (front, with bracket assembly) (for rubber tracks) (LH)	REF 164TA3021 (rubber) (300 x 109 x 41)
S/N: 00766588 - 00767004				
		REF 163TA9130 (for rubber tracks) (number of teeth = 23) (number of holes = 9)		
S/N: 00820000 - 00827239				
REF 163TA9138 (for rubber tracks) (centerflange - no groove) (Ø flange = 127,00 mm) (Ø body = 100,00 mm)	REF 163TA9143 (assembly) (for rubber tracks) (Ø body = 75,00 mm)	REF 163TA9130 (for rubber tracks) (number of teeth = 23) (number of holes = 9)	REF 163TA9242 (front, with bracket assembly) (for rubber tracks) (RH) REF 163TA9149 (front, with bracket assembly) (for rubber tracks) (LH)	REF 164TA3021 (rubber) (300 x 109 x 41)
S/N: 00827035 - 00827603				
		REF 163TA9130 (for rubber tracks) (number of teeth = 23) (number of holes = 9)		
S/N: 00827240 - 00827715				
	REF 163TA9143 (assembly) (for rubber tracks) (Ø body = 75,00 mm)			
S/N: 00827240 - 00829326				
REF 163TA9136 (for rubber tracks) (centerflange - no groove) (Ø flange = 127,00 mm) (Ø body = 100,00 mm)			REF 163TA9242 (front, with bracket assembly) (for rubber tracks) (RH) REF 163TA9149 (front, with bracket assembly) (for rubber tracks) (LH)	REF 164TA3021 (rubber) (300 x 109 x 41)
S/N: 00827604 - 00829326				
		REF 144TA6944 (for rubber tracks) (number of teeth = 23) (number of holes = 9)		
S/N: 00827716 - 00829326				
	REF 163TA9141 (assembly) (for rubber tracks) (Ø body = 75,00 mm)			

TRACKS & UNDERCARRIAGE PARTS



used for JCB

used for JCB				
TRACK ROLLER	TOP ROLLER	SPROCKET	IDLER	TRACK
				
<i>S/N: 00829327 - 00829999</i>				
REF 163TA9136 (for rubber tracks) (centerflange - no groove) (Ø flange = 127,00 mm) (Ø body = 100,00 mm)	REF 163TA9141 (assembly) (for rubber tracks) (Ø body = 75,00 mm)	REF 144TA6944 (for rubber tracks) (number of teeth = 23) (number of holes = 9)	REF 163TA9242 (front, with bracket assembly) (for rubber tracks) (RH) REF 163TA9149 (front, with bracket assembly) (for rubber tracks) (LH)	REF 164TA3021 (rubber) (300 x 109 x 41)
<i>S/N: 01159001 - 01159999</i>				
REF 163TA9136 (for rubber tracks) (centerflange - no groove) (Ø flange = 127,00 mm) (Ø body = 100,00 mm)	REF 163TA9141 (assembly) (for rubber tracks) (Ø body = 75,00 mm)	REF 144TA6944 (for rubber tracks) (number of teeth = 23) (number of holes = 9)	REF 163TA9242 (front, with bracket assembly) (for rubber tracks) (RH) REF 163TA9149 (front, with bracket assembly) (for rubber tracks) (LH)	REF 164TA3021 (rubber) (300 x 109 x 41)
JCB 803 Super				
<i>S/N: 00765607 - 00767004</i>				
REF 163TA9138 (for rubber tracks) (centerflange - no groove) (Ø flange = 127,00 mm) (Ø body = 100,00 mm)	REF 163TA9143 (assembly) (for rubber tracks) (Ø body = 75,00 mm)	REF 163TA9130 (for rubber tracks) (number of teeth = 23) (number of holes = 9)	REF 163TA9242 (front, with bracket assembly) (for rubber tracks) (RH) REF 163TA9149 (front, with bracket assembly) (for rubber tracks) (LH)	REF 164TA3021 (rubber) (300 x 109 x 41)
<i>S/N: 00820000 - 00827239</i>				
REF 163TA9138 (for rubber tracks) (centerflange - no groove) (Ø flange = 127,00 mm) (Ø body = 100,00 mm)	REF 163TA9143 (assembly) (for rubber tracks) (Ø body = 75,00 mm)	REF 163TA9130 (for rubber tracks) (number of teeth = 23) (number of holes = 9)	REF 163TA9242 (front, with bracket assembly) (for rubber tracks) (RH) REF 163TA9149 (front, with bracket assembly) (for rubber tracks) (LH)	REF 164TA3021 (rubber) (300 x 109 x 41)
<i>S/N: 00827035 - 00827603</i>				
		REF 163TA9130 (for rubber tracks) (number of teeth = 23) (number of holes = 9)		
<i>S/N: 00827240 - 00082931</i>				
			REF 163TA9149 (front, with bracket assembly) (for rubber tracks) (LH)	
<i>S/N: 00827240 - 00827715</i>				
	REF 163TA9143 (assembly) (for rubber tracks) (Ø body = 75,00 mm)			
<i>S/N: 00827240 - 00829317</i>				
REF 163TA9136 (for rubber tracks) (centerflange - no groove) (Ø flange = 127,00 mm) (Ø body = 100,00 mm)			REF 163TA9242 (front, with bracket assembly) (for rubber tracks) (RH)	REF 164TA3021 (rubber) (300 x 109 x 41)
<i>S/N: 00827716 - 00829317</i>				
	REF 163TA9141 (assembly) (for rubber tracks) (Ø body = 75,00 mm)			



used for JCB				
TRACK ROLLER	TOP ROLLER	SPROCKET	IDLER	TRACK
S/N: 00827828 - 00829317				
				
		REF 144TA6944 (for rubber tracks) (number of teeth = 23) (number of holes = 9)		
S/N: 00829327 - 00829999				
REF 163TA9136 (for rubber tracks) (centerflange - no groove) (Ø flange = 127,00 mm) (Ø body = 100,00 mm)	REF 163TA9141 (assembly) (for rubber tracks) (Ø body = 75,00 mm)	REF 144TA6944 (for rubber tracks) (number of teeth = 23) (number of holes = 9)	REF 163TA9242 (front, with bracket assembly) (for rubber tracks) (RH) REF 163TA9149 (front, with bracket assembly) (for rubber tracks) (LH)	REF 164TA3021 (rubber) (300 x 109 x 41)
S/N: 00830000 - 00830000				
REF 163TA9136 (for rubber tracks) (centerflange - no groove) (Ø flange = 127,00 mm) (Ø body = 100,00 mm)	REF 163TA9141 (assembly) (for rubber tracks) (Ø body = 75,00 mm)	REF 144TA6944 (for rubber tracks) (number of teeth = 23) (number of holes = 9)	REF 163TA9242 (front, with bracket assembly) (for rubber tracks) (RH) REF 163TA9149 (front, with bracket assembly) (for rubber tracks) (LH)	REF 164TA3021 (rubber) (300 x 109 x 41)
S/N: 01159001 - 01159999				
REF 163TA9136 (for rubber tracks) (centerflange - no groove) (Ø flange = 127,00 mm) (Ø body = 100,00 mm)	REF 163TA9141 (assembly) (for rubber tracks) (Ø body = 75,00 mm)	REF 144TA6944 (for rubber tracks) (number of teeth = 23) (number of holes = 9)	REF 163TA9242 (front, with bracket assembly) (for rubber tracks) (RH) REF 163TA9149 (front, with bracket assembly) (for rubber tracks) (LH)	REF 164TA3021 (rubber) (300 x 109 x 41)
JCB 8030 ZTS				
S/N: 01228500 - 01228842				
REF 163TA9340 (for rubber tracks) (centerflange - no groove) (Ø flange = 127,00 mm) (Ø body = 100,00 mm)				
S/N: 01228500 - 01230499				
	REF 163TA9141 (assembly) (for rubber tracks) (Ø body = 75,00 mm)		REF 163TA9151 (front, with bracket assembly) (for rubber tracks) (RH) REF 163TA9150 (front, with bracket assembly) (for rubber tracks) (only wheel) (LH)	REF 163TA9120 (rubber) (300 x 109 x 41)
S/N: 01228843 - 01230499				
REF 163TA9137 (for rubber tracks) (Ø flange = 127,00 mm) (Ø body = 100,00 mm)				
S/N: 01908500 - 01908999				
REF 163TA9137 (for rubber tracks) (Ø flange = 127,00 mm) (Ø body = 100,00 mm)	REF 163TA9141 (assembly) (for rubber tracks) (Ø body = 75,00 mm)	REF 144TA6944 (for rubber tracks) (number of teeth = 23) (number of holes = 9) REF 163TA9131 (for rubber tracks) (number of holes = 12)	REF 163TA9151 (front, with bracket assembly) (for rubber tracks) (RH) REF 163TA9150 (front, with bracket assembly) (for rubber tracks) (only wheel) (LH)	REF 163TA9120 (rubber) (300 x 109 x 41)





TRACKS & UNDERCARRIAGE PARTS



used for JCB

used for JCB				
TRACK ROLLER	TOP ROLLER	SPROCKET	IDLER	TRACK
				
<i>S/N: 02020149 - 02020149</i>				
REF 143TA8667 (for rubber tracks) (Ø flange = 127,00 mm) (Ø body = 100,00 mm)	REF 163TA9142 (assembly) (for rubber tracks) (Ø body = 75,00 mm)	REF 163TA9131 (for rubber tracks) (number of holes = 12) REF 144TA6944 (for rubber tracks) (number of teeth = 23) (number of holes = 9)	REF 163TA9150 (front, with bracket assembly) (for rubber tracks) (only wheel) (LH) REF 163TA9151 (front, with bracket assembly) (for rubber tracks) (RH)	REF 163TA9120 (rubber) (300 x 109 x 41) REF 143TA9765 (rubber) (350 x 52,5 x 84) REF 163TA9122 (rubber) (250 x 52,5 x 78)
<i>S/N: 02021000 - 02021999</i>				
REF 143TA8667 (for rubber tracks) (Ø flange = 127,00 mm) (Ø body = 100,00 mm)	REF 163TA9142 (assembly) (for rubber tracks) (Ø body = 75,00 mm)	REF 163TA9131 (for rubber tracks)	REF 163TA9150 (front, with bracket assembly) (for rubber tracks) (only wheel) (LH) REF 163TA9151 (front, with bracket assembly) (for rubber tracks) (RH)	REF 163TA9120 (rubber) (300 x 109 x 41) REF 143TA9765 (rubber) (350 x 52,5 x 84) REF 163TA9122 (rubber) (250 x 52,5 x 78)
<i>S/N: 02116878 - 02117878</i>				
REF 143TA8667 (for rubber tracks) (Ø flange = 127,00 mm) (Ø body = 100,00 mm)	REF 163TA9142 (assembly) (for rubber tracks) (Ø body = 75,00 mm)	REF 163TA9131 (for rubber tracks)	REF 163TA9151 (front, with bracket assembly) (for rubber tracks) (RH) REF 163TA9150 (front, with bracket assembly) (for rubber tracks) (only wheel) (LH)	REF 163TA9120 (rubber) (300 x 109 x 41) REF 143TA9765 (rubber) (350 x 52,5 x 84) REF 163TA9122 (rubber) (250 x 52,5 x 78)
<i>S/N: 02432101 - 02433100</i>				
REF 143TA8667 (for rubber tracks) (Ø flange = 127,00 mm) (Ø body = 100,00 mm)	REF 163TA9142 (assembly) (for rubber tracks) (Ø body = 75,00 mm)	REF 163TA9131 (for rubber tracks)	REF 163TA9151 (front, with bracket assembly) (for rubber tracks) (RH) REF 163TA9150 (front, with bracket assembly) (for rubber tracks) (only wheel) (LH)	REF 163TA9120 (rubber) (300 x 109 x 41) REF 143TA9765 (rubber) (350 x 52,5 x 84) REF 163TA9122 (rubber) (250 x 52,5 x 78)
JCB 8060				
<i>S/N: 00883000 - 00884999</i>				
REF 144TA8713 (for rubber tracks) (Ø flange = 140,00 mm) (Ø body = 110,00 mm)	REF 163TA9139 (assembly) (for rubber tracks) (Ø body = 90,00 mm)		REF 163TA9144 (front, with bracket assembly) (for rubber tracks)	REF 163TA9244 (rubber) (400 x 72,5 x 74)
<i>S/N: 01236000 - 01237999</i>				
REF 144TA8713 (for rubber tracks) (Ø flange = 140,00 mm) (Ø body = 110,00 mm)	REF 163TA9139 (assembly) (for rubber tracks) (Ø body = 90,00 mm)		REF 163TA9144 (front, with bracket assembly) (for rubber tracks)	REF 163TA9244 (rubber) (400 x 72,5 x 74)



used for JCB				
TRACK ROLLER	TOP ROLLER	SPROCKET	IDLER	TRACK
				
JCB 8065 DL				
S/N: 01538310 - 01538999				
		REF 163TA9127 (for rubber tracks)	REF 163TA9243 (front, with bracket assembly) (for rubber tracks)	REF 163TA9116 (rubber) (400 x 72,5 x 74)
JCB 8065 RTS				
S/N: 01537500 - 01538309				
	REF 163TA9139 (assembly) (for rubber tracks) (Ø body = 90,00 mm)	REF 163TA9127 (for rubber tracks)		REF 163TA9116 (rubber) (400 x 72,5 x 74)
S/N: 15437500 - 01538309				
REF 144TA8713 (for rubber tracks) (Ø flange = 140,00 mm) (Ø body = 110,00 mm)				
JCB 8080				
S/N: 01024000 - 01025999				
REF 144TA6949 (for rubber tracks) (Ø flange = 132,00 mm) (Ø body = 110,00 mm)	REF 144TA6954 (assembly) (for rubber tracks) (Ø flange = 103,00 mm) (Ø body = 86,30 mm)	REF 164TA3087 (for rubber tracks) (number of teeth = 21) (number of holes = 12)	REF 144TA6950 (front, with bracket assembly) (for rubber tracks) (Ø = 452,00 mm)	REF 143TA9771 (rubber) (450 x 81,5 x 76)
S/N: 01442000 - 01443999				
REF 144TA6949 (for rubber tracks) (Ø flange = 132,00 mm) (Ø body = 110,00 mm)	REF 144TA6954 (assembly) (for rubber tracks) (Ø flange = 103,00 mm) (Ø body = 86,30 mm)	REF 164TA3087 (for rubber tracks) (number of teeth = 21) (number of holes = 12)	REF 144TA6950 (front, with bracket assembly) (for rubber tracks) (Ø = 452,00 mm)	REF 143TA9771 (rubber) (450 x 81,5 x 76)



USED FOR
JLG





TRACKS & UNDERCARRIAGE PARTS



used for JLG

used for JLG				
TRACK ROLLER	TOP ROLLER	SPROCKET	IDLER	TRACK
				
JLG 400SC				
REF 164TA1533 (for steel tracks) (frame = gradall)	REF 164TA1534 (assembly)	REF 164TA1531	REF 164TA1532 (front, with tensioner)	REF 164TA1530 (rubber) (bridgestone poland) REF 164TA1529 (rubber) (400 x 72,5 x 82) REF 164TA1528 (steel)
JLG 600SC				
REF 143TA8668 (for steel tracks) (frame = caterpillar)	REF 143TA8926 (assembly) (for steel tracks) (frame = caterpillar)	REF 143TA9106 (for steel tracks) (frame = caterpillar)	REF 143TA9376 (front, with bracket assembly) (for steel tracks) (frame = caterpillar)	
REF 144TA8449 (for steel tracks) (frame = gradall)	REF 144TA8298 (assembly) (for steel tracks) (frame = caterpillar)	REF 144TA8138 (for steel tracks) (frame = gradall) (number of teeth = 21) (number of holes = 15)	REF 144TA7959 (front, with bracket assembly) (for steel tracks) (frame = gradall)	
JLG 600SJC				
REF 144TA8450 (for steel tracks) (frame = gradall)	REF 144TA8299 (assembly)	REF 144TA8139 (number of teeth = 21) (number of holes = 15)	REF 143TA9376 (front, with bracket assembly) (for steel tracks) (frame = caterpillar)	
REF 143TA8668 (for steel tracks) (frame = caterpillar)		REF 143TA9106 (for steel tracks) (frame = caterpillar)	REF 144TA7960 (front, with bracket assembly) (for steel tracks) (frame = gradall)	
JLG 660SJC				
REF 143TA8668 (for steel tracks) (frame = caterpillar)	REF 143TA8926 (assembly) (for steel tracks) (frame = caterpillar)	REF 143TA9106 (for steel tracks) (frame = caterpillar)	REF 144TA7959 (front, with bracket assembly) (for steel tracks) (frame = gradall)	
REF 144TA8449 (for steel tracks) (frame = gradall)	REF 144TA8298 (assembly) (for steel tracks) (frame = gradall)	REF 144TA8138 (for steel tracks) (frame = gradall) (number of teeth = 21) (number of holes = 15)	REF 144TA7960 (front, with bracket assembly) (for steel tracks) (frame = gradall)	
REF 144TA8450 (for steel tracks) (frame = gradall)	REF 144TA8299 (assembly) (for steel tracks) (frame = gradall)	REF 144TA8139 (number of teeth = 21) (number of holes = 15)	REF 143TA9376 (front, with bracket assembly) (for steel tracks) (frame = caterpillar)	
JLG X14				
REF 144TA8667 (for rubber tracks) (Ø flange = 134,00 mm) (Ø body = 60,00 mm)			REF 144TA8116 (front, with bracket assembly) (for rubber tracks) (Ø = 223,00 mm)	REF 143TA9773 (rubber) (180 x 72 x 37)
JLG X17J				
REF 144TA8667 (for rubber tracks) (Ø flange = 134,00 mm) (Ø body = 60,00 mm)		REF 144TA8284 (for rubber tracks) (number of teeth = 11) (number of holes = 8)	REF 144TA8116 (front, with bracket assembly) (for rubber tracks) (Ø = 223,00 mm)	REF 143TA9773 (rubber) (180 x 72 x 37)
JLG X17J/3				
			REF 144TA8116 (front, with bracket assembly) (for rubber tracks) (Ø = 223,00 mm)	



used for JLG				
TRACK ROLLER	TOP ROLLER	SPROCKET	IDLER	TRACK
				
JLG X17J/4			REF 144TA8116 (front, with bracket assembly) (for rubber tracks) (Ø = 223,00 mm)	
JLG X17JP/2			REF 144TA8116 (front, with bracket assembly) (for rubber tracks) (Ø = 223,00 mm)	
JLG X19J			REF 144TA8116 (front, with bracket assembly) (for rubber tracks) (Ø = 223,00 mm)	REF 143TA9773 (rubber) (180 x 72 x 37)
JLG X19JA			REF 144TA8116 (front, with bracket assembly) (for rubber tracks) (Ø = 223,00 mm)	REF 143TA9773 (rubber) (180 x 72 x 37)
JLG X390AJ			REF 144TA8116 (front, with bracket assembly) (for rubber tracks) (Ø = 223,00 mm)	REF 143TA9773 (rubber) (180 x 72 x 37)
REF 144TA8667 (for rubber tracks) (Ø flange = 134,00 mm) (Ø body = 60,00 mm)			REF 144TA8116 (front, with bracket assembly) (for rubber tracks) (Ø = 223,00 mm)	REF 143TA9773 (rubber) (180 x 72 x 37)
JLG X500AJ			REF 144TA8116 (front, with bracket assembly) (for rubber tracks) (Ø = 223,00 mm)	
JLG X550AJ			REF 144TA8116 (front, with bracket assembly) (for rubber tracks) (Ø = 223,00 mm)	REF 143TA9773 (rubber) (180 x 72 x 37)



USED FOR
KOBELCO







used for KOBELCO				
TRACK ROLLER	TOP ROLLER	SPROCKET	IDLER	TRACK
				
KOBELCO 17SR-3				
<i>S/P: PU08 - S/N: 05001 - and up</i>				
REF 163TA9490		REF 143TA9041 (number of teeth = 19) (number of holes = 9)	REF 163TA9505 (front, with bracket assembly) (Ø = 270,00 mm)	REF 163TA9466 (rubber) (230 x 48 x 70)
KOBELCO 27SR				
REF 143TA8567 (Ø flange = 108,00 mm) (Ø body = 85,00 mm)	REF 143TA8902 (assembly) (Ø body = 75,00 mm)	REF 143TA9043 (number of teeth = 19) (number of holes = 12)	REF 143TA9593 (front, with bracket assembly) (Ø = 271,00 mm)	REF 163TA9468 (rubber) (250 x 52,5 x 80)
KOBELCO 27SR-3				
REF 143TA8567 (Ø flange = 108,00 mm) (Ø body = 85,00 mm)	REF 143TA8902 (assembly) (Ø body = 75,00 mm)	REF 143TA9043 (number of teeth = 19) (number of holes = 12)	REF 144TA7927 (front, with bracket assembly) (LH) (Ø = 346,00 mm) REF 163TA9507 (front, with bracket assembly) (RH)	REF 163TA9468 (rubber) (250 x 52,5 x 80)
KOBELCO 27SR-5				
<i>S/P: PV13 - S/N: 33453 - and up</i>				
REF 143TA8567 (Ø flange = 108,00 mm) (Ø body = 85,00 mm)	REF 163TA9502 (assembly)	REF 143TA9043 (number of teeth = 19) (number of holes = 12)	REF 143TA9593 (front, with bracket assembly) (Ø = 271,00 mm)	REF 163TA9468 (rubber) (250 x 52,5 x 80)
KOBELCO 30SR				
<i>S/P: PW - S/N: 03501 - 10105</i>				
REF 163TA9487 (Ø flange = 148,00 mm) (Ø body = 93,00 mm)	REF 163TA9500 (assembly) (Ø body = 75,00 mm)	REF 143TA9115 (number of teeth = 23) (number of holes = 9)	REF 143TA9383 (front, with bracket assembly)	REF 163TA9469 (rubber) (300 x 52,5 x 82)
<i>S/P: PW14 - S/N: 45964 - and up</i>				
REF 143TA8567 (Ø flange = 108,00 mm) (Ø body = 85,00 mm)	REF 163TA9500 (assembly) (Ø body = 75,00 mm)	REF 163TA9480 (number of teeth = 23) (number of holes = 9)	REF 163TA9508 (front, with bracket assembly)	REF 163TA9470 (rubber) (300 x 52,5 x 88)
KOBELCO 30SR-2				
REF 164TA2559 (Ø flange = 148,00 mm) (Ø body = 93,00 mm)	REF 164TA2119 (assembly) (Ø body = 75,00 mm)	REF 164TA2560 (number of teeth = 23) (number of holes = 9)	REF 143TA9300 (front, with bracket assembly) (Ø = 345,00 mm)	REF 163TA9471 (rubber) (300 x 52,5 x 82) REF 163TA9472 (rubber) (300 x 52,5 x 88)
KOBELCO 30SR-3				
REF 164TA2559 (Ø flange = 148,00 mm) (Ø body = 93,00 mm)	REF 164TA2119 (assembly) (Ø body = 75,00 mm)	REF 164TA2560 (number of teeth = 23) (number of holes = 9)	REF 143TA9300 (front, with bracket assembly) (Ø = 345,00 mm)	REF 163TA9471 (rubber) (300 x 52,5 x 82) REF 163TA9472 (rubber) (300 x 52,5 x 88)
KOBELCO 30SR-5				
REF 143TA8567 (Ø flange = 108,00 mm) (Ø body = 85,00 mm)	REF 143TA8902 (assembly) (Ø body = 75,00 mm)	REF 163TA9480 (number of teeth = 23) (number of holes = 9)	REF 163TA9508 (front, with bracket assembly)	REF 163TA9470 (rubber) (300 x 52,5 x 88)
KOBELCO 35SR				
REF 143TA8567 (Ø flange = 108,00 mm) (Ø body = 85,00 mm)	REF 143TA8902 (assembly) (Ø body = 75,00 mm)	REF 163TA9480 (number of teeth = 23) (number of holes = 9)	REF 163TA9508 (front, with bracket assembly)	REF 164TA2033 (rubber) (300 x 52,5 x 88)
KOBELCO 35SR-2				
REF 164TA2559 (Ø flange = 148,00 mm) (Ø body = 93,00 mm)	REF 164TA2119 (assembly) (Ø body = 75,00 mm)	REF 164TA2560 (number of teeth = 23) (number of holes = 9)	REF 143TA9300 (front, with bracket assembly) (Ø = 345,00 mm)	REF 163TA9471 (rubber) (300 x 52,5 x 82)

TRACKS & UNDERCARRIAGE PARTS



used for KOBELCO

used for KOBELCO				
TRACK ROLLER	TOP ROLLER	SPROCKET	IDLER	TRACK
				
				REF 163TA9472 (rubber) (300 x 52,5 x 88)
KOBELCO 35SR-3				
REF 143TA8567 (Ø flange = 108,00 mm) (Ø body = 85,00 mm)	REF 143TA8902 (assembly) (Ø body = 75,00 mm)	REF 163TA9480 (number of teeth = 23) (number of holes = 9)	REF 163TA9510 (front, with bracket assembly)	REF 164TA2034 (rubber) (300 x 52,5 x 88)
KOBELCO 35SR-5				
REF 143TA8567 (Ø flange = 108,00 mm) (Ø body = 85,00 mm)	REF 143TA8902 (assembly) (Ø body = 75,00 mm)	REF 163TA9480 (number of teeth = 23) (number of holes = 9)	REF 163TA9508 (front, with bracket assembly)	REF 163TA9470 (rubber) (300 x 52,5 x 88)
KOBELCO 50SR				
		REF 143TA9047 REF 163TA9482 (number of teeth = 19) (number of holes = 12) (total height = 32,20 mm)	REF 164TA2134 (front, with bracket assembly)	REF 163TA9473 (rubber) (400 x 74 x 72)
KOBELCO 50SR-3				
<i>S/P: PJ04 - S/N: 03001 - 05152</i>				
		REF 143TA9047 REF 163TA9482 (number of teeth = 19) (number of holes = 12) (total height = 32,20 mm)	REF 163TA9511 (front, with bracket assembly) (Ø = 362,00 mm)	REF 163TA9473 (rubber) (400 x 74 x 72)
<i>S/P: PJ05 - S/N: 06001 - and up</i>				
		REF 143TA9047 REF 163TA9482 (number of teeth = 19) (number of holes = 12) (total height = 32,20 mm)	REF 163TA9511 (front, with bracket assembly) (Ø = 362,00 mm)	REF 163TA9473 (rubber) (400 x 74 x 72)
KOBELCO 50SR-5				
<i>S/P: PJ06 - S/N: 09807 - and up</i>				
	REF 163TA9503 (assembly) (for rubber tracks) (Ø body = 82,00 mm)	REF 143TA9047 (number of teeth = 19) (number of holes = 12) REF 163TA9482 (number of teeth = 19) (number of holes = 12) (total height = 32,20 mm)	REF 163TA9512 (front, with bracket assembly)	REF 163TA9473 (rubber) (400 x 74 x 72)
KOBELCO SK013				
<i>S/P: PN</i>				
REF 144TA8555 (Ø flange = 112,00 mm) (Ø body = 88,00 mm)		REF 144TA8198 (number of teeth = 19) (number of holes = 9)	REF 144TA8027 (front, with bracket assembly)	REF 143TA9634 (rubber) (230 x 48 x 70)
KOBELCO SK014				
<i>S/P: PU - S/N: 00750 - and up</i>				
REF 163TA9493		REF 163TA9483 (number of teeth = 19) (number of holes = 9)	REF 163TA9513 (front, with bracket assembly)	REF 163TA9474 (rubber) (230 x 72 x 43)



used for KOBELCO

used for KOBELCO				
TRACK ROLLER	TOP ROLLER	SPROCKET	IDLER	TRACK
				
KOBELCO SK015				
<i>S/P: PU - S/N: 02001 - and up</i>				
REF 163TA9494 (∅ flange = 112,00 mm) (∅ body = 88,00 mm)		REF 163TA9484 (number of teeth = 19) (number of holes = 9)	REF 163TA9513 (front, with bracket assembly)	REF 163TA9474 (rubber) (230 x 72 x 43)
KOBELCO SK015R				
			REF 144TA8034 (front, with bracket assembly) (for rubber tracks)	REF 143TA9779 (rubber) (230 x 96 x 31)
KOBELCO SK015SR				
REF 144TA8559 (for rubber tracks) (∅ flange = 112,00 mm) (∅ body = 88,00 mm)		REF 144TA8202 (for rubber tracks) (number of teeth = 19) (number of holes = 9)	REF 144TA8035 (front, with bracket assembly) (for rubber tracks)	REF 143TA9779 (rubber) (230 x 96 x 31)
KOBELCO SK020				
<i>S/P: PM</i>				
REF 144TA8560 (for rubber tracks) (∅ flange = 118,00 mm) (∅ body = 94,00 mm)		REF 143TA9111 (for rubber tracks)	REF 144TA8037 (front, with bracket assembly) (for rubber tracks) (∅ = 346,00 mm)	REF 143TA9780 (rubber) (300 x 109 x 35)
<i>S/P: PM - S/N: 00401 - 02000</i>				
REF 144TA8560 (for rubber tracks) (∅ flange = 118,00 mm) (∅ body = 94,00 mm)		REF 144TA8203 (for rubber tracks) REF 143TA9111 (for rubber tracks)	REF 144TA8037 (front, with bracket assembly) (for rubber tracks) (∅ = 346,00 mm)	REF 143TA9780 (rubber) (300 x 109 x 35)
KOBELCO SK024				
<i>S/P: PV - S/N: 00003 - 02536</i>				
			REF 164TA2135 (front, with bracket assembly) (for rubber tracks) (∅ = 346,00 mm) REF 163TA9514 (front, with bracket assembly) (for steel tracks)	
<i>S/P: PV - S/N: 00003 - and up</i>				
REF 163TA9495 (∅ flange = 133,00 mm) (∅ body = 93,00 mm)	REF 163TA9500 (assembly) (∅ body = 75,00 mm)	REF 164TA2560 (number of teeth = 23) (number of holes = 9)		REF 163TA9475 (rubber) (300 x 109 x 38)
<i>S/P: PV - S/N: 02600 - and up</i>				
			REF 164TA2135 (front, with bracket assembly) (∅ = 346,00 mm)	
KOBELCO SK025				
<i>S/P: PV - S/N: 04301 - 06200</i>				
REF 163TA9496 (∅ flange = 118,00 mm) (∅ body = 94,00 mm)	REF 163TA9500 (assembly) (∅ body = 75,00 mm)	REF 143TA9115 (number of teeth = 23) (number of holes = 9)	REF 163TA9515 (front, with bracket assembly) (∅ = 346,00 mm)	REF 163TA9475 (rubber) (300 x 109 x 38)
KOBELCO SK025-2				
<i>S/P: PV - S/N: 06201 - and up</i>				
REF 163TA9496 (∅ flange = 118,00 mm) (∅ body = 94,00 mm)	REF 163TA9500 (assembly) (∅ body = 75,00 mm)	REF 143TA9115 (number of teeth = 23) (number of holes = 9)	REF 163TA9515 (front, with bracket assembly) (∅ = 346,00 mm)	REF 163TA9475 (rubber) (300 x 109 x 38)



used for KOBELCO				
TRACK ROLLER	TOP ROLLER	SPROCKET	IDLER	TRACK
				
KOBELCO SK030				
<i>S/P: PW - S/N: 03001 - and up</i>				
REF 163TA9496 (Ø flange = 118,00 mm) (Ø body = 94,00 mm)	REF 163TA9500 (assembly) (Ø body = 75,00 mm)	REF 164TA2560 (number of teeth = 23) (number of holes = 9)	REF 163TA9515 (front, with bracket assembly) (Ø = 346,00 mm)	REF 163TA9476 (rubber) (300 x 109 x 40)
KOBELCO SK030-2				
<i>S/P: PW - S/N: 04401 - and up</i>				
REF 163TA9496 (Ø flange = 118,00 mm) (Ø body = 94,00 mm)	REF 163TA9500 (assembly) (Ø body = 75,00 mm)	REF 164TA2560 (number of teeth = 23) (number of holes = 9)	REF 163TA9515 (front, with bracket assembly) (Ø = 346,00 mm)	REF 163TA9476 (rubber) (300 x 109 x 40)
KOBELCO SK035				
<i>S/P: PX - S/N: 01201 - and up</i>				
REF 163TA9496 (Ø flange = 118,00 mm) (Ø body = 94,00 mm)	REF 163TA9500 (assembly) (Ø body = 75,00 mm)	REF 164TA2078	REF 163TA9515 (front, with bracket assembly) (Ø = 346,00 mm)	REF 164TA2035 (rubber) (350 x 52,5 x 86)
KOBELCO SK035-2				
<i>S/P: PX - S/N: 02101 - and up</i>				
REF 163TA9496 (Ø flange = 118,00 mm) (Ø body = 94,00 mm)	REF 163TA9500 (assembly) (Ø body = 75,00 mm)	REF 164TA2560 (number of teeth = 23) (number of holes = 9)	REF 163TA9515 (front, with bracket assembly) (Ø = 346,00 mm)	REF 164TA2035 (rubber) (350 x 52,5 x 86)
KOBELCO SK042				
<i>S/P: PY</i>				
REF 144TA8577 (for rubber tracks) (Ø flange = 140,00 mm) (Ø body = 110,00 mm)				REF 143TA9785 (rubber) (400 x 72,5 x 72)
REF 144TA8575 (for rubber tracks) (Ø flange = 205,00 mm) (Ø body = 100,00 mm)				
<i>For all other serial ranges applicable</i>				
REF 144TA8575 (for rubber tracks) (Ø flange = 205,00 mm) (Ø body = 100,00 mm)				
KOBELCO SK04-2				
<i>S/P: LW - S/N: 07801 - 08644</i>				
REF 164TA2104	REF 164TA2118 (assembly)	REF 164TA2077 (standard) REF 164TA1015 (long tracks)	REF 164TA2133 (front, with bracket assembly)	
KOBELCO SK042(Old)				
<i>S/P: PY - S/N: 00005 - 00585</i>				
REF 144TA8576 (for rubber tracks) (Ø flange = 140,00 mm) (Ø body = 110,00 mm)			REF 144TA8052 (front, with bracket assembly) (for rubber tracks) (Ø = 389,00 mm)	REF 143TA9785 (rubber) (400 x 72,5 x 72)
KOBELCO SK045				
<i>S/P: PY</i>				
REF 144TA8578 (for rubber tracks) (double guide) (Ø flange = 130,00 mm) (Ø body = 100,00 mm)	REF 144TA8344 (assembly) (for rubber tracks) (Ø body = 88,00 mm)	REF 144TA8215 (for rubber tracks)	REF 144TA8054 (front, with bracket assembly) (for rubber tracks)	REF 143TA9767 (rubber) (400 x 72,5 x 74)
REF 144TA8579 (for rubber tracks) (inner guide) (Ø flange = 130,00 mm) (Ø body = 100,00 mm)				

TRACKS & UNDERCARRIAGE PARTS



used for KOBELCO

used for KOBELCO				
TRACK ROLLER	TOP ROLLER	SPROCKET	IDLER	TRACK
				
KOBELCO SK045-2				
<i>S/P: PY - S/N: 03501 - 06000</i>				
	REF 144TA8345 (assembly) (for rubber tracks) (Ø body = 88,00 mm)		REF 144TA8053 (front, with bracket assembly) (for rubber tracks)	REF 143TA9767 (rubber) (400 x 72,5 x 74)
KOBELCO SK09SR				
			REF 144TA8055 (front, with bracket assembly) (for rubber tracks)	REF 143TA9669 (rubber) (180 x 72 x 40) (with rail)
KOBELCO SK13SR				
<i>S/P: PE01 - S/N: 00101 - and up</i>				
REF 163TA9485 (Ø flange = 114,00 mm) (Ø body = 74,00 mm)		REF 143TA9041 (number of teeth = 19) (number of holes = 9)	REF 163TA9516 (front, with bracket assembly) (Ø = 270,00 mm)	REF 163TA9466 (rubber) (230 x 48 x 70)
KOBELCO SK15				
REF 144TA8584 (Ø flange = 114,00 mm) (Ø body = 74,00 mm)			REF 144TA8057 (front, with bracket assembly) (Ø = 270,00 mm)	REF 143TA9779 (rubber) (230 x 96 x 31)
KOBELCO SK15SR				
<i>S/P: PU - S/N: 06001 - and up</i>				
REF 163TA9486 (Ø flange = 114,00 mm) (Ø body = 74,00 mm)		REF 163TA9478 (number of teeth = 19) (number of holes = 8)	REF 164TA2129 (front, with bracket assembly)	REF 143TA9779 (rubber) (230 x 96 x 31)
KOBELCO SK16(2015)				
		REF 163TA9292 (number of teeth = 14) (number of holes = 9)	REF 163TA9446 (front, with bracket assembly)	REF 163TA9274 (rubber) (230 x 72 x 47)
KOBELCO SK17SR-3				
<i>S/P: PU09 - S/N: 08001 - and up</i>				
REF 163TA9485 (Ø flange = 114,00 mm) (Ø body = 74,00 mm)		REF 143TA9041 (number of teeth = 19) (number of holes = 9)	REF 163TA9505 (front, with bracket assembly) (Ø = 270,00 mm)	REF 163TA9466 (rubber) (230 x 48 x 70)
KOBELCO SK17SR-5				
		REF 163TA9448 (number of teeth = 13) (number of holes = 8)		REF 163TA9447 (rubber) (230 x 72 x 47) (with rail)
KOBELCO SK20SR				
<i>S/P: PM05 - S/N: 05001 - and up</i>				
REF 144TA8585 (for rubber tracks) (Ø flange = 132,00 mm) (Ø body = 80,00 mm)		REF 144TA8219 (for rubber tracks) (number of teeth = 19) (number of holes = 12)		
KOBELCO SK20SR-2				
<i>S/P: PM05 - S/N: 05001 - and up</i>				
			REF 144TA8059 (front, with bracket assembly) (for rubber tracks)	
KOBELCO SK25SR				
REF 163TA9487 (Ø flange = 148,00 mm) (Ø body = 93,00 mm)	REF 163TA9500 (assembly) (Ø body = 75,00 mm)	REF 143TA9115 (number of teeth = 23) (number of holes = 9)	REF 164TA2136 (front, with bracket assembly)	REF 163TA9467 (rubber) (300 x 52,5 x 78) REF 163TA9475 (rubber) (300 x 109 x 38)

TRACKS & UNDERCARRIAGE PARTS



used for KOBELCO

used for KOBELCO				
TRACK ROLLER	TOP ROLLER	SPROCKET	IDLER	TRACK
				
KOBELCO SK25SR-2				
REF 163TA9488 (Ø flange = 132,00 mm) (Ø body = 80,00 mm)	REF 163TA9501 (assembly)	REF 143TA9043 (number of teeth = 19) (number of holes = 12)	REF 163TA9506 (front, with bracket assembly)	REF 143TA9682 (rubber) (250 x 52,5 x 76)
REF 144TA8589 (Ø flange = 132,00 mm) (Ø body = 80,00 mm)				
KOBELCO SK25SR-6E				
		REF 164TA9693 (for rubber tracks) (number of teeth = 21) (number of holes = 12)		REF 164TA3085 (rubber) (250 x 55,5 x 79)
KOBELCO SK26				
		REF 164TA9693 (for rubber tracks) (number of teeth = 21) (number of holes = 12)		REF 164TA3085 (rubber) (250 x 55,5 x 79)
KOBELCO SK27SR-3				
REF 143TA8567 (Ø flange = 108,00 mm) (Ø body = 85,00 mm)	REF 143TA8902 (assembly) (Ø body = 75,00 mm)	REF 143TA9043 (number of teeth = 19) (number of holes = 12)	REF 144TA7927 (front, with bracket assembly) (LH) (Ø = 346,00 mm) REF 163TA9507 (front, with bracket assembly) (RH)	REF 163TA9468 (rubber) (250 x 52,5 x 80)
KOBELCO SK30SR				
<i>S/P: PV - S/N: 03501 - 10105</i>				
REF 144TA8599 (for rubber tracks) (Ø flange = 148,00 mm) (Ø body = 93,00 mm)	REF 144TA8357 (assembly) (for rubber tracks) (Ø body = 75,00 mm)	REF 143TA9115 (for rubber tracks) (number of teeth = 23) (number of holes = 9)	REF 143TA9383 (front, with bracket assembly) (for rubber tracks)	REF 163TA9437 (rubber) (300 x 52,5 x 82) (with rail)
REF 144TA8593 (for rubber tracks) (Ø flange = 148,00 mm) (Ø body = 93,00 mm)	REF 144TA8351 (assembly) (for rubber tracks) (Ø body = 75,00 mm)	REF 144TA8225 (for rubber tracks) (number of teeth = 23) (number of holes = 9)		REF 139TA9589 (rubber) (300 x 109w x 40)
<i>S/P: PW - S/N: 07001 - 07012</i>				
REF 144TA8670 (for rubber tracks) (Ø flange = 148,00 mm) (Ø body = 93,00 mm)	REF 144TA8358 (assembly) (for rubber tracks) (Ø body = 75,00 mm)	REF 144TA8230 (for rubber tracks) (number of teeth = 23) (number of holes = 9)	REF 143TA9383 (front, with bracket assembly) (for rubber tracks)	REF 139TA9589 (rubber) (300 x 109w x 40)
REF 144TA8593 (for rubber tracks) (Ø flange = 148,00 mm) (Ø body = 93,00 mm)	REF 144TA8351 (assembly) (for rubber tracks) (Ø body = 75,00 mm)	REF 144TA8225 (for rubber tracks) (number of teeth = 23) (number of holes = 9)		
<i>S/P: PW - S/N: 07001 - and up</i>				
REF 144TA8593 (for rubber tracks) (Ø flange = 148,00 mm) (Ø body = 93,00 mm)	REF 144TA8351 (assembly) (for rubber tracks) (Ø body = 75,00 mm)	REF 144TA8225 (for rubber tracks) (number of teeth = 23) (number of holes = 9)		REF 163TA9437 (rubber) (300 x 52,5 x 82) (with rail)
				REF 139TA9589 (rubber) (300 x 109w x 40)
<i>S/P: PW - S/N: 07013 - 09500</i>				
REF 144TA8671 (for rubber tracks) (Ø flange = 148,00 mm) (Ø body = 93,00 mm)	REF 144TA8359 (assembly) (for rubber tracks) (Ø body = 75,00 mm)	REF 143TA9115 (for rubber tracks) (number of teeth = 23) (number of holes = 9)	REF 143TA9383 (front, with bracket assembly) (for rubber tracks)	REF 139TA9589 (rubber) (300 x 109w x 40)



used for KOBELCO				
TRACK ROLLER	TOP ROLLER	SPROCKET	IDLER	TRACK
				
REF 144TA8593 (for rubber tracks) (Ø flange = 148,00 mm) (Ø body = 93,00 mm)	REF 144TA8351 (assembly) (for rubber tracks) (Ø body = 75,00 mm)	REF 144TA8225 (for rubber tracks) (number of teeth = 23) (number of holes = 9)		
<i>S/P: PW - S/N: 09501 - and up</i>				
REF 144TA8672 (for rubber tracks) (Ø flange = 148,00 mm) (Ø body = 93,00 mm)	REF 144TA8360 (assembly) (for rubber tracks) (Ø body = 75,00 mm)	REF 143TA9115 (for rubber tracks) (number of teeth = 23) (number of holes = 9)	REF 143TA9383 (front, with bracket assembly) (for rubber tracks)	REF 139TA9589 (rubber) (300 x 109w x 82)
REF 144TA8593 (for rubber tracks) (Ø flange = 148,00 mm) (Ø body = 93,00 mm)	REF 144TA8351 (assembly) (for rubber tracks) (Ø body = 75,00 mm)	REF 144TA8225 (for rubber tracks) (number of teeth = 23) (number of holes = 9)		
KOBELCO SK30SR-2				
<i>S/P: PW08 - S/N: 20001 - and up</i>				
REF 144TA8595 (for rubber tracks) (Ø flange = 148,00 mm) (Ø body = 93,00 mm)	REF 144TA8353 (assembly) (for rubber tracks) (Ø body = 75,00 mm)	REF 144TA8226 (for rubber tracks) (number of teeth = 23) (number of holes = 9)	REF 144TA8063 (front, with bracket assembly) (for rubber tracks) (Ø = 345,00 mm)	REF 163TA9438 (rubber) (300 x 52,5 x 82) (with rail)
REF 144TA8594 (for rubber tracks) (Ø flange = 148,00 mm) (Ø body = 93,00 mm)	REF 144TA8352 (assembly) (for rubber tracks) (Ø body = 75,00 mm)	REF 143TA9115 (for rubber tracks) (number of teeth = 23) (number of holes = 9)		
<i>S/P: PW10 - S/N: 22001 - and up</i>				
REF 144TA8596 (for rubber tracks) (Ø flange = 148,00 mm) (Ø body = 93,00 mm)	REF 144TA8354 (assembly) (for rubber tracks) (Ø body = 75,00 mm)	REF 144TA8227 (for rubber tracks) (number of teeth = 23) (number of holes = 9)		REF 163TA9470 (rubber) (300 x 52,5 x 82)
REF 144TA8594 (for rubber tracks) (Ø flange = 148,00 mm) (Ø body = 93,00 mm)	REF 144TA8352 (assembly) (for rubber tracks) (Ø body = 75,00 mm)	REF 143TA9115 (for rubber tracks) (number of teeth = 23) (number of holes = 9)		
KOBELCO SK30SR-3				
<i>S/P: PW11 - S/N: 30001 - 32181</i>				
REF 144TA8598 (for rubber tracks) (Ø flange = 108,00 mm) (Ø body = 85,00 mm)	REF 144TA8356 (assembly) (for rubber tracks) (Ø body = 75,00 mm)	REF 144TA8229 (for rubber tracks) (number of teeth = 23) (number of holes = 9)	REF 144TA8064 (front, with bracket assembly) (for rubber tracks) (Ø = 345,00 mm)	REF 164TA3024 (rubber) (300 x 52,5 x 82)
REF 144TA8597 (for rubber tracks) (Ø flange = 108,00 mm) (Ø body = 85,00 mm)	REF 144TA8355 (assembly) (for rubber tracks) (Ø body = 75,00 mm)	REF 144TA8228 (for rubber tracks) (number of teeth = 23) (number of holes = 9)		
<i>S/P: PW12 - S/N: 40001 - and up</i>				
REF 144TA8597 (for rubber tracks) (Ø flange = 108,00 mm) (Ø body = 85,00 mm)	REF 144TA8355 (assembly) (for rubber tracks) (Ø body = 75,00 mm)	REF 144TA8228 (for rubber tracks) (number of teeth = 23) (number of holes = 9)		REF 164TA3024 (rubber) (300 x 52,5 x 82)
<i>S/P: PW13 - S/N: 42402 - and up</i>				
REF 144TA8597 (for rubber tracks) (Ø flange = 108,00 mm) (Ø body = 85,00 mm)	REF 144TA8355 (assembly) (for rubber tracks) (Ø body = 75,00 mm)	REF 144TA8228 (for rubber tracks) (number of teeth = 23) (number of holes = 9)		REF 164TA3024 (rubber) (300 x 52,5 x 82)



used for KOBELCO				
TRACK ROLLER	TOP ROLLER	SPROCKET	IDLER	TRACK
				
KOBELCO SK30UR				
<i>S/P: PR - S/N: up to - 01500</i>				
REF 144TA8601 (for rubber tracks) (Ø flange = 133,00 mm) (Ø body = 93,00 mm)	REF 144TA8362 (assembly) (for rubber tracks) (Ø body = 75,00 mm)	REF 144TA8232 (for rubber tracks) (number of teeth = 23) (number of holes = 9)	REF 144TA8066 (front, with bracket assembly) (for rubber tracks) (Ø = 346,00 mm)	REF 139TA9589 (rubber) (300 x 109w x 40)
KOBELCO SK30UR-2				
<i>S/P: PR - S/N: 01501 - and up</i>				
REF 144TA8600 (for rubber tracks) (Ø flange = 118,00 mm) (Ø body = 94,00 mm)	REF 144TA8361 (assembly) (for rubber tracks) (Ø body = 75,00 mm)	REF 144TA8231 (for rubber tracks) (number of teeth = 23) (number of holes = 9)	REF 144TA8065 (front, with bracket assembly) (for rubber tracks) (Ø = 346,00 mm)	REF 139TA9589 (rubber) (300 x 109w x 40)
KOBELCO SK35SR				
<i>S/P: PX - S/N: 05001 - 06500</i>				
REF 144TA8610 (for rubber tracks) (Ø flange = 148,00 mm) (Ø body = 93,00 mm)	REF 144TA8370 (assembly) (for rubber tracks) (Ø body = 75,00 mm)		REF 143TA9383 (front, with bracket assembly) (for rubber tracks)	
<i>S/P: PX - S/N: 05001 - and up</i>				
				REF 163TA9439 (rubber) (300 x 52,5 x 88) (with rail)
<i>S/P: PX - S/N: 06501 - and up</i>				
REF 144TA8611 (for rubber tracks) (Ø flange = 148,00 mm) (Ø body = 93,00 mm)	REF 144TA8371 (assembly) (for rubber tracks) (Ø body = 75,00 mm)	REF 143TA9116 (for rubber tracks)	REF 143TA9383 (front, with bracket assembly) (for rubber tracks)	
<i>S/P: PX08 - S/N: 06501 - and up</i>				
REF 144TA8609 (for rubber tracks) (Ø flange = 148,00 mm) (Ø body = 93,00 mm)	REF 144TA8369 (assembly) (for rubber tracks) (Ø body = 75,00 mm)	REF 143TA9116 (for rubber tracks)	REF 143TA9383 (front, with bracket assembly) (for rubber tracks)	REF 163TA9439 (rubber) (300 x 52,5 x 88) (with rail)
KOBELCO SK35SR-1				
REF 144TA8602 (for rubber tracks) (Ø flange = 138,00 mm) (Ø body = 86,00 mm)	REF 144TA8363 (assembly) (for rubber tracks) (Ø body = 75,00 mm)	REF 144TA1879 (for rubber tracks) (number of teeth = 23) (number of holes = 9)		REF 143TA9786 (rubber) (350 x 52,5 x 90)
REF 144TA8603 (for rubber tracks) (Ø flange = 148,00 mm) (Ø body = 93,00 mm)				
KOBELCO SK35SR-2				
<i>S/P: PX09 - S/N: 08001 - and up</i>				
REF 144TA8605 (for rubber tracks) (Ø flange = 148,00 mm) (Ø body = 93,00 mm)	REF 144TA8365 (assembly) (for rubber tracks) (Ø body = 75,00 mm)	REF 144TA8234 (for rubber tracks) (number of teeth = 23) (number of holes = 9)	REF 144TA8067 (front, with bracket assembly) (for rubber tracks) (Ø = 345,00 mm)	REF 163TA9439 (rubber) (300 x 52,5 x 88) (with rail)
REF 144TA8604 (for rubber tracks) (Ø flange = 148,00 mm) (Ø body = 93,00 mm)	REF 144TA8364 (assembly) (for rubber tracks) (Ø body = 75,00 mm)	REF 144TA8233 (for rubber tracks) (number of teeth = 23) (number of holes = 9)		
<i>S/P: PX11 - S/N: 08901 - and up</i>				
REF 144TA8606 (for rubber tracks) (Ø flange = 148,00 mm) (Ø body = 93,00 mm)	REF 144TA8366 (assembly) (for rubber tracks) (Ø body = 75,00 mm)	REF 144TA8235 (for rubber tracks) (number of teeth = 23) (number of holes = 9)	REF 144TA8068 (front, with bracket assembly) (for rubber tracks) (Ø = 345,00 mm)	REF 163TA9439 (rubber) (300 x 52,5 x 88) (with rail)



used for KOBELCO				
TRACK ROLLER	TOP ROLLER	SPROCKET	IDLER	TRACK
				
REF 144TA8604 (for rubber tracks) (Ø flange = 148,00 mm) (Ø body = 93,00 mm)	REF 144TA8364 (assembly) (for rubber tracks) (Ø body = 75,00 mm)	REF 144TA8233 (for rubber tracks) (number of teeth = 23) (number of holes = 9)		
KOBELCO SK35SR-3				
<i>S/P: PV11 - S/N: 30001 - and up</i>				
REF 144TA8607 (for rubber tracks) (Ø flange = 108,00 mm) (Ø body = 85,00 mm)	REF 144TA8367 (assembly) (for rubber tracks) (Ø body = 75,00 mm)	REF 144TA8236 (for rubber tracks) (number of teeth = 23) (number of holes = 9)		REF 163TA9470 (rubber) (300 x 52,5 x 88)
<i>S/P: PX12 - S/N: 11001 - 12803</i>				
REF 144TA8608 (for rubber tracks) (Ø flange = 108,00 mm) (Ø body = 85,00 mm)	REF 144TA8368 (assembly) (for rubber tracks) (Ø body = 75,00 mm)	REF 144TA8237 (for rubber tracks) (number of teeth = 23) (number of holes = 9)	REF 144TA8069 (front, with bracket assembly) (for rubber tracks)	REF 163TA9470 (rubber) (300 x 52,5 x 88)
REF 144TA8607 (for rubber tracks) (Ø flange = 108,00 mm) (Ø body = 85,00 mm)	REF 144TA8367 (assembly) (for rubber tracks) (Ø body = 75,00 mm)	REF 144TA8236 (for rubber tracks) (number of teeth = 23) (number of holes = 9)		
<i>S/P: PX13 - S/N: 15001 - and up</i>				
REF 144TA8607 (for rubber tracks) (Ø flange = 108,00 mm) (Ø body = 85,00 mm)	REF 144TA8367 (assembly) (for rubber tracks) (Ø body = 75,00 mm)	REF 144TA8236 (for rubber tracks) (number of teeth = 23) (number of holes = 9)		REF 163TA9470 (rubber) (300 x 52,5 x 88)
<i>S/P: PX14 - S/N: 17001 - and up</i>				
REF 144TA8607 (for rubber tracks) (Ø flange = 108,00 mm) (Ø body = 85,00 mm)	REF 144TA8367 (assembly) (for rubber tracks) (Ø body = 75,00 mm)	REF 144TA8236 (for rubber tracks) (number of teeth = 23) (number of holes = 9)		REF 163TA9470 (rubber) (300 x 52,5 x 88)
KOBELCO SK35SR-5				
<i>S/P: PX15 - S/N: 20658 - and up</i>				
				REF 163TA9470 (rubber) (300 x 52,5 x 88)
KOBELCO SK40SR				
<i>S/P: PH - S/N: 00101 - and up</i>				
REF 144TA8616 (for rubber tracks) (Ø flange = 150,00 mm) (Ø body = 94,00 mm)	REF 144TA8376 (assembly) (for rubber tracks) (Ø body = 75,00 mm)	REF 143TA9117 (for rubber tracks)		REF 164TA3030 (rubber) (400 x 72,5 x 72)
REF 144TA8612 (for rubber tracks) (Ø flange = 150,00 mm) (Ø body = 94,00 mm)	REF 144TA8372 (assembly) (for rubber tracks) (Ø body = 88,00 mm)	REF 144TA8238 (for rubber tracks) (number of teeth = 19) (number of holes = 12)		
REF 144TA8615 (for rubber tracks) (Ø flange = 150,00 mm) (Ø body = 94,00 mm)				
<i>S/P: PH04 - S/N: 02801 - and up</i>				
REF 144TA8615 (for rubber tracks) (Ø flange = 150,00 mm) (Ø body = 94,00 mm)	REF 144TA8375 (assembly) (for rubber tracks) (Ø body = 88,00 mm)	REF 144TA8241 (for rubber tracks) (number of teeth = 19) (number of holes = 12)	REF 144TA8071 (front, with bracket assembly) (for rubber tracks)	REF 164TA3030 (rubber) (400 x 72,5 x 72)
REF 144TA8612 (for rubber tracks) (Ø flange = 150,00 mm) (Ø body = 94,00 mm)	REF 144TA8372 (assembly) (for rubber tracks) (Ø body = 88,00 mm)	REF 144TA8238 (for rubber tracks) (number of teeth = 19) (number of holes = 12)		





used for KOBELCO				
TRACK ROLLER	TOP ROLLER	SPROCKET	IDLER	TRACK
				
KOBELCO SK40SR-2				
REF 144TA8613 (for rubber tracks) (Ø flange = 150,00 mm) (Ø body = 94,00 mm)	REF 144TA8373 (assembly) (for rubber tracks) (Ø body = 88,00 mm)	REF 144TA8239 (for rubber tracks) (number of teeth = 19) (number of holes = 12)		REF 164TA3030 (rubber) (400 x 72,5 x 72)
KOBELCO SK40SR-3				
REF 144TA8614 (for rubber tracks) (Ø flange = 130,00 mm) (Ø body = 100,00 mm)	REF 144TA8374 (assembly) (for rubber tracks) (Ø body = 88,00 mm)	REF 144TA8240 (for rubber tracks) (number of teeth = 19) (number of holes = 12)	REF 144TA8070 (front, with bracket assembly) (for rubber tracks) (Ø = 362,00 mm)	REF 143TA9754 (rubber) (400 x 72,5 x 72)
KOBELCO SK45SR				
<i>S/P: PY - S/N: 06001 - 07100</i>				
REF 144TA8621 (for rubber tracks) (Ø flange = 150,00 mm) (Ø body = 94,00 mm)	REF 144TA8381 (assembly) (for rubber tracks) (Ø body = 88,00 mm)	REF 144TA8246 (for rubber tracks)	REF 144TA8076 (front, with bracket assembly) (for rubber tracks)	
<i>S/P: PY - S/N: 06001 - and up</i>				
				REF 143TA9787 (rubber) (400 x 72,5 x 74)
<i>S/P: PY - S/N: 07101 - and up</i>				
REF 144TA8622 (for rubber tracks) (Ø flange = 150,00 mm) (Ø body = 94,00 mm)	REF 144TA8382 (assembly) (for rubber tracks) (Ø body = 88,00 mm)	REF 144TA8247 (for rubber tracks)	REF 144TA8077 (front, with bracket assembly) (for rubber tracks)	
KOBELCO SK45SR-2				
<i>S/P: PJ02 - S/N: 00101 - and up</i>				
REF 144TA8619 (for rubber tracks) (Ø flange = 150,00 mm) (Ø body = 94,00 mm)	REF 144TA8379 (assembly) (for rubber tracks) (Ø body = 88,00 mm)	REF 144TA8244 (for rubber tracks) (number of teeth = 19) (number of holes = 12)	REF 144TA8074 (front, with bracket assembly) (for rubber tracks)	REF 143TA9787 (rubber) (400 x 72,5 x 74)
REF 144TA8617 (for rubber tracks) (Ø flange = 150,00 mm) (Ø body = 94,00 mm)	REF 144TA8377 (assembly) (for rubber tracks) (Ø body = 88,00 mm)	REF 144TA8242 (for rubber tracks) (number of teeth = 19) (number of holes = 12)	REF 144TA8072 (front, with bracket assembly) (for rubber tracks)	REF 139TA9637 (rubber) (400 x 72,5 x 72)
<i>S/P: PJ03 - S/N: 01001 - and up</i>				
REF 144TA8620 (for rubber tracks) (Ø flange = 150,00 mm) (Ø body = 94,00 mm)	REF 144TA8380 (assembly) (for rubber tracks) (Ø body = 88,00 mm)	REF 144TA8245 (for rubber tracks) (number of teeth = 19) (number of holes = 12)	REF 144TA8075 (front, with bracket assembly) (for rubber tracks)	REF 143TA9787 (rubber) (400 x 72,5 x 74)
REF 144TA8617 (for rubber tracks) (Ø flange = 150,00 mm) (Ø body = 94,00 mm)	REF 144TA8377 (assembly) (for rubber tracks) (Ø body = 88,00 mm)	REF 144TA8242 (for rubber tracks) (number of teeth = 19) (number of holes = 12)	REF 144TA8072 (front, with bracket assembly) (for rubber tracks)	REF 139TA9637 (rubber) (400 x 72,5 x 72)
KOBELCO SK45SR-2(Global)				
<i>S/P: PJ03 - S/N: 01001 - and up</i>				
REF 144TA8618 (for rubber tracks) (Ø flange = 150,00 mm) (Ø body = 94,00 mm)	REF 144TA8378 (assembly) (for rubber tracks) (Ø body = 88,00 mm)	REF 144TA8243 (for rubber tracks) (number of teeth = 19) (number of holes = 12)	REF 144TA8073 (front, with bracket assembly) (for rubber tracks)	REF 143TA9787 (rubber) (400 x 72,5 x 74)
KOBELCO SK50SR				
		REF 144TA8248 (for rubber tracks) (number of teeth = 19) (number of holes = 12)		REF 143TA9754 (rubber) (400 x 72,5 x 72)

TRACKS & UNDERCARRIAGE PARTS



used for KOBELCO





used for KOBELCO				
TRACK ROLLER	TOP ROLLER	SPROCKET	IDLER	TRACK
				
KOBELCO SK50SR-3				
<i>S/P: PJ04 - S/N: 03001 - and up</i>				
REF 144TA8624 (for rubber tracks) (Ø flange = 130,00 mm) (Ø body = 100,00 mm)	REF 144TA8384 (assembly) (for rubber tracks) (Ø body = 88,00 mm)	REF 144TA8250 (for rubber tracks) (number of teeth = 19) (number of holes = 12)	REF 144TA8079 (front, with bracket assembly) (for rubber tracks) (Ø = 362,00 mm)	REF 143TA9754 (rubber) (400 x 72,5 x 72)
REF 144TA8623 (for rubber tracks) (Ø flange = 130,00 mm) (Ø body = 100,00 mm)	REF 144TA8383 (assembly) (for rubber tracks) (Ø body = 88,00 mm)	REF 144TA8249 (for rubber tracks) (number of teeth = 19) (number of holes = 12)	REF 144TA8078 (front, with bracket assembly) (for rubber tracks) (Ø = 362,00 mm)	
KOBELCO SK50SR-5				
REF 144TA8625 (for rubber tracks) (Ø flange = 130,00 mm) (Ø body = 100,00 mm)	REF 144TA8385 (assembly) (for rubber tracks) (Ø body = 88,00 mm)	REF 144TA8251 (for rubber tracks) (number of teeth = 19) (number of holes = 12)	REF 144TA8080 (front, with bracket assembly) (for rubber tracks)	REF 143TA9754 (rubber) (400 x 72,5 x 72)
KOBELCO SK50UR				
<i>S/P: YJ - S/N: 00101 - 02316</i>				
REF 144TA8631 (for rubber tracks) (Ø flange = 205,00 mm) (Ø body = 100,00 mm)	REF 144TA8390 (assembly) (for rubber tracks) (Ø body = 88,00 mm)	REF 144TA8255 (for rubber tracks)	REF 144TA8085 (front, with bracket assembly) (for rubber tracks)	REF 143TA9754 (rubber) (400 x 72,5 x 72)
KOBELCO SK50UR-1				
REF 144TA8626 (for rubber tracks) (Ø flange = 205,00 mm) (Ø body = 100,00 mm)			REF 144TA8081 (front, with bracket assembly) (for rubber tracks)	REF 143TA9754 (rubber) (400 x 72,5 x 72)
KOBELCO SK50UR-2				
<i>S/P: YJ - S/N: 02501 - 03328</i>				
REF 144TA8628 (for rubber tracks) (Ø flange = 130,00 mm) (Ø body = 100,00 mm)	REF 144TA8387 (assembly) (for rubber tracks) (Ø body = 88,00 mm)	REF 144TA8252 (for rubber tracks)	REF 144TA8082 (front, with bracket assembly) (for rubber tracks)	REF 143TA9754 (rubber) (400 x 72,5 x 72)
REF 144TA8627 (for rubber tracks) (Ø flange = 130,00 mm) (Ø body = 100,00 mm)	REF 144TA8386 (assembly) (for rubber tracks) (Ø body = 80,00 mm)			
<i>S/P: YJ - S/N: 04001 - and up</i>				
REF 144TA8629 (for rubber tracks) (Ø flange = 130,00 mm) (Ø body = 100,00 mm)	REF 144TA8388 (assembly) (for rubber tracks) (Ø body = 88,00 mm)	REF 144TA8253 (for rubber tracks)	REF 144TA8083 (front, with bracket assembly) (for rubber tracks)	REF 143TA9754 (rubber) (400 x 72,5 x 72)
REF 144TA8627 (for rubber tracks) (Ø flange = 130,00 mm) (Ø body = 100,00 mm)	REF 144TA8386 (assembly) (for rubber tracks) (Ø body = 80,00 mm)			
KOBELCO SK50UR-3				
REF 144TA8630 (for steel tracks) (Ø flange = 150,00 mm) (Ø body = 94,00 mm)	REF 144TA8389 (assembly) (for steel tracks) (Ø body = 88,00 mm)	REF 144TA8254 (for steel tracks) (number of teeth = 19) (number of holes = 12)	REF 144TA8084 (front, with bracket assembly) (for steel tracks)	
KOBELCO SK60(MARKIII)				
	REF 144TA8391 (assembly) (for rubber tracks) (Ø body = 88,00 mm)	REF 144TA7928 (for rubber tracks)	REF 144TA7929 (front, with bracket assembly) (for rubber tracks)	REF 143TA9789 (rubber) (450 x 81,5 x 74)
KOBELCO SK60(MARKIV)				
	REF 144TA8392 (assembly) (for rubber tracks) (Ø body = 88,00 mm)	REF 144TA7928 (for rubber tracks)	REF 144TA7929 (front, with bracket assembly) (for rubber tracks)	REF 143TA9789 (rubber) (450 x 81,5 x 74)



used for KOBELCO				
TRACK ROLLER	TOP ROLLER	SPROCKET	IDLER	TRACK
				
KOBELCO SK60(MARKV)				
<i>S/N: LE017701 - LE018838</i>				
REF 163TA9499 (for steel tracks) (Ø flange = 154,00 mm) (Ø body = 120,00 mm)	REF 163TA9504 (assembly) (Ø body = 88,00 mm)	REF 144TA7928	REF 144TA7929 (front, with bracket assembly)	REF 164TA2036 (rubber) (450 x 81,5 x 74)
REF 163TA9497 (for rubber tracks) (double guide)				
REF 163TA9498 (for rubber tracks) (outer guide)				
<i>S/N: LE018839 - and up</i>				
REF 164TA1016 (for steel tracks)	REF 163TA9504 (assembly) (Ø body = 88,00 mm)	REF 144TA7928	REF 144TA7929 (front, with bracket assembly)	REF 164TA2036 (rubber) (450 x 81,5 x 74)
REF 163TA9497 (for rubber tracks) (double guide)				
REF 163TA9498 (for rubber tracks) (outer guide)				
KOBELCO SK60SR				
<i>S/P: YT01 - S/N: 00101 - and up</i>				
REF 144TA7930 (for rubber tracks) (Ø flange = 154,00 mm) (Ø body = 120,00 mm)	REF 144TA8395 (assembly) (for rubber tracks) (Ø body = 88,00 mm)	REF 144TA7928 (for rubber tracks)	REF 144TA7929 (front, with bracket assembly) (for rubber tracks)	REF 143TA9789 (rubber) (450 x 81,5 x 74)
<i>S/P: YT02 - S/N: 04001 - and up</i>				
REF 144TA7930 (for rubber tracks) (Ø flange = 154,00 mm) (Ø body = 120,00 mm)				REF 143TA9789 (rubber) (450 x 81,5 x 74)
KOBELCO SK60SR-1				
<i>S/P: EYT02 - S/N: 04001 - and up</i>				
	REF 144TA8394 (assembly) (for rubber tracks) (Ø body = 82,00 mm)	REF 144TA7928 (for rubber tracks)	REF 144TA7929 (front, with bracket assembly) (for rubber tracks)	REF 143TA9789 (rubber) (450 x 81,5 x 74)
KOBELCO SK70SR				
REF 144TA7930 (for rubber tracks) (Ø flange = 154,00 mm) (Ø body = 120,00 mm)	REF 144TA8396 (assembly) (for rubber tracks) (Ø body = 82,00 mm)	REF 144TA7928 (for rubber tracks)	REF 144TA7929 (front, with bracket assembly) (for rubber tracks)	REF 143TA9769 (rubber) (450 x 81,5 x 74)
KOBELCO SK70SR-1				
<i>S/P: E</i>				
REF 144TA7930 (for rubber tracks) (Ø flange = 154,00 mm) (Ø body = 120,00 mm)	REF 144TA8398 (assembly) (for rubber tracks) (Ø body = 82,00 mm)	REF 144TA7928 (for rubber tracks)	REF 144TA7929 (front, with bracket assembly) (for rubber tracks)	REF 143TA9769 (rubber) (450 x 81,5 x 74)
KOBELCO SK75UR				
REF 144TA7930 (for rubber tracks) (Ø flange = 154,00 mm) (Ø body = 120,00 mm)	REF 144TA8399 (assembly) (for rubber tracks) (Ø body = 82,00 mm)	REF 144TA7928 (for rubber tracks)	REF 144TA7929 (front, with bracket assembly) (for rubber tracks)	REF 143TA9789 (rubber) (450 x 81,5 x 74)
KOBELCO SK80CS				
REF 144TA7930 (for rubber tracks) (Ø flange = 154,00 mm) (Ø body = 120,00 mm)	REF 144TA8400 (assembly) (for rubber tracks) (Ø body = 82,00 mm)	REF 144TA7928 (for rubber tracks)	REF 144TA7929 (front, with bracket assembly) (for rubber tracks)	REF 143TA9769 (rubber) (450 x 81,5 x 74)
KOBELCO SK80MSR				
REF 144TA7930 (for rubber tracks) (Ø flange = 154,00 mm) (Ø body = 120,00 mm)	REF 144TA8401 (assembly) (for rubber tracks) (Ø body = 82,00 mm)	REF 144TA7928 (for rubber tracks)	REF 144TA7929 (front, with bracket assembly) (for rubber tracks)	REF 143TA9769 (rubber) (450 x 81,5 x 74)



used for KOBELCO

used for KOBELCO				
TRACK ROLLER	TOP ROLLER	SPROCKET	IDLER	TRACK
				
KOBELCO SK80MSR-1				
<i>S/P: E</i>				
REF 144TA7930 (for rubber tracks) (∅ flange = 154,00 mm) (∅ body = 120,00 mm)	REF 144TA8403 (assembly) (for rubber tracks) (∅ body = 82,00 mm)	REF 144TA7928 (for rubber tracks)	REF 144TA7929 (front, with bracket assembly) (for rubber tracks)	REF 143TA9769 (rubber) (450 x 81,5 x 76)
KOBELCO SK95UR				
<i>S/P: YX</i>				
REF 144TA7930 (for rubber tracks) (∅ flange = 154,00 mm) (∅ body = 120,00 mm)	REF 144TA8404 (assembly) (for rubber tracks) (∅ body = 82,00 mm)	REF 144TA7928 (for rubber tracks)	REF 144TA7929 (front, with bracket assembly) (for rubber tracks)	REF 143TA9739 (rubber) (450 x 81 x 78)







USED FOR
KOMATSU

TRACKS & UNDERCARRIAGE PARTS







used for KOMATSU

used for KOMATSU				
TRACK ROLLER	TOP ROLLER	SPROCKET	IDLER	TRACK
				
KOMATSU CD10R-1				
<i>S/N: 01027 - 01086</i>				
REF 143TA8859 (outer guide)	REF 143TA8929 (assembly)	REF 143TA9119	REF 143TA9388 (front, with bracket assembly)	REF 143TA9790 (rubber)
REF 143TA8880 (double guide)				
<i>S/N: 01087 - and up</i>				
REF 143TA8860 (outer guide)	REF 143TA8930 (assembly)	REF 143TA9119	REF 143TA9389 (front, with bracket assembly)	REF 143TA9790 (rubber)
REF 143TA8881 (double guide)				
KOMATSU CD110R-1				
<i>S/N: 01061 - 01157</i>				
		REF 143TA9120	REF 143TA9390 (front, with bracket assembly) (Ø = 582,00 mm)	REF 143TA9791 (rubber) (800 x 150 x 67)
<i>S/N: 01061 - 01172</i>				
	REF 143TA8679 (assembly)	REF 143TA9120	REF 143TA9390 (front, with bracket assembly) (Ø = 582,00 mm)	
<i>S/N: 01061 - 01254</i>				
REF 143TA8931		REF 143TA9120	REF 143TA9390 (front, with bracket assembly) (Ø = 582,00 mm)	
<i>S/N: 01158 - 01188</i>				
		REF 143TA9120	REF 143TA9390 (front, with bracket assembly) (Ø = 582,00 mm)	REF 143TA9792 (rubber) (800 x 150 x 67)
<i>S/N: 01173 - 01254</i>				
	REF 163TA9551 (assembly)	REF 143TA9120	REF 143TA9390 (front, with bracket assembly) (Ø = 582,00 mm)	
<i>S/N: 01189 - 01254</i>				
		REF 143TA9120	REF 143TA9390 (front, with bracket assembly) (Ø = 582,00 mm)	REF 143TA9793 (rubber) (800 x 150 x 67)
<i>S/N: 01255 - and up</i>				
REF 143TA8932	REF 143TA8680 (assembly)	REF 143TA9120	REF 143TA9390 (front, with bracket assembly) (Ø = 582,00 mm)	REF 143TA9794 (rubber) (800 x 150 x 67)
KOMATSU CD20R-1				
REF 143TA8934	REF 143TA8682 (assembly)	REF 143TA9122	REF 143TA9392 (front, with bracket assembly)	REF 143TA9796 (rubber) (width = 320,00 mm)
KOMATSU CD30R-1C				
<i>S/N: 01061 - 01162</i>				
REF 143TA8935		REF 143TA9123	REF 143TA9393 (front, with bracket assembly)	REF 144TA1025 (rubber) (width = 320,00 mm) REF 144TA1026 (rubber) (width = 380,00 mm) REF 144TA1027 (rubber) (width = 450,00 mm)

TRACKS & UNDERCARRIAGE PARTS







used for KOMATSU





used for KOMATSU				
TRACK ROLLER	TOP ROLLER	SPROCKET	IDLER	TRACK
				
<i>S/N: 01061 - 01312</i>				
REF 143TA8935	REF 143TA8683 (assembly)	REF 143TA9123		REF 144TA1025 (rubber) (width = 320,00 mm) REF 144TA1026 (rubber) (width = 380,00 mm) REF 144TA1027 (rubber) (width = 450,00 mm)
<i>S/N: 01163 - and up</i>				
REF 143TA8935		REF 143TA9123	REF 143TA9392 (front, with bracket assembly)	REF 144TA1025 (rubber) (width = 320,00 mm) REF 144TA1026 (rubber) (width = 380,00 mm) REF 144TA1027 (rubber) (width = 450,00 mm)
<i>S/N: 01313 - 01399</i>				
REF 143TA8935	REF 143TA8684 (assembly)	REF 143TA9123		REF 144TA1025 (rubber) (width = 320,00 mm) REF 144TA1026 (rubber) (width = 380,00 mm) REF 144TA1027 (rubber) (width = 450,00 mm)
<i>S/N: 01400 - and up</i>				
REF 143TA8935	REF 143TA8682 (assembly)	REF 143TA9123		REF 144TA1025 (rubber) (width = 320,00 mm) REF 144TA1026 (rubber) (width = 380,00 mm) REF 144TA1027 (rubber) (width = 450,00 mm)
KOMATSU CD30R-1R				
<i>S/N: 01061 - 01162</i>				
REF 143TA8935		REF 143TA9123	REF 143TA9393 (front, with bracket assembly)	REF 144TA1025 (rubber) (width = 320,00 mm) REF 144TA1026 (rubber) (width = 380,00 mm) REF 144TA1027 (rubber) (width = 450,00 mm)
<i>S/N: 01061 - 01312</i>				
REF 143TA8935	REF 143TA8683 (assembly)	REF 143TA9123		REF 144TA1025 (rubber) (width = 320,00 mm) REF 144TA1026 (rubber) (width = 380,00 mm) REF 144TA1027 (rubber) (width = 450,00 mm)
<i>S/N: 01163 - and up</i>				
REF 143TA8935		REF 143TA9123	REF 143TA9392 (front, with bracket assembly)	REF 144TA1025 (rubber) (width = 320,00 mm) REF 144TA1026 (rubber) (width = 380,00 mm) REF 144TA1027 (rubber) (width = 450,00 mm)
<i>S/N: 01313 - 01399</i>				
REF 143TA8935	REF 143TA8684 (assembly)	REF 143TA9123		REF 144TA1025 (rubber) (width = 320,00 mm)



used for KOMATSU





used for KOMATSU				
TRACK ROLLER	TOP ROLLER	SPROCKET	IDLER	TRACK
				
				REF 144TA1026 (rubber) (width = 380,00 mm) REF 144TA1027 (rubber) (width = 450,00 mm)
<i>S/N: 01400 - and up</i>				
REF 143TA8935	REF 143TA8682 (assembly)	REF 143TA9123		REF 144TA1025 (rubber) (width = 320,00 mm) REF 144TA1026 (rubber) (width = 380,00 mm) REF 144TA1027 (rubber) (width = 450,00 mm)
KOMATSU CD60R-1A				
<i>S/N: 01033 - 01957</i>				
REF 143TA8936		REF 143TA9124	REF 163TA9554 (front, with bracket assembly) (LH) REF 163TA9555 (front, with bracket assembly) (RH)	REF 143TA9797 (rubber) (600 x 100 x 82)
<i>S/N: 01666 - 01957</i>				
	REF 164TA2120 (assembly) REF 163TA9552 (assembly)			
<i>S/N: 01958 - and up</i>				
REF 143TA8937	REF 143TA8685 (assembly) (with center guard) (Ø flange = 270,00 mm) REF 163TA9553 (assembly) (without center guard)	REF 143TA9124		REF 143TA9797 (rubber) (600 x 100 x 82)
<i>S/N: 01985 - and up</i>				
			REF 143TA9395 (front, with bracket assembly)	
KOMATSU CD60R-1B				
<i>S/N: 01033 - 01216</i>				
REF 143TA8938 (Ø flange = 82,00 mm) (Ø body = 35,00 mm)				REF 144TA1028 (rubber) (width = 450,00 mm) (road liner)
<i>S/N: 01033 - 01386</i>				
			REF 143TA9396 (front, with bracket assembly) (Ø = 458,00 mm)	REF 144TA1028 (rubber) (width = 450,00 mm) (road liner)
<i>S/N: 01033 - 01529</i>				
	REF 143TA8882 (assembly) (Ø flange = 156,00 mm) (Ø body = 135,00 mm)			REF 144TA1029 (rubber) (width = 600,00 mm) (road liner) REF 144TA1028 (rubber) (width = 450,00 mm) (road liner)



used for KOMATSU				
TRACK ROLLER	TOP ROLLER	SPROCKET	IDLER	TRACK
				
S/N: 01033 - 01635		REF 143TA9125		REF 144TA1028 (rubber) (width = 450,00 mm) (road liner)
S/N: 01217 - 01418				
REF 143TA8939 (Ø flange = 80,00 mm) (Ø body = 35,00 mm)				
S/N: 01387 - and up			REF 143TA9397 (front, with bracket assembly) (Ø = 458,00 mm)	
S/N: 01419 - 01535				
REF 143TA8938 (Ø flange = 82,00 mm) (Ø body = 35,00 mm)				
S/N: 01530 - 01635				REF 144TA1031 (rubber) (width = 600,00 mm) (road liner)
S/N: 01530 - 01665		REF 143TA8883 (assembly) (Ø flange = 156,00 mm) (Ø body = 135,00 mm)		
S/N: 01536 - and up				
REF 143TA8940				
S/N: 01636 - 01950				
		REF 143TA9126		REF 144TA1032 (rubber) (width = 600,00 mm) (road liner)
S/N: 01666 - 02022		REF 143TA8884 (assembly) (Ø flange = 156,00 mm) (Ø body = 135,00 mm)		
S/N: 01951 - and up				REF 144TA1033 (rubber) (width = 600,00 mm) (road liner)
S/N: 02023 - and up		REF 143TA8885 (assembly) (Ø flange = 156,00 mm) (Ø body = 135,00 mm)		
KOMATSU CK20-1				
S/N: F00003 - F00035				
		REF 143TA9127	REF 143TA9600 (front, with bracket assembly) (single) REF 143TA9571 (front, with bracket assembly) (double)	REF 163TA9518 (rubber) (320 x 86 x 52)



used for KOMATSU

used for KOMATSU				
TRACK ROLLER	TOP ROLLER	SPROCKET	IDLER	TRACK
				
<i>S/N: F00003 - F00200</i>				
REF 143TA8866 (outer guide) (∅ flange = 200,00 mm)			REF 143TA9571 (front, with bracket assembly) (double)	REF 163TA9518 (rubber) (320 x 86 x 52)
REF 143TA8886 (double guide)				
<i>S/N: F00036 - and up</i>				
		REF 143TA9128	REF 143TA9571 (front, with bracket assembly) (double)	REF 163TA9518 (rubber) (320 x 86 x 52)
<i>S/N: F00036 - F00200</i>				
			REF 143TA9601 (front, with bracket assembly) (single)	REF 163TA9518 (rubber) (320 x 86 x 52)
			REF 143TA9571 (front, with bracket assembly) (double)	
<i>S/N: F00201 - and up</i>				
REF 143TA8867 (outer guide) (∅ flange = 200,00 mm)			REF 143TA9599 (front, with bracket assembly) (single)	REF 163TA9518 (rubber) (320 x 86 x 52)
REF 143TA8887 (double guide)			REF 143TA9571 (front, with bracket assembly) (double)	
KOMATSU CK25-1				
<i>S/N: F00003 - F00006</i>				
		REF 143TA9127	REF 143TA9600 (front, with bracket assembly) (single)	REF 163TA9518 (rubber) (320 x 86 x 52)
			REF 143TA9571 (front, with bracket assembly) (double)	
<i>S/N: F00003 - F00043</i>				
REF 143TA8866 (outer guide) (∅ flange = 200,00 mm)			REF 143TA9571 (front, with bracket assembly) (double)	REF 163TA9518 (rubber) (320 x 86 x 52)
REF 143TA8886 (double guide)				
<i>S/N: F00007 - and up</i>				
		REF 143TA9128	REF 143TA9571 (front, with bracket assembly) (double)	REF 163TA9518 (rubber) (320 x 86 x 52)
<i>S/N: F00007 - F00043</i>				
			REF 143TA9601 (front, with bracket assembly) (single)	REF 163TA9518 (rubber) (320 x 86 x 52)
			REF 143TA9571 (front, with bracket assembly) (double)	
<i>S/N: F00044 - and up</i>				
REF 143TA8867 (outer guide) (∅ flange = 200,00 mm)			REF 143TA9599 (front, with bracket assembly) (single)	REF 163TA9518 (rubber) (320 x 86 x 52)



used for KOMATSU				
TRACK ROLLER	TOP ROLLER	SPROCKET	IDLER	TRACK
				
REF 143TA8887 (double guide)			REF 143TA9571 (front, with bracket assembly) (double)	
KOMATSU CK30-1				
<i>S/N: A30001 - and up</i>				
REF 143TA8866 (outer guide) (Ø flange = 200,00 mm)		REF 143TA9129 (number of teeth = 17) (number of holes = 12)	REF 143TA9602 (front, with bracket assembly) (rear)	REF 144TA1035 (rubber) (320 x 86 x 56)
REF 143TA8886 (double guide)			REF 143TA9571 (front, with bracket assembly)	REF 144TA1034 (rubber) (450 x 86 x 56)
<i>S/N: F00127 - and up</i>				
REF 143TA8867 (outer guide) (Ø flange = 200,00 mm)		REF 143TA9129 (number of teeth = 17) (number of holes = 12)	REF 143TA9599 (front, with bracket assembly) (rear)	REF 144TA1035 (rubber) (320 x 86 x 56)
REF 143TA8887 (double guide)			REF 143TA9571 (front, with bracket assembly)	REF 144TA1034 (rubber) (450 x 86 x 56)
KOMATSU CK35-1				
<i>S/N: A40001 - and up</i>				
REF 143TA8866 (outer guide) (Ø flange = 200,00 mm)		REF 143TA9129 (number of teeth = 17) (number of holes = 12)	REF 143TA9602 (front, with bracket assembly) (rear)	REF 144TA1035 (rubber) (320 x 86 x 56)
REF 143TA8886 (double guide)			REF 143TA9571 (front, with bracket assembly)	REF 144TA1034 (rubber) (450 x 86 x 56)
<i>S/N: F00030 - and up</i>				
REF 143TA8867 (outer guide) (Ø flange = 200,00 mm)		REF 143TA9129 (number of teeth = 17) (number of holes = 12)	REF 143TA9599 (front, with bracket assembly) (rear)	REF 144TA1035 (rubber) (320 x 86 x 56)
REF 143TA8887 (double guide)			REF 143TA9571 (front, with bracket assembly)	REF 144TA1034 (rubber) (450 x 86 x 56)
KOMATSU PC01-1				
<i>S/N: 10001 - 14475</i>				
		REF 143TA9130	REF 143TA9398 (front, with bracket assembly)	REF 143TA9798 (rubber) (150 x 72 x 28)
<i>S/N: 14476 - and up</i>				
		REF 143TA9130	REF 143TA9399 (front, with bracket assembly)	REF 143TA9798 (rubber) (150 x 72 x 28)
KOMATSU PC01-1A				
REF 143TA8687		REF 143TA9130	REF 143TA9398 (front, with bracket assembly)	REF 143TA9798 (rubber) (150 x 72 x 28)
KOMATSU PC02-1				
REF 143TA8688		REF 143TA9131	REF 143TA9400 (front, with bracket assembly)	REF 143TA9799 (rubber) (150 x 72 x 33)
KOMATSU PC02-1A				
REF 143TA8688		REF 143TA9131	REF 143TA9400 (front, with bracket assembly)	REF 143TA9799 (rubber) (150 x 72 x 33)
KOMATSU PC03-1				
REF 143TA8689		REF 143TA9132	REF 143TA9401 (front, with bracket assembly)	REF 143TA9800 (rubber) (180 x 72 x 37)
KOMATSU PC03-2				
REF 143TA8691		REF 143TA9133 (number of teeth = 12) (number of holes = 9)	REF 143TA9402 (front, with bracket assembly) (Ø = 246,00 mm)	REF 164TA2037 (rubber) (180 x 72 x 37) (colored)



used for KOMATSU				
TRACK ROLLER	TOP ROLLER	SPROCKET	IDLER	TRACK
				
				REF 143TA9801 (rubber) (180 x 72 x 37)
KOMATSU PC03-2A				
REF 143TA8691		REF 143TA9133 (number of teeth = 12) (number of holes = 9)	REF 143TA9402 (front, with bracket assembly) (Ø = 246,00 mm)	REF 164TA2037 (rubber) (180 x 72 x 37) (colored) REF 143TA9801 (rubber) (180 x 72 x 37)
KOMATSU PC05-1				
REF 143TA8692		REF 143TA9135	REF 143TA9403 (front, with bracket assembly)	REF 164TA2049 (steel) (width = 230,00 mm) (with rubber) REF 164TA2050 (steel)
KOMATSU PC05-5				
<i>S/N: 02501 - 03100</i>				
REF 143TA8693 (for rubber tracks)		REF 143TA9136 (for rubber tracks) (number of teeth = 21) (number of holes = 12)	REF 143TA9404 (front, with bracket assembly) (for rubber tracks)	REF 163TA9519 (rubber) (230 x 72 x 42)
REF 143TA8695 (for steel tracks) (Ø flange = 100,00 mm) (Ø body = 80,00 mm)		REF 143TA9137 (for steel tracks)	REF 143TA9405 (front, with bracket assembly) (for steel tracks)	REF 143TA9804 (steel)
<i>S/N: 03101 - and up</i>				
REF 143TA8694 (for rubber tracks)		REF 143TA9136 (for rubber tracks) (number of teeth = 21) (number of holes = 12)	REF 143TA9404 (front, with bracket assembly) (for rubber tracks)	REF 163TA9519 (rubber) (230 x 72 x 42)
REF 143TA8696 (for steel tracks) (Ø flange = 100,00 mm) (Ø body = 80,00 mm)		REF 143TA9137 (for steel tracks)	REF 143TA9405 (front, with bracket assembly) (for steel tracks)	REF 143TA9804 (steel)
KOMATSU PC05-6				
REF 143TA8696 (Ø flange = 100,00 mm) (Ø body = 80,00 mm)		REF 143TA9138 (number of teeth = 19) (number of holes = 9)	REF 143TA9405 (front, with bracket assembly)	REF 143TA9805 (rubber) (230 x 96 x 31) REF 163TA9525 (steel) (width = 230,00 mm)
KOMATSU PC05-7				
<i>S/N: 08001 - 10616</i>				
REF 143TA8697 (Ø flange = 100,00 mm) (Ø body = 80,00 mm)		REF 143TA9138 (number of teeth = 19) (number of holes = 9)	REF 143TA9406 (front, with bracket assembly)	REF 143TA9805 (rubber) (230 x 96 x 31)
<i>S/N: 08001 - and up</i>				
				REF 163TA9525 (steel) (width = 230,00 mm)
<i>S/N: 10617 - and up</i>				
REF 143TA8698 (Ø flange = 100,00 mm) (Ø body = 80,00 mm)		REF 143TA9139 (number of teeth = 19) (number of holes = 9)	REF 143TA9407 (front, with bracket assembly)	REF 143TA9806 (rubber) (230 x 96 x 31)
<i>S/N: F20001 - and up</i>				
REF 143TA8699 (Ø flange = 100,00 mm) (Ø body = 80,00 mm)		REF 163TA8923 (number of teeth = 19) (number of holes = 9)		REF 143TA9822 (steel) (width = 230,00 mm) (number of links = 32)





used for KOMATSU				
TRACK ROLLER	TOP ROLLER	SPROCKET	IDLER	TRACK
<i>S/N: F20001 - F20393</i>				
				
			REF 143TA9408 (front, with bracket assembly)	REF 143TA9807 (rubber) (230 x 96 x 31)
<i>S/N: F20394 - and up</i>				
			REF 143TA9409 (front, with bracket assembly)	REF 143TA9808 (rubber) (230 x 96 x 31)
KOMATSU PC07-1				
REF 143TA8696 (∅ flange = 100,00 mm) (∅ body = 80,00 mm)		REF 143TA9138 (number of teeth = 19) (number of holes = 9)	REF 143TA9405 (front, with bracket assembly)	REF 143TA9805 (rubber) (230 x 96 x 31) REF 163TA9525 (steel) (width = 230,00 mm)
KOMATSU PC07-2				
<i>S/N: 03001 - 04558</i>				
REF 143TA8697 (∅ flange = 100,00 mm) (∅ body = 80,00 mm)			REF 143TA9406 (front, with bracket assembly)	
<i>S/N: 03001 - 05460</i>				
		REF 143TA9138 (number of teeth = 19) (number of holes = 9)		REF 143TA9805 (rubber) (230 x 96 x 31)
<i>S/N: 03001 - and up</i>				
				REF 163TA9525 (steel) (width = 230,00 mm)
<i>S/N: 04559 - and up</i>				
REF 143TA8698 (∅ flange = 100,00 mm) (∅ body = 80,00 mm)			REF 143TA9407 (front, with bracket assembly)	
<i>S/N: 05461 - and up</i>				
		REF 143TA9139 (number of teeth = 19) (number of holes = 9)		REF 143TA9806 (rubber) (230 x 96 x 31)
<i>S/N: F10001 - and up</i>				
REF 143TA8699 (∅ flange = 100,00 mm) (∅ body = 80,00 mm)		REF 163TA8923 (number of teeth = 19) (number of holes = 9)		REF 143TA9822 (steel) (width = 230,00 mm) (number of links = 32)
<i>S/N: F10001 - F10465</i>				
			REF 143TA9408 (front, with bracket assembly)	REF 143TA9807 (rubber) (230 x 96 x 31)
<i>S/N: F10466 - and up</i>				
			REF 143TA9409 (front, with bracket assembly)	REF 143TA9808 (rubber) (230 x 96 x 31)
KOMATSU PC08UU-1				
REF 143TA8700		REF 143TA9141	REF 143TA9410 (front, with bracket assembly)	REF 143TA9809 (rubber) (200 x 72 x 40)
KOMATSU PC08UU-1A				
REF 143TA8700		REF 143TA9141	REF 143TA9410 (front, with bracket assembly)	REF 143TA9809 (rubber) (200 x 72 x 40)
KOMATSU PC09-1				
<i>S/N: 10001 - 10108</i>				
REF 143TA8701		REF 143TA9134 (number of teeth = 12) (number of holes = 9)	REF 143TA9411 (front, with bracket assembly) (∅ = 246,00 mm)	REF 143TA9810 (rubber) (180 x 72 x 37)







used for KOMATSU

used for KOMATSU				
TRACK ROLLER	TOP ROLLER	SPROCKET	IDLER	TRACK
				
<i>S/N: 10109 - and up</i>				
REF 143TA8702		REF 143TA9134 (number of teeth = 12) (number of holes = 9)	REF 143TA9411 (front, with bracket assembly) (Ø = 246,00 mm)	REF 143TA9810 (rubber) (180 x 72 x 37)
KOMATSU PC09-1A				
<i>S/N: 10001 - 10108</i>				
REF 143TA8701		REF 143TA9134 (number of teeth = 12) (number of holes = 9)	REF 143TA9411 (front, with bracket assembly) (Ø = 246,00 mm)	REF 143TA9810 (rubber) (180 x 72 x 37)
<i>S/N: 10109 - and up</i>				
REF 143TA8702		REF 143TA9134 (number of teeth = 12) (number of holes = 9)	REF 143TA9411 (front, with bracket assembly) (Ø = 246,00 mm)	REF 143TA9810 (rubber) (180 x 72 x 37)
KOMATSU PC09-1B				
<i>S/N: 10001 - 10108</i>				
REF 143TA8701		REF 143TA9134 (number of teeth = 12) (number of holes = 9)	REF 143TA9411 (front, with bracket assembly) (Ø = 246,00 mm)	REF 143TA9810 (rubber) (180 x 72 x 37)
<i>S/N: 10109 - and up</i>				
REF 143TA8702		REF 143TA9134 (number of teeth = 12) (number of holes = 9)	REF 143TA9411 (front, with bracket assembly) (Ø = 246,00 mm)	REF 143TA9810 (rubber) (180 x 72 x 37)
KOMATSU PC09FR-1				
REF 164TA2554		REF 164TA2079	REF 143TA9412 (front, with bracket assembly)	REF 164TA2555 (rubber) (200 x 73 x 43)
KOMATSU PC10-1				
REF 143TA8704 (Ø flange = 115,00 mm) (Ø body = 85,00 mm)		REF 143TA9143	REF 143TA9413 (front, with bracket assembly)	REF 143TA9812 (steel) (width = 250,00 mm) (number of links = 38)
KOMATSU PC10-2				
REF 143TA8704 (Ø flange = 115,00 mm) (Ø body = 85,00 mm)		REF 143TA9143	REF 143TA9413 (front, with bracket assembly)	REF 143TA9812 (steel) (width = 250,00 mm) (number of links = 38)
KOMATSU PC10-3				
REF 143TA8704 (Ø flange = 115,00 mm) (Ø body = 85,00 mm)		REF 143TA9144	REF 143TA9413 (front, with bracket assembly)	REF 143TA9812 (steel) (width = 250,00 mm) (number of links = 38) REF 163TA9526 (steel) (width = 300,00 mm)
KOMATSU PC10-5				
<i>S/N: 07001 - 08000</i>				
REF 143TA8704 (for steel tracks) (Ø flange = 115,00 mm) (Ø body = 85,00 mm)		REF 143TA9145 (for rubber tracks) REF 143TA9144 (for steel tracks)	REF 143TA9414 (front, with bracket assembly) (for rubber tracks) (Ø = 338,00 mm) REF 143TA9415 (front, with bracket assembly) (for steel tracks)	REF 143TA9813 (rubber) (width = 260,00 mm) REF 143TA9812 (steel) (width = 250,00 mm) (number of links = 38) REF 163TA9526 (steel) (width = 300,00 mm)







used for KOMATSU				
TRACK ROLLER	TOP ROLLER	SPROCKET	IDLER	TRACK
				
<i>S/N: 08001 - and up</i>				
<p>REF 143TA8706 (for steel tracks) (Ø flange = 115,00 mm) (Ø body = 85,00 mm)</p> <p>REF 143TA8705 (for rubber tracks)</p>		<p>REF 143TA9145 (for rubber tracks)</p> <p>REF 143TA9144 (for steel tracks)</p>	<p>REF 143TA9414 (front, with bracket assembly) (for rubber tracks) (Ø = 338,00 mm)</p> <p>REF 143TA9415 (front, with bracket assembly) (for steel tracks)</p>	<p>REF 143TA9813 (rubber) (width = 260,00 mm)</p> <p>REF 143TA9812 (steel) (width = 250,00 mm) (number of links = 38)</p> <p>REF 163TA9526 (steel) (width = 300,00 mm)</p>
KOMATSU PC10-6				
<i>S/N: 20001 - 22464</i>				
<p>REF 143TA8707 (Ø flange = 115,00 mm) (Ø body = 85,00 mm)</p>		<p>REF 143TA9146 (number of teeth = 23) (number of holes = 9)</p>	<p>REF 143TA9416 (front, with bracket assembly) (Ø = 338,00 mm)</p>	<p>REF 143TA9814 (rubber) (260 x 109 x 37)</p> <p>REF 143TA9826 (steel) (width = 250,00 mm) (number of links = 38)</p> <p>REF 163TA9527 (steel) (width = 300,00 mm)</p>
<i>S/N: 22465 - and up</i>				
<p>REF 143TA8708 (Ø flange = 108,00 mm) (Ø body = 85,00 mm)</p>		<p>REF 143TA9146 (number of teeth = 23) (number of holes = 9)</p>	<p>REF 143TA9417 (front, with bracket assembly) (Ø = 338,00 mm)</p>	<p>REF 143TA9814 (rubber) (260 x 109 x 37)</p> <p>REF 143TA9826 (steel) (width = 250,00 mm) (number of links = 38)</p> <p>REF 163TA9527 (steel) (width = 300,00 mm)</p>
KOMATSU PC10-7				
<i>S/N: 25001 - 27776</i>				
<p>REF 143TA8707 (for steel tracks) (Ø flange = 115,00 mm) (Ø body = 85,00 mm)</p> <p>REF 143TA8715 (for rubber tracks) (Ø flange = 145,00 mm) (Ø body = 85,00 mm)</p>	<p>REF 143TA8941 (assembly) (for rubber tracks) (Ø flange = 130,00 mm) (Ø body = 72,00 mm)</p> <p>REF 143TA8942 (assembly) (for steel tracks) (Ø body = 70,00 mm)</p> <p>REF 143TA8944 (assembly) (for steel tracks) (Ø body = 70,00 mm)</p>	<p>REF 143TA9146 (number of teeth = 23) (number of holes = 9)</p>	<p>REF 143TA9419 (front, with bracket assembly) (for steel tracks) (Ø = 338,00 mm)</p> <p>REF 143TA9418 (front, with bracket assembly) (for rubber tracks) (Ø = 338,00 mm)</p>	<p>REF 144TA1036 (rubber) (250 x 52,5 x 76)</p> <p>REF 144TA1037 (rubber) (250 x 52,5 x 76) (with rail)</p> <p>REF 143TA9826 (steel) (width = 250,00 mm) (number of links = 38)</p> <p>REF 163TA9527 (steel) (width = 300,00 mm)</p>
<i>S/N: 27777 - and up</i>				
<p>REF 143TA8708 (for steel tracks) (Ø flange = 108,00 mm) (Ø body = 85,00 mm)</p> <p>REF 143TA8715 (for rubber tracks) (Ø flange = 145,00 mm) (Ø body = 85,00 mm)</p>	<p>REF 143TA8941 (assembly) (for rubber tracks) (Ø flange = 130,00 mm) (Ø body = 72,00 mm)</p> <p>REF 143TA8942 (assembly) (for steel tracks) (Ø body = 70,00 mm)</p>	<p>REF 143TA9147 (number of teeth = 23) (number of holes = 9)</p>	<p>REF 143TA9420 (front, with bracket assembly) (for steel tracks) (Ø = 338,00 mm)</p> <p>REF 143TA9418 (front, with bracket assembly) (for rubber tracks) (Ø = 338,00 mm)</p>	<p>REF 143TA9815 (rubber) (260 x 109 x 37)</p> <p>REF 144TA1037 (rubber) (250 x 52,5 x 76) (with rail)</p>







used for KOMATSU				
TRACK ROLLER	TOP ROLLER	SPROCKET	IDLER	TRACK
				
	REF 143TA8944 (assembly) (for steel tracks) (Ø body = 70,00 mm)			REF 143TA9826 (steel) (width = 250,00 mm) (number of links = 38) REF 163TA9527 (steel) (width = 300,00 mm)
<i>S/N: F25001 - and up</i>				
REF 143TA8715 (for rubber tracks) (Ø flange = 145,00 mm) (Ø body = 85,00 mm)	REF 143TA8941 (assembly) (for rubber tracks) (Ø flange = 130,00 mm) (Ø body = 72,00 mm) REF 143TA8942 (assembly) (for steel tracks) (Ø body = 70,00 mm) REF 143TA8944 (assembly) (for steel tracks) (Ø body = 70,00 mm)	REF 143TA9148 (number of teeth = 23) (number of holes = 9)	REF 143TA9418 (front, with bracket assembly) (for rubber tracks) (Ø = 338,00 mm)	REF 143TA9817 (steel) (width = 300,00 mm) (number of links = 38) REF 144TA1037 (rubber) (250 x 52,5 x 76) (with rail) REF 143TA9826 (steel) (width = 250,00 mm) (number of links = 38) REF 163TA9527 (steel) (width = 300,00 mm)
<i>S/N: F25001 - F25131</i>				
REF 143TA8709 (Ø flange = 145,00 mm) (Ø body = 85,00 mm)	REF 143TA8943 (assembly) (for rubber tracks) (Ø flange = 130,00 mm) (Ø body = 72,00 mm) REF 143TA8941 (assembly) (for rubber tracks) (Ø flange = 130,00 mm) (Ø body = 72,00 mm) REF 143TA8942 (assembly) (for steel tracks) (Ø body = 70,00 mm) REF 143TA8944 (assembly) (for steel tracks) (Ø body = 70,00 mm)		REF 143TA9421 (front, with bracket assembly) (for rubber tracks) REF 143TA9422 (front, with bracket assembly) (for steel tracks) REF 143TA9418 (front, with bracket assembly) (for rubber tracks) (Ø = 338,00 mm)	REF 143TA9816 (rubber) (250 x 52,5 x 76) REF 144TA1037 (rubber) (250 x 52,5 x 76) (with rail) REF 143TA9826 (steel) (width = 250,00 mm) (number of links = 38) REF 163TA9527 (steel) (width = 300,00 mm)
REF 143TA8710 (Ø flange = 115,00 mm) (Ø body = 85,00 mm)				
REF 143TA8715 (for rubber tracks) (Ø flange = 145,00 mm) (Ø body = 85,00 mm)				
<i>S/N: F25132 - and up</i>				
REF 164TA2105	REF 143TA8941 (assembly) (for rubber tracks) (Ø flange = 130,00 mm) (Ø body = 72,00 mm) REF 143TA8942 (assembly) (for steel tracks) (Ø body = 70,00 mm) REF 143TA8944 (assembly) (for steel tracks) (Ø body = 70,00 mm)		REF 143TA9423 (front, with bracket assembly) (for rubber and steel tracks) REF 143TA9418 (front, with bracket assembly) (for rubber tracks) (Ø = 338,00 mm)	REF 143TA9818 (rubber) (250 x 52,5 x 76) REF 144TA1037 (rubber) (250 x 52,5 x 76) (with rail) REF 143TA9826 (steel) (width = 250,00 mm) (number of links = 38) REF 163TA9527 (steel) (width = 300,00 mm)
REF 143TA8715 (for rubber tracks) (Ø flange = 145,00 mm) (Ø body = 85,00 mm)				
KOMATSU PC10MR-1				
REF 143TA8700		REF 143TA9133 (number of teeth = 12) (number of holes = 9)	REF 143TA9411 (front, with bracket assembly) (Ø = 246,00 mm)	REF 143TA9819 (rubber) (180 x 72 x 41)



used for KOMATSU				
TRACK ROLLER	TOP ROLLER	SPROCKET	IDLER	TRACK
				
KOMATSU PC10MR-1A				
REF 143TA8700		REF 143TA9133 (number of teeth = 12) (number of holes = 9)	REF 143TA9411 (front, with bracket assembly) (\emptyset = 246,00 mm)	REF 143TA9819 (rubber) (180 x 72 x 41)
KOMATSU PC10MR-1B				
REF 143TA8700		REF 143TA9133 (number of teeth = 12) (number of holes = 9)	REF 143TA9411 (front, with bracket assembly) (\emptyset = 246,00 mm)	REF 143TA9819 (rubber) (180 x 72 x 41)
KOMATSU PC10N-7				
REF 143TA8711 (\emptyset flange = 108,00 mm) (\emptyset body = 85,00 mm)		REF 143TA9147 (number of teeth = 23) (number of holes = 9)	REF 143TA9424 (front, with bracket assembly)	REF 143TA9815 (rubber) (260 x 109 x 37) REF 143TA9826 (steel) (width = 250,00 mm) (number of links = 38) REF 163TA9527 (steel) (width = 300,00 mm)
KOMATSU PC10UU-3				
REF 143TA8690		REF 143TA9133 (number of teeth = 12) (number of holes = 9)	REF 143TA9411 (front, with bracket assembly) (\emptyset = 246,00 mm)	REF 143TA9819 (rubber) (180 x 72 x 41)
KOMATSU PC12R-8				
<i>S/N: 10001 - and up</i>				
REF 143TA8712 (for rubber tracks) (\emptyset flange = 96,00 mm) (\emptyset body = 80,00 mm) REF 143TA8712 (for steel tracks) (\emptyset flange = 96,00 mm) (\emptyset body = 80,00 mm)		REF 143TA9149	REF 143TA9425 (front, with bracket assembly) (for rubber tracks) (\emptyset = 226,00 mm) REF 143TA9426 (front, with bracket assembly) (for steel tracks) (\emptyset = 266,00 mm)	REF 143TA9820 (rubber) (250 x 52,5 x 76) REF 143TA9821 (steel)
<i>S/N: F30001 - and up</i>				
		REF 163TA8923 (number of teeth = 19) (number of holes = 9)	REF 143TA9427 (front, with bracket assembly) (for rubber tracks) (\emptyset = 266,00 mm) REF 143TA9428 (front, with bracket assembly) (for steel tracks) (\emptyset = 266,00 mm)	REF 143TA9822 (steel) (width = 230,00 mm) (number of links = 32)
<i>S/N: F30001 - F31892</i>				
				REF 143TA9808 (rubber) (230 x 96 x 31)
<i>S/N: F30001 - F32054</i>				
REF 143TA8713 (for rubber tracks) (\emptyset flange = 96,00 mm) (\emptyset body = 80,00 mm) REF 143TA8713 (for steel tracks) (\emptyset flange = 96,00 mm) (\emptyset body = 80,00 mm)				
<i>S/N: F31893 - and up</i>				
				REF 143TA9823 (rubber) (230 x 96 x 31)



used for KOMATSU				
TRACK ROLLER	TOP ROLLER	SPROCKET	IDLER	TRACK
				
<i>S/N: F32055 - and up</i>				
REF 143TA8714 (for steel tracks) (Ø flange = 96,00 mm) (Ø body = 80,00 mm)				
KOMATSU PC12UU-1				
REF 143TA8707 (Ø flange = 115,00 mm) (Ø body = 85,00 mm)		REF 143TA9150	REF 143TA9416 (front, with bracket assembly) (Ø = 338,00 mm)	REF 143TA9824 (rubber) (260 x 109 x 37) REF 143TA9826 (steel) (width = 250,00 mm) (number of links = 38)
KOMATSU PC12UU-2				
<i>S/N: 03001 - 04600</i>				
REF 143TA8707 (for steel tracks) (Ø flange = 115,00 mm) (Ø body = 85,00 mm)		REF 143TA9146 (number of teeth = 23) (number of holes = 9)	REF 143TA9429 (front, with bracket assembly) (for rubber tracks)	REF 143TA9825 (rubber) (250 x 52,5 x 76)
REF 143TA8715 (for rubber tracks) (Ø flange = 145,00 mm) (Ø body = 85,00 mm)			REF 143TA9430 (front, with bracket assembly) (for steel tracks)	REF 143TA9826 (steel) (width = 250,00 mm) (number of links = 38)
<i>S/N: 04601 - and up</i>				
REF 143TA8711 (Ø flange = 108,00 mm) (Ø body = 85,00 mm)		REF 143TA9147 (number of teeth = 23) (number of holes = 9)	REF 143TA9424 (front, with bracket assembly) (for rubber tracks)	REF 143TA9815 (rubber) (260 x 109 x 37)
			REF 143TA9430 (front, with bracket assembly) (for steel tracks)	REF 143TA9826 (steel) (width = 250,00 mm) (number of links = 38)
KOMATSU PC14R-2				
REF 143TA8716 (for rubber and steel tracks) (Ø flange = 96,00 mm) (Ø body = 80,00 mm)		REF 143TA9151 (number of teeth = 19) (number of holes = 9)	REF 143TA9431 (front, with bracket assembly) (for rubber tracks)	REF 143TA9827 (rubber) (230 x 96 x 31)
			REF 143TA9432 (front, with bracket assembly) (for steel tracks) (Ø = 266,00 mm)	REF 143TA9830 (rubber) (230 x 96 x 35) (for variable gauge) REF 143TA9828 (steel) (width = 230,00 mm) (number of links = 32)
				REF 164TA2053 (steel) (for variable gauge)
KOMATSU PC14R-3				
REF 143TA8716 (for rubber and steel tracks) (Ø flange = 96,00 mm) (Ø body = 80,00 mm)		REF 143TA9151 (number of teeth = 19) (number of holes = 9)	REF 143TA9431 (front, with bracket assembly) (for rubber tracks)	REF 143TA9829 (rubber) (230 x 96 x 31)
			REF 143TA9432 (front, with bracket assembly) (for steel tracks) (Ø = 266,00 mm)	REF 143TA9828 (steel) (width = 230,00 mm) (number of links = 32)
KOMATSU PC14R-3HS				
REF 143TA8716 (for rubber and steel tracks) (Ø flange = 96,00 mm) (Ø body = 80,00 mm)		REF 143TA9151 (number of teeth = 19) (number of holes = 9)	REF 143TA9431 (front, with bracket assembly) (for rubber tracks)	REF 143TA9830 (rubber) (230 x 96 x 35)
			REF 143TA9432 (front, with bracket assembly) (for steel tracks) (Ø = 266,00 mm)	REF 143TA9831 (steel)







used for KOMATSU				
TRACK ROLLER	TOP ROLLER	SPROCKET	IDLER	TRACK
				
KOMATSU PC15-1				
<p>REF 143TA8717 (for rubber tracks)</p> <p>REF 143TA8706 (for steel tracks) (∅ flange = 115,00 mm) (∅ body = 85,00 mm)</p>		<p>REF 143TA9145 (for rubber tracks)</p> <p>REF 143TA9144 (for steel tracks)</p>	<p>REF 143TA9414 (front, with bracket assembly) (for rubber tracks) (∅ = 338,00 mm)</p> <p>REF 143TA9415 (front, with bracket assembly) (for steel tracks)</p>	<p>REF 143TA9832 (rubber) (300 x 109 x 39) (with rail)</p> <p>REF 163TA9522 (steel) (width = 300,00 mm) (double)</p> <p>REF 163TA9523 (steel) (width = 350,00 mm) (double)</p> <p>REF 164TA2054 (steel) (width = 350,00 mm) (single)</p>
KOMATSU PC15-2				
<i>S/N: 02001 - 03337</i>				
<p>REF 143TA8707 (∅ flange = 115,00 mm) (∅ body = 85,00 mm)</p>		<p>REF 143TA9146 (number of teeth = 23) (number of holes = 9)</p>	<p>REF 143TA9416 (front, with bracket assembly) (∅ = 338,00 mm)</p>	<p>REF 143TA9833 (rubber) (260 x 109 x 39)</p> <p>REF 163TA9524 (steel) (width = 300,00 mm)</p>
<i>S/N: 03338 - and up</i>				
<p>REF 143TA8708 (∅ flange = 108,00 mm) (∅ body = 85,00 mm)</p>		<p>REF 143TA9146 (number of teeth = 23) (number of holes = 9)</p>	<p>REF 143TA9417 (front, with bracket assembly) (∅ = 338,00 mm)</p>	<p>REF 143TA9833 (rubber) (260 x 109 x 39)</p> <p>REF 163TA9524 (steel) (width = 300,00 mm)</p>
KOMATSU PC15-2A				
<i>S/N: 02001 - 03337</i>				
<p>REF 143TA8707 (∅ flange = 115,00 mm) (∅ body = 85,00 mm)</p>		<p>REF 143TA9146 (number of teeth = 23) (number of holes = 9)</p>	<p>REF 143TA9416 (front, with bracket assembly) (∅ = 338,00 mm)</p>	<p>REF 143TA9833 (rubber) (260 x 109 x 39)</p> <p>REF 163TA9524 (steel) (width = 300,00 mm)</p>
<i>S/N: 03338 - and up</i>				
<p>REF 143TA8708 (∅ flange = 108,00 mm) (∅ body = 85,00 mm)</p>		<p>REF 143TA9146 (number of teeth = 23) (number of holes = 9)</p>	<p>REF 143TA9417 (front, with bracket assembly) (∅ = 338,00 mm)</p>	<p>REF 143TA9833 (rubber) (260 x 109 x 39)</p> <p>REF 163TA9524 (steel) (width = 300,00 mm)</p>
KOMATSU PC15-3				
<i>S/N: 05001 - 06221</i>				
<p>REF 143TA8707 (for steel tracks) (∅ flange = 115,00 mm) (∅ body = 85,00 mm)</p> <p>REF 143TA8715 (for rubber tracks) (∅ flange = 145,00 mm) (∅ body = 85,00 mm)</p>	<p>REF 143TA8941 (assembly) (for rubber tracks) (∅ flange = 130,00 mm) (∅ body = 72,00 mm)</p> <p>REF 143TA8942 (assembly) (for steel tracks) (∅ body = 70,00 mm)</p>	<p>REF 143TA9146 (number of teeth = 23) (number of holes = 9)</p>	<p>REF 143TA9418 (front, with bracket assembly) (for rubber tracks) (∅ = 338,00 mm)</p> <p>REF 143TA9419 (front, with bracket assembly) (for steel tracks) (∅ = 338,00 mm)</p>	<p>REF 143TA9834 (rubber) (300 x 109 x 39) (with rail)</p> <p>REF 163TA9524 (steel) (width = 300,00 mm)</p> <p>REF 163TA9528 (steel) (width = 350,00 mm)</p>



used for KOMATSU				
TRACK ROLLER	TOP ROLLER	SPROCKET	IDLER	TRACK
				
<i>S/N: 06222 - and up</i>				
<p>REF 143TA8708 (for steel tracks) (Ø flange = 108,00 mm) (Ø body = 85,00 mm)</p> <p>REF 143TA8715 (for rubber tracks) (Ø flange = 145,00 mm) (Ø body = 85,00 mm)</p>	<p>REF 143TA8941 (assembly) (for rubber tracks) (Ø flange = 130,00 mm) (Ø body = 72,00 mm)</p> <p>REF 143TA8942 (assembly) (for steel tracks) (Ø body = 70,00 mm)</p>	<p>REF 143TA9147 (number of teeth = 23) (number of holes = 9)</p>	<p>REF 143TA9418 (front, with bracket assembly) (for rubber tracks) (Ø = 338,00 mm)</p> <p>REF 143TA9419 (front, with bracket assembly) (for steel tracks) (Ø = 338,00 mm)</p>	<p>REF 143TA9835 (rubber) (300 x 52,5 x 80)</p> <p>REF 163TA9524 (steel) (width = 300,00 mm)</p> <p>REF 163TA9528 (steel) (width = 350,00 mm)</p>
KOMATSU PC15FR-1				
<p>REF 144TA4480 (Ø flange = 129,50 mm) (Ø body = 68,00 mm)</p>		<p>REF 164TA2080 (number of teeth = 14) (number of holes = 9)</p>	<p>REF 143TA9433 (front, with bracket assembly) (Ø = 282,00 mm)</p>	<p>REF 143TA9836 (rubber) (230 x 72 x 47)</p>
KOMATSU PC15MR-1				
<p>REF 143TA8719 (for rubber and steel tracks) (Ø flange = 96,00 mm) (Ø body = 80,00 mm)</p>		<p>REF 143TA9153 (number of teeth = 19) (number of holes = 9)</p>	<p>REF 143TA9434 (front, with bracket assembly) (for rubber tracks) (Ø = 266,00 mm)</p> <p>REF 143TA9435 (front, with bracket assembly) (for steel tracks) (Ø = 266,00 mm)</p>	<p>REF 143TA9837 (rubber) (230 x 96 x 35)</p> <p>REF 143TA9838 (steel)</p>
KOMATSU PC15MRX-1				
<i>S/N: 10001 - 10048</i>				
<p>REF 143TA8719 (for rubber and steel tracks) (Ø flange = 96,00 mm) (Ø body = 80,00 mm)</p>		<p>REF 143TA9153 (number of teeth = 19) (number of holes = 9)</p>	<p>REF 143TA9434 (front, with bracket assembly) (for rubber tracks) (Ø = 266,00 mm)</p>	<p>REF 143TA9838 (steel)</p>
<i>S/N: 10001 - 10459</i>				
<p>REF 143TA8719 (for rubber and steel tracks) (Ø flange = 96,00 mm) (Ø body = 80,00 mm)</p>			<p>REF 143TA9434 (front, with bracket assembly) (for rubber tracks) (Ø = 266,00 mm)</p>	<p>REF 143TA9837 (rubber) (230 x 96 x 35)</p> <p>REF 143TA9838 (steel)</p>
<i>S/N: 10001 - 12558</i>				
<p>REF 143TA8719 (for rubber and steel tracks) (Ø flange = 96,00 mm) (Ø body = 80,00 mm)</p>			<p>REF 143TA9426 (front, with bracket assembly) (for steel tracks) (Ø = 266,00 mm)</p> <p>REF 143TA9434 (front, with bracket assembly) (for rubber tracks) (Ø = 266,00 mm)</p>	<p>REF 143TA9838 (steel)</p>
<i>S/N: 10049 - and up</i>				
<p>REF 143TA8719 (for rubber and steel tracks) (Ø flange = 96,00 mm) (Ø body = 80,00 mm)</p>		<p>REF 143TA9154 (number of teeth = 19) (number of holes = 9)</p>	<p>REF 143TA9434 (front, with bracket assembly) (for rubber tracks) (Ø = 266,00 mm)</p>	<p>REF 143TA9838 (steel)</p>



used for KOMATSU				
TRACK ROLLER	TOP ROLLER	SPROCKET	IDLER	TRACK
				
<i>S/N: 10460 - and up</i>				
REF 143TA8719 (for rubber and steel tracks) (Ø flange = 96,00 mm) (Ø body = 80,00 mm)			REF 143TA9434 (front, with bracket assembly) (for rubber tracks) (Ø = 266,00 mm)	REF 143TA9839 (rubber) (230 x 96 x 35) REF 143TA9838 (steel)
<i>S/N: 12559 - and up</i>				
REF 143TA8719 (for rubber and steel tracks) (Ø flange = 96,00 mm) (Ø body = 80,00 mm)			REF 143TA9436 (front, with bracket assembly) (for steel tracks) (Ø = 266,00 mm) REF 143TA9434 (front, with bracket assembly) (for rubber tracks) (Ø = 266,00 mm)	REF 143TA9838 (steel)
KOMATSU PC15R-8				
<i>S/N: 10001 - and up</i>				
REF 143TA8712 (for rubber and steel tracks) (Ø flange = 96,00 mm) (Ø body = 80,00 mm)		REF 143TA9149	REF 143TA9425 (front, with bracket assembly) (for rubber tracks) (Ø = 226,00 mm) REF 143TA9426 (front, with bracket assembly) (for steel tracks) (Ø = 266,00 mm)	REF 143TA9806 (rubber) (230 x 96 x 31) REF 143TA9821 (steel)
<i>S/N: F20001 - and up</i>				
REF 143TA8713 (for rubber and steel tracks) (Ø flange = 96,00 mm) (Ø body = 80,00 mm)		REF 163TA8923 (number of teeth = 19) (number of holes = 9)	REF 143TA9427 (front, with bracket assembly) (for rubber tracks) (Ø = 266,00 mm) REF 143TA9428 (front, with bracket assembly) (for steel tracks) (Ø = 266,00 mm)	REF 143TA9823 (rubber) (230 x 96 x 31) REF 143TA9822 (steel) (width = 230,00 mm) (number of links = 32)
<i>S/N: F22426 - and up</i>				
				REF 143TA9822 (steel) (width = 230,00 mm) (number of links = 32)
<i>S/N: F22762 - and up</i>				
				REF 143TA9808 (rubber) (230 x 96 x 31)
<i>S/N: F22972 - and up</i>				
REF 143TA8720 (for rubber and steel tracks) (Ø flange = 96,00 mm) (Ø body = 80,00 mm)				
KOMATSU PC15R-8 Deluxe				
<i>S/N: F22426 - F22761</i>				
REF 143TA8713 (for rubber and steel tracks) (Ø flange = 96,00 mm) (Ø body = 80,00 mm)		REF 163TA8923 (number of teeth = 19) (number of holes = 9)	REF 143TA9427 (front, with bracket assembly) (for rubber tracks) (Ø = 266,00 mm)	REF 143TA9823 (rubber) (230 x 96 x 31)







used for KOMATSU				
TRACK ROLLER	TOP ROLLER	SPROCKET	IDLER	TRACK
				
			REF 143TA9428 (front, with bracket assembly) (for steel tracks) (Ø = 266,00 mm)	REF 143TA9822 (steel) (width = 230,00 mm) (number of links = 32)
<i>S/N: F22762 - and up</i>				
REF 143TA8713 (for rubber and steel tracks) (Ø flange = 96,00 mm) (Ø body = 80,00 mm)		REF 163TA8923 (number of teeth = 19) (number of holes = 9)	REF 143TA9427 (front, with bracket assembly) (for rubber tracks) (Ø = 266,00 mm) REF 143TA9428 (front, with bracket assembly) (for steel tracks) (Ø = 266,00 mm)	REF 143TA9808 (rubber) (230 x 96 x 31) REF 143TA9822 (steel) (width = 230,00 mm) (number of links = 32)
KOMATSU PC15T-2				
<i>S/N: 02001 - 03337</i>				
REF 143TA8707 (Ø flange = 115,00 mm) (Ø body = 85,00 mm)		REF 143TA9146 (number of teeth = 23) (number of holes = 9)	REF 143TA9416 (front, with bracket assembly) (Ø = 338,00 mm)	REF 143TA9840 (rubber) (260 x 109 x 39)
<i>S/N: 03338 - and up</i>				
REF 143TA8708 (Ø flange = 108,00 mm) (Ø body = 85,00 mm)		REF 143TA9146 (number of teeth = 23) (number of holes = 9)	REF 143TA9417 (front, with bracket assembly) (Ø = 338,00 mm)	REF 143TA9840 (rubber) (260 x 109 x 39)
KOMATSU PC16R-2				
REF 143TA8716 (for rubber and steel tracks) (Ø flange = 96,00 mm) (Ø body = 80,00 mm)		REF 143TA9151 (number of teeth = 19) (number of holes = 9)	REF 143TA9431 (front, with bracket assembly) (for rubber tracks) REF 143TA9432 (front, with bracket assembly) (for steel tracks) (Ø = 266,00 mm)	REF 143TA9827 (rubber) (230 x 96 x 31) REF 143TA9830 (rubber) (230 x 96 x 35) (for variable gauge) REF 143TA9828 (steel) (width = 230,00 mm) (number of links = 32) REF 164TA2053 (steel) (for variable gauge)
KOMATSU PC16R-3				
REF 143TA8716 (for rubber and steel tracks) (Ø flange = 96,00 mm) (Ø body = 80,00 mm)		REF 143TA9151 (number of teeth = 19) (number of holes = 9)	REF 143TA9431 (front, with bracket assembly) (for rubber tracks) REF 143TA9432 (front, with bracket assembly) (for steel tracks) (Ø = 266,00 mm)	REF 143TA9829 (rubber) (230 x 96 x 31) REF 143TA9828 (steel) (width = 230,00 mm) (number of links = 32)
KOMATSU PC16R-3 HS				
REF 143TA8716 (for rubber and steel tracks) (Ø flange = 96,00 mm) (Ø body = 80,00 mm)		REF 143TA9151 (number of teeth = 19) (number of holes = 9)	REF 143TA9431 (front, with bracket assembly) (for rubber tracks) REF 143TA9432 (front, with bracket assembly) (for steel tracks) (Ø = 266,00 mm)	REF 143TA9830 (rubber) (230 x 96 x 35) REF 143TA9831 (steel)





TRACKS & UNDERCARRIAGE PARTS







used for KOMATSU

used for KOMATSU				
TRACK ROLLER	TOP ROLLER	SPROCKET	IDLER	TRACK
				
KOMATSU PC18MR-2				
<i>S/N: 15001 - 17913</i>				
REF 143TA8721 (for rubber and steel tracks) (Ø flange = 96,00 mm) (Ø body = 80,00 mm)		REF 143TA9154 (number of teeth = 19) (number of holes = 9)	REF 143TA9434 (front, with bracket assembly) (for rubber tracks) (Ø = 266,00 mm) REF 143TA9435 (front, with bracket assembly) (for steel tracks) (Ø = 266,00 mm)	REF 143TA9841 (rubber) (230 x 96 x 35) REF 143TA9843 (steel)
<i>S/N: 17914 - and up</i>				
REF 143TA8721 (for rubber and steel tracks) (Ø flange = 96,00 mm) (Ø body = 80,00 mm)		REF 143TA9154 (number of teeth = 19) (number of holes = 9)	REF 143TA9434 (front, with bracket assembly) (for rubber tracks) (Ø = 266,00 mm) REF 143TA9435 (front, with bracket assembly) (for steel tracks) (Ø = 266,00 mm)	REF 143TA9842 (rubber) (230 x 96 x 35) REF 143TA9843 (steel)
KOMATSU PC18MR-3				
<i>S/N: 20001 - 20751</i>				
REF 143TA8721 (Ø flange = 96,00 mm) (Ø body = 80,00 mm)		REF 143TA9154 (number of teeth = 19) (number of holes = 9)	REF 143TA9437 (front, with bracket assembly) (for rubber tracks) (Ø = 266,00 mm) REF 143TA9439 (front, with bracket assembly) (for steel tracks) (Ø = 266,00 mm)	REF 143TA9842 (rubber) (230 x 96 x 35) REF 164TA9669 (steel)
<i>S/N: 20001 - and up</i>				
REF 143TA8721 (Ø flange = 96,00 mm) (Ø body = 80,00 mm)		REF 143TA9154 (number of teeth = 19) (number of holes = 9)		REF 143TA9842 (rubber) (230 x 96 x 35) REF 164TA9669 (steel)
<i>S/N: 20366 - 20751</i>				
		REF 143TA9154 (number of teeth = 19) (number of holes = 9)	REF 143TA9439 (front, with bracket assembly) (for steel tracks) (variable gauge) (Ø = 266,00 mm)	REF 143TA9842 (rubber) (230 x 96 x 35)
<i>S/N: 20366 - and up</i>				
		REF 143TA9154 (number of teeth = 19) (number of holes = 9)	REF 163TA9556 (front, with bracket assembly) (for rubber tracks) (variable gauge)	REF 143TA9842 (rubber) (230 x 96 x 35)
<i>S/N: 20752 - and up</i>				
		REF 143TA9154 (number of teeth = 19) (number of holes = 9)	REF 143TA9438 (front, with bracket assembly) (for rubber tracks) (Ø = 266,00 mm) REF 143TA9440 (front, with bracket assembly) (for steel tracks) (for variable and non-variable gauge)	REF 143TA9842 (rubber) (230 x 96 x 35)



used for KOMATSU				
TRACK ROLLER	TOP ROLLER	SPROCKET	IDLER	TRACK
				
<i>S/N: F30001 - and up</i>				
		REF 143TA9154 (number of teeth = 19) (number of holes = 9)	REF 143TA9438 (front, with bracket assembly) (for rubber tracks) (Ø = 266,00 mm) REF 143TA9441 (front, with bracket assembly) (for steel tracks)	REF 143TA9844 (steel) REF 143TA9842 (rubber) (230 x 96 x 35)
KOMATSU PC20-3				
<i>S/N: 14001 - and up</i>				
REF 143TA8704 (Ø flange = 115,00 mm) (Ø body = 85,00 mm)	REF 143TA8945 (assembly)	REF 143TA9155	REF 143TA9572 (front, with bracket assembly) (Ø = 266,00 mm) REF 143TA9573 (front, with bracket assembly) REF 143TA9574 (front, with bracket assembly)	REF 163TA9530 (steel) (width = 300,00 mm) REF 163TA9531 (steel) (width = 400,00 mm)
KOMATSU PC20-5				
<i>S/N: 18001 - 20987</i>				
		REF 143TA9156 (for rubber tracks) REF 143TA9155 (for steel tracks)	REF 143TA8974 (front, with bracket assembly) (for rubber tracks)	REF 163TA9530 (steel) (width = 300,00 mm)
<i>S/N: 18001 - 21753</i>				
REF 143TA8722 (for rubber tracks) REF 143TA8724 (for steel tracks) (Ø flange = 115,00 mm) (Ø body = 85,00 mm)		REF 143TA9156 (for rubber tracks) REF 143TA9155 (for steel tracks)	REF 143TA9415 (front, with bracket assembly) (for steel tracks) REF 143TA8974 (front, with bracket assembly) (for rubber tracks)	
<i>S/N: 18001 - 22173</i>				
				REF 163TA9531 (steel) (width = 400,00 mm)
<i>S/N: 20988 - 22173</i>				
		REF 143TA9156 (for rubber tracks) REF 143TA9155 (for steel tracks)	REF 143TA8974 (front, with bracket assembly) (for rubber tracks)	REF 164TA2055 (steel) (width = 300,00 mm)
<i>S/N: 21754 - and up</i>				
REF 143TA8723 (for rubber tracks) REF 143TA8725 (for steel tracks) (Ø flange = 145,00 mm) (Ø body = 85,00 mm)		REF 143TA9156 (for rubber tracks) REF 143TA9155 (for steel tracks)	REF 143TA9442 (front, with bracket assembly) (for steel tracks) REF 143TA8974 (front, with bracket assembly) (for rubber tracks)	
<i>S/N: 22174 - and up</i>				
		REF 143TA9156 (for rubber tracks) REF 143TA9155 (for steel tracks)	REF 143TA8974 (front, with bracket assembly) (for rubber tracks)	REF 163TA9532 (steel) (width = 300,00 mm) REF 163TA9533 (steel) (width = 300,00 mm)



used for KOMATSU				
TRACK ROLLER	TOP ROLLER	SPROCKET	IDLER	TRACK
				

KOMATSU PC20-6				
<i>S/N: 24001 - 26000</i>				
REF 143TA8726 (∅ flange = 145,00 mm) (∅ body = 85,00 mm)		REF 143TA9171		
<i>S/N: 24001 - 28042</i>				
REF 143TA8726 (∅ flange = 145,00 mm) (∅ body = 85,00 mm)				REF 143TA9846 (rubber) (300 x 52,5 x 84) (with rail) REF 163TA9534 (steel) (width = 300,00 mm) REF 163TA9536 (steel) (width = 400,00 mm)
<i>S/N: 24001 - 29360</i>				
REF 143TA8726 (∅ flange = 145,00 mm) (∅ body = 85,00 mm)			REF 143TA9443 (front, with bracket assembly)	
<i>S/N: 26001 - and up</i>				
REF 143TA8726 (∅ flange = 145,00 mm) (∅ body = 85,00 mm)		REF 143TA9165		
<i>S/N: 28043 - and up</i>				
REF 143TA8726 (∅ flange = 145,00 mm) (∅ body = 85,00 mm)				REF 143TA9847 (rubber) (300 x 52,5 x 84) (with rail) REF 163TA9535 (steel) (width = 300,00 mm) REF 163TA9537 (steel) (width = 400,00 mm)
<i>S/N: 29361 - and up</i>				
REF 143TA8726 (∅ flange = 145,00 mm) (∅ body = 85,00 mm)			REF 143TA9444 (front, with bracket assembly) (∅ = 338,00 mm)	
KOMATSU PC20-7				
<i>S/N: 35001 - 42354</i>				
REF 143TA8715 (for rubber tracks) (∅ flange = 145,00 mm) (∅ body = 85,00 mm) REF 143TA8707 (for steel tracks) (∅ flange = 115,00 mm) (∅ body = 85,00 mm)	REF 143TA8941 (assembly) (for rubber tracks) (∅ flange = 130,00 mm) (∅ body = 72,00 mm) REF 143TA8942 (assembly) (for steel tracks) (∅ body = 70,00 mm)	REF 143TA9159	REF 143TA9418 (front, with bracket assembly) (for rubber tracks) (∅ = 338,00 mm) REF 143TA9420 (front, with bracket assembly) (for steel tracks) (∅ = 338,00 mm)	REF 143TA9834 (rubber) (300 x 109 x 39) (with rail) REF 163TA9524 (steel) (width = 300,00 mm) REF 163TA9528 (steel) (width = 350,00 mm)
<i>S/N: 35001 - and up</i>				
	REF 143TA8941 (assembly) (for rubber tracks) (∅ flange = 130,00 mm) (∅ body = 72,00 mm) REF 143TA8942 (assembly) (for steel tracks) (∅ body = 70,00 mm)		REF 143TA9418 (front, with bracket assembly) (for rubber tracks) (∅ = 338,00 mm) REF 143TA9420 (front, with bracket assembly) (for steel tracks) (∅ = 338,00 mm)	REF 163TA9524 (steel) (width = 300,00 mm) REF 163TA9528 (steel) (width = 350,00 mm)



used for KOMATSU				
TRACK ROLLER	TOP ROLLER	SPROCKET	IDLER	TRACK
				
<i>S/N: 42355 - and up</i>				
REF 143TA8708 (for steel tracks) (∅ flange = 108,00 mm) (∅ body = 85,00 mm)		REF 143TA9160 (number of teeth = 23) (number of holes = 9)		REF 143TA9835 (rubber) (300 x 52,5 x 80)
<i>S/N: F20001 - F20418</i>				
REF 143TA8710 (for steel tracks) (∅ flange = 115,00 mm) (∅ body = 85,00 mm)	REF 143TA8943 (assembly) (for rubber tracks) (∅ flange = 130,00 mm) (∅ body = 72,00 mm)	REF 143TA9148 (number of teeth = 23) (number of holes = 9)	REF 143TA9421 (front, with bracket assembly) (for rubber tracks)	REF 143TA9848 (rubber) (300 x 109 x 39) (with rail)
REF 143TA8709 (for rubber tracks) (∅ flange = 145,00 mm) (∅ body = 85,00 mm)	REF 143TA8944 (assembly) (for steel tracks) (∅ body = 70,00 mm)		REF 143TA9422 (front, with bracket assembly) (for steel tracks)	REF 164TA2056 (steel) (width = 300,00 mm)
<i>S/N: F20419 - and up</i>				
REF 164TA2105 (for rubber tracks)	REF 143TA8944 (assembly) (for rubber tracks) (∅ body = 70,00 mm)	REF 143TA9148 (number of teeth = 23) (number of holes = 9)	REF 143TA9423 (front, with bracket assembly) (for rubber and steel tracks)	REF 143TA9849 (rubber) (300 x 55 x 78)
REF 164TA2105 (for steel tracks)				REF 164TA2056 (steel) (width = 300,00 mm)
KOMATSU PC20FR-2				
<i>S/N: 20001 - and up</i>				
REF 164TA2106 (∅ flange = 110,00 mm) (∅ body = 70,00 mm)		REF 164TA2081 (number of teeth = 23) (number of holes = 9)	REF 144TA4487 (front, with bracket assembly) (for rubber tracks) REF 164TA2137 (front, with bracket assembly) (for steel tracks)	REF 164TA2038 (rubber) (250 x 48,5 x 84) REF 164TA2057 (steel)
KOMATSU PC20MR-1				
<i>S/N: 10001 - 11878</i>				
REF 143TA8728 (∅ flange = 108,00 mm) (∅ body = 85,00 mm)		REF 143TA9162 (number of teeth = 23) (number of holes = 9)	REF 143TA9447 (front, with bracket assembly)	REF 143TA9856 (rubber) (250 x 52,5 x 78) REF 163TA9538 (steel) (width = 250,00 mm)
<i>S/N: 11879 - and up</i>				
			REF 143TA9448 (front, with bracket assembly)	REF 143TA9856 (rubber) (250 x 52,5 x 78) REF 163TA9538 (steel) (width = 250,00 mm)
KOMATSU PC20MR-2				
<i>S/N: 15001 - 16879</i>				
REF 143TA8728 (∅ flange = 108,00 mm) (∅ body = 85,00 mm)		REF 143TA9162 (number of teeth = 23) (number of holes = 9)	REF 143TA9449 (front, with bracket assembly)	REF 143TA9852 (rubber) (250 x 52,5 x 78) REF 163TA9538 (steel) (width = 250,00 mm)
<i>S/N: 16880 - 17569</i>				
REF 143TA8728 (∅ flange = 108,00 mm) (∅ body = 85,00 mm)		REF 143TA9162 (number of teeth = 23) (number of holes = 9)	REF 143TA9449 (front, with bracket assembly)	REF 143TA9853 (rubber) (250 x 52,5 x 78) REF 163TA9538 (steel) (width = 250,00 mm)



used for KOMATSU				
TRACK ROLLER	TOP ROLLER	SPROCKET	IDLER	TRACK
				
<i>S/N: 117570 - and up</i>				
REF 143TA8728 (∅ flange = 108,00 mm) (∅ body = 85,00 mm)		REF 143TA9162 (number of teeth = 23) (number of holes = 9)	REF 143TA9449 (front, with bracket assembly)	REF 143TA9854 (rubber) (300 x 55 x 74) REF 163TA9538 (steel) (width = 250,00 mm)
<i>S/N: F00003 - and up</i>				
REF 143TA8729 (∅ flange = 108,00 mm) (∅ body = 85,00 mm)		REF 143TA9162 (number of teeth = 23) (number of holes = 9)	REF 143TA9450 (front, with bracket assembly)	REF 164TA2058 (steel) (width = 250,00 mm)
KOMATSU PC20MR-2A				
<i>S/N: 15001 - and up</i>				
REF 143TA8728 (∅ flange = 108,00 mm) (∅ body = 85,00 mm)		REF 143TA9163	REF 143TA9449 (front, with bracket assembly)	REF 143TA9857 (rubber) (250 x 52,5 x 78) REF 163TA9538 (steel) (width = 250,00 mm)
KOMATSU PC20MR-2B				
<i>S/N: 15001 - and up</i>				
REF 143TA8728 (∅ flange = 108,00 mm) (∅ body = 85,00 mm)		REF 143TA9163	REF 143TA9449 (front, with bracket assembly)	REF 143TA9857 (rubber) (250 x 52,5 x 78) REF 163TA9538 (steel) (width = 250,00 mm)
KOMATSU PC20MR-3				
<i>S/N: 20001 - and up</i>				
REF 143TA8728 (∅ flange = 108,00 mm) (∅ body = 85,00 mm)		REF 143TA9162 (number of teeth = 23) (number of holes = 9)	REF 143TA9451 (front, with bracket assembly)	REF 143TA9855 (rubber) (250 x 52,5 x 78)
KOMATSU PC20MRX-1				
<i>S/N: 10001 - 11878</i>				
REF 143TA8728 (∅ flange = 108,00 mm) (∅ body = 85,00 mm)		REF 143TA9162 (number of teeth = 23) (number of holes = 9)	REF 143TA9447 (front, with bracket assembly)	REF 163TA9538 (steel) (width = 250,00 mm)
<i>S/N: 10001 - 12633</i>				
REF 143TA8728 (∅ flange = 108,00 mm) (∅ body = 85,00 mm)		REF 143TA9162 (number of teeth = 23) (number of holes = 9)		REF 143TA9856 (rubber) (250 x 52,5 x 78) REF 163TA9538 (steel) (width = 250,00 mm)
<i>S/N: 11879 - and up</i>				
REF 143TA8728 (∅ flange = 108,00 mm) (∅ body = 85,00 mm)		REF 143TA9162 (number of teeth = 23) (number of holes = 9)	REF 143TA9448 (front, with bracket assembly)	REF 163TA9538 (steel) (width = 250,00 mm)
<i>S/N: 12634 - and up</i>				
REF 143TA8728 (∅ flange = 108,00 mm) (∅ body = 85,00 mm)		REF 143TA9162 (number of teeth = 23) (number of holes = 9)		REF 143TA9854 (rubber) (300 x 55 x 74) REF 163TA9538 (steel) (width = 250,00 mm)
KOMATSU PC20R-8				
<i>S/N: 10001 - and up</i>				
REF 143TA8711 (∅ flange = 108,00 mm) (∅ body = 85,00 mm)		REF 143TA9164	REF 143TA9452 (front, with bracket assembly)	REF 143TA9815 (rubber) (260 x 109 x 37)





TRACKS & UNDERCARRIAGE PARTS



used for KOMATSU

used for KOMATSU				
TRACK ROLLER	TOP ROLLER	SPROCKET	IDLER	TRACK
				
				REF 143TA9826 (steel) (width = 250,00 mm) (number of links = 38)
<i>S/N: F30001 - F30542</i>				
REF 143TA8730 (∅ flange = 108,00 mm) (∅ body = 85,00 mm)		REF 143TA9148 (number of teeth = 23) (number of holes = 9)	REF 143TA9589 (front, with bracket assembly) (for rubber tracks) (LH) REF 143TA9603 (front, with bracket assembly) (for rubber tracks) (RH)	REF 143TA9818 (rubber) (250 x 52,5 x 76) REF 143TA9817 (steel) (width = 300,00 mm) (number of links = 38)
<i>S/N: F30001 - F30543</i>				
REF 143TA8730 (∅ flange = 108,00 mm) (∅ body = 85,00 mm)		REF 143TA9148 (number of teeth = 23) (number of holes = 9)	REF 164TA2138 (front, with bracket assembly) (for steel tracks) (LH) REF 164TA2139 (front, with bracket assembly) (for steel tracks) (RH)	REF 143TA9818 (rubber) (250 x 52,5 x 76) REF 143TA9817 (steel) (width = 300,00 mm) (number of links = 38)
<i>S/N: F30543 - and up</i>				
REF 143TA8730 (∅ flange = 108,00 mm) (∅ body = 85,00 mm)		REF 143TA9148 (number of teeth = 23) (number of holes = 9)	REF 143TA9590 (front, with bracket assembly) (for rubber tracks) (LH) REF 143TA9604 (front, with bracket assembly) (for rubber tracks) (RH)	REF 143TA9818 (rubber) (250 x 52,5 x 76) REF 143TA9817 (steel) (width = 300,00 mm) (number of links = 38)
<i>S/N: F30544 - and up</i>				
REF 143TA8730 (∅ flange = 108,00 mm) (∅ body = 85,00 mm)		REF 143TA9148 (number of teeth = 23) (number of holes = 9)	REF 164TA2140 (front, with bracket assembly) (for steel tracks) (LH) REF 164TA2141 (front, with bracket assembly) (for steel tracks) (RH)	REF 143TA9818 (rubber) (250 x 52,5 x 76) REF 143TA9817 (steel) (width = 300,00 mm) (number of links = 38)
KOMATSU PC20UU-3				
<i>S/N: 10001 - 10813</i>				
REF 143TA8728 (∅ flange = 108,00 mm) (∅ body = 85,00 mm)		REF 143TA9162 (number of teeth = 23) (number of holes = 9)	REF 143TA9447 (front, with bracket assembly)	REF 143TA9856 (rubber) (250 x 52,5 x 78) REF 163TA9538 (steel) (width = 250,00 mm)
<i>S/N: 10814 - and up</i>				
REF 143TA8728 (∅ flange = 108,00 mm) (∅ body = 85,00 mm)		REF 143TA9162 (number of teeth = 23) (number of holes = 9)	REF 143TA9448 (front, with bracket assembly)	REF 143TA9856 (rubber) (250 x 52,5 x 78) REF 163TA9538 (steel) (width = 250,00 mm)
KOMATSU PC25-1				
<i>S/N: 01001 - 06470</i>				
REF 143TA8726 (for rubber tracks) (∅ flange = 145,00 mm) (∅ body = 85,00 mm) REF 143TA8731 (for steel tracks) (∅ flange = 115,00 mm) (∅ body = 85,00 mm)	REF 143TA8947 (for rubber tracks) REF 143TA8938 (for steel tracks)		REF 143TA9454 (front, with bracket assembly) (for rubber tracks) (∅ = 338,00 mm) REF 143TA9453 (front, with bracket assembly) (for steel tracks)	REF 143TA9858 (rubber) (300 x 109 x 41) (with rail) REF 163TA9539 (steel) (width = 300,00 mm)







used for KOMATSU				
TRACK ROLLER	TOP ROLLER	SPROCKET	IDLER	TRACK
				
				REF 163TA9537 (steel) (width = 400,00 mm)
<i>S/N: 01001 - 07094</i>				
		REF 143TA9165 (number of teeth = 23) (number of holes = 9)		REF 163TA9539 (steel) (width = 300,00 mm)
				REF 163TA9537 (steel) (width = 400,00 mm)
<i>S/N: 06471 - 07046</i>				
				REF 143TA9862 (rubber) (300 x 52,5, x 84)
				REF 163TA9539 (steel) (width = 300,00 mm)
				REF 163TA9537 (steel) (width = 400,00 mm)
<i>S/N: 06471 - and up</i>				
REF 143TA8732 (Ø flange = 115,00 mm) (Ø body = 85,00 mm)	REF 143TA8938		REF 143TA9454 (front, with bracket assembly) (Ø = 338,00 mm)	REF 163TA9539 (steel) (width = 300,00 mm)
				REF 163TA9537 (steel) (width = 400,00 mm)
<i>S/N: 07047 - and up</i>				
				REF 143TA9863 (rubber) (300 x 52,5 x 84)
				REF 163TA9539 (steel) (width = 300,00 mm)
				REF 163TA9537 (steel) (width = 400,00 mm)
<i>S/N: 07095 - and up</i>				
		REF 143TA9166 (number of teeth = 23) (number of holes = 9)		REF 163TA9539 (steel) (width = 300,00 mm)
				REF 163TA9537 (steel) (width = 400,00 mm)
KOMATSU PC25R-1				
<i>S/N: 01001 - 06470</i>				
REF 143TA8726 (for rubber tracks) (Ø flange = 145,00 mm) (Ø body = 85,00 mm)	REF 143TA8947 (for rubber tracks)		REF 143TA9454 (front, with bracket assembly) (for rubber tracks) (Ø = 338,00 mm)	REF 143TA9858 (rubber) (300 x 109 x 41) (with rail)
REF 143TA8731 (for steel tracks) (Ø flange = 115,00 mm) (Ø body = 85,00 mm)	REF 143TA8938 (for steel tracks)		REF 143TA9453 (front, with bracket assembly) (for steel tracks)	REF 163TA9539 (steel) (width = 300,00 mm)
				REF 163TA9537 (steel) (width = 400,00 mm)
<i>S/N: 01001 - 07094</i>				
		REF 143TA9165 (number of teeth = 23) (number of holes = 9)		REF 163TA9539 (steel) (width = 300,00 mm)
				REF 163TA9537 (steel) (width = 400,00 mm)
<i>S/N: 06470 - 07046</i>				
				REF 143TA9862 (rubber) (300 x 52,5, x 84)

TRACKS & UNDERCARRIAGE PARTS



used for KOMATSU

used for KOMATSU				
TRACK ROLLER	TOP ROLLER	SPROCKET	IDLER	TRACK
				
				REF 163TA9539 (steel) (width = 300,00 mm) REF 163TA9537 (steel) (width = 400,00 mm)
<i>S/N: 06471 - and up</i>				
REF 143TA8732 (∅ flange = 115,00 mm) (∅ body = 85,00 mm)	REF 143TA8938		REF 143TA9454 (front, with bracket assembly) (∅ = 338,00 mm)	REF 163TA9539 (steel) (width = 300,00 mm) REF 163TA9537 (steel) (width = 400,00 mm)
<i>S/N: 07047 - and up</i>				
				REF 143TA9863 (rubber) (300 x 52,5 x 84) REF 163TA9539 (steel) (width = 300,00 mm) REF 163TA9537 (steel) (width = 400,00 mm)
<i>S/N: 07095 - and up</i>				
		REF 143TA9166 (number of teeth = 23) (number of holes = 9)		REF 163TA9539 (steel) (width = 300,00 mm) REF 163TA9537 (steel) (width = 400,00 mm)
KOMATSU PC25R-8				
<i>S/N: 10001 - and up</i>				
REF 143TA8711 (∅ flange = 108,00 mm) (∅ body = 85,00 mm)	REF 143TA8942	REF 143TA9147 (number of teeth = 23) (number of holes = 9)	REF 143TA9455 (front, with bracket assembly) (∅ = 338,00 mm)	REF 143TA9835 (rubber) (300 x 52,5 x 80) REF 163TA9540 (steel) (width = 300,00 mm) REF 163TA9528 (steel) (width = 350,00 mm)
KOMATSU PC26MR-3				
<i>S/N: F30003 - and up</i>				
REF 143TA8729 (∅ flange = 108,00 mm) (∅ body = 85,00 mm)		REF 143TA9167 (number of teeth = 23) (number of holes = 12)	REF 143TA9450 (front, with bracket assembly)	REF 143TA9859 (rubber) (300 x 52,5 x 80) REF 164TA2052 (rubber) (300 x 52,5 x 80)
KOMATSU PC27MR-1				
<i>S/N: 10001 - and up</i>				
REF 143TA8728 (∅ flange = 108,00 mm) (∅ body = 85,00 mm)	REF 143TA8946	REF 143TA9168 (number of teeth = 23) (number of holes = 9)	REF 143TA9448 (front, with bracket assembly)	REF 143TA9860 (rubber) (300 x 52,5 x 80) REF 163TA9540 (steel) (width = 300,00 mm)
KOMATSU PC27MR-2				
<i>S/N: 15001 - and up</i>				
REF 143TA8728 (∅ flange = 108,00 mm) (∅ body = 85,00 mm)	REF 143TA8948	REF 143TA9167 (number of teeth = 23) (number of holes = 12)	REF 143TA9449 (front, with bracket assembly)	REF 143TA9859 (rubber) (300 x 52,5 x 80) REF 163TA9540 (steel) (width = 300,00 mm)



used for KOMATSU				
TRACK ROLLER	TOP ROLLER	SPROCKET	IDLER	TRACK
				
<i>S/N: F00103 - F00148</i>				
REF 143TA8729 (∅ flange = 108,00 mm) (∅ body = 85,00 mm)	REF 143TA8949	REF 143TA9167 (number of teeth = 23) (number of holes = 12)	REF 143TA9450 (front, with bracket assembly)	REF 164TA2051 (steel) REF 143TA9859 (rubber) (300 x 52,5 x 80)
<i>S/N: F00149 - and up</i>				
REF 143TA8729 (∅ flange = 108,00 mm) (∅ body = 85,00 mm)	REF 143TA8949	REF 143TA9169	REF 143TA9450 (front, with bracket assembly)	REF 164TA2052 (rubber) (300 x 52,5 x 80) REF 143TA9859 (rubber) (300 x 52,5 x 80)
KOMATSU PC27MR-2A				
<i>S/N: 15001 - and up</i>				
REF 143TA8728 (∅ flange = 108,00 mm) (∅ body = 85,00 mm)	REF 143TA8948	REF 143TA9167 (number of teeth = 23) (number of holes = 12)	REF 143TA9449 (front, with bracket assembly)	REF 143TA9859 (rubber) (300 x 52,5 x 80) REF 163TA9540 (steel) (width = 300,00 mm)
KOMATSU PC27MR-2B				
<i>S/N: 15001 - and up</i>				
REF 143TA8728 (∅ flange = 108,00 mm) (∅ body = 85,00 mm)	REF 143TA8948	REF 143TA9167 (number of teeth = 23) (number of holes = 12)	REF 143TA9449 (front, with bracket assembly)	REF 143TA9859 (rubber) (300 x 52,5 x 80) REF 163TA9540 (steel) (width = 300,00 mm)
KOMATSU PC27MR-3				
<i>S/N: 20002 - and up</i>				
REF 143TA8728 (∅ flange = 108,00 mm) (∅ body = 85,00 mm)	REF 143TA8948	REF 143TA9167 (number of teeth = 23) (number of holes = 12)	REF 143TA9449 (front, with bracket assembly)	REF 143TA9859 (rubber) (300 x 52,5 x 80)
<i>S/N: 20509 - and up</i>				
REF 143TA8728 (∅ flange = 108,00 mm) (∅ body = 85,00 mm)	REF 143TA8948	REF 143TA9167 (number of teeth = 23) (number of holes = 12)	REF 143TA9449 (front, with bracket assembly)	REF 143TA9859 (rubber) (300 x 52,5 x 80) REF 163TA9540 (steel) (width = 300,00 mm)
KOMATSU PC27MRX-1				
<i>S/N: 10001 - and up</i>				
REF 143TA8728 (∅ flange = 108,00 mm) (∅ body = 85,00 mm)	REF 143TA8948	REF 143TA9168 (number of teeth = 23) (number of holes = 9)	REF 143TA9448 (front, with bracket assembly)	REF 143TA9860 (rubber) (300 x 52,5 x 80) REF 163TA9540 (steel) (width = 300,00 mm)
KOMATSU PC27R-8				
<i>S/N: 10001 - and up</i>				
REF 143TA8711 (∅ flange = 108,00 mm) (∅ body = 85,00 mm)	REF 143TA8942	REF 143TA9147 (number of teeth = 23) (number of holes = 9)	REF 143TA9455 (front, with bracket assembly) (∅ = 338,00 mm)	REF 143TA9835 (rubber) (300 x 52,5 x 80) REF 163TA9540 (steel) (width = 300,00 mm)

TRACKS & UNDERCARRIAGE PARTS



used for KOMATSU

used for KOMATSU				
TRACK ROLLER	TOP ROLLER	SPROCKET	IDLER	TRACK
				
<i>S/N: F30001 - F30691</i>				
REF 143TA8730 (∅ flange = 108,00 mm) (∅ body = 85,00 mm)	REF 143TA8944	REF 143TA9148 (number of teeth = 23) (number of holes = 9)	REF 164TA2138 (front, with bracket assembly) (for steel tracks) (LH) REF 164TA2139 (front, with bracket assembly) (for steel tracks) (RH)	REF 143TA9861 (rubber) (300 x 109 x 39) REF 164TA2056 (steel) (width = 300,00 mm)
<i>S/N: F30001 - F30695</i>				
REF 143TA8730 (∅ flange = 108,00 mm) (∅ body = 85,00 mm)	REF 143TA8944	REF 143TA9148 (number of teeth = 23) (number of holes = 9)	REF 143TA9589 (front, with bracket assembly) (for rubber tracks) (LH) REF 143TA9603 (front, with bracket assembly) (for rubber tracks) (RH)	REF 143TA9861 (rubber) (300 x 109 x 39) REF 164TA2056 (steel) (width = 300,00 mm)
<i>S/N: F30692 - and up</i>				
REF 143TA8730 (∅ flange = 108,00 mm) (∅ body = 85,00 mm)	REF 143TA8944	REF 143TA9148 (number of teeth = 23) (number of holes = 9)	REF 164TA2140 (front, with bracket assembly) (for steel tracks) (LH) REF 164TA2141 (front, with bracket assembly) (for steel tracks) (RH)	REF 143TA9861 (rubber) (300 x 109 x 39) REF 164TA2056 (steel) (width = 300,00 mm)
<i>S/N: F30696 - and up</i>				
REF 143TA8730 (∅ flange = 108,00 mm) (∅ body = 85,00 mm)	REF 143TA8944	REF 143TA9148 (number of teeth = 23) (number of holes = 9)	REF 143TA9590 (front, with bracket assembly) (for rubber tracks) (LH) REF 143TA9604 (front, with bracket assembly) (for rubber tracks) (RH)	REF 143TA9861 (rubber) (300 x 109 x 39) REF 164TA2056 (steel) (width = 300,00 mm)
KOMATSU PC28UD-2				
<i>S/N: 07001 - 10800</i>				
REF 143TA8715 (for rubber tracks) (∅ flange = 145,00 mm) (∅ body = 85,00 mm)	REF 143TA8941 (for rubber tracks)	REF 143TA9159	REF 143TA9418 (front, with bracket assembly) (for rubber tracks) (∅ = 338,00 mm) REF 143TA9419 (front, with bracket assembly) (for steel tracks) (∅ = 338,00 mm)	REF 143TA9834 (rubber) (300 x 109 x 39) (with rail) REF 163TA9524 (steel) (width = 300,00 mm) REF 163TA9528 (steel) (width = 350,00 mm)
REF 143TA8707 (for steel tracks) (∅ flange = 115,00 mm) (∅ body = 85,00 mm)	REF 143TA8942 (for steel tracks)			
<i>S/N: 10801 - and up</i>				
REF 143TA8711 (∅ flange = 108,00 mm) (∅ body = 85,00 mm)	REF 143TA8942	REF 143TA9160 (number of teeth = 23) (number of holes = 9)	REF 143TA9420 (front, with bracket assembly) (∅ = 338,00 mm)	REF 143TA9835 (rubber) (300 x 52,5 x 80) REF 163TA9524 (steel) (width = 300,00 mm) REF 163TA9528 (steel) (width = 350,00 mm)
KOMATSU PC28UG-2				
<i>S/N: 07001 - 10800</i>				
REF 143TA8715 (for rubber tracks) (∅ flange = 145,00 mm) (∅ body = 85,00 mm)	REF 143TA8941 (for rubber tracks)	REF 143TA9159	REF 143TA9418 (front, with bracket assembly) (for rubber tracks) (∅ = 338,00 mm)	REF 143TA9834 (rubber) (300 x 109 x 39) (with rail)







used for KOMATSU				
TRACK ROLLER	TOP ROLLER	SPROCKET	IDLER	TRACK
				
REF 143TA8707 (for steel tracks) (Ø flange = 115,00 mm) (Ø body = 85,00 mm)	REF 143TA8942 (for steel tracks)		REF 143TA9419 (front, with bracket assembly) (for steel tracks) (Ø = 338,00 mm)	REF 163TA9524 (steel) (width = 300,00 mm) REF 163TA9528 (steel) (width = 350,00 mm)
<i>S/N: 10801 - and up</i>				
REF 143TA8711 (Ø flange = 108,00 mm) (Ø body = 85,00 mm)	REF 143TA8942	REF 143TA9160 (number of teeth = 23) (number of holes = 9)	REF 143TA9420 (front, with bracket assembly) (Ø = 338,00 mm)	REF 143TA9835 (rubber) (300 x 52,5 x 80) REF 163TA9524 (steel) (width = 300,00 mm) REF 163TA9528 (steel) (width = 350,00 mm)
KOMATSU PC28UU-2				
<i>S/N: 07001 - 10800</i>				
REF 143TA8715 (for rubber tracks) (Ø flange = 145,00 mm) (Ø body = 85,00 mm)	REF 143TA8941 (for rubber tracks)	REF 143TA9159	REF 143TA9418 (front, with bracket assembly) (for rubber tracks) (Ø = 338,00 mm)	REF 143TA9834 (rubber) (300 x 109 x 39) (with rail)
REF 143TA8707 (for steel tracks) (Ø flange = 115,00 mm) (Ø body = 85,00 mm)	REF 143TA8942 (for steel tracks)		REF 143TA9419 (front, with bracket assembly) (for steel tracks) (Ø = 338,00 mm)	REF 163TA9524 (steel) (width = 300,00 mm) REF 163TA9528 (steel) (width = 350,00 mm)
<i>S/N: 10801 - and up</i>				
REF 143TA8711 (Ø flange = 108,00 mm) (Ø body = 85,00 mm)	REF 143TA8942	REF 143TA9160 (number of teeth = 23) (number of holes = 9)	REF 143TA9420 (front, with bracket assembly) (Ø = 338,00 mm)	REF 143TA9835 (rubber) (300 x 52,5 x 80) REF 163TA9524 (steel) (width = 300,00 mm) REF 163TA9528 (steel) (width = 350,00 mm)
KOMATSU PC28UU-3				
<i>S/N: 30001 - and up</i>				
REF 143TA8728 (Ø flange = 108,00 mm) (Ø body = 85,00 mm)	REF 143TA8950	REF 143TA9168 (number of teeth = 23) (number of holes = 9)	REF 143TA9448 (front, with bracket assembly)	REF 143TA9860 (rubber) (300 x 52,5 x 80) REF 163TA9540 (steel) (width = 300,00 mm)
KOMATSU PC30-1				
<i>S/N: 01001 - and up</i>				
REF 143TA8704 (Ø flange = 115,00 mm) (Ø body = 85,00 mm)		REF 143TA9170	REF 143TA9456 (front, with bracket assembly)	REF 163TA9530 (steel) (width = 300,00 mm)
KOMATSU PC30-3				
<i>S/N: 02601 - and up</i>				
REF 143TA8704 (Ø flange = 115,00 mm) (Ø body = 85,00 mm)	REF 143TA8945	REF 143TA9155	REF 143TA9574 (front, with bracket assembly)	REF 163TA9530 (steel) (width = 300,00 mm)
KOMATSU PC30-5				
<i>S/N: 06001 - 07875</i>				
		REF 143TA9155		REF 163TA9530 (steel) (width = 300,00 mm)





TRACKS & UNDERCARRIAGE PARTS



used for KOMATSU

used for KOMATSU				
TRACK ROLLER	TOP ROLLER	SPROCKET	IDLER	TRACK
				
<i>S/N: 06001 - 08418</i>				
REF 143TA8724 (Ø flange = 115,00 mm) (Ø body = 85,00 mm)		REF 143TA9155	REF 143TA9415 (front, with bracket assembly)	
<i>S/N: 07876 - 08668</i>				
		REF 143TA9155		REF 164TA2055 (steel) (width = 300,00 mm)
<i>S/N: 08419 - and up</i>				
REF 143TA8725 (Ø flange = 145,00 mm) (Ø body = 85,00 mm)		REF 143TA9155	REF 143TA9442 (front, with bracket assembly)	
<i>S/N: 08669 - and up</i>				
		REF 143TA9155		REF 163TA9532 (steel) (width = 300,00 mm)
KOMATSU PC30-6				
<i>S/N: 10001 - 11500</i>				
REF 143TA8726 (Ø flange = 145,00 mm) (Ø body = 85,00 mm)		REF 143TA9171		
<i>S/N: 10001 - 12359</i>				
REF 143TA8726 (Ø flange = 145,00 mm) (Ø body = 85,00 mm)				REF 163TA9534 (steel) (width = 300,00 mm)
<i>S/N: 10001 - 13024</i>				
REF 143TA8726 (Ø flange = 145,00 mm) (Ø body = 85,00 mm)			REF 143TA9443 (front, with bracket assembly)	REF 143TA9846 (rubber) (300 x 52,5 x 84) (with rail)
<i>S/N: 11501 - and up</i>				
REF 143TA8726 (Ø flange = 145,00 mm) (Ø body = 85,00 mm)		REF 143TA9165 (number of teeth = 23) (number of holes = 9)		
<i>S/N: 12360 - and up</i>				
REF 143TA8726 (Ø flange = 145,00 mm) (Ø body = 85,00 mm)				REF 163TA9535 (steel) (width = 300,00 mm)
<i>S/N: 13024 - and up</i>				
REF 143TA8726 (Ø flange = 145,00 mm) (Ø body = 85,00 mm)			REF 143TA9444 (front, with bracket assembly) (Ø = 338,00 mm)	
<i>S/N: 13025 - and up</i>				
REF 143TA8726 (Ø flange = 145,00 mm) (Ø body = 85,00 mm)				REF 143TA9847 (rubber) (300 x 52,5 x 84) (with rail)
KOMATSU PC30-7				
<i>S/N: 18001 - 26422</i>				
REF 143TA8726 (for rubber tracks) (Ø flange = 145,00 mm) (Ø body = 85,00 mm)	REF 143TA8947 (for rubber tracks)		REF 143TA9454 (front, with bracket assembly) (for rubber tracks) (Ø = 338,00 mm)	REF 143TA9858 (rubber) (300 x 109 x 41) (with rail)
REF 143TA8731 (for steel tracks) (Ø flange = 115,00 mm) (Ø body = 85,00 mm)	REF 143TA8938 (for steel tracks)		REF 143TA9453 (front, with bracket assembly) (for steel tracks)	REF 163TA9539 (steel) (width = 300,00 mm)
<i>S/N: 18001 - 28054</i>				
		REF 143TA9165 (number of teeth = 23) (number of holes = 9)		REF 163TA9539 (steel) (width = 300,00 mm)



used for KOMATSU				
TRACK ROLLER	TOP ROLLER	SPROCKET	IDLER	TRACK
				
<i>S/N: 26423 - 27886</i>				
				REF 143TA9862 (rubber) (300 x 52,5, x 84) REF 163TA9539 (steel) (width = 300,00 mm)
<i>S/N: 26423 - and up</i>				
REF 143TA8732 (∅ flange = 115,00 mm) (∅ body = 85,00 mm)	REF 143TA8938		REF 143TA9454 (front, with bracket assembly) (∅ = 338,00 mm)	REF 163TA9539 (steel) (width = 300,00 mm)
<i>S/N: 27887 - and up</i>				
				REF 143TA9863 (rubber) (300 x 52,5 x 84) REF 163TA9539 (steel) (width = 300,00 mm)
<i>S/N: 28055 - and up</i>				
		REF 143TA9166 (number of teeth = 23) (number of holes = 9)		REF 163TA9539 (steel) (width = 300,00 mm)
KOMATSU PC30FR-1				
<i>S/N: 10001 - 10342</i>				
REF 164TA2107 (∅ flange = 140,00 mm) (∅ body = 78,00 mm)	REF 144TA4492	REF 164TA2082 (number of teeth = 21) (number of holes = 11)	REF 164TA2143 (front, with bracket assembly) (for rubber tracks) (∅ = 332,00 mm) REF 164TA2142 (front, with bracket assembly) (for steel tracks) (∅ = 330,00 mm)	REF 164TA2064 (steel) REF 143TA9866 (rubber) (320 x 106 x 39)
<i>S/N: 10343 - and up</i>				
REF 164TA2107 (∅ flange = 140,00 mm) (∅ body = 78,00 mm)	REF 144TA4492	REF 164TA2082 (number of teeth = 21) (number of holes = 11)	REF 164TA2143 (front, with bracket assembly) (for rubber tracks) (∅ = 332,00 mm) REF 164TA2142 (front, with bracket assembly) (for steel tracks) (∅ = 330,00 mm)	REF 164TA2059 (steel) REF 143TA9866 (rubber) (320 x 106 x 39)
KOMATSU PC30FR-2				
<i>S/N: 20001 - and up</i>				
REF 164TA2108	REF 144TA4492	REF 164TA2082 (number of teeth = 21) (number of holes = 11)	REF 164TA2143 (front, with bracket assembly) (for rubber tracks) (∅ = 332,00 mm) REF 164TA2142 (front, with bracket assembly) (for steel tracks) (∅ = 330,00 mm)	REF 164TA2039 (rubber) (300 x 55,5 x 82) (offset) REF 164TA2060 (steel) (LH) REF 164TA2061 (steel) (RH)
KOMATSU PC30MR-1				
<i>S/N: 10001 - and up</i>				
REF 143TA8728 (∅ flange = 108,00 mm) (∅ body = 85,00 mm)	REF 143TA8946	REF 143TA9168 (number of teeth = 23) (number of holes = 9)	REF 143TA9448 (front, with bracket assembly)	REF 143TA9868 (rubber) (300 x 52,5 x 84)

TRACKS & UNDERCARRIAGE PARTS



used for KOMATSU

used for KOMATSU				
TRACK ROLLER	TOP ROLLER	SPROCKET	IDLER	TRACK
				
				REF 163TA9541 (steel) (width = 300,00 mm)
KOMATSU PC30MR-2				
<i>S/N: 20001 - 25876</i>				
REF 143TA8728 (∅ flange = 108,00 mm) (∅ body = 85,00 mm)	REF 143TA8948 (assembly) (∅ body = 70,00 mm)	REF 143TA9167 (number of teeth = 23) (number of holes = 12)	REF 143TA9458 (front, with bracket assembly)	REF 143TA9869 (rubber) (300 x 52,5 x 86) REF 163TA9542 (steel) (width = 300,00 mm)
<i>S/N: 25877 - and up</i>				
REF 143TA8728 (∅ flange = 108,00 mm) (∅ body = 85,00 mm)	REF 143TA8948 (assembly) (∅ body = 70,00 mm)	REF 143TA9167 (number of teeth = 23) (number of holes = 12)	REF 143TA9449 (front, with bracket assembly)	REF 143TA9869 (rubber) (300 x 52,5 x 86) REF 163TA9542 (steel) (width = 300,00 mm)
<i>S/N: F00103 - F00514</i>				
REF 143TA8729 (∅ flange = 108,00 mm) (∅ body = 85,00 mm)	REF 143TA8949 (assembly) (∅ body = 70,00 mm)	REF 143TA9167 (number of teeth = 23) (number of holes = 12)	REF 143TA9459 (front, with bracket assembly)	REF 164TA2062 (steel) REF 143TA9869 (rubber) (300 x 52,5 x 86)
<i>S/N: F00515 - and up</i>				
REF 143TA8729 (∅ flange = 108,00 mm) (∅ body = 85,00 mm)	REF 143TA8949 (assembly) (∅ body = 70,00 mm)	REF 143TA9169	REF 143TA9459 (front, with bracket assembly)	REF 164TA2063 (steel) REF 143TA9869 (rubber) (300 x 52,5 x 86)
KOMATSU PC30MR-2A				
REF 143TA8728 (∅ flange = 108,00 mm) (∅ body = 85,00 mm)	REF 143TA8948 (assembly) (∅ body = 70,00 mm)	REF 143TA9167 (number of teeth = 23) (number of holes = 12)	REF 143TA9458 (front, with bracket assembly)	REF 143TA9869 (rubber) (300 x 52,5 x 86) REF 163TA9542 (steel) (width = 300,00 mm)
KOMATSU PC30MR-2B				
REF 143TA8728 (∅ flange = 108,00 mm) (∅ body = 85,00 mm)	REF 143TA8948 (assembly) (∅ body = 70,00 mm)	REF 143TA9167 (number of teeth = 23) (number of holes = 12)	REF 143TA9458 (front, with bracket assembly)	REF 143TA9869 (rubber) (300 x 52,5 x 86) REF 163TA9542 (steel) (width = 300,00 mm)
KOMATSU PC30MR-2C				
REF 143TA8728 (∅ flange = 108,00 mm) (∅ body = 85,00 mm)	REF 143TA8948 (assembly) (∅ body = 70,00 mm)	REF 143TA9167 (number of teeth = 23) (number of holes = 12)	REF 143TA9458 (front, with bracket assembly)	REF 143TA9869 (rubber) (300 x 52,5 x 86) REF 163TA9542 (steel) (width = 300,00 mm)
KOMATSU PC30MR-2D				
REF 143TA8728 (∅ flange = 108,00 mm) (∅ body = 85,00 mm)	REF 143TA8948 (assembly) (∅ body = 70,00 mm)	REF 143TA9167 (number of teeth = 23) (number of holes = 12)	REF 143TA9458 (front, with bracket assembly)	REF 143TA9869 (rubber) (300 x 52,5 x 86) REF 163TA9542 (steel) (width = 300,00 mm)







used for KOMATSU				
TRACK ROLLER	TOP ROLLER	SPROCKET	IDLER	TRACK
				
KOMATSU PC30MR-3				
REF 143TA8728 (Ø flange = 108,00 mm) (Ø body = 85,00 mm)	REF 143TA8948 (assembly) (Ø body = 70,00 mm)	REF 143TA9167 (number of teeth = 23) (number of holes = 12)	REF 143TA9449 (front, with bracket assembly)	REF 143TA9869 (rubber) (300 x 52,5 x 86) REF 163TA9542 (steel) (width = 300,00 mm)
KOMATSU PC30MRX-1				
<i>S/N: 10001 - 13814</i>				
REF 143TA8728 (Ø flange = 108,00 mm) (Ø body = 85,00 mm)	REF 143TA8946 (assembly)	REF 143TA9168 (number of teeth = 23) (number of holes = 9)	REF 143TA9448 (front, with bracket assembly)	REF 143TA9868 (rubber) (300 x 52,5 x 84) REF 164TA2065 (steel) (width = 300,00 mm)
<i>S/N: 13815 - and up</i>				
REF 143TA8728 (Ø flange = 108,00 mm) (Ø body = 85,00 mm)	REF 143TA8948 (assembly) (Ø body = 70,00 mm)	REF 143TA9168 (number of teeth = 23) (number of holes = 9)	REF 143TA9448 (front, with bracket assembly)	REF 143TA9868 (rubber) (300 x 52,5 x 84) REF 164TA2065 (steel) (width = 300,00 mm)
KOMATSU PC30R-7				
<i>S/N: 18001 - 26422</i>				
REF 143TA8726 (for rubber tracks) (Ø flange = 145,00 mm) (Ø body = 85,00 mm) REF 143TA8731 (for steel tracks) (Ø flange = 115,00 mm) (Ø body = 85,00 mm)	REF 143TA8947 (assembly) (for rubber tracks) (Ø flange = 142,00 mm) (Ø body = 82,50 mm) REF 143TA8938 (assembly) (for steel tracks) (Ø flange = 82,00 mm) (Ø body = 35,00 mm)	REF 143TA9165 (number of teeth = 23) (number of holes = 9)	REF 143TA9454 (front, with bracket assembly) (for rubber tracks) (Ø = 338,00 mm) REF 143TA9453 (front, with bracket assembly) (for steel tracks)	REF 163TA9520 (rubber) (width = 300,00 mm) (white) REF 143TA9858 (rubber) (300 x 109 x 41) (with rail) REF 163TA9539 (steel) (width = 300,00 mm) REF 163TA9537 (steel) (width = 400,00 mm)
<i>S/N: 18001 - 28054</i>				
REF 143TA8726 (for rubber tracks) (Ø flange = 145,00 mm) (Ø body = 85,00 mm) REF 143TA8731 (for steel tracks) (Ø flange = 115,00 mm) (Ø body = 85,00 mm)	REF 143TA8947 (assembly) (for rubber tracks) (Ø flange = 142,00 mm) (Ø body = 82,50 mm) REF 143TA8938 (assembly) (for steel tracks) (Ø flange = 82,00 mm) (Ø body = 35,00 mm)	REF 143TA9165 (number of teeth = 23) (number of holes = 9)	REF 143TA9454 (front, with bracket assembly) (for rubber tracks) (Ø = 338,00 mm) REF 143TA9453 (front, with bracket assembly) (for steel tracks)	REF 163TA9539 (steel) (width = 300,00 mm) REF 163TA9537 (steel) (width = 400,00 mm)
<i>S/N: 26423 - 27886</i>				
REF 143TA8726 (for rubber tracks) (Ø flange = 145,00 mm) (Ø body = 85,00 mm) REF 143TA8731 (for steel tracks) (Ø flange = 115,00 mm) (Ø body = 85,00 mm)	REF 143TA8947 (assembly) (for rubber tracks) (Ø flange = 142,00 mm) (Ø body = 82,50 mm) REF 143TA8938 (assembly) (for steel tracks) (Ø flange = 82,00 mm) (Ø body = 35,00 mm)	REF 143TA9165 (number of teeth = 23) (number of holes = 9)	REF 143TA9454 (front, with bracket assembly) (for rubber tracks) (Ø = 338,00 mm) REF 143TA9453 (front, with bracket assembly) (for steel tracks)	REF 143TA9862 (rubber) (300 x 52,5, x 84) REF 163TA9539 (steel) (width = 300,00 mm) REF 163TA9537 (steel) (width = 400,00 mm)







used for KOMATSU				
TRACK ROLLER	TOP ROLLER	SPROCKET	IDLER	TRACK
				
<i>S/N: 27887 - and up</i>				
REF 143TA8726 (for rubber tracks) (Ø flange = 145,00 mm) (Ø body = 85,00 mm)	REF 143TA8947 (assembly) (for rubber tracks) (Ø flange = 142,00 mm) (Ø body = 82,50 mm)		REF 143TA9454 (front, with bracket assembly) (for rubber tracks) (Ø = 338,00 mm)	REF 143TA9863 (rubber) (300 x 52,5 x 84)
REF 143TA8731 (for steel tracks) (Ø flange = 115,00 mm) (Ø body = 85,00 mm)	REF 143TA8938 (assembly) (for steel tracks) (Ø flange = 82,00 mm) (Ø body = 35,00 mm)		REF 143TA9453 (front, with bracket assembly) (for steel tracks)	REF 163TA9539 (steel) (width = 300,00 mm)
				REF 163TA9537 (steel) (width = 400,00 mm)
<i>S/N: 28055 - and up</i>				
REF 143TA8726 (for rubber tracks) (Ø flange = 145,00 mm) (Ø body = 85,00 mm)	REF 143TA8947 (assembly) (for rubber tracks) (Ø flange = 142,00 mm) (Ø body = 82,50 mm)	REF 143TA9166 (number of teeth = 23) (number of holes = 9)	REF 143TA9454 (front, with bracket assembly) (for rubber tracks) (Ø = 338,00 mm)	REF 163TA9539 (steel) (width = 300,00 mm)
REF 143TA8731 (for steel tracks) (Ø flange = 115,00 mm) (Ø body = 85,00 mm)	REF 143TA8938 (assembly) (for steel tracks) (Ø flange = 82,00 mm) (Ø body = 35,00 mm)		REF 143TA9453 (front, with bracket assembly) (for steel tracks)	REF 163TA9537 (steel) (width = 400,00 mm)
KOMATSU PC30R-8				
<i>S/N: 10001 - 10529</i>				
REF 143TA8735	REF 143TA8952 (assembly) (Ø body = 70,30 mm)	REF 143TA9166 (number of teeth = 23) (number of holes = 9)	REF 143TA9460 (front, with bracket assembly)	REF 163TA9539 (steel) (width = 300,00 mm)
<i>S/N: 10001 - 11173</i>				
	REF 143TA8952 (assembly) (Ø body = 70,30 mm)	REF 143TA9166 (number of teeth = 23) (number of holes = 9)	REF 143TA9460 (front, with bracket assembly)	REF 143TA9863 (rubber) (300 x 52,5 x 84)
				REF 163TA9539 (steel) (width = 300,00 mm)
<i>S/N: 10530 - 11105</i>				
REF 143TA8736	REF 143TA8952 (assembly) (Ø body = 70,30 mm)	REF 143TA9166 (number of teeth = 23) (number of holes = 9)	REF 143TA9460 (front, with bracket assembly)	REF 163TA9539 (steel) (width = 300,00 mm)
<i>S/N: 11106 - 11147</i>				
REF 143TA8737	REF 143TA8952 (assembly) (Ø body = 70,30 mm)	REF 143TA9166 (number of teeth = 23) (number of holes = 9)	REF 143TA9460 (front, with bracket assembly)	REF 163TA9539 (steel) (width = 300,00 mm)
<i>S/N: 11148 - and up</i>				
REF 143TA8738 (Ø flange = 108,00 mm) (Ø body = 85,00 mm)	REF 143TA8952 (assembly) (Ø body = 70,30 mm)	REF 143TA9166 (number of teeth = 23) (number of holes = 9)	REF 143TA9460 (front, with bracket assembly)	REF 163TA9539 (steel) (width = 300,00 mm)
<i>S/N: 11174 - and up</i>				
	REF 143TA8952 (assembly) (Ø body = 70,30 mm)	REF 143TA9166 (number of teeth = 23) (number of holes = 9)	REF 143TA9460 (front, with bracket assembly)	REF 143TA9868 (rubber) (300 x 52,5 x 84)
				REF 163TA9539 (steel) (width = 300,00 mm)
KOMATSU PC30UU-3				
<i>S/N: 10001 - 12900</i>				
REF 143TA8728 (Ø flange = 108,00 mm) (Ø body = 85,00 mm)	REF 143TA8950 (assembly) (Ø body = 70,00 mm)	REF 143TA9168 (number of teeth = 23) (number of holes = 9)	REF 143TA9448 (front, with bracket assembly)	REF 143TA9868 (rubber) (300 x 52,5 x 84)







used for KOMATSU				
TRACK ROLLER	TOP ROLLER	SPROCKET	IDLER	TRACK
				
				REF 163TA9541 (steel) (width = 300,00 mm)
<i>S/N: 12901 - and up</i>				
REF 143TA8728 (∅ flange = 108,00 mm) (∅ body = 85,00 mm)	REF 143TA8950 (assembly) (∅ body = 70,00 mm)	REF 143TA9167 (number of teeth = 23) (number of holes = 12)	REF 143TA9458 (front, with bracket assembly)	REF 143TA9869 (rubber) (300 x 52,5 x 86) REF 163TA9542 (steel) (width = 300,00 mm)
KOMATSU PC35MR-1				
<i>S/N: 01001 - 01068</i>				
REF 143TA8737	REF 143TA8952 (assembly) (∅ body = 70,30 mm)	REF 143TA9174	REF 143TA9461 (front, with bracket assembly)	REF 163TA9539 (steel) (width = 300,00 mm)
<i>S/N: 01001 - 01584</i>				
	REF 143TA8952 (assembly) (∅ body = 70,30 mm)	REF 143TA9174	REF 143TA9461 (front, with bracket assembly)	REF 143TA9863 (rubber) (300 x 52,5 x 84) REF 163TA9539 (steel) (width = 300,00 mm)
<i>S/N: 01069 - and up</i>				
REF 143TA8738 (∅ flange = 108,00 mm) (∅ body = 85,00 mm)	REF 143TA8952 (assembly) (∅ body = 70,30 mm)	REF 143TA9174	REF 143TA9461 (front, with bracket assembly)	REF 163TA9539 (steel) (width = 300,00 mm)
<i>S/N: 01585 - and up</i>				
	REF 143TA8952 (assembly) (∅ body = 70,30 mm)	REF 143TA9174	REF 143TA9461 (front, with bracket assembly)	REF 143TA9868 (rubber) (300 x 52,5 x 84) REF 163TA9539 (steel) (width = 300,00 mm)
KOMATSU PC35MR-2				
<i>S/N: 05001 - 09241</i>				
REF 143TA8728 (∅ flange = 108,00 mm) (∅ body = 85,00 mm)	REF 143TA8948 (assembly) (∅ body = 70,00 mm)	REF 143TA9167 (number of teeth = 23) (number of holes = 12)	REF 143TA9458 (front, with bracket assembly)	REF 163TA9542 (steel) (width = 300,00 mm)
<i>S/N: 05001 - 10263</i>				
REF 143TA8728 (∅ flange = 108,00 mm) (∅ body = 85,00 mm)	REF 143TA8948 (assembly) (∅ body = 70,00 mm)	REF 143TA9167 (number of teeth = 23) (number of holes = 12)		REF 143TA9869 (rubber) (300 x 52,5 x 86) REF 163TA9542 (steel) (width = 300,00 mm)
<i>S/N: 09242 - and up</i>				
			REF 143TA9449 (front, with bracket assembly)	REF 163TA9542 (steel) (width = 300,00 mm)
<i>S/N: 10264 - and up</i>				
				REF 143TA9870 (rubber) (300 x 52,5 x 86) REF 163TA9542 (steel) (width = 300,00 mm)
<i>S/N: F00103 - F00707</i>				
REF 143TA8728 (∅ flange = 108,00 mm) (∅ body = 85,00 mm)	REF 143TA8948 (assembly) (∅ body = 70,00 mm)	REF 143TA9169	REF 143TA9458 (front, with bracket assembly)	REF 164TA2062 (steel) REF 143TA9869 (rubber) (300 x 52,5 x 86)





used for KOMATSU				
TRACK ROLLER	TOP ROLLER	SPROCKET	IDLER	TRACK
				
<i>S/N: F00708 - and up</i>				
REF 143TA8729 (∅ flange = 108,00 mm) (∅ body = 85,00 mm)	REF 143TA8949 (assembly) (∅ body = 70,00 mm)	REF 143TA9167 (number of teeth = 23) (number of holes = 12)	REF 143TA9459 (front, with bracket assembly)	REF 164TA2063 (steel) REF 143TA9869 (rubber) (300 x 52,5 x 86)
KOMATSU PC35MR-2A				
REF 143TA8728 (∅ flange = 108,00 mm) (∅ body = 85,00 mm)	REF 143TA8948 (assembly) (∅ body = 70,00 mm)	REF 143TA9167 (number of teeth = 23) (number of holes = 12)	REF 143TA9458 (front, with bracket assembly)	REF 143TA9869 (rubber) (300 x 52,5 x 86) REF 163TA9542 (steel) (width = 300,00 mm)
KOMATSU PC35MR-2B				
REF 143TA8728 (∅ flange = 108,00 mm) (∅ body = 85,00 mm)	REF 143TA8948 (assembly) (∅ body = 70,00 mm)	REF 143TA9167 (number of teeth = 23) (number of holes = 12)	REF 143TA9458 (front, with bracket assembly)	REF 143TA9869 (rubber) (300 x 52,5 x 86) REF 163TA9542 (steel) (width = 300,00 mm)
KOMATSU PC35MR-3				
REF 143TA8728 (∅ flange = 108,00 mm) (∅ body = 85,00 mm)	REF 143TA8948 (assembly) (∅ body = 70,00 mm)	REF 143TA9167 (number of teeth = 23) (number of holes = 12)	REF 143TA9449 (front, with bracket assembly)	REF 143TA9870 (rubber) (300 x 52,5 x 86) REF 163TA9542 (steel) (width = 300,00 mm)
KOMATSU PC35MRX-1A				
<i>S/N: 01001 - 01068</i>				
REF 143TA8737	REF 143TA8952 (assembly) (∅ body = 70,30 mm)			
<i>S/N: 01001 - 01584</i>				
	REF 143TA8952 (assembly) (∅ body = 70,30 mm)			REF 143TA9863 (rubber) (300 x 52,5 x 84)
<i>S/N: 01001 - 02999</i>				
	REF 143TA8952 (assembly) (∅ body = 70,30 mm)	REF 143TA9174	REF 143TA9461 (front, with bracket assembly)	
<i>S/N: 01069 - 02999</i>				
REF 143TA8738 (∅ flange = 108,00 mm) (∅ body = 85,00 mm)	REF 143TA8952 (assembly) (∅ body = 70,30 mm)			
<i>S/N: 01585 - and up</i>				
	REF 143TA8952 (assembly) (∅ body = 70,30 mm)			REF 143TA9868 (rubber) (300 x 52,5 x 84)
<i>S/N: 03001 - and up</i>				
REF 143TA8728 (∅ flange = 108,00 mm) (∅ body = 85,00 mm)	REF 143TA8952 (assembly) (∅ body = 70,30 mm)	REF 143TA9175	REF 143TA9458 (front, with bracket assembly)	
KOMATSU PC35R-8				
<i>S/N: 35001 - 36142</i>				
REF 143TA8735	REF 143TA8952 (assembly) (∅ body = 70,30 mm)	REF 143TA9166 (number of teeth = 23) (number of holes = 9)	REF 143TA9460 (front, with bracket assembly)	REF 143TA9863 (rubber) (300 x 52,5 x 84)



used for KOMATSU				
TRACK ROLLER	TOP ROLLER	SPROCKET	IDLER	TRACK
				
<i>S/N: 36143 - 37367</i>				
REF 143TA8736	REF 143TA8952 (assembly) (Ø body = 70,30 mm)	REF 143TA9166 (number of teeth = 23) (number of holes = 9)	REF 143TA9460 (front, with bracket assembly)	REF 143TA9863 (rubber) (300 x 52,5 x 84)
<i>S/N: 37368 - 37481</i>				
REF 143TA8737	REF 143TA8952 (assembly) (Ø body = 70,30 mm)	REF 143TA9166 (number of teeth = 23) (number of holes = 9)	REF 143TA9460 (front, with bracket assembly)	REF 143TA9863 (rubber) (300 x 52,5 x 84)
<i>S/N: 37482 - and up</i>				
REF 143TA8738 (Ø flange = 108,00 mm) (Ø body = 85,00 mm)	REF 143TA8952 (assembly) (Ø body = 70,30 mm)	REF 143TA9166 (number of teeth = 23) (number of holes = 9)	REF 143TA9460 (front, with bracket assembly)	REF 143TA9863 (rubber) (300 x 52,5 x 84)
<i>S/N: F20001 - F20544</i>				
REF 143TA8730 (Ø flange = 108,00 mm) (Ø body = 85,00 mm)	REF 143TA8953 (assembly) (Ø body = 70,30 mm)	REF 143TA9172 (number of teeth = 23) (number of holes = 9)	REF 143TA9462 (front, with bracket assembly)	REF 143TA9871 (rubber) (300 x 55 x 82)
<i>S/N: F20545 - and up</i>				
REF 143TA8730 (Ø flange = 108,00 mm) (Ø body = 85,00 mm)	REF 143TA8953 (assembly) (Ø body = 70,30 mm)	REF 143TA9172 (number of teeth = 23) (number of holes = 9)	REF 143TA9463 (front, with bracket assembly)	REF 143TA9871 (rubber) (300 x 55 x 82)
KOMATSU PC38UU-1				
<i>S/N: 01001 - 01059</i>				
REF 143TA8739 (Ø flange = 150,00 mm) (Ø body = 95,00 mm)		REF 143TA9176		
<i>S/N: 01001 - 01277</i>				
REF 143TA8739 (Ø flange = 150,00 mm) (Ø body = 95,00 mm)			REF 143TA9464 (front, with bracket assembly)	
<i>S/N: 01001 - 01490</i>				
REF 143TA8739 (Ø flange = 150,00 mm) (Ø body = 95,00 mm)				REF 143TA9872 (rubber) (400 x 72,5 x 70)
<i>S/N: 01060 - and up</i>				
REF 143TA8739 (Ø flange = 150,00 mm) (Ø body = 95,00 mm)		REF 143TA9177		
<i>S/N: 01278 - and up</i>				
REF 143TA8739 (Ø flange = 150,00 mm) (Ø body = 95,00 mm)			REF 143TA9465 (front, with bracket assembly) (Ø = 338,00 mm)	
<i>S/N: 01491 - 01727</i>				
REF 143TA8739 (Ø flange = 150,00 mm) (Ø body = 95,00 mm)				REF 143TA9873 (rubber) (400 x 72,5 x 70) (with rail)
<i>S/N: 01728 - and up</i>				
REF 143TA8739 (Ø flange = 150,00 mm) (Ø body = 95,00 mm)				REF 143TA9874 (rubber) (400 x 72,5 x 70) (with rail)
KOMATSU PC38UU-2				
<i>S/N: 03001 - 04482</i>				
REF 143TA8739 (Ø flange = 150,00 mm) (Ø body = 95,00 mm)	REF 143TA8947 (assembly) (Ø flange = 142,00 mm) (Ø body = 82,50 mm)	REF 143TA9165 (number of teeth = 23) (number of holes = 9)	REF 143TA9454 (front, with bracket assembly) (Ø = 338,00 mm)	REF 143TA9863 (rubber) (300 x 52,5 x 84)



used for KOMATSU				
TRACK ROLLER	TOP ROLLER	SPROCKET	IDLER	TRACK
				
<i>S/N: 04483 - and up</i>				
REF 143TA8739 (∅ flange = 150,00 mm) (∅ body = 95,00 mm)	REF 143TA8938 (assembly) (∅ flange = 82,00 mm) (∅ body = 35,00 mm)	REF 143TA9165 (number of teeth = 23) (number of holes = 9)	REF 143TA9454 (front, with bracket assembly) (∅ = 338,00 mm)	REF 143TA9863 (rubber) (300 x 52,5 x 84)
KOMATSU PC38UU-3				
<i>S/N: 07001 - 09000</i>				
REF 143TA8738 (∅ flange = 108,00 mm) (∅ body = 85,00 mm)	REF 143TA8952 (assembly) (∅ body = 70,30 mm)	REF 143TA9174	REF 143TA9461 (front, with bracket assembly)	REF 143TA9868 (rubber) (300 x 52,5 x 84)
<i>S/N: 09001 - and up</i>				
REF 143TA8738 (∅ flange = 108,00 mm) (∅ body = 85,00 mm)	REF 143TA8948 (assembly) (∅ body = 70,00 mm)	REF 143TA9167 (number of teeth = 23) (number of holes = 12)	REF 143TA9461 (front, with bracket assembly)	REF 143TA9869 (rubber) (300 x 52,5 x 84)
KOMATSU PC38UUM-2				
<i>S/N: 07001 - 09000</i>				
	REF 143TA8938 (assembly) (∅ flange = 82,00 mm) (∅ body = 35,00 mm)	REF 143TA9166 (number of teeth = 23) (number of holes = 9)	REF 143TA9454 (front, with bracket assembly) (∅ = 338,00 mm)	REF 143TA9863 (rubber) (300 x 52,5 x 84)
KOMATSU PC40-6				
<i>S/N: 10001 - 11043</i>				
REF 143TA8739 (∅ flange = 150,00 mm) (∅ body = 95,00 mm)		REF 143TA9180		
<i>S/N: 10001 - 12140</i>				
REF 143TA8739 (∅ flange = 150,00 mm) (∅ body = 95,00 mm)			REF 143TA9464 (front, with bracket assembly)	
<i>S/N: 10001 - 13054</i>				
REF 143TA8739 (∅ flange = 150,00 mm) (∅ body = 95,00 mm)				REF 143TA9872 (rubber) (400 x 72,5 x 70)
<i>S/N: 11044 - 11898</i>				
REF 143TA8739 (∅ flange = 150,00 mm) (∅ body = 95,00 mm)		REF 143TA9176		
<i>S/N: 11899 - and up</i>				
REF 143TA8739 (∅ flange = 150,00 mm) (∅ body = 95,00 mm)		REF 143TA9177		
<i>S/N: 12141 - and up</i>				
REF 143TA8739 (∅ flange = 150,00 mm) (∅ body = 95,00 mm)			REF 143TA9465 (front, with bracket assembly) (∅ = 338,00 mm)	
<i>S/N: 13055 - and up</i>				
REF 143TA8739 (∅ flange = 150,00 mm) (∅ body = 95,00 mm)				REF 143TA9873 (rubber) (400 x 72,5 x 70) (with rail)
KOMATSU PC40-7				
<i>S/N: 18001 - 24521</i>				
REF 143TA8739 (∅ flange = 150,00 mm) (∅ body = 95,00 mm)	REF 143TA8947 (assembly) (∅ flange = 142,00 mm) (∅ body = 82,50 mm)	REF 143TA9185	REF 143TA9468 (front, with bracket assembly) (∅ = 371,00 mm)	REF 143TA9875 (rubber) (400 x 72,5 x 72) (with rail)
<i>S/N: 24522 - 25568</i>				
				REF 143TA9876 (rubber) (400 x 72,5 x 72)







used for KOMATSU				
TRACK ROLLER	TOP ROLLER	SPROCKET	IDLER	TRACK
				
<i>S/N: 24522 - and up</i>				
REF 143TA8743 (∅ flange = 115,00 mm) (∅ body = 95,00 mm)	REF 143TA8938 (assembly) (∅ flange = 82,00 mm) (∅ body = 35,00 mm)	REF 143TA9181	REF 143TA9469 (front, with bracket assembly) (∅ = 371,00 mm)	
<i>S/N: 25669 - and up</i>				
				REF 143TA9877 (rubber) (400 x 72,5 x 72)
KOMATSU PC40FR-1				
REF 164TA2109		REF 143TA9182	REF 144TA4502 (front, with bracket assembly)	REF 164TA2040 (rubber) (400 x 107 x 46)
KOMATSU PC40FR-2				
<i>S/N: 18001 - 24521</i>				
REF 164TA2110	REF 164TA2121 (assembly)	REF 144TA4509 (number of teeth = 19) (number of holes = 9)	REF 164TA2146 (front, with bracket assembly)	
<i>S/N: 25669 - and up</i>				
				REF 164TA2041 (rubber) (350 x 75,5 x 74) (offset)
KOMATSU PC40MR-1				
<i>S/N: 01001 - 01882</i>				
REF 143TA8747 (∅ flange = 170,00 mm) (∅ body = 95,00 mm)	REF 143TA8952 (assembly) (∅ body = 70,30 mm)	REF 143TA9184 (number of teeth = 19) (number of holes = 12)	REF 143TA9472 (front, with bracket assembly) (∅ = 356,00 mm)	REF 143TA9877 (rubber) (400 x 72,5 x 72)
<i>S/N: 01883 - 02290</i>				
REF 143TA8748 (∅ flange = 170,00 mm) (∅ body = 95,00 mm)	REF 143TA8952 (assembly) (∅ body = 70,30 mm)	REF 143TA9184 (number of teeth = 19) (number of holes = 12)	REF 143TA9472 (front, with bracket assembly) (∅ = 356,00 mm)	REF 143TA9877 (rubber) (400 x 72,5 x 72)
<i>S/N: 02291 - and up</i>				
REF 143TA8749 (∅ flange = 170,00 mm) (∅ body = 95,00 mm)	REF 143TA8952 (assembly) (∅ body = 70,30 mm)	REF 143TA9184 (number of teeth = 19) (number of holes = 12)	REF 143TA9472 (front, with bracket assembly) (∅ = 356,00 mm)	REF 143TA9877 (rubber) (400 x 72,5 x 72)
KOMATSU PC40MR-2				
REF 143TA8749 (∅ flange = 170,00 mm) (∅ body = 95,00 mm)	REF 143TA8956 (assembly) (∅ body = 70,30 mm)	REF 143TA9184 (number of teeth = 19) (number of holes = 12)	REF 143TA9472 (front, with bracket assembly) (∅ = 356,00 mm)	REF 143TA9880 (rubber) (400 x 72,5 x 74)
KOMATSU PC40MR-2-AC				
REF 143TA8749 (∅ flange = 170,00 mm) (∅ body = 95,00 mm)	REF 143TA8956 (assembly) (∅ body = 70,30 mm)	REF 143TA9184 (number of teeth = 19) (number of holes = 12)	REF 143TA9472 (front, with bracket assembly) (∅ = 356,00 mm)	REF 143TA9880 (rubber) (400 x 72,5 x 74)
KOMATSU PC40MRX-1				
<i>S/N: 01001 - 01882</i>				
REF 143TA8747 (for Europe and North America) (∅ flange = 170,00 mm) (∅ body = 95,00 mm)	REF 143TA8952 (assembly) (for Europe and North America) (∅ body = 70,30 mm)	REF 143TA9184 (for Europe and North America) (number of teeth = 19) (number of holes = 12)	REF 143TA9472 (front, with bracket assembly) (for Europe and North America) (∅ = 356,00 mm)	REF 143TA9877 (rubber) (400 x 72,5 x 72) (for Europe and North America)
<i>S/N: 01883 - 02290</i>				
REF 143TA8748 (for Europe and North America) (∅ flange = 170,00 mm) (∅ body = 95,00 mm)	REF 143TA8952 (assembly) (for Europe and North America) (∅ body = 70,30 mm)	REF 143TA9184 (for Europe and North America) (number of teeth = 19) (number of holes = 12)	REF 143TA9472 (front, with bracket assembly) (for Europe and North America) (∅ = 356,00 mm)	REF 143TA9877 (rubber) (400 x 72,5 x 72) (for Europe and North America)



TRACKS & UNDERCARRIAGE PARTS



used for KOMATSU

used for KOMATSU				
TRACK ROLLER	TOP ROLLER	SPROCKET	IDLER	TRACK
				
<i>S/N: 02291 - and up</i>				
REF 143TA8749 (for Europe and North America) (Ø flange = 170,00 mm) (Ø body = 95,00 mm)	REF 143TA8952 (assembly) (for Europe and North America) (Ø body = 70,30 mm)	REF 143TA9184 (for Europe and North America) (number of teeth = 19) (number of holes = 12)	REF 143TA9472 (front, with bracket assembly) (for Europe and North America) (Ø = 356,00 mm)	REF 143TA9877 (rubber) (400 x 72,5 x 72) (for Europe and North America)
KOMATSU PC40R-7				
<i>S/N: 18001 - 23884</i>				
		REF 143TA9185	REF 143TA9473 (front, with bracket assembly) (for steel tracks) (Ø = 371,00 mm)	REF 164TA2066 (steel) (width = 400,00 mm)
<i>S/N: 18001 - 24521</i>				
REF 143TA8739 (for rubber tracks) (Ø flange = 150,00 mm) (Ø body = 95,00 mm)	REF 143TA8947 (assembly) (for rubber tracks) (Ø flange = 142,00 mm) (Ø body = 82,50 mm)	REF 143TA9185	REF 143TA9468 (front, with bracket assembly) (for rubber tracks) (Ø = 371,00 mm)	REF 143TA9875 (rubber) (400 x 72,5 x 72) (with rail)
REF 143TA8753 (for steel tracks) (Ø flange = 115,00 mm) (Ø body = 95,00 mm)	REF 143TA9474 (assembly) (for steel tracks)			REF 164TA2066 (steel) (width = 400,00 mm)
<i>S/N: 23885 - 24521</i>				
		REF 143TA9185	REF 143TA9474 (front, with bracket assembly) (for steel tracks)	REF 164TA2066 (steel) (width = 400,00 mm)
<i>S/N: 24522 - 25568</i>				
		REF 143TA9185		REF 143TA9876 (rubber) (400 x 72,5 x 72) REF 164TA2066 (steel) (width = 400,00 mm)
<i>S/N: 24522 - and up</i>				
REF 143TA8743 (for rubber and steel tracks) (Ø flange = 115,00 mm) (Ø body = 95,00 mm)	REF 143TA8938 (assembly) (for rubber and steel tracks) (Ø flange = 82,00 mm) (Ø body = 35,00 mm)	REF 143TA9185	REF 143TA9469 (front, with bracket assembly) (for rubber and steel tracks) (Ø = 371,00 mm)	REF 164TA2066 (steel) (width = 400,00 mm)
<i>S/N: 25569 - and up</i>				
		REF 143TA9185		REF 143TA9877 (rubber) (400 x 72,5 x 72) REF 164TA2066 (steel) (width = 400,00 mm)
KOMATSU PC40R-8				
<i>S/N: 30001 - 31607</i>				
REF 143TA8755 (Ø flange = 170,00 mm) (Ø body = 95,00 mm)	REF 143TA8952 (assembly) (Ø body = 70,30 mm)	REF 143TA9186 (number of teeth = 19) (number of holes = 9)	REF 143TA9472 (front, with bracket assembly) (Ø = 356,00 mm)	REF 143TA9877 (rubber) (400 x 72,5 x 72) REF 163TA9543 (steel) (width = 400,00 mm) (number of links = 38)
<i>S/N: 31608 - 31727</i>				
REF 143TA8747 (Ø flange = 170,00 mm) (Ø body = 95,00 mm)	REF 143TA8952 (assembly) (Ø body = 70,30 mm)	REF 143TA9186 (number of teeth = 19) (number of holes = 9)	REF 143TA9472 (front, with bracket assembly) (Ø = 356,00 mm)	REF 143TA9877 (rubber) (400 x 72,5 x 72) REF 163TA9543 (steel) (width = 400,00 mm) (number of links = 38)





used for KOMATSU				
TRACK ROLLER	TOP ROLLER	SPROCKET	IDLER	TRACK
				
<i>S/N: 31728 - and up</i>				
REF 143TA8748 (Ø flange = 170,00 mm) (Ø body = 95,00 mm)	REF 143TA8952 (assembly) (Ø body = 70,30 mm)	REF 143TA9186 (number of teeth = 19) (number of holes = 9)	REF 143TA9472 (front, with bracket assembly) (Ø = 356,00 mm)	REF 143TA9877 (rubber) (400 x 72,5 x 72) REF 163TA9543 (steel) (width = 400,00 mm) (number of links = 38)
KOMATSU PC40T-7				
REF 143TA8739 (Ø flange = 150,00 mm) (Ø body = 95,00 mm)	REF 143TA8947 (assembly) (Ø flange = 142,00 mm) (Ø body = 82,50 mm)	REF 143TA9177	REF 163TA9557 (front, with bracket assembly)	REF 164TA2042 (rubber) (400 x 72,5 x 72)
KOMATSU PC45-1				
<i>S/N: 01001 - 03505</i>				
REF 143TA8739 (for rubber tracks) (Ø flange = 150,00 mm) (Ø body = 95,00 mm)	REF 143TA8947 (assembly) (for rubber tracks) (Ø flange = 142,00 mm) (Ø body = 82,50 mm)	REF 143TA9179 (for rubber tracks) (number of teeth = 19) (number of holes = 9)	REF 143TA9468 (front, with bracket assembly) (for rubber tracks) (Ø = 371,00 mm)	REF 143TA9875 (rubber) (400 x 72,5 x 72) (with rail)
REF 143TA8753 (for steel tracks) (Ø flange = 115,00 mm) (Ø body = 95,00 mm)	REF 143TA8938 (assembly) (for steel tracks) (Ø flange = 82,00 mm) (Ø body = 35,00 mm)	REF 163TA9549 (for steel tracks) (number of teeth = 19) (number of holes = 9)	REF 143TA9474 (front, with bracket assembly) (for steel tracks)	REF 164TA2066 (steel) (width = 400,00 mm)
<i>S/N: 03506 - 03847</i>				
	REF 143TA8938 (assembly) (for steel tracks) (Ø flange = 82,00 mm) (Ø body = 35,00 mm)	REF 163TA9549 (for rubber and steel tracks) (number of teeth = 19) (number of holes = 9)		REF 164TA2066 (steel) (width = 400,00 mm)
<i>S/N: 03506 - 03895</i>				
	REF 143TA8938 (assembly) (for steel tracks) (Ø flange = 82,00 mm) (Ø body = 35,00 mm)			REF 143TA9876 (rubber) (400 x 72,5 x 72) REF 164TA2066 (steel) (width = 400,00 mm)
<i>S/N: 03506 - and up</i>				
REF 143TA8743 (for rubber and steel tracks) (Ø flange = 115,00 mm) (Ø body = 95,00 mm)	REF 143TA8938 (assembly) (for rubber and steel tracks) (Ø flange = 82,00 mm) (Ø body = 35,00 mm)		REF 143TA9469 (front, with bracket assembly) (for rubber and steel tracks) (Ø = 371,00 mm)	REF 164TA2066 (steel) (width = 400,00 mm)
<i>S/N: 03848 - and up</i>				
	REF 143TA8938 (assembly) (for steel tracks) (Ø flange = 82,00 mm) (Ø body = 35,00 mm)	REF 143TA9186 (for rubber tracks) (number of teeth = 19) (number of holes = 9) REF 143TA9186 (for steel tracks) (number of teeth = 19) (number of holes = 9)		REF 164TA2066 (steel) (width = 400,00 mm)
<i>S/N: 03896 - and up</i>				
	REF 143TA8938 (assembly) (for steel tracks) (Ø flange = 82,00 mm) (Ø body = 35,00 mm)			REF 143TA9877 (rubber) (400 x 72,5 x 72)



used for KOMATSU				
TRACK ROLLER	TOP ROLLER	SPROCKET	IDLER	TRACK
				
				REF 164TA2066 (steel) (width = 400,00 mm)
KOMATSU PC45MR-1				
<i>S/N: 01001 - 03394</i>				
REF 143TA8747 (Ø flange = 170,00 mm) (Ø body = 95,00 mm)	REF 143TA8952 (assembly) (Ø body = 70,30 mm)	REF 143TA9184 (number of teeth = 19) (number of holes = 12)	REF 143TA9472 (front, with bracket assembly) (Ø = 356,00 mm)	REF 143TA9877 (rubber) (400 x 72,5 x 72)
<i>S/N: 03395 - 04540</i>				
REF 143TA8748 (Ø flange = 170,00 mm) (Ø body = 95,00 mm)	REF 143TA8952 (assembly) (Ø body = 70,30 mm)	REF 143TA9184 (number of teeth = 19) (number of holes = 12)	REF 143TA9472 (front, with bracket assembly) (Ø = 356,00 mm)	REF 143TA9877 (rubber) (400 x 72,5 x 72)
<i>S/N: 04541 - and up</i>				
REF 143TA8749 (Ø flange = 170,00 mm) (Ø body = 95,00 mm)	REF 143TA8952 (assembly) (Ø body = 70,30 mm)	REF 143TA9184 (number of teeth = 19) (number of holes = 12)	REF 143TA9472 (front, with bracket assembly) (Ø = 356,00 mm)	REF 143TA9877 (rubber) (400 x 72,5 x 72)
KOMATSU PC45MR-3				
<i>S/N: F30003 - and up</i>				
REF 143TA8754 (Ø flange = 170,00 mm) (Ø body = 95,00 mm)	REF 143TA8956 (assembly) (Ø body = 70,30 mm)	REF 143TA9189 (number of teeth = 19) (number of holes = 12)	REF 143TA9477 (front, with bracket assembly) (Ø = 356,00 mm)	REF 143TA9883 (rubber) (400 x 72,5 x 72)
KOMATSU PC45MRX-1				
<i>S/N: 01001 - 03394</i>				
REF 143TA8747 (for Europe and North America) (Ø flange = 170,00 mm) (Ø body = 95,00 mm)	REF 143TA8952 (assembly) (for Europe and North America) (Ø body = 70,30 mm)	REF 143TA9184 (for Europe and North America) (number of teeth = 19) (number of holes = 12)	REF 143TA9472 (front, with bracket assembly) (for Europe and North America) (Ø = 356,00 mm)	REF 143TA9877 (rubber) (400 x 72,5 x 72) (for Europe and North America)
<i>S/N: 03395 - 04540</i>				
REF 143TA8748 (for Europe and North America) (Ø flange = 170,00 mm) (Ø body = 95,00 mm)	REF 143TA8952 (assembly) (for Europe and North America) (Ø body = 70,30 mm)	REF 143TA9184 (for Europe and North America) (number of teeth = 19) (number of holes = 12)	REF 143TA9472 (front, with bracket assembly) (for Europe and North America) (Ø = 356,00 mm)	REF 143TA9877 (rubber) (400 x 72,5 x 72) (for Europe and North America)
<i>S/N: 04541 - and up</i>				
REF 143TA8749 (for Europe and North America) (Ø flange = 170,00 mm) (Ø body = 95,00 mm)	REF 143TA8952 (assembly) (for Europe and North America) (Ø body = 70,30 mm)	REF 143TA9184 (for Europe and North America) (number of teeth = 19) (number of holes = 12)	REF 143TA9472 (front, with bracket assembly) (for Europe and North America) (Ø = 356,00 mm)	REF 143TA9877 (rubber) (400 x 72,5 x 72) (for Europe and North America)
KOMATSU PC45R-8				
<i>S/N: 05001 - 05751</i>				
REF 143TA8755 (Ø flange = 170,00 mm) (Ø body = 95,00 mm)	REF 143TA8952 (assembly) (Ø body = 70,30 mm)		REF 143TA9472 (front, with bracket assembly) (Ø = 356,00 mm)	REF 143TA9877 (rubber) (400 x 72,5 x 72) REF 163TA9544 (steel) (width = 400,00 mm)
<i>S/N: 05001 - 05981</i>				
	REF 143TA8952 (assembly) (Ø body = 70,30 mm)	REF 143TA9186 (number of teeth = 19) (number of holes = 9)	REF 143TA9472 (front, with bracket assembly) (Ø = 356,00 mm)	REF 143TA9877 (rubber) (400 x 72,5 x 72) REF 163TA9544 (steel) (width = 400,00 mm)
<i>S/N: 05752 - 06132</i>				
REF 143TA8747 (Ø flange = 170,00 mm) (Ø body = 95,00 mm)	REF 143TA8952 (assembly) (Ø body = 70,30 mm)		REF 143TA9472 (front, with bracket assembly) (Ø = 356,00 mm)	REF 143TA9877 (rubber) (400 x 72,5 x 72)



used for KOMATSU				
TRACK ROLLER	TOP ROLLER	SPROCKET	IDLER	TRACK
				
				REF 163TA9544 (steel) (width = 400,00 mm)
<i>S/N: 05982 - and up</i>				
	REF 143TA8952 (assembly) (Ø body = 70,30 mm)	REF 163TA9549 (number of teeth = 19) (number of holes = 9)	REF 143TA9472 (front, with bracket assembly) (Ø = 356,00 mm)	REF 143TA9877 (rubber) (400 x 72,5 x 72) REF 163TA9544 (steel) (width = 400,00 mm)
<i>S/N: 06133 - and up</i>				
REF 143TA8748 (Ø flange = 170,00 mm) (Ø body = 95,00 mm)	REF 143TA8952 (assembly) (Ø body = 70,30 mm)		REF 143TA9472 (front, with bracket assembly) (Ø = 356,00 mm)	REF 143TA9877 (rubber) (400 x 72,5 x 72) REF 163TA9544 (steel) (width = 400,00 mm)
<i>S/N: F20001 - F20664</i>				
REF 143TA8756 (Ø flange = 170,00 mm) (Ø body = 95,00 mm)	REF 143TA8953 (assembly) (Ø body = 70,30 mm)	REF 143TA9188 (number of teeth = 19) (number of holes = 9)	REF 143TA9478 (front, with bracket assembly) (for rubber tracks) (Ø = 371,00 mm)	REF 143TA9882 (rubber) (400 x 72,5 x 72) REF 163TA8922 (steel)
<i>S/N: F20001 - F20677</i>				
REF 143TA8756 (Ø flange = 170,00 mm) (Ø body = 95,00 mm)	REF 143TA8953 (assembly) (Ø body = 70,30 mm)	REF 143TA9188 (number of teeth = 19) (number of holes = 9)	REF 163TA8924 (front, with bracket assembly) (for steel tracks)	REF 143TA9882 (rubber) (400 x 72,5 x 72) REF 163TA8922 (steel)
<i>S/N: F20665 - and up</i>				
REF 143TA8756 (Ø flange = 170,00 mm) (Ø body = 95,00 mm)	REF 143TA8953 (assembly) (Ø body = 70,30 mm)	REF 143TA9188 (number of teeth = 19) (number of holes = 9)	REF 143TA9479 (front, with bracket assembly) (for rubber tracks) (Ø = 371,00 mm)	REF 143TA9882 (rubber) (400 x 72,5 x 72) REF 163TA8922 (steel)
<i>S/N: F20678 - and up</i>				
REF 143TA8756 (Ø flange = 170,00 mm) (Ø body = 95,00 mm)	REF 143TA8953 (assembly) (Ø body = 70,30 mm)	REF 143TA9188 (number of teeth = 19) (number of holes = 9)	REF 164TA2144 (front, with bracket assembly) (for steel tracks)	REF 143TA9882 (rubber) (400 x 72,5 x 72) REF 163TA8922 (steel)
KOMATSU PC50FR-1				
<i>S/N: 10001 - 10105</i>				
REF 144TA4511 (Ø flange = 159,50 mm) (Ø body = 111,00 mm)	REF 143TA8939 (assembly) (Ø flange = 80,00 mm) (Ø body = 35,00 mm)	REF 144TA4509 (number of teeth = 19) (number of holes = 9)	REF 164TA2145 (front, with bracket assembly) (for steel tracks) (Ø = 375,00 mm) REF 164TA2146 (front, with bracket assembly) (for rubber tracks)	REF 144TA4382 (rubber) (400 x 144 x 36) REF 143TA9884 (steel) REF 164TA2069 (steel)





TRACKS & UNDERCARRIAGE PARTS



used for KOMATSU

used for KOMATSU				
TRACK ROLLER	TOP ROLLER	SPROCKET	IDLER	TRACK
				
<i>S/N: 10106 - and up</i>				
REF 144TA4511 (Ø flange = 159,50 mm) (Ø body = 111,00 mm)	REF 143TA8939 (assembly) (Ø flange = 80,00 mm) (Ø body = 35,00 mm)	REF 144TA4509 (number of teeth = 19) (number of holes = 9)	REF 164TA2145 (front, with bracket assembly) (for steel tracks) (Ø = 375,00 mm) REF 164TA2146 (front, with bracket assembly) (for rubber tracks)	REF 144TA4382 (rubber) (400 x 144 x 36)
KOMATSU PC50MR-2				
<i>S/N: 05001 - and up</i>				
REF 164TA2110	REF 143TA8956 (assembly) (Ø body = 70,30 mm)	REF 144TA4509 (number of teeth = 19) (number of holes = 9)	REF 164TA2146 (front, with bracket assembly)	REF 143TA9880 (rubber) (400 x 72,5 x 74)
<i>S/N: F00103 - F00751</i>				
REF 143TA8749 (Ø flange = 170,00 mm) (Ø body = 95,00 mm)	REF 143TA8956 (assembly) (Ø body = 70,30 mm)	REF 143TA9184 (number of teeth = 19) (number of holes = 12)	REF 143TA9482 (front, with bracket assembly) (Ø = 356,00 mm)	REF 143TA9883 (rubber) (400 x 72,5 x 74) REF 163TA9545 (steel)
<i>S/N: F00752 - and up</i>				
REF 143TA8754 (Ø flange = 170,00 mm) (Ø body = 95,00 mm)	REF 143TA8960 (assembly) (Ø body = 70,30 mm)	REF 143TA9189 (number of teeth = 19) (number of holes = 12)	REF 143TA9483 (front, with bracket assembly) (Ø = 356,00 mm)	REF 143TA9883 (rubber) (400 x 72,5 x 74) REF 164TA2067 (steel) REF 163TA9545 (steel) (city pad)
KOMATSU PC50MR-2-AC				
<i>S/N: 05001 - and up</i>				
REF 164TA2110	REF 143TA8956 (assembly) (Ø body = 70,30 mm)	REF 144TA4509 (number of teeth = 19) (number of holes = 9)	REF 164TA2146 (front, with bracket assembly)	REF 143TA9880 (rubber) (400 x 72,5 x 74)
<i>S/N: F00752 - and up</i>				
				REF 163TA9545 (steel) (city pad)
KOMATSU PC50UD-2				
<i>S/N: 08001 - 11334</i>				
			REF 143TA9473 (front, with bracket assembly) (for steel tracks) (Ø = 371,00 mm)	REF 163TA9544 (steel) (width = 400,00 mm) REF 164TA2068 (steel) (width = 480,00 mm)
<i>S/N: 08001 - 12759</i>				
REF 143TA8753 (for steel tracks) (Ø flange = 115,00 mm) (Ø body = 95,00 mm) REF 143TA8739 (for rubber tracks) (Ø flange = 150,00 mm) (Ø body = 95,00 mm)	REF 143TA8947 (assembly) (for rubber tracks) (Ø flange = 142,00 mm) (Ø body = 82,50 mm)	REF 163TA9549 (for steel tracks) (number of teeth = 19) (number of holes = 9) REF 143TA9179 (for rubber tracks) (number of teeth = 19) (number of holes = 9)	REF 143TA9468 (front, with bracket assembly) (for rubber tracks) (Ø = 371,00 mm)	REF 143TA9875 (rubber) (400 x 72,5 x 72) (with rail) REF 163TA9544 (steel) (width = 400,00 mm) REF 164TA2068 (steel) (width = 480,00 mm)







used for KOMATSU				
TRACK ROLLER	TOP ROLLER	SPROCKET	IDLER	TRACK
				
<i>S/N: 08001 - 12799</i>				
	REF 143TA8938 (assembly) (for steel tracks) (∅ flange = 82,00 mm) (∅ body = 35,00 mm)			REF 163TA9544 (steel) (width = 400,00 mm) REF 164TA2068 (steel) (width = 480,00 mm)
<i>S/N: 11335 - 12759</i>				
			REF 143TA9474 (front, with bracket assembly) (for steel tracks)	REF 163TA9544 (steel) (width = 400,00 mm) REF 164TA2068 (steel) (width = 480,00 mm)
<i>S/N: 12760 - 12799</i>				
REF 143TA8743 (for rubber and steel tracks) (∅ flange = 115,00 mm) (∅ body = 95,00 mm)	REF 143TA8938 (assembly) (for rubber tracks) (∅ flange = 82,00 mm) (∅ body = 35,00 mm)			REF 163TA9544 (steel) (width = 400,00 mm) REF 164TA2068 (steel) (width = 480,00 mm)
<i>S/N: 12760 - 12809</i>				
		REF 143TA9186 (for steel tracks) (number of teeth = 19) (number of holes = 9)		REF 163TA9544 (steel) (width = 400,00 mm) REF 164TA2068 (steel) (width = 480,00 mm)
<i>S/N: 12760 - and up</i>				
		REF 143TA9184 (for rubber tracks) (number of teeth = 19) (number of holes = 12)	REF 143TA9469 (front, with bracket assembly) (for rubber and steel tracks) (∅ = 371,00 mm)	REF 143TA9877 (rubber) (400 x 72,5 x 72) REF 163TA9544 (steel) (width = 400,00 mm) REF 164TA2068 (steel) (width = 480,00 mm)
<i>S/N: 12800 - and up</i>				
REF 143TA8747 (for steel tracks) (∅ flange = 170,00 mm) (∅ body = 95,00 mm) REF 143TA8747 (for rubber tracks) (∅ flange = 170,00 mm) (∅ body = 95,00 mm)	REF 143TA8952 (assembly) (for steel tracks) (∅ body = 70,30 mm) REF 143TA8952 (assembly) (for rubber tracks) (∅ body = 70,30 mm)			REF 163TA9544 (steel) (width = 400,00 mm) REF 164TA2068 (steel) (width = 480,00 mm)
<i>S/N: 12810 - and up</i>				
		REF 143TA9184 (for steel tracks) (number of teeth = 19) (number of holes = 12)		REF 163TA9544 (steel) (width = 400,00 mm) REF 164TA2068 (steel) (width = 480,00 mm)







used for KOMATSU				
TRACK ROLLER	TOP ROLLER	SPROCKET	IDLER	TRACK
				
KOMATSU PC50UU-1				
<i>S/N: 01001 - 01769</i>				
REF 143TA8739 (for rubber and steel tracks) (Ø flange = 150,00 mm) (Ø body = 95,00 mm) REF 163TA9550 (for steel tracks) (for short reach) REF 143TA8742 (for steel tracks)		REF 143TA9179 (number of teeth = 19) (number of holes = 9)		REF 163TA9548 (steel) (width = 400,00 mm) REF 164TA2070 (steel) (width = 500,00 mm) (for short reach)
<i>S/N: 01001 - 01800</i>				
REF 143TA8739 (for rubber and steel tracks) (Ø flange = 150,00 mm) (Ø body = 95,00 mm) REF 163TA9550 (for steel tracks) (for short reach) REF 143TA8742 (for steel tracks)		REF 143TA9179 (number of teeth = 19) (number of holes = 9)	REF 143TA9442 (front, with bracket assembly)	REF 164TA2070 (steel) (width = 500,00 mm) (for short reach)
<i>S/N: 01001 - 02026</i>				
REF 143TA8739 (for rubber and steel tracks) (Ø flange = 150,00 mm) (Ø body = 95,00 mm) REF 163TA9550 (for steel tracks) (for short reach) REF 143TA8742 (for steel tracks)		REF 143TA9179 (number of teeth = 19) (number of holes = 9)		REF 143TA9887 (rubber) (400 x 72,5 x 70) (with rail) REF 164TA2070 (steel) (width = 500,00 mm) (for short reach)
<i>S/N: 01770 - 02141</i>				
REF 143TA8739 (for rubber and steel tracks) (Ø flange = 150,00 mm) (Ø body = 95,00 mm) REF 163TA9550 (for steel tracks) (for short reach) REF 143TA8742 (for steel tracks)		REF 143TA9179 (number of teeth = 19) (number of holes = 9)		REF 163TA9547 (steel) (width = 400,00 mm) REF 164TA2070 (steel) (width = 500,00 mm) (for short reach)
<i>S/N: 01801 - 03400</i>				
REF 143TA8739 (for rubber and steel tracks) (Ø flange = 150,00 mm) (Ø body = 95,00 mm) REF 163TA9550 (for steel tracks) (for short reach) REF 143TA8742 (for steel tracks)		REF 143TA9179 (number of teeth = 19) (number of holes = 9)	REF 143TA9464 (front, with bracket assembly)	REF 164TA2070 (steel) (width = 500,00 mm) (for short reach)
<i>S/N: 02027 - 03713</i>				
REF 143TA8739 (for rubber and steel tracks) (Ø flange = 150,00 mm) (Ø body = 95,00 mm) REF 163TA9550 (for steel tracks) (for short reach) REF 143TA8742 (for steel tracks)		REF 143TA9179 (number of teeth = 19) (number of holes = 9)		REF 143TA9872 (rubber) (400 x 72,5 x 70) REF 164TA2070 (steel) (width = 500,00 mm) (for short reach)







used for KOMATSU				
TRACK ROLLER	TOP ROLLER	SPROCKET	IDLER	TRACK
				
<i>S/N: 02142 - and up</i>				
<p>REF 143TA8739 (for rubber and steel tracks) (∅ flange = 150,00 mm) (∅ body = 95,00 mm)</p> <p>REF 163TA9550 (for steel tracks) (for short reach)</p> <p>REF 143TA8742 (for steel tracks)</p>		<p>REF 143TA9179 (number of teeth = 19) (number of holes = 9)</p>		<p>REF 163TA9546 (steel) (width = 400,00 mm)</p> <p>REF 163TA9546 (steel) (width = 400,00 mm)</p> <p>REF 164TA2070 (steel) (width = 500,00 mm) (for short reach)</p>
<i>S/N: 03401 - and up</i>				
<p>REF 143TA8739 (for rubber and steel tracks) (∅ flange = 150,00 mm) (∅ body = 95,00 mm)</p> <p>REF 163TA9550 (for steel tracks) (for short reach)</p> <p>REF 143TA8742 (for steel tracks)</p>		<p>REF 143TA9179 (number of teeth = 19) (number of holes = 9)</p>	<p>REF 143TA9465 (front, with bracket assembly) (∅ = 338,00 mm)</p>	<p>REF 164TA2070 (steel) (width = 500,00 mm) (for short reach)</p>
<i>S/N: 03714 - and up</i>				
<p>REF 143TA8739 (for rubber and steel tracks) (∅ flange = 150,00 mm) (∅ body = 95,00 mm)</p> <p>REF 163TA9550 (for steel tracks) (for short reach)</p> <p>REF 143TA8742 (for steel tracks)</p>		<p>REF 143TA9179 (number of teeth = 19) (number of holes = 9)</p>		<p>REF 143TA9873 (rubber) (400 x 72,5 x 70) (with rail)</p> <p>REF 164TA2070 (steel) (width = 500,00 mm) (for short reach)</p>
KOMATSU PC50UU-2				
<i>S/N: 08001 - 11334</i>				
			<p>REF 143TA9473 (front, with bracket assembly) (for steel tracks) (∅ = 371,00 mm)</p>	<p>REF 163TA9544 (steel) (width = 400,00 mm)</p>
<i>S/N: 08001 - 12771</i>				
<p>REF 143TA8739 (for rubber tracks) (∅ flange = 150,00 mm) (∅ body = 95,00 mm)</p> <p>REF 143TA8753 (for steel tracks) (∅ flange = 115,00 mm) (∅ body = 95,00 mm)</p>		<p>REF 163TA9549 (for steel tracks) (number of teeth = 19) (number of holes = 9)</p> <p>REF 143TA9179 (for rubber tracks) (number of teeth = 19) (number of holes = 9)</p>	<p>REF 143TA9468 (front, with bracket assembly) (for rubber tracks) (∅ = 371,00 mm)</p>	<p>REF 143TA9875 (rubber) (400 x 72,5 x 70) (with rail)</p> <p>REF 163TA9544 (steel) (width = 400,00 mm)</p>
<i>S/N: 08001 - 14992</i>				
	<p>REF 143TA8947 (assembly) (for rubber tracks) (∅ flange = 142,00 mm) (∅ body = 82,50 mm)</p> <p>REF 143TA8938 (assembly) (for steel tracks) (∅ flange = 82,00 mm) (∅ body = 35,00 mm)</p>			<p>REF 163TA9544 (steel) (width = 400,00 mm)</p>
<i>S/N: 11335 - 12771</i>				
			<p>REF 143TA9474 (front, with bracket assembly) (for steel tracks)</p>	<p>REF 163TA9544 (steel) (width = 400,00 mm)</p>



used for KOMATSU				
TRACK ROLLER	TOP ROLLER	SPROCKET	IDLER	TRACK
				
<i>S/N: 12772 - 14992</i>				
REF 143TA8743 (for rubber and steel tracks) (Ø flange = 115,00 mm) (Ø body = 95,00 mm)				REF 163TA9544 (steel) (width = 400,00 mm)
<i>S/N: 12772 - 16960</i>				
		REF 143TA9186 (for rubber and steel tracks) (number of teeth = 19) (number of holes = 9)		REF 163TA9544 (steel) (width = 400,00 mm)
<i>S/N: 12772 - and up</i>				
			REF 143TA9469 (front, with bracket assembly) (for rubber and steel tracks) (Ø = 371,00 mm)	REF 143TA9877 (rubber) (400 x 72,5 x 72) REF 163TA9544 (steel) (width = 400,00 mm)
<i>S/N: 14993 - 16777</i>				
REF 143TA8755 (for rubber and steel tracks) (Ø flange = 170,00 mm) (Ø body = 95,00 mm)				REF 163TA9544 (steel) (width = 400,00 mm)
<i>S/N: 14993 - and up</i>				
	REF 143TA8952 (assembly) (for rubber and steel tracks) (Ø body = 70,30 mm)			REF 163TA9544 (steel) (width = 400,00 mm)
<i>S/N: 16778 - and up</i>				
REF 143TA8747 (for rubber and steel tracks) (Ø flange = 170,00 mm) (Ø body = 95,00 mm)				REF 163TA9544 (steel) (width = 400,00 mm)
<i>S/N: 16961 - and up</i>				
		REF 143TA9184 (for rubber and steel tracks) (number of teeth = 19) (number of holes = 12)		REF 163TA9544 (steel) (width = 400,00 mm)
KOMATSU PC50UUM-2				
<i>S/N: 01001 - 01419</i>				
REF 143TA8747 (Ø flange = 170,00 mm) (Ø body = 95,00 mm)	REF 143TA8952 (assembly) (Ø body = 70,30 mm)	REF 143TA9186 (number of teeth = 19) (number of holes = 9)	REF 143TA9469 (front, with bracket assembly) (Ø = 371,00 mm)	REF 143TA9877 (rubber) (400 x 72,5 x 72)
<i>S/N: 01420 - and up</i>				
REF 143TA8755 (Ø flange = 170,00 mm) (Ø body = 95,00 mm)		REF 143TA9186 (number of teeth = 19) (number of holes = 9)	REF 143TA9469 (front, with bracket assembly) (Ø = 371,00 mm)	REF 143TA9877 (rubber) (400 x 72,5 x 72)
REF 143TA8747 (Ø flange = 170,00 mm) (Ø body = 95,00 mm)				
KOMATSU PC55MR-3				
<i>S/N: 15001 - and up</i>				
REF 143TA8749 (Ø flange = 170,00 mm) (Ø body = 95,00 mm)	REF 143TA8956 (assembly) (Ø body = 70,30 mm)	REF 143TA9184 (number of teeth = 19) (number of holes = 12)	REF 143TA9477 (front, with bracket assembly) (Ø = 356,00 mm)	REF 143TA9883 (rubber) (400 x 72,5 x 74) REF 163TA9545 (steel)







used for KOMATSU				
TRACK ROLLER	TOP ROLLER	SPROCKET	IDLER	TRACK
				
<i>S/N: F30003 - and up</i>				
REF 143TA8754 (Ø flange = 170,00 mm) (Ø body = 95,00 mm)	REF 143TA8956 (assembly) (Ø body = 70,30 mm)	REF 143TA9189 (number of teeth = 19) (number of holes = 12)	REF 143TA9477 (front, with bracket assembly) (Ø = 356,00 mm)	REF 143TA9883 (rubber) (400 x 72,5 x 74) REF 163TA9545 (steel)
KOMATSU PC58SF-1				
<i>S/N: 01001 - 01018</i>				
REF 143TA8758	REF 143TA8952 (assembly) (Ø body = 70,30 mm)	REF 143TA9186 (number of teeth = 19) (number of holes = 9)	REF 143TA9469 (front, with bracket assembly) (Ø = 371,00 mm)	REF 143TA9877 (rubber) (400 x 72,5 x 74)
<i>S/N: 01019 - 01393</i>				
REF 143TA8747 (Ø flange = 170,00 mm) (Ø body = 95,00 mm)	REF 143TA8952 (assembly) (Ø body = 70,30 mm)	REF 143TA9184 (number of teeth = 19) (number of holes = 12)	REF 143TA9469 (front, with bracket assembly) (Ø = 371,00 mm)	REF 143TA9877 (rubber) (400 x 72,5 x 74)
<i>S/N: 01019 - and up</i>				
	REF 143TA8952 (assembly) (Ø body = 70,30 mm)	REF 143TA9184 (number of teeth = 19) (number of holes = 12)	REF 143TA9469 (front, with bracket assembly) (Ø = 371,00 mm)	REF 143TA9877 (rubber) (400 x 72,5 x 74)
<i>S/N: 01394 - 01411</i>				
REF 143TA8748 (Ø flange = 170,00 mm) (Ø body = 95,00 mm)	REF 143TA8952 (assembly) (Ø body = 70,30 mm)		REF 143TA9469 (front, with bracket assembly) (Ø = 371,00 mm)	REF 143TA9877 (rubber) (400 x 72,5 x 74)
<i>S/N: 01412 - and up</i>				
REF 143TA8749 (Ø flange = 170,00 mm) (Ø body = 95,00 mm)	REF 143TA8952 (assembly) (Ø body = 70,30 mm)		REF 143TA9469 (front, with bracket assembly) (Ø = 371,00 mm)	REF 143TA9877 (rubber) (400 x 72,5 x 74)
KOMATSU PC58UU-3				
<i>S/N: 20001 - 20252</i>				
REF 143TA8748 (Ø flange = 170,00 mm) (Ø body = 95,00 mm)		REF 143TA9184 (number of teeth = 19) (number of holes = 12)	REF 143TA9472 (front, with bracket assembly) (Ø = 356,00 mm)	REF 143TA9883 (rubber) (400 x 72,5 x 74)
<i>S/N: 20001 - 22300</i>				
	REF 143TA8952 (assembly) (Ø body = 70,30 mm)	REF 143TA9184 (number of teeth = 19) (number of holes = 12)	REF 143TA9472 (front, with bracket assembly) (Ø = 356,00 mm)	REF 143TA9883 (rubber) (400 x 72,5 x 74)
<i>S/N: 20253 - and up</i>				
REF 143TA8749 (Ø flange = 170,00 mm) (Ø body = 95,00 mm)		REF 143TA9184 (number of teeth = 19) (number of holes = 12)	REF 143TA9472 (front, with bracket assembly) (Ø = 356,00 mm)	REF 143TA9883 (rubber) (400 x 72,5 x 74)
<i>S/N: 22301 - and up</i>				
	REF 143TA8956 (assembly) (Ø body = 70,30 mm)	REF 143TA9184 (number of teeth = 19) (number of holes = 12)	REF 143TA9472 (front, with bracket assembly) (Ø = 356,00 mm)	REF 143TA9883 (rubber) (400 x 72,5 x 74)
KOMATSU PC60-6				
<i>S/N: 28001 - 31642</i>				
REF 143TA8762	REF 143TA8963 (assembly) (Ø flange = 182,00 mm) (Ø body = 120,00 mm)	REF 143TA9192 (number of teeth = 21) (number of holes = 12)	REF 143TA9486 (front, with bracket assembly) (Ø = 458,00 mm)	



used for KOMATSU				
TRACK ROLLER	TOP ROLLER	SPROCKET	IDLER	TRACK
S/N: 28001 - 39981				
				
REF 143TA8762	REF 143TA8963 (assembly) (Ø flange = 182,00 mm) (Ø body = 120,00 mm)	REF 143TA9192 (number of teeth = 21) (number of holes = 12)		REF 143TA9888 (rubber) (450 x 83,5 x 74)
S/N: 31643 - and up				
REF 143TA8762	REF 143TA8963 (assembly) (Ø flange = 182,00 mm) (Ø body = 120,00 mm)	REF 143TA9192 (number of teeth = 21) (number of holes = 12)	REF 143TA9487 (front, with bracket assembly) (Ø = 458,00 mm)	
S/N: 39982 - and up				
REF 143TA8762	REF 143TA8963 (assembly) (Ø flange = 182,00 mm) (Ø body = 120,00 mm)	REF 143TA9192 (number of teeth = 21) (number of holes = 12)		REF 143TA9889 (rubber) (450 x 83,5 x 74)
KOMATSU PC60-6S				
S/N: 28001 - 31642				
REF 143TA8762	REF 143TA8963 (assembly) (Ø flange = 182,00 mm) (Ø body = 120,00 mm)	REF 143TA9192 (number of teeth = 21) (number of holes = 12)	REF 143TA9486 (front, with bracket assembly) (Ø = 458,00 mm)	
S/N: 28001 - 39981				
REF 143TA8762	REF 143TA8963 (assembly) (Ø flange = 182,00 mm) (Ø body = 120,00 mm)	REF 143TA9192 (number of teeth = 21) (number of holes = 12)		REF 143TA9888 (rubber) (450 x 83,5 x 74)
S/N: 31643 - and up				
REF 143TA8762	REF 143TA8963 (assembly) (Ø flange = 182,00 mm) (Ø body = 120,00 mm)	REF 143TA9192 (number of teeth = 21) (number of holes = 12)	REF 143TA9487 (front, with bracket assembly) (Ø = 458,00 mm)	
S/N: 39982 - and up				
REF 143TA8762	REF 143TA8963 (assembly) (Ø flange = 182,00 mm) (Ø body = 120,00 mm)	REF 143TA9192 (number of teeth = 21) (number of holes = 12)		REF 143TA9889 (rubber) (450 x 83,5 x 74)
KOMATSU PC60-6Z				
S/N: 28001 - 39981				
REF 143TA8762	REF 143TA8963 (assembly) (Ø flange = 182,00 mm) (Ø body = 120,00 mm)	REF 143TA9192 (number of teeth = 21) (number of holes = 12)	REF 143TA9487 (front, with bracket assembly) (Ø = 458,00 mm)	REF 143TA9888 (rubber) (450 x 83,5 x 74)
S/N: 39982 - and up				
REF 143TA8762	REF 143TA8963 (assembly) (Ø flange = 182,00 mm) (Ø body = 120,00 mm)	REF 143TA9192 (number of teeth = 21) (number of holes = 12)	REF 143TA9487 (front, with bracket assembly) (Ø = 458,00 mm)	REF 143TA9889 (rubber) (450 x 83,5 x 74)
KOMATSU PC60-7				
S/N: 45001 - 52373				
REF 143TA8763 (Ø flange = 158,00 mm) (Ø body = 132,00 mm)	REF 143TA8938 (assembly) (Ø flange = 82,00 mm) (Ø body = 35,00 mm)			REF 143TA9890 (rubber) (450 x 83,5 x 74)



used for KOMATSU				
TRACK ROLLER	TOP ROLLER	SPROCKET	IDLER	TRACK
				
S/N: 45001 - 54776			REF 143TA9396 (front, with bracket assembly) (Ø = 458,00 mm)	
S/N: 45001 - 54830			REF 143TA9192 (number of teeth = 21) (number of holes = 12)	
S/N: 52374 - 54337 REF 143TA8764 (Ø flange = 149,00 mm) (Ø body = 125,00 mm)	REF 143TA8939 (assembly) (Ø flange = 80,00 mm) (Ø body = 35,00 mm)			REF 143TA9891 (rubber) (450 x 83,5 x 72)
S/N: 54338 - 58396	REF 143TA8938 (assembly) (Ø flange = 82,00 mm) (Ø body = 35,00 mm)			REF 143TA9891 (rubber) (450 x 83,5 x 72)
S/N: 54338 - 59545 REF 143TA8765 (Ø flange = 149,00 mm) (Ø body = 125,00 mm)				REF 143TA9891 (rubber) (450 x 83,5 x 72)
S/N: 54777 - and up			REF 143TA9397 (front, with bracket assembly) (Ø = 458,00 mm)	REF 143TA9891 (rubber) (450 x 83,5 x 72)
S/N: 54831 - and up		REF 143TA9193 (number of teeth = 21) (number of holes = 12)		REF 143TA9891 (rubber) (450 x 83,5 x 72)
S/N: 58397 - and up	REF 143TA8964 (assembly) (Ø body = 82,00 mm)			REF 143TA9891 (rubber) (450 x 83,5 x 72)
S/N: 59546 - and up REF 143TA8766 (Ø flange = 149,00 mm) (Ø body = 125,00 mm)				REF 143TA9891 (rubber) (450 x 83,5 x 72)
KOMATSU PC60-7B				
S/N: 45001 - 52373 REF 143TA8763 (Ø flange = 158,00 mm) (Ø body = 132,00 mm)	REF 143TA8938 (assembly) (Ø flange = 82,00 mm) (Ø body = 35,00 mm)			REF 143TA9890 (rubber) (450 x 83,5 x 72)
S/N: 45001 - 54776			REF 143TA9396 (front, with bracket assembly) (Ø = 458,00 mm)	
S/N: 45001 - 54830		REF 143TA9192 (number of teeth = 21) (number of holes = 12)		







used for KOMATSU				
TRACK ROLLER	TOP ROLLER	SPROCKET	IDLER	TRACK
				
<i>S/N: 52374 - 54337</i>				
REF 143TA8764 (∅ flange = 149,00 mm) (∅ body = 125,00 mm)	REF 143TA8939 (assembly) (∅ flange = 80,00 mm) (∅ body = 35,00 mm)			REF 143TA9891 (rubber) (450 x 83,5 x 72)
<i>S/N: 54338 - 58396</i>				
	REF 143TA8938 (assembly) (∅ flange = 82,00 mm) (∅ body = 35,00 mm)			REF 143TA9891 (rubber) (450 x 83,5 x 72)
<i>S/N: 54338 - 59545</i>				
REF 143TA8765 (∅ flange = 149,00 mm) (∅ body = 125,00 mm)				REF 143TA9891 (rubber) (450 x 83,5 x 72)
<i>S/N: 54777 - and up</i>				
			REF 143TA9397 (front, with bracket assembly) (∅ = 458,00 mm)	REF 143TA9891 (rubber) (450 x 83,5 x 72)
<i>S/N: 54831 - and up</i>				
		REF 143TA9193 (number of teeth = 21) (number of holes = 12)		REF 143TA9891 (rubber) (450 x 83,5 x 72)
<i>S/N: 58397 - and up</i>				
	REF 143TA8964 (assembly) (∅ body = 82,00 mm)			REF 143TA9891 (rubber) (450 x 83,5 x 72)
<i>S/N: 59546 - and up</i>				
REF 143TA8766 (∅ flange = 149,00 mm) (∅ body = 125,00 mm)				REF 143TA9891 (rubber) (450 x 83,5 x 72)
KOMATSU PC70-7				
<i>S/N: up to - 52373</i>				
REF 143TA8763 (∅ flange = 158,00 mm) (∅ body = 132,00 mm)				
<i>S/N: up to - 54776</i>				
			REF 143TA9396 (front, with bracket assembly) (∅ = 458,00 mm)	
<i>S/N: 45001 - 52373</i>				
	REF 143TA8938 (assembly) (∅ flange = 82,00 mm) (∅ body = 35,00 mm)			REF 143TA9890 (rubber) (450 x 83,5 x 72)
<i>S/N: 45001 - 54830</i>				
		REF 143TA9192 (number of teeth = 21) (number of holes = 12)		
<i>S/N: 52374 - 54337</i>				
REF 143TA8764 (∅ flange = 149,00 mm) (∅ body = 125,00 mm)	REF 143TA8939 (assembly) (∅ flange = 80,00 mm) (∅ body = 35,00 mm)			
<i>S/N: 52374 - and up</i>				
				REF 143TA9891 (rubber) (450 x 83,5 x 72)

TRACKS & UNDERCARRIAGE PARTS



used for KOMATSU

used for KOMATSU				
TRACK ROLLER	TOP ROLLER	SPROCKET	IDLER	TRACK
				
S/N: 54338 - 58396				
	REF 143TA8938 (assembly) (Ø flange = 82,00 mm) (Ø body = 35,00 mm)			
S/N: 54338 - and up				
REF 143TA8765 (Ø flange = 149,00 mm) (Ø body = 125,00 mm)				
S/N: 54777 - and up				
			REF 143TA9397 (front, with bracket assembly) (Ø = 458,00 mm)	
S/N: 54831 - and up				
		REF 143TA9193 (number of teeth = 21) (number of holes = 12)		
S/N: 58397 - and up				
	REF 143TA8964 (assembly) (Ø body = 82,00 mm)			
KOMATSU PC75-1				
S/N: 5000000 - 5000042				
	REF 143TA8968 (assembly)	REF 143TA9197 (number of teeth = 21) (number of holes = 12)		REF 143TA9894 (rubber) (450 x 76 x 80)
S/N: 5000001 - 5000042				
REF 143TA8771		REF 143TA9197 (number of teeth = 21) (number of holes = 12)	REF 143TA9491 (front, with bracket assembly)	REF 143TA9894 (rubber) (450 x 76 x 80)
S/N: 5000043 - 5000047				
REF 143TA8772		REF 143TA9197 (number of teeth = 21) (number of holes = 12)		REF 143TA9894 (rubber) (450 x 76 x 80)
S/N: 5000043 - 5000049				
	REF 143TA8969 (assembly)	REF 143TA9197 (number of teeth = 21) (number of holes = 12)	REF 143TA9492 (front, with bracket assembly) (Ø = 408,00 mm)	REF 143TA9894 (rubber) (450 x 76 x 80)
S/N: 5000048 - 5000049				
REF 143TA8773		REF 143TA9197 (number of teeth = 21) (number of holes = 12)		REF 143TA9894 (rubber) (450 x 76 x 80)
KOMATSU PC75R-2				
REF 143TA8773	REF 143TA8969 (assembly)	REF 143TA9198 (number of teeth = 21) (number of holes = 17)	REF 143TA9492 (front, with bracket assembly) (Ø = 408,00 mm)	REF 143TA9894 (rubber) (450 x 76 x 80)
KOMATSU PC75R-2HD				
S/N: 22E5210500 - 22E5210936				
REF 143TA8774 (Ø flange = 155,00 mm) (Ø body = 121,00 mm)	REF 143TA8969 (assembly)	REF 143TA9198 (number of teeth = 21) (number of holes = 17)	REF 143TA9492 (front, with bracket assembly) (Ø = 408,00 mm) REF 143TA9397 (front, with bracket assembly) (Ø = 458,00 mm)	REF 143TA9894 (rubber) (450 x 76 x 80)



used for KOMATSU				
TRACK ROLLER	TOP ROLLER	SPROCKET	IDLER	TRACK
<i>S/N: 22E5210937 - and up</i>				
REF 143TA9494 (Ø flange = 150,00 mm) (Ø body = 94,00 mm)	REF 143TA8969 (assembly)	REF 143TA9198 (number of teeth = 21) (number of holes = 17)	REF 143TA9492 (front, with bracket assembly) (Ø = 408,00 mm) REF 143TA9397 (front, with bracket assembly) (Ø = 458,00 mm)	REF 143TA9894 (rubber) (450 x 76 x 80)
KOMATSU PC75UD-2				
<i>S/N: 05001 - 07927</i>				
REF 143TA8775	REF 143TA8971 (assembly)			REF 143TA9889 (rubber) (450 x 83,5 x 74)
<i>S/N: 05001 - 10370</i>				
		REF 143TA9192 (number of teeth = 21) (number of holes = 12)	REF 143TA9487 (front, with bracket assembly) (Ø = 458,00 mm)	
<i>S/N: 07928 - 10370</i>				
REF 143TA8776 (Ø flange = 158,00 mm) (Ø body = 132,00 mm)	REF 143TA8972 (assembly) (Ø body = 82,00 mm)			
<i>S/N: 07928 - and up</i>				
				REF 143TA9896 (rubber) (450 x 83,5 x 74)
<i>S/N: 10371 - and up</i>				
REF 143TA8763 (Ø flange = 158,00 mm) (Ø body = 132,00 mm)	REF 143TA8938 (assembly) (Ø flange = 82,00 mm) (Ø body = 35,00 mm)	REF 143TA9193 (number of teeth = 21) (number of holes = 12)	REF 143TA9495 (front, with bracket assembly) (Ø = 458,00 mm)	
KOMATSU PC75UU-1				
<i>S/N: 01001 - 01174</i>				
REF 143TA8777 (Ø flange = 158,00 mm) (Ø body = 132,00 mm)	REF 143TA8973 (assembly)	REF 143TA9192 (number of teeth = 21) (number of holes = 12)	REF 143TA9496 (front, with bracket assembly)	REF 143TA9889 (rubber) (450 x 83,5 x 74)
<i>S/N: 01175 - 02010</i>				
		REF 143TA9192 (number of teeth = 21) (number of holes = 12)	REF 143TA9486 (front, with bracket assembly) (Ø = 458,00 mm)	REF 143TA9889 (rubber) (450 x 83,5 x 74)
<i>S/N: 01175 - and up</i>				
REF 143TA8762	REF 143TA8965 (assembly) (Ø body = 116,00 mm)	REF 143TA9192 (number of teeth = 21) (number of holes = 12)		REF 143TA9889 (rubber) (450 x 83,5 x 74)
<i>S/N: 02011 - and up</i>				
		REF 143TA9192 (number of teeth = 21) (number of holes = 12)	REF 143TA9487 (front, with bracket assembly) (Ø = 458,00 mm)	REF 143TA9889 (rubber) (450 x 83,5 x 74)
KOMATSU PC75UU-2				
<i>S/N: 05001 - 07927</i>				
REF 143TA8775	REF 143TA8971 (assembly)			REF 143TA9896 (rubber) (450 x 83,5 x 74)
<i>S/N: 05001 - 10370</i>				
		REF 143TA9192 (number of teeth = 21) (number of holes = 12)	REF 143TA9487 (front, with bracket assembly) (Ø = 458,00 mm)	



used for KOMATSU				
TRACK ROLLER	TOP ROLLER	SPROCKET	IDLER	TRACK
				
<i>S/N: 07928 - 10370</i>				
REF 143TA8776 (∅ flange = 158,00 mm) (∅ body = 132,00 mm)	REF 143TA8972 (assembly) (∅ body = 82,00 mm)			
<i>S/N: 07928 - and up</i>				
				REF 143TA9889 (rubber) (450 x 83,5 x 74)
<i>S/N: 10371 - and up</i>				
REF 143TA8763 (∅ flange = 158,00 mm) (∅ body = 132,00 mm)	REF 143TA8938 (assembly) (∅ flange = 82,00 mm) (∅ body = 35,00 mm)	REF 143TA9193 (number of teeth = 21) (number of holes = 12)	REF 143TA9495 (front, with bracket assembly) (∅ = 458,00 mm)	
KOMATSU PC78MR-6				
<i>S/N: 01001 - 01173</i>				
REF 143TA8778 (∅ flange = 149,00 mm) (∅ body = 125,00 mm)	REF 143TA8964 (assembly) (∅ body = 82,00 mm)	REF 143TA9201	REF 143TA9397 (front, with bracket assembly) (∅ = 458,00 mm)	REF 143TA9897 (rubber) (450 x 83,5 x 74)
<i>S/N: 01174 - 04039</i>				
REF 143TA8779 (∅ flange = 149,00 mm) (∅ body = 125,00 mm)	REF 143TA8964 (assembly) (∅ body = 82,00 mm)	REF 143TA9201	REF 143TA9397 (front, with bracket assembly) (∅ = 458,00 mm)	REF 143TA9897 (rubber) (450 x 83,5 x 74)
<i>S/N: 04040 - 04130</i>				
REF 143TA8780 (∅ flange = 149,00 mm) (∅ body = 125,00 mm)	REF 143TA8964 (assembly) (∅ body = 82,00 mm)	REF 143TA9201	REF 143TA9397 (front, with bracket assembly) (∅ = 458,00 mm)	REF 143TA9897 (rubber) (450 x 83,5 x 74)
<i>S/N: 04131 - and up</i>				
REF 143TA8781 (∅ flange = 149,00 mm) (∅ body = 125,00 mm)	REF 143TA8964 (assembly) (∅ body = 82,00 mm)	REF 143TA9201	REF 143TA9397 (front, with bracket assembly) (∅ = 458,00 mm)	REF 143TA9897 (rubber) (450 x 83,5 x 74)
KOMATSU PC78US-5				
REF 143TA8765 (∅ flange = 149,00 mm) (∅ body = 125,00 mm)	REF 143TA8938 (assembly) (∅ flange = 82,00 mm) (∅ body = 35,00 mm)	REF 143TA9200 (number of teeth = 21) (number of holes = 12)	REF 143TA9397 (front, with bracket assembly) (∅ = 458,00 mm)	REF 143TA9897 (rubber) (450 x 83,5 x 74)
KOMATSU PC78US-6				
<i>S/N: 04001 - 05936</i>				
REF 143TA8766 (∅ flange = 149,00 mm) (∅ body = 125,00 mm)	REF 143TA8964 (assembly) (∅ body = 82,00 mm)	REF 143TA9201	REF 143TA9397 (front, with bracket assembly) (∅ = 458,00 mm)	REF 143TA9897 (rubber) (450 x 83,5 x 74)
<i>S/N: 05937 - 06500</i>				
REF 143TA8778 (∅ flange = 149,00 mm) (∅ body = 125,00 mm)	REF 143TA8964 (assembly) (∅ body = 82,00 mm)	REF 143TA9201	REF 143TA9397 (front, with bracket assembly) (∅ = 458,00 mm)	REF 143TA9897 (rubber) (450 x 83,5 x 74)
<i>S/N: 06501 - and up</i>				
REF 143TA8779 (∅ flange = 149,00 mm) (∅ body = 125,00 mm)	REF 143TA8964 (assembly) (∅ body = 82,00 mm)	REF 143TA9201	REF 143TA9397 (front, with bracket assembly) (∅ = 458,00 mm)	REF 143TA9897 (rubber) (450 x 83,5 x 74)
KOMATSU PC78US-8				
<i>S/N: 15001 - 15685</i>				
REF 143TA8781 (∅ flange = 149,00 mm) (∅ body = 125,00 mm)	REF 143TA8975 (assembly) (∅ body = 80,00 mm)	REF 143TA9201	REF 143TA9397 (front, with bracket assembly) (∅ = 458,00 mm)	REF 143TA9897 (rubber) (450 x 83,5 x 74)



used for KOMATSU				
TRACK ROLLER	TOP ROLLER	SPROCKET	IDLER	TRACK
				
<i>S/N: 15686 - and up</i>				
REF 143TA8768 (∅ flange = 149,00 mm) (∅ body = 125,00 mm)	REF 143TA8975 (assembly) (∅ body = 80,00 mm)	REF 143TA9201	REF 143TA9397 (front, with bracket assembly) (∅ = 458,00 mm)	REF 143TA9897 (rubber) (450 x 83,5 x 74)
KOMATSU PC78UU-8				
<i>S/N: 15001 - 15685</i>				
REF 143TA8781 (∅ flange = 149,00 mm) (∅ body = 125,00 mm)	REF 143TA8975 (assembly) (∅ body = 80,00 mm)	REF 143TA9201	REF 143TA9397 (front, with bracket assembly) (∅ = 458,00 mm)	REF 143TA9897 (rubber) (450 x 83,5 x 74)
<i>For all other serial ranges applicable</i>				
	REF 143TA8975 (assembly) (∅ body = 80,00 mm)	REF 143TA9201	REF 143TA9397 (front, with bracket assembly) (∅ = 458,00 mm)	REF 143TA9897 (rubber) (450 x 83,5 x 74)
KOMATSU PC80MR-3				
<i>S/N: F00003 - F00255</i>				
REF 143TA8779 (∅ flange = 149,00 mm) (∅ body = 125,00 mm)	REF 143TA8964 (assembly) (∅ body = 82,00 mm)	REF 143TA9204	REF 143TA9397 (front, with bracket assembly) (∅ = 458,00 mm)	REF 164TA1541 (steel) (width = 450,00 mm) (number of links = 39) (with rubber pads)
<i>S/N: F00256 - and up</i>				
REF 143TA8781 (∅ flange = 149,00 mm) (∅ body = 125,00 mm)	REF 143TA8964 (assembly) (∅ body = 82,00 mm)	REF 143TA9204	REF 143TA9397 (front, with bracket assembly) (∅ = 458,00 mm)	REF 164TA1541 (steel) (width = 450,00 mm) (number of links = 39) (with rubber pads)







USED FOR
KUBOTA



used for KUBOTA				
TRACK ROLLER	TOP ROLLER	SPROCKET	IDLER	TRACK
				
KUBOTA K007H				
<i>S/N: up to - 12819</i>				
REF 145TA1969 (for rubber tracks)		REF 145TA1970 (for rubber tracks)	REF 145TA1971 (front, with bracket assembly) (for rubber tracks)	REF 145TA1973 (rubber) (180 x 72 x 36)
<i>S/N: 12820 - and up</i>				
			REF 145TA1972 (front, with bracket assembly) (for rubber tracks)	
KUBOTA K008				
REF 145TA1968 (Ø flange = 129,50 mm) (Ø body = 68,00 mm)		REF 144TA6593 (number of teeth = 12) (number of holes = 9)	REF 144TA6594 (front, with bracket assembly) (Ø = 248,00 mm)	REF 163TA9679 (rubber) (180 x 72 x 37)
KUBOTA K008-3				
REF 163TA9266 (Ø flange = 124,00 mm) (Ø body = 60,00 mm)		REF 163TA9250	REF 163TA9268 (front, with bracket assembly) (Ø = 248,00 mm)	REF 163TA9679 (rubber) (180 x 72 x 37)
KUBOTA K008-3ALPHA				
REF 163TA9249 (Ø flange = 126,00 mm) (Ø body = 56,00 mm)		REF 163TA9250	REF 163TA9268 (front, with bracket assembly) (Ø = 248,00 mm)	REF 163TA9680 (rubber) (180 x 72 x 37)
KUBOTA K013				
REF 144TA6612 (for rubber tracks) (Ø flange = 113,00 mm) (Ø body = 80,00 mm)				REF 143TA9899 (rubber) (230 x 96 x 30)
KUBOTA K030				
REF 144TA6692 (for rubber tracks) (Ø flange = 136,00 mm) (Ø body = 96,00 mm)				REF 163TA9698 (rubber) (300 x 52,5 x 80)
KUBOTA K035				
REF 144TA6693 (for rubber tracks) (Ø flange = 136,00 mm) (Ø body = 96,00 mm)				REF 143TA9901 (rubber) (300 x 52,5 x 84)
KUBOTA K038				
		REF 144TA6636 (for rubber tracks) (number of teeth = 23) (number of holes = 9)	REF 144TA6597 (front, with bracket assembly) (for rubber tracks) (Ø = 338,00 mm)	REF 143TA9902 (rubber) (350 x 54,5 x 86)
KUBOTA K040				
REF 144TA6609 (for rubber tracks) (Ø flange = 145,00 mm) (Ø body = 105,00 mm)	REF 144TA6641 (assembly) (for rubber tracks) (Ø body = 98,00 mm)		REF 144TA6590 (front, with bracket assembly) (for rubber tracks) (Ø = 390,00 mm)	REF 143TA9903 (rubber) (400 x 72,5 x 72)
KUBOTA K045				
REF 144TA6609 (for rubber tracks) (Ø flange = 145,00 mm) (Ø body = 105,00 mm)	REF 144TA6642 (assembly) (for rubber tracks) (Ø body = 98,00 mm)			REF 143TA9903 (rubber) (400 x 72,5 x 72)
KUBOTA KH027				
REF 144TA6678 (for rubber tracks) (Ø flange = 123,70 mm) (Ø body = 95,00 mm)				REF 143TA9904 (rubber) (300 x 109 x 37)



used for KUBOTA				
TRACK ROLLER	TOP ROLLER	SPROCKET	IDLER	TRACK
				
KUBOTA KH101				
<i>S/N: up to - 11053</i>				
REF 144TA6592 (for rubber tracks) (Ø flange = 122,00 mm) (Ø body = 98,00 mm)	REF 144TA6645 (assembly) (for rubber tracks) (Ø body = 82,50 mm)	REF 144TA6591 (for rubber tracks) (number of teeth = 23)	REF 163TA9245 (front, with bracket assembly) (for steel tracks) REF 144TA6597 (front, with bracket assembly) (for rubber tracks) (Ø = 338,00 mm)	REF 143TA9901 (rubber) (300 x 52,5 x 84)
<i>S/N: 11054 - and up</i>				
REF 144TA6592 (for rubber tracks) (Ø flange = 122,00 mm) (Ø body = 98,00 mm)	REF 144TA6645 (assembly) (for rubber tracks) (Ø body = 82,50 mm)	REF 144TA6591 (for rubber tracks) (number of teeth = 23)	REF 163TA9245 (front, with bracket assembly) (for steel tracks) REF 144TA6597 (front, with bracket assembly) (for rubber tracks) (Ø = 338,00 mm)	REF 143TA9918 (rubber) (300 x 109 x 41)
KUBOTA KH14				
REF 144TA6667 (for rubber tracks)				REF 143TA9906 (rubber) (230 x 72 x 42)
KUBOTA KH15				
REF 144TA6668 (for rubber tracks)				
KUBOTA KH151				
REF 163TA9246 (for rubber tracks) (Ø flange = 130,00 mm) (Ø body = 104,00 mm)	REF 163TA9247 (assembly) (for rubber tracks)	REF 143TA9207 (for rubber tracks) (number of teeth = 21)	REF 163TA9248 (front, with bracket assembly) (for rubber tracks)	REF 163TA9681 (rubber) (400 x 72,5 x 92)
KUBOTA KH191				
REF 144TA6665 (for rubber tracks)	REF 144TA6670 (assembly) (for rubber tracks) (Ø body = 98,20 mm)	REF 143TA9207 (for rubber tracks) (number of teeth = 21)	REF 143TA9499 (front, with bracket assembly) (for rubber tracks)	REF 143TA9907 (rubber) (450 x 71 x 78)
KUBOTA KH35				
REF 144TA6661 (for rubber tracks)		REF 144TA6584 (for rubber tracks) (number of teeth = 13)	REF 144TA6585 (front, with bracket assembly) (for rubber tracks)	REF 143TA9906 (rubber) (230 x 72 x 42)
REF 144TA6582 (for rubber tracks) (Ø flange = 116,00 mm) (Ø body = 80,00 mm)				
KUBOTA KH36				
REF 144TA6662 (for rubber tracks) (1st type)		REF 144TA6584 (for rubber tracks) (1st type) (number of teeth = 13)	REF 144TA6585 (front, with bracket assembly) (for rubber tracks) (1st type)	REF 143TA9908 (rubber) (200 x 72 x 42) (1st type)
REF 144TA6595 (for rubber and steel tracks) (2nd type) (Ø flange = 98,00 mm) (Ø body = 80,00 mm)		REF 143TA9209 (for rubber and steel tracks) (2nd type)	REF 163TA9748 (front, with bracket assembly) (for steel tracks) REF 144TA6614 (front, with bracket assembly) (for rubber and steel tracks) (2nd type) (Ø = 240,00 mm)	
KUBOTA KH41				
REF 144TA6663 (for rubber tracks) (1st type)		REF 144TA6584 (for rubber tracks) (1st type) (number of teeth = 13)	REF 144TA6585 (front, with bracket assembly) (for rubber tracks) (1st type)	REF 143TA9906 (rubber) (230 x 72 x 42)



used for KUBOTA				
TRACK ROLLER	TOP ROLLER	SPROCKET	IDLER	TRACK
				
REF 144TA6595 (for rubber and steel tracks) (2nd type) (Ø flange = 98,00 mm) (Ø body = 80,00 mm)		REF 143TA9209 (for rubber and steel tracks) (2nd type)	REF 144TA6614 (front, with bracket assembly) (for rubber and steel tracks) (2nd type) (Ø = 240,00 mm)	
KUBOTA KH41EXP				
REF 163TA9716 (for rubber tracks)		REF 164TA2083 (for rubber tracks)	REF 144TA6585 (front, with bracket assembly) (for rubber tracks)	
REF 163TA9717 (for steel tracks) (Ø flange = 98,00 mm) (Ø body = 80,00 mm)		REF 143TA9209 (for steel tracks)	REF 163TA9748 (front, with bracket assembly) (for steel tracks)	
KUBOTA KH50				
<i>S/N: up to - 10749</i>				
		REF 163TA9705 (number of teeth = 23)	REF 163TA9749 (front, with bracket assembly) (for steel tracks) REF 144TA6585 (front, with bracket assembly) (for rubber tracks)	REF 143TA9909 (rubber) (260 x 109 x 35)
<i>S/N: 10750 - and up</i>				
		REF 163TA9705 (number of teeth = 23)	REF 163TA9750 (front, with bracket assembly) (for steel tracks) REF 144TA6585 (front, with bracket assembly) (for rubber tracks)	REF 143TA9909 (rubber) (260 x 109 x 35)
KUBOTA KH50H				
<i>S/N: up to - 10749</i>				
		REF 163TA9705 (number of teeth = 23)	REF 163TA9749 (front, with bracket assembly) (for steel tracks) REF 144TA6585 (front, with bracket assembly) (for rubber tracks)	
<i>S/N: 10750 - and up</i>				
		REF 163TA9705 (number of teeth = 23)	REF 163TA9750 (front, with bracket assembly) (for steel tracks) REF 144TA6585 (front, with bracket assembly) (for rubber tracks)	
KUBOTA KH51				
REF 144TA6679 (for rubber tracks) (Ø flange = 123,70 mm) (Ø body = 95,00 mm)		REF 144TA6586 (for rubber tracks) (number of teeth = 23)	REF 163TA9751 (front, with bracket assembly) REF 163TA9752 (front, with bracket assembly) (for rubber tracks) (Ø = 338,00 mm)	REF 143TA9909 (rubber) (260 x 109 x 35)
KUBOTA KH60				
REF 144TA6680 (for rubber tracks) (Ø flange = 123,70 mm) (Ø body = 95,00 mm)	REF 144TA6646 (assembly) (for rubber tracks) (Ø body = 82,50 mm)	REF 163TA9706 (for rubber tracks)	REF 144TA6596 (front, with bracket assembly) (for rubber tracks) (Ø = 338,00 mm)	REF 143TA9904 (rubber) (300 x 109 x 37)







used for KUBOTA				
TRACK ROLLER	TOP ROLLER	SPROCKET	IDLER	TRACK
				
		REF 163TA9705 (number of teeth = 23)		
KUBOTA KH61				
REF 144TA6681 (for rubber tracks) (Ø flange = 123,70 mm) (Ø body = 95,00 mm)	REF 163TA9737 (assembly) (Ø body = 82,50 mm)	REF 144TA6586 (for rubber tracks) (number of teeth = 23)	REF 163TA9751 (front, with bracket assembly) REF 163TA9752 (front, with bracket assembly) (for rubber tracks) (Ø = 338,00 mm)	REF 143TA9910 (rubber) (300 x 109 x 35)
KUBOTA KH66				
REF 144TA6682 (for rubber tracks) (Ø flange = 123,70 mm) (Ø body = 95,00 mm)	REF 144TA6647 (assembly) (for rubber tracks) (Ø body = 82,50 mm)	REF 144TA6586 (for rubber tracks) (number of teeth = 23)	REF 163TA9751 (front, with bracket assembly) (for steel tracks) REF 163TA9753 (front, with bracket assembly) (for rubber tracks) REF 144TA6596 (front, with bracket assembly) (for rubber tracks) (Ø = 338,00 mm)	REF 143TA9910 (rubber) (300 x 109 x 35)
KUBOTA KH71				
REF 144TA6683 (for rubber tracks) (Ø flange = 123,70 mm) (Ø body = 95,00 mm)	REF 144TA6648 (assembly) (for rubber tracks) (Ø body = 82,50 mm)		REF 144TA6596 (front, with bracket assembly) (for rubber tracks) (Ø = 338,00 mm)	REF 143TA9911 (rubber) (300 x 109 x 37)
KUBOTA KH90				
REF 144TA6592 (for rubber tracks) (Ø flange = 122,00 mm) (Ø body = 98,00 mm)	REF 144TA6649 (assembly) (for rubber tracks) (Ø body = 82,50 mm)	REF 144TA6591 (for rubber tracks) (number of teeth = 23)	REF 144TA6597 (front, with bracket assembly) (for rubber tracks) (Ø = 338,00 mm)	REF 143TA9901 (rubber) (300 x 52,5 x 84)
KUBOTA KH91				
	REF 163TA9737 (assembly) (Ø body = 82,50 mm)	REF 143TA9211 (for rubber tracks)	REF 163TA9751 (front, with bracket assembly) (for steel tracks) REF 163TA9753 (front, with bracket assembly) (for rubber tracks)	REF 163TA9682 (rubber) (300 x 109 x 39)
KUBOTA KX008				
			REF 144TA6594 (front, with bracket assembly) (for rubber tracks) (Ø = 248,00 mm)	REF 163TA9679 (rubber) (180 x 72 x 37)
KUBOTA KX016-4				
REF 145TA1982 (for rubber tracks)		REF 145TA1983 (for rubber tracks) (number of teeth = 19) (number of holes = 9)	REF 145TA1984 (front, with bracket assembly) (for rubber tracks)	REF 145TA1985 (rubber) (230 x 96 x 32)
KUBOTA KX018-4				
REF 145TA1986 (for rubber tracks)		REF 145TA1983 (for rubber tracks) (number of teeth = 19) (number of holes = 9)	REF 144TA6614 (front, with bracket assembly) (for rubber tracks) (Ø = 240,00 mm)	REF 145TA1987 (rubber) (230 x 48 x 70) (with rail)



used for KUBOTA				
TRACK ROLLER	TOP ROLLER	SPROCKET	IDLER	TRACK
				
KUBOTA KX019-4				
REF 145TA1986 (for rubber tracks)		REF 145TA1983 (for rubber tracks) (number of teeth = 19) (number of holes = 9)	REF 163TA9754 (front, with bracket assembly) (for rubber tracks) REF 144TA6614 (front, with bracket assembly) (for rubber tracks) (Ø = 240,00 mm)	REF 145TA1987 (rubber) (230 x 48 x 70) (with rail)
KUBOTA KX024				
REF 144TA6684 (for rubber tracks) (Ø flange = 123,70 mm) (Ø body = 95,00 mm)	REF 144TA6650 (assembly) (for rubber tracks) (Ø body = 82,50 mm)			REF 143TA9910 (rubber) (300 x 109 x 35)
KUBOTA KX026				
REF 144TA6685 (for rubber tracks) (Ø flange = 123,70 mm) (Ø body = 95,00 mm)	REF 144TA6651 (assembly) (for rubber tracks) (Ø body = 82,50 mm)			REF 143TA9910 (rubber) (300 x 109 x 35)
KUBOTA KX033				
REF 144TA6592 (for rubber tracks) (Ø flange = 122,00 mm) (Ø body = 98,00 mm)				REF 143TA9918 (rubber) (300 x 109 x 41)
KUBOTA KX040-4				
REF 145TA1988 (for rubber tracks) (Ø flange = 126,00 mm) (Ø body = 81,00 mm)	REF 143TA8979 (assembly) (for rubber tracks) (Ø body = 80,00 mm)	REF 145TA1989 (for rubber tracks)	REF 145TA1990 (front, with bracket assembly) (for rubber tracks)	REF 143TA9902 (rubber) (350 x 54,5 x 86)
KUBOTA KX045				
REF 144TA6589 (for rubber tracks) (Ø flange = 130,00 mm) (Ø body = 104,00 mm)	REF 144TA6671 (assembly) (for rubber tracks) (Ø body = 98,20 mm)			REF 164TA3076 (rubber) (400 x 72,5 x 72)
KUBOTA KX057-4				
REF 143TA8788 (for rubber tracks) (Ø flange = 135,00 mm) (Ø body = 85,60 mm)	REF 143TA8979 (assembly) (for rubber tracks) (Ø body = 80,00 mm)	REF 143TA9212 (for rubber tracks) (number of teeth = 19) (number of holes = 9)	REF 143TA9501 (front, with bracket assembly) (for rubber tracks)	REF 143TA9913 (rubber) (400 x 72,5 x 74) (with rail)
KUBOTA KX080-3				
<i>S/N: up to - 10175</i>				
REF 143TA8790 (for rubber tracks) (Ø flange = 132,00 mm) (Ø body = 110,00 mm)	REF 163TA9278 (assembly) (for rubber tracks) (Ø body = 80,00 mm)	REF 143TA9213 (for rubber tracks) (number of teeth = 19) (number of holes = 12)	REF 143TA9502 (front, with bracket assembly) (for rubber tracks) (Ø = 443,00 mm)	REF 163TA9684 (steel) (width = 600,00 mm) REF 143TA9914 (rubber) (450 x 81,5 x 76)
<i>S/N: 10176 - and up</i>				
REF 143TA8790 (for rubber tracks) (Ø flange = 132,00 mm) (Ø body = 110,00 mm)	REF 163TA9278 (assembly) (for rubber tracks) (Ø body = 80,00 mm)	REF 143TA9213 (for rubber tracks) (number of teeth = 19) (number of holes = 12)	REF 143TA9502 (front, with bracket assembly) (for rubber tracks) (Ø = 443,00 mm)	REF 163TA9685 (steel) (width = 600,00 mm) REF 143TA9914 (rubber) (450 x 81,5 x 76)
KUBOTA KX080-4				
REF 143TA8791 (for rubber tracks) (Ø flange = 132,00 mm) (Ø body = 110,00 mm)	REF 143TA8982 (assembly) (for rubber tracks) (Ø body = 104,00 mm)	REF 143TA9214 (for rubber tracks) (number of teeth = 19) (number of holes = 12)	REF 143TA9502 (front, with bracket assembly) (for rubber tracks) (Ø = 443,00 mm)	REF 143TA9916 (rubber) (450 x 81,5 x 76)



used for KUBOTA				
TRACK ROLLER	TOP ROLLER	SPROCKET	IDLER	TRACK
				

KUBOTA KX101

S/N: up to - 11740

REF 143TA8793 (for rubber tracks) (Ø flange = 122,00 mm) (Ø body = 98,00 mm)	REF 163TA9738 (assembly) (for rubber tracks) (Ø body = 82,50 mm)	REF 144TA1880 (for rubber tracks) (number of teeth = 23) (number of holes = 9)		REF 143TA9918 (rubber) (300 x 109 x 41)
---	---	--	--	---

S/N: up to - 50000

REF 143TA8793 (for rubber tracks) (Ø flange = 122,00 mm) (Ø body = 98,00 mm)	REF 163TA9738 (assembly) (for rubber tracks) (Ø body = 82,50 mm)	REF 144TA1880 (for rubber tracks) (number of teeth = 23) (number of holes = 9)	REF 144TA6597 (front, with bracket assembly) (for rubber tracks) (Ø = 338,00 mm)	
---	---	--	---	--

S/N: 11741 - 50000

REF 143TA8793 (for rubber tracks) (Ø flange = 122,00 mm) (Ø body = 98,00 mm)	REF 163TA9738 (assembly) (for rubber tracks) (Ø body = 82,50 mm)	REF 144TA1880 (for rubber tracks) (number of teeth = 23) (number of holes = 9)		REF 163TA9687 (rubber) (300 x 109 x 41)
---	---	--	--	---

S/N: 50001 - 50112

REF 143TA8793 (for rubber tracks) (Ø flange = 122,00 mm) (Ø body = 98,00 mm)	REF 163TA9738 (assembly) (for rubber tracks) (Ø body = 82,50 mm)	REF 144TA1880 (for rubber tracks) (number of teeth = 23) (number of holes = 9)		REF 143TA9918 (rubber) (300 x 109 x 41)
---	---	--	--	---

S/N: 50113 - 55000

REF 143TA8793 (for rubber tracks) (Ø flange = 122,00 mm) (Ø body = 98,00 mm)	REF 163TA9738 (assembly) (for rubber tracks) (Ø body = 82,50 mm)	REF 144TA1880 (for rubber tracks) (number of teeth = 23) (number of holes = 9)		REF 143TA9918 (rubber) (300 x 109 x 41)
---	---	--	--	---

S/N: 55000 - 55064

REF 143TA8793 (for rubber tracks) (Ø flange = 122,00 mm) (Ø body = 98,00 mm)	REF 163TA9738 (assembly) (for rubber tracks) (Ø body = 82,50 mm)	REF 144TA1880 (for rubber tracks) (number of teeth = 23) (number of holes = 9)	REF 144TA6597 (front, with bracket assembly) (for rubber tracks) (Ø = 338,00 mm)	
---	---	--	---	--

S/N: 55065 - and up

REF 143TA8793 (for rubber tracks) (Ø flange = 122,00 mm) (Ø body = 98,00 mm)	REF 163TA9738 (assembly) (for rubber tracks) (Ø body = 82,50 mm)	REF 144TA1880 (for rubber tracks) (number of teeth = 23) (number of holes = 9)	REF 144TA6597 (front, with bracket assembly) (for rubber tracks) (Ø = 338,00 mm)	
---	---	--	---	--

KUBOTA KX101-3

S/N: up to - 55643

REF 163TA9113 (for rubber tracks) (Ø flange = 124,00 mm) (Ø body = 80,00 mm)	REF 163TA9739 (assembly) (for rubber tracks) (Ø body = 79,00 mm)	REF 144TA1789 (for rubber tracks) (number of teeth = 21) (number of holes = 11)	REF 144TA6606 (front, with bracket assembly) (for rubber tracks) (Ø = 334,00 mm)	REF 163TA9689 (rubber) (300 x 53 x 84)
---	---	---	---	--

S/N: 55644 - and up

REF 163TA9718 (for rubber tracks) (Ø flange = 124,00 mm) (Ø body = 80,00 mm)	REF 163TA9739 (assembly) (for rubber tracks) (Ø body = 79,00 mm)	REF 144TA1789 (for rubber tracks) (number of teeth = 21) (number of holes = 11)	REF 144TA6606 (front, with bracket assembly) (for rubber tracks) (Ø = 334,00 mm)	REF 163TA9689 (rubber) (300 x 53 x 84)
---	---	---	---	--

KUBOTA KX101-3(Alfa)

REF 163TA9718 (for rubber tracks) (Ø flange = 124,00 mm) (Ø body = 80,00 mm)	REF 163TA9739 (assembly) (for rubber tracks) (Ø body = 79,00 mm)	REF 144TA1789 (for rubber tracks) (number of teeth = 21) (number of holes = 11)	REF 144TA6606 (front, with bracket assembly) (for rubber tracks) (Ø = 334,00 mm)	REF 163TA9689 (rubber) (300 x 53 x 84)
---	---	---	---	--





TRACKS & UNDERCARRIAGE PARTS



used for KUBOTA

used for KUBOTA				
TRACK ROLLER	TOP ROLLER	SPROCKET	IDLER	TRACK
				
KUBOTA KX121-2				
<i>S/N: up to - 55306</i>				
	REF 163TA9740 (assembly) (for rubber tracks) (Ø body = 82,50 mm)	REF 144TA1880 (for rubber tracks) (number of teeth = 23) (number of holes = 9)	REF 163TA9757 (front, with bracket assembly) (for rubber tracks) (Ø = 338,00 mm)	REF 164TA2043 (rubber) (350 x 54,5 x 86)
<i>S/N: up to - 55496</i>				
REF 143TA8795 (for rubber tracks) (Ø flange = 135,00 mm) (Ø body = 98,00 mm)	REF 163TA9740 (assembly) (for rubber tracks) (Ø body = 82,50 mm)		REF 163TA9757 (front, with bracket assembly) (for rubber tracks) (Ø = 338,00 mm)	REF 164TA2043 (rubber) (350 x 54,5 x 86)
<i>S/N: 55307 - and up</i>				
	REF 163TA9740 (assembly) (for rubber tracks) (Ø body = 82,50 mm)	REF 163TA9707 (for rubber tracks) (number of teeth = 23) (number of holes = 9)	REF 163TA9757 (front, with bracket assembly) (for rubber tracks) (Ø = 338,00 mm)	REF 164TA2043 (rubber) (350 x 54,5 x 86)
<i>S/N: 55497 - 55994</i>				
REF 163TA9719 (for rubber tracks) (Ø flange = 135,00 mm) (Ø body = 98,00 mm)	REF 163TA9740 (assembly) (for rubber tracks) (Ø body = 82,50 mm)		REF 163TA9757 (front, with bracket assembly) (for rubber tracks) (Ø = 338,00 mm)	REF 164TA2043 (rubber) (350 x 54,5 x 86)
<i>S/N: 55995 - and up</i>				
REF 163TA9720 (for rubber tracks) (Ø flange = 135,00 mm) (Ø body = 98,00 mm)	REF 163TA9740 (assembly) (for rubber tracks) (Ø body = 82,50 mm)		REF 163TA9757 (front, with bracket assembly) (for rubber tracks) (Ø = 338,00 mm)	REF 164TA2043 (rubber) (350 x 54,5 x 86)
KUBOTA KX121-3				
REF 163TA9721 (for rubber tracks) (Ø flange = 126,00 mm) (Ø body = 81,00 mm)	REF 143TA8979 (assembly) (for rubber tracks) (Ø body = 80,00 mm)	REF 163TA9708 (for rubber tracks) (number of teeth = 23) (number of holes = 9)	REF 144TA6607 (front, with bracket assembly) (for rubber tracks) (Ø = 344,00 mm)	REF 163TA9111 (rubber) (350 x 54,5 x 86)
KUBOTA KX121-3(Alfa)				
REF 163TA9721 (for rubber tracks) (Ø flange = 126,00 mm) (Ø body = 81,00 mm)	REF 143TA8979 (assembly) (for rubber tracks) (Ø body = 80,00 mm)	REF 163TA9707 (for rubber tracks) (number of teeth = 23) (number of holes = 9)	REF 144TA6607 (front, with bracket assembly) (for rubber tracks) (Ø = 344,00 mm)	REF 163TA9111 (rubber) (350 x 54,5 x 86)
KUBOTA KX151				
REF 144TA6589 (for rubber tracks) (Ø flange = 130,00 mm) (Ø body = 104,00 mm)	REF 163TA9741 (assembly) (for rubber tracks) (Ø body = 98,20 mm)	REF 144TA6588 (for rubber tracks) (number of teeth = 21) (number of holes = 9)	REF 163TA9758 (front, with bracket assembly) (for rubber tracks)	REF 143TA9903 (rubber) (400 x 72,5 x 72)
KUBOTA KX161				
<i>S/N: up to - 50851</i>				
			REF 144TA6590 (front, with bracket assembly) (for rubber and steel tracks) (Ø = 390,00 mm)	REF 143TA9922 (rubber) (400 x 72,5 x 72)
<i>S/N: 50852 - and up</i>				
			REF 144TA6608 (front, with bracket assembly) (for rubber tracks)	REF 143TA9922 (rubber) (400 x 72,5 x 72)



used for KUBOTA				
TRACK ROLLER	TOP ROLLER	SPROCKET	IDLER	TRACK
				
KUBOTA KX161-2				
<i>S/N: up to - 50622</i>				
	REF 163TA9742 (assembly) (for rubber and steel tracks) (Ø body = 98,00 mm)			REF 163TA9690 (rubber) (400 x 72,5 x 72)
<i>S/N: up to - 50651</i>				
REF 144TA6609 (for rubber tracks) (Ø flange = 145,00 mm) (Ø body = 105,00 mm)				REF 163TA9690 (rubber) (400 x 72,5 x 72)
<i>S/N: up to - 50851</i>				
REF 163TA9722 (for steel tracks)		REF 144TA6588 (for steel tracks) (number of teeth = 21) (number of holes = 9)	REF 163TA9759 (front, with bracket assembly) (for steel tracks) (Ø = 390,00 mm)	REF 163TA9690 (rubber) (400 x 72,5 x 72)
<i>S/N: up to - 50907</i>				
		REF 144TA6588 (for rubber tracks) (number of teeth = 21) (number of holes = 9)		REF 163TA9690 (rubber) (400 x 72,5 x 72)
<i>S/N: 50623 - 50651</i>				
	REF 163TA9742 (assembly) (for rubber tracks) (Ø body = 98,00 mm)			REF 163TA9690 (rubber) (400 x 72,5 x 72)
<i>S/N: 50652 - 50907</i>				
REF 163TA9724 (for rubber tracks) (Ø flange = 130,00 mm) (Ø body = 97,00 mm)				REF 163TA9690 (rubber) (400 x 72,5 x 72)
<i>S/N: 50652 - 51219</i>				
	REF 163TA9743 (assembly) (for rubber and steel tracks) (Ø body = 98,00 mm)			REF 163TA9690 (rubber) (400 x 72,5 x 72)
<i>S/N: 50852 - and up</i>				
			REF 144TA6608 (front, with bracket assembly) (for rubber and steel tracks)	REF 163TA9690 (rubber) (400 x 72,5 x 72)
<i>S/N: 50908 - and up</i>				
REF 163TA9723 (for rubber tracks) (Ø flange = 130,00 mm) (Ø body = 97,00 mm)		REF 163TA9709 (for rubber tracks) (number of teeth = 21) (number of holes = 9)		REF 163TA9690 (rubber) (400 x 72,5 x 72)
<i>S/N: 51220 - and up</i>				
	REF 163TA9114 (assembly) (for rubber tracks) (Ø body = 98,00 mm)			REF 163TA9690 (rubber) (400 x 72,5 x 72)
KUBOTA KX161-3				
REF 144TA6610 (for rubber tracks) (Ø flange = 135,00 mm) (Ø body = 85,60 mm)	REF 143TA8979 (assembly) (for rubber tracks) (Ø body = 80,00 mm)	REF 163TA9710 (for rubber tracks) (number of teeth = 19) (number of holes = 9)	REF 163TA9760 (front, with bracket assembly) (for rubber tracks) (Ø = 372,00 mm)	REF 163TA9691 (rubber) (400 x 72,5 x 74) (with rail)



used for KUBOTA				
TRACK ROLLER	TOP ROLLER	SPROCKET	IDLER	TRACK
				
KUBOTA KX163-5				
		REF 143TA9212 (for rubber tracks) (number of teeth = 19) (number of holes = 9) (total height = 42,00 mm)		
KUBOTA KX165-5				
		REF 143TA9212 (for rubber tracks) (number of teeth = 19) (number of holes = 9) (total height = 42,00 mm)		
KUBOTA KX191(Alfa)				
REF 144TA6666 (for rubber tracks)	REF 144TA6673 (assembly) (for rubber tracks) (Ø body = 98,20 mm)			REF 164TA3071 (rubber) (450 x 81 x 72)
KUBOTA KX251				
<i>S/N: up to - 10060</i>				
REF 144TA6599 (for rubber and steel tracks) (outer guide) (Ø flange = 158,00 mm) (Ø body = 132,00 mm)	REF 163TA9744 (assembly) (for rubber and steel tracks)	REF 144TA6598 (for rubber tracks) (number of teeth = 23) (number of holes = 12)	REF 163TA9762 (front, with bracket assembly) (for steel tracks)	REF 143TA9923 (rubber) (450 x 71 x 86)
REF 163TA9725 (for rubber tracks) (Ø flange = 149,00 mm) (Ø body = 125,00 mm)			REF 163TA9761 (front, with bracket assembly) (for rubber tracks)	
			REF 143TA9341 (front, with bracket assembly) (for rubber and steel tracks)	
<i>For all other serial ranges applicable</i>				
REF 144TA6599 (for rubber and steel tracks) (outer guide) (Ø flange = 158,00 mm) (Ø body = 132,00 mm)	REF 163TA9744 (assembly) (for rubber and steel tracks)	REF 144TA6598 (for rubber tracks) (number of teeth = 23) (number of holes = 12)	REF 163TA9761 (front, with bracket assembly) (for rubber tracks)	REF 143TA9923 (rubber) (450 x 71 x 86)
REF 163TA9725 (for rubber tracks) (Ø flange = 149,00 mm) (Ø body = 125,00 mm)			REF 143TA9341 (front, with bracket assembly) (for rubber and steel tracks)	
KUBOTA KX36				
<i>S/N: up to - 12358</i>				
REF 163TA9726 (for rubber tracks)		REF 144TA6583 (for rubber tracks) (number of teeth = 19) (number of holes = 8)	REF 163TA9763 (front, with bracket assembly) (for rubber tracks) (Ø = 240,00 mm)	REF 163TA9692 (rubber) (230 x 96 x 30)
<i>S/N: 12359 - and up</i>				
REF 163TA9726 (for rubber tracks)		REF 144TA6583 (for rubber tracks) (number of teeth = 19) (number of holes = 8)	REF 163TA9765 (front, with bracket assembly) (for rubber tracks)	REF 163TA9692 (rubber) (230 x 96 x 30)
<i>S/N: 55001 - 55043</i>				
REF 163TA9726 (for rubber tracks)		REF 144TA6583 (for rubber tracks) (number of teeth = 19) (number of holes = 8)	REF 163TA9763 (front, with bracket assembly) (for rubber tracks) (Ø = 240,00 mm)	REF 163TA9692 (rubber) (230 x 96 x 30)
<i>S/N: 55044 - and up</i>				
REF 163TA9726 (for rubber tracks)		REF 144TA6583 (for rubber tracks) (number of teeth = 19) (number of holes = 8)	REF 163TA9764 (front, with bracket assembly) (for rubber tracks) (Ø = 240,00 mm)	REF 163TA9692 (rubber) (230 x 96 x 30)



used for KUBOTA				
TRACK ROLLER	TOP ROLLER	SPROCKET	IDLER	TRACK
				
KUBOTA KX36-2				
REF 144TA6612 (for rubber tracks) (Ø flange = 113,00 mm) (Ø body = 80,00 mm)		REF 143TA9215 (for rubber tracks) (number of teeth = 19) (number of holes = 8)	REF 144TA6614 (front, with bracket assembly) (for rubber tracks) (Ø = 240,00 mm)	REF 163TA9693 (rubber) (230 x 96 x 30)
KUBOTA KX36-3GL				
REF 144TA6602 (for rubber tracks) (Ø flange = 109,00 mm) (Ø body = 80,00 mm)				REF 143TA9924 (rubber) (230 x 96 x 32)
KUBOTA KX41				
<i>S/N: up to - 12259</i>				
REF 163TA9727 (for rubber tracks) (Ø flange = 98,00 mm) (Ø body = 80,00 mm)		REF 144TA6583 (for rubber tracks) (number of teeth = 19) (number of holes = 8)	REF 163TA9763 (front, with bracket assembly) (for rubber tracks) (Ø = 240,00 mm)	REF 143TA9899 (rubber) (230 x 96 x 30)
<i>S/N: 12260 - 55000</i>				
REF 163TA9727 (for rubber tracks) (Ø flange = 98,00 mm) (Ø body = 80,00 mm)		REF 144TA6583 (for rubber tracks) (number of teeth = 19) (number of holes = 8)	REF 163TA9765 (front, with bracket assembly) (for rubber tracks)	REF 143TA9899 (rubber) (230 x 96 x 30)
<i>S/N: 55001 - 55403</i>				
REF 163TA9727 (for rubber tracks) (Ø flange = 98,00 mm) (Ø body = 80,00 mm)		REF 144TA6583 (for rubber tracks) (number of teeth = 19) (number of holes = 8)	REF 163TA9763 (front, with bracket assembly) (for rubber tracks) (Ø = 240,00 mm)	REF 143TA9899 (rubber) (230 x 96 x 30)
<i>S/N: 55404 - and up</i>				
REF 163TA9727 (for rubber tracks) (Ø flange = 98,00 mm) (Ø body = 80,00 mm)		REF 144TA6583 (for rubber tracks) (number of teeth = 19) (number of holes = 8)	REF 163TA9765 (front, with bracket assembly) (for rubber tracks)	REF 143TA9899 (rubber) (230 x 96 x 30)
KUBOTA KX41-2				
REF 144TA6612 (for rubber tracks) (Ø flange = 113,00 mm) (Ø body = 80,00 mm)		REF 144TA6583 (for rubber tracks) (number of teeth = 19) (number of holes = 8)	REF 164TA2147 (front, with bracket assembly) (for rubber tracks)	REF 163TA9693 (rubber) (230 x 96 x 30)
KUBOTA KX41-2S(V)				
REF 144TA6612 (for rubber tracks) (standard) (Ø flange = 113,00 mm) (Ø body = 80,00 mm)		REF 143TA9215 (for rubber tracks) (number of teeth = 19) (number of holes = 8)	REF 144TA6614 (front, with bracket assembly) (for rubber tracks) (standard) (Ø = 240,00 mm)	
REF 163TA9728 (for rubber tracks) (variable) (Ø flange = 116,00 mm) (Ø body = 80,00 mm)			REF 163TA9766 (front, with bracket assembly) (for rubber tracks) (variable) (Ø = 242,00 mm)	
KUBOTA KX41-2SC				
			REF 144TA6601 (front, with bracket assembly) (for rubber tracks)	REF 145TA1985 (rubber) (230 x 96 x 32)
KUBOTA KX41-2SV				
				REF 143TA9928 (rubber) (230 x 96 x 35)



used for KUBOTA				
TRACK ROLLER	TOP ROLLER	SPROCKET	IDLER	TRACK
				
KUBOTA KX41-2V				
REF 144TA6582 (for rubber tracks) (Ø flange = 116,00 mm) (Ø body = 80,00 mm)				REF 143TA9928 (rubber) (230 x 96 x 35)
KUBOTA KX41-3S(V)				
REF 144TA6602 (for rubber tracks) (Ø flange = 109,00 mm) (Ø body = 80,00 mm)		REF 163TA9711 (for rubber tracks) (number of teeth = 19) (number of holes = 9)	REF 163TA9254 (front, with bracket assembly) (for rubber tracks) (Ø = 242,00 mm)	REF 163TA9694 (rubber) (230 x 96 x 32) (standard) REF 163TA9695 (rubber) (230 x 96 x 35) (optional)
KUBOTA KX41-3V				
REF 144TA6602 (for rubber tracks) (Ø flange = 109,00 mm) (Ø body = 80,00 mm)			REF 144TA6601 (front, with bracket assembly) (for rubber tracks)	REF 143TA9928 (rubber) (230 x 96 x 35)
KUBOTA KX41SV				
		REF 143TA9215 (for rubber tracks) (number of teeth = 19) (number of holes = 8)		REF 143TA9899 (rubber) (230 x 96 x 30)
KUBOTA KX61(H)				
<i>S/N: up to - 11754</i>				
REF 163TA9729 (for rubber tracks) (Ø flange = 123,70 mm) (Ø body = 95,00 mm)		REF 163TA9712 (for rubber tracks) (number of teeth = 23) (number of holes = 9)	REF 163TA9767 (front, with bracket assembly) (for rubber tracks)	REF 163TA9696 (rubber) (260 x 109 x 35)
<i>S/N: 11755 - 50000</i>				
REF 163TA9729 (for rubber tracks) (Ø flange = 123,70 mm) (Ø body = 95,00 mm)		REF 163TA9712 (for rubber tracks) (number of teeth = 23) (number of holes = 9)	REF 163TA9767 (front, with bracket assembly) (for rubber tracks)	REF 163TA9697 (rubber) (260 x 109 x 35)
<i>S/N: 50001 - 50095</i>				
REF 163TA9729 (for rubber tracks) (Ø flange = 123,70 mm) (Ø body = 95,00 mm)		REF 163TA9712 (for rubber tracks) (number of teeth = 23) (number of holes = 9)	REF 163TA9767 (front, with bracket assembly) (for rubber tracks)	REF 163TA9696 (rubber) (260 x 109 x 35)
<i>S/N: 50096 - 55000</i>				
REF 163TA9729 (for rubber tracks) (Ø flange = 123,70 mm) (Ø body = 95,00 mm)		REF 163TA9712 (for rubber tracks) (number of teeth = 23) (number of holes = 9)	REF 163TA9767 (front, with bracket assembly) (for rubber tracks)	REF 163TA9697 (rubber) (260 x 109 x 35)
<i>S/N: 55001 - 55075</i>				
REF 163TA9729 (for rubber tracks) (Ø flange = 123,70 mm) (Ø body = 95,00 mm)		REF 163TA9712 (for rubber tracks) (number of teeth = 23) (number of holes = 9)	REF 163TA9767 (front, with bracket assembly) (for rubber tracks)	
<i>S/N: 55076 - and up</i>				
REF 163TA9729 (for rubber tracks) (Ø flange = 123,70 mm) (Ø body = 95,00 mm)		REF 163TA9712 (for rubber tracks) (number of teeth = 23) (number of holes = 9)	REF 144TA6596 (front, with bracket assembly) (for rubber tracks) (Ø = 338,00 mm) REF 163TA9767 (front, with bracket assembly) (for rubber tracks)	



used for KUBOTA				
TRACK ROLLER	TOP ROLLER	SPROCKET	IDLER	TRACK
				
KUBOTA KX61-2				
REF 144TA6695 (for rubber tracks) (Ø flange = 136,00 mm) (Ø body = 96,00 mm)		REF 144TA6613 (for rubber tracks) (number of teeth = 23) (number of holes = 9)	REF 144TA6596 (front, with bracket assembly) (for rubber tracks) (Ø = 338,00 mm)	REF 164TA2044 (rubber) (260 x 109 x 37)
KUBOTA KX61-2(Alfa)				
REF 144TA6694 (for rubber tracks) (Ø flange = 136,00 mm) (Ø body = 96,00 mm)		REF 144TA6613 (for rubber tracks) (number of teeth = 23) (number of holes = 9)	REF 144TA6596 (front, with bracket assembly) (for rubber tracks) (Ø = 338,00 mm)	REF 143TA9909 (rubber) (260 x 109 x 35) REF 164TA2044 (rubber) (260 x 109 x 37)
KUBOTA KX61-3				
REF 144TA6698 (for rubber tracks) (Ø flange = 124,00 mm) (Ø body = 80,00 mm)	REF 144TA6657 (assembly) (for rubber tracks) (Ø body = 79,00 mm)	REF 144TA6604 (for rubber tracks) (number of teeth = 21) (number of holes = 10)	REF 163TA9254 (front, with bracket assembly) (for rubber tracks) (Ø = 242,00 mm)	REF 143TA9925 (rubber) (300 x 53 x 80)
KUBOTA KX71				
REF 144TA6686 (for rubber tracks) (Ø flange = 123,70 mm) (Ø body = 95,00 mm)	REF 144TA6652 (assembly) (for rubber tracks) (Ø body = 82,50 mm)	REF 163TA9712 (for rubber tracks) (number of teeth = 23) (number of holes = 9)	REF 163TA9767 (front, with bracket assembly) (for rubber tracks)	REF 143TA9910 (rubber) (300 x 109 x 35)
KUBOTA KX71-2				
	REF 144TA6653 (assembly) (for rubber tracks) (Ø body = 82,50 mm)	REF 144TA6613 (for rubber tracks) (number of teeth = 23) (number of holes = 9)		REF 163TA9698 (rubber) (300 x 52,5 x 80)
KUBOTA KX71-2(Alfa)				
		REF 144TA6613 (for rubber tracks) (number of teeth = 23) (number of holes = 9)		REF 163TA9698 (rubber) (300 x 52,5 x 80)
KUBOTA KX71-2(ALPHA)				
REF 163TA9730 (for rubber tracks) (Ø flange = 136,00 mm) (Ø body = 96,00 mm)	REF 163TA9740 (assembly) (for rubber tracks) (Ø body = 82,50 mm)		REF 144TA6596 (front, with bracket assembly) (for rubber tracks) (Ø = 338,00 mm)	
KUBOTA KX71-3				
<i>S/N: up to - 55075</i>				
REF 147TA4096 (for rubber tracks) (Ø flange = 124,00 mm) (Ø body = 80,00 mm)	REF 144TA6658 (assembly) (for rubber tracks) (Ø body = 79,00 mm)	REF 144TA6632 (for rubber tracks) (number of teeth = 21) (number of holes = 11)	REF 144TA6600 (front, with bracket assembly) (for rubber tracks) (Ø = 315,00 mm)	REF 152TA1902 (rubber) (300 x 53 x 80)
<i>For all other serial ranges applicable</i>				
	REF 144TA6658 (assembly) (for rubber tracks) (Ø body = 79,00 mm)	REF 144TA6632 (for rubber tracks) (number of teeth = 21) (number of holes = 11)	REF 144TA6600 (front, with bracket assembly) (for rubber tracks) (Ø = 315,00 mm)	REF 152TA1902 (rubber) (300 x 53 x 80)
KUBOTA KX75UR-3				
REF 144TA6617 (for rubber tracks) (Ø flange = 132,00 mm) (Ø body = 110,00 mm)	REF 144TA6619 (assembly) (for rubber tracks) (Ø flange = 100,00 mm) (Ø body = 86,00 mm)	REF 144TA6616 (for rubber tracks) (number of teeth = 21) (number of holes = 12)	REF 144TA6618 (front, with bracket assembly) (for rubber tracks)	REF 164TA9687 (rubber) (450 x 81 x 76)

TRACKS & UNDERCARRIAGE PARTS



used for KUBOTA

used for KUBOTA				
TRACK ROLLER	TOP ROLLER	SPROCKET	IDLER	TRACK
				
KUBOTA KX91-2				
<i>S/N: up to - 55466</i>				
REF 163TA9731 (for rubber tracks)	REF 144TA6654 (assembly) (for rubber tracks) (Ø body = 82,50 mm)	REF 144TA6587 (for rubber tracks) (number of teeth = 23) (number of holes = 9)	REF 144TA6596 (front, with bracket assembly) (for rubber tracks) (Ø = 338,00 mm)	REF 163TA9698 (rubber) (300 x 52,5 x 80)
<i>S/N: 55467 - and up</i>				
REF 144TA6696 (for rubber tracks) (Ø flange = 136,00 mm) (Ø body = 96,00 mm)	REF 144TA6654 (assembly) (for rubber tracks) (Ø body = 82,50 mm)	REF 144TA6587 (for rubber tracks) (number of teeth = 23) (number of holes = 9)	REF 144TA6596 (front, with bracket assembly) (for rubber tracks) (Ø = 338,00 mm)	REF 163TA9698 (rubber) (300 x 52,5 x 80)
KUBOTA KX91-3				
REF 144TA6699 (for rubber tracks) (Ø flange = 124,00 mm) (Ø body = 80,00 mm)	REF 144TA6659 (assembly) (for rubber tracks) (Ø body = 79,00 mm)	REF 144TA6633 (for rubber tracks) (number of teeth = 21) (number of holes = 12)	REF 163TA9768 (front, with bracket assembly) (for rubber tracks)	REF 143TA9925 (rubber) (300 x 53 x 80)
KUBOTA RC23				
REF 144TA6669 (for rubber tracks)				
KUBOTA RX301(Alfa)				
REF 144TA6687 (for rubber tracks) (Ø flange = 123,70 mm) (Ø body = 95,00 mm)		REF 144TA6640 (for rubber tracks) (number of teeth = 23) (number of holes = 9)		REF 143TA9918 (rubber) (300 x 109 x 41)
KUBOTA RX303				
REF 144TA6700 (for rubber tracks) (Ø flange = 124,00 mm) (Ø body = 80,00 mm)	REF 144TA6623 (assembly) (for rubber tracks) (Ø body = 80,00 mm)	REF 144TA6634 (for rubber tracks) (number of teeth = 21) (number of holes = 12)	REF 144TA6606 (front, with bracket assembly) (for rubber tracks) (Ø = 334,00 mm)	REF 143TA9926 (rubber) (300 x 53 x 84)
KUBOTA RX502				
	REF 144TA6674 (assembly) (for rubber tracks) (Ø body = 98,20 mm)			REF 163TA9256 (rubber) (400 x 72,5 x 74)
KUBOTA U10				
REF 145TA1968 (for rubber tracks) (Ø flange = 129,50 mm) (Ø body = 68,00 mm)		REF 163TA9250 (for rubber tracks)	REF 144TA6594 (front, with bracket assembly) (for rubber tracks) (Ø = 248,00 mm)	REF 163TA9699 (rubber) (180 x 72 x 40) (with rail)
KUBOTA U10(ALPHA)				
REF 163TA9249 (for rubber tracks)		REF 163TA9250 (for rubber tracks)	REF 163TA9268 (front, with bracket assembly) (for rubber tracks) (Ø = 248,00 mm)	REF 163TA9699 (rubber) (180 x 72 x 40) (with rail)
KUBOTA U10-3				
REF 163TA9266 (for rubber tracks) (Ø flange = 124,00 mm) (Ø body = 60,00 mm)		REF 163TA9250 (for rubber tracks)	REF 144TA6594 (front, with bracket assembly) (for rubber tracks) (Ø = 248,00 mm)	REF 143TA9927 (rubber) (180 x 72 x 40)
KUBOTA U15(Alfa)				
REF 163TA9733 (for rubber tracks) (Ø flange = 109,00 mm) (Ø body = 80,00 mm)			REF 163TA9771 (front, with bracket assembly) (for rubber tracks) (Ø = 242,00 mm)	REF 143TA9928 (rubber) (230 x 96 x 35)







used for KUBOTA				
TRACK ROLLER	TOP ROLLER	SPROCKET	IDLER	TRACK
				
KUBOTA U15(ALPHA)				
		REF 163TA9714 (for rubber tracks)		
KUBOTA U15(EU)				
<i>S/N: up to - 11547</i>				
REF 163TA9732 (for rubber tracks) (Ø flange = 116,00 mm) (Ø body = 80,00 mm)		REF 163TA9713 (for rubber tracks)	REF 163TA9769 (front, with bracket assembly) (for rubber tracks)	REF 143TA9928 (rubber) (230 x 96 x 35)
<i>S/N: 11548 - and up</i>				
REF 163TA9732 (for rubber tracks) (Ø flange = 116,00 mm) (Ø body = 80,00 mm)		REF 163TA9713 (for rubber tracks)	REF 163TA9770 (front, with bracket assembly) (for rubber tracks)	REF 143TA9928 (rubber) (230 x 96 x 35)
KUBOTA U20				
REF 145TA3328 (for rubber tracks) (inner guide) (Ø flange = 119,50 mm) (Ø body = 80,00 mm)		REF 144TA6660 (for rubber tracks) (number of teeth = 23) (number of holes = 9)	REF 163TA9772 (front, with bracket assembly) (for rubber tracks)	REF 163TA9112 (rubber) (260 x 96 x 41)
KUBOTA U20-3				
REF 144TA6603 (for rubber tracks) (Ø flange = 107,00 mm) (Ø body = 62,00 mm)	REF 144TA6605 (assembly) (for rubber tracks) (Ø body = 79,00 mm)	REF 144TA1789 (for rubber tracks) (number of teeth = 21) (number of holes = 11)	REF 145TA1981 (front, with bracket assembly) (for rubber tracks) (Ø = 279,00 mm)	REF 143TA9929 (rubber) (250 x 47 x 84)
KUBOTA U25				
REF 144TA6701 (for rubber tracks) (Ø flange = 124,00 mm) (Ø body = 80,00 mm)		REF 144TA6604 (for rubber tracks) (number of teeth = 21) (number of holes = 10)	REF 163TA9254 (front, with bracket assembly) (for rubber tracks) (Ø = 242,00 mm)	REF 143TA9925 (rubber) (300 x 53 x 80)
KUBOTA U25-3				
REF 147TA4096 (for rubber tracks) (Ø flange = 124,00 mm) (Ø body = 80,00 mm)	REF 144TA6605 (assembly) (for rubber tracks) (Ø body = 79,00 mm)	REF 144TA6604 (for rubber tracks) (number of teeth = 21) (number of holes = 10)	REF 144TA6600 (front, with bracket assembly) (for rubber tracks) (Ø = 315,00 mm)	REF 143TA9925 (rubber) (300 x 53 x 80)
KUBOTA U25-3(ALPHA)				
REF 147TA4096 (for rubber tracks) (Ø flange = 124,00 mm) (Ø body = 80,00 mm)	REF 144TA6605 (assembly) (for rubber tracks) (Ø body = 79,00 mm)	REF 144TA6604 (for rubber tracks) (number of teeth = 21) (number of holes = 10)	REF 144TA6600 (front, with bracket assembly) (for rubber tracks) (Ø = 315,00 mm)	REF 163TA9700 (rubber) (300 x 53 x 80)
KUBOTA U30				
REF 144TA6688 (for rubber tracks) (Ø flange = 135,00 mm) (Ø body = 98,00 mm)		REF 144TA6587 (for rubber tracks) (number of teeth = 23) (number of holes = 9)		REF 163TA9701 (rubber) (300 x 52,5 x 84)
KUBOTA U35				
REF 163TA9734 (for rubber tracks) (Ø flange = 124,00 mm) (Ø body = 80,00 mm)	REF 144TA6605 (assembly) (for rubber tracks) (Ø body = 79,00 mm)	REF 144TA6587 (for rubber tracks) (number of teeth = 23) (number of holes = 9)	REF 144TA6606 (front, with bracket assembly) (for rubber tracks) (Ø = 334,00 mm)	REF 163TA9701 (rubber) (300 x 52,5 x 84)
KUBOTA U35(EU)				
<i>S/N: up to - 10526</i>				
REF 163TA9735 (for rubber tracks) (Ø flange = 135,00 mm) (Ø body = 98,00 mm)	REF 163TA9745 (assembly) (for rubber tracks) (Ø body = 82,50 mm)	REF 144TA6587 (for rubber tracks) (number of teeth = 23) (number of holes = 9)	REF 163TA9773 (front, with bracket assembly) (for rubber tracks)	



used for KUBOTA				
TRACK ROLLER	TOP ROLLER	SPROCKET	IDLER	TRACK
				
<i>S/N: 10527 - and up</i>				
REF 163TA9736 (for rubber tracks)	REF 163TA9745 (assembly) (for rubber tracks) (Ø body = 82,50 mm)	REF 144TA6587 (for rubber tracks) (number of teeth = 23) (number of holes = 9)	REF 163TA9773 (front, with bracket assembly) (for rubber tracks)	
KUBOTA U35-3				
REF 144TA6702 (for rubber tracks) (Ø flange = 124,00 mm) (Ø body = 80,00 mm)	REF 163TA9739 (assembly) (for rubber tracks) (Ø body = 79,00 mm)	REF 144TA6635 (for rubber tracks) (number of teeth = 21) (number of holes = 12)	REF 144TA6606 (front, with bracket assembly) (for rubber tracks) (Ø = 334,00 mm)	REF 143TA9931 (rubber) (300 x 53 x 84)
KUBOTA U35-3(ALPHA)2				
<i>S/N: 80000 - 80836</i>				
REF 163TA9718 (for rubber tracks) (Ø flange = 124,00 mm) (Ø body = 80,00 mm)		REF 144TA1789 (for rubber tracks) (number of teeth = 21) (number of holes = 11)	REF 163TA9774 (front, with bracket assembly) (for rubber tracks) (Ø = 334,00 mm)	REF 163TA9702 (rubber) (300 x 53 x 84)
<i>S/N: 80000 - 80888</i>				
REF 163TA9718 (for rubber tracks) (Ø flange = 124,00 mm) (Ø body = 80,00 mm)	REF 163TA9739 (assembly) (for rubber tracks) (Ø body = 79,00 mm)	REF 144TA1789 (for rubber tracks) (number of teeth = 21) (number of holes = 11)	REF 163TA9774 (front, with bracket assembly) (for rubber tracks) (Ø = 334,00 mm)	
<i>S/N: 80837 - and up</i>				
REF 163TA9718 (for rubber tracks) (Ø flange = 124,00 mm) (Ø body = 80,00 mm)		REF 144TA1789 (for rubber tracks) (number of teeth = 21) (number of holes = 11)	REF 163TA9774 (front, with bracket assembly) (for rubber tracks) (Ø = 334,00 mm)	REF 163TA9703 (rubber) (300 x 53 x 84)
<i>S/N: 80889 - and up</i>				
REF 163TA9718 (for rubber tracks) (Ø flange = 124,00 mm) (Ø body = 80,00 mm)	REF 163TA9746 (assembly) (for rubber tracks) (Ø body = 79,00 mm)	REF 144TA1789 (for rubber tracks) (number of teeth = 21) (number of holes = 11)	REF 163TA9774 (front, with bracket assembly) (for rubber tracks) (Ø = 334,00 mm)	
KUBOTA U35-4				
REF 145TA1974 (for rubber tracks)	REF 145TA1975 (assembly) (for rubber tracks) (Ø body = 76,20 mm)	REF 145TA1976 (for rubber tracks)	REF 145TA1977 (front, with bracket assembly) (for rubber tracks)	REF 145TA1978 (rubber) (300 x 53 x 84)
KUBOTA U45				
REF 144TA6609 (for rubber tracks) (Ø flange = 145,00 mm) (Ø body = 105,00 mm)	REF 144TA6625 (assembly) (for rubber tracks) (Ø body = 80,00 mm)		REF 144TA6677 (front, with bracket assembly) (for rubber tracks)	REF 143TA9903 (rubber) (400 x 72,5 x 72)
KUBOTA U45(EU)				
REF 163TA9723 (for rubber tracks) (Ø flange = 130,00 mm) (Ø body = 97,00 mm)	REF 163TA9747 (assembly) (for rubber tracks) (Ø body = 84,00 mm)	REF 163TA9715 (for rubber tracks) (number of teeth = 19) (number of holes = 12)	REF 163TA9775 (front, with bracket assembly) (for rubber tracks)	REF 163TA9704 (rubber) (400 x 72,5 x 72)
KUBOTA U45-3				
REF 144TA6610 (for rubber tracks) (Ø flange = 135,00 mm) (Ø body = 85,60 mm)	REF 144TA6626 (assembly) (for rubber tracks) (Ø body = 80,00 mm)	REF 163TA9715 (for rubber tracks) (number of teeth = 19) (number of holes = 12)	REF 144TA6611 (front, with bracket assembly) (for rubber tracks) (Ø = 372,00 mm)	REF 163TA9691 (rubber) (400 x 72,5 x 74) (with rail)
KUBOTA U45-3(Alfa)				
REF 144TA6610 (for rubber tracks) (Ø flange = 135,00 mm) (Ø body = 85,60 mm)	REF 144TA6627 (assembly) (for rubber tracks) (Ø body = 80,00 mm)		REF 144TA6611 (front, with bracket assembly) (for rubber tracks) (Ø = 372,00 mm)	REF 163TA9691 (rubber) (400 x 72,5 x 74) (with rail)



used for KUBOTA				
TRACK ROLLER	TOP ROLLER	SPROCKET	IDLER	TRACK
				
KUBOTA U45-3(ALPHA)				
		REF 163TA9710 (for rubber tracks) (number of teeth = 19) (number of holes = 9)		
KUBOTA U48-4				
<i>S/N: up to - 51310</i>				
REF 143TA8788 (∅ flange = 135,00 mm) (∅ body = 85,60 mm)	REF 145TA1980 (assembly) (∅ body = 80,00 mm)	REF 143TA9212 (number of teeth = 19) (number of holes = 9)	REF 143TA9501 (front, with bracket assembly)	REF 164TA1542 (rubber) (400 x 72,5 x 74) (with rail)
<i>S/N: 51311 - 51492</i>				
REF 143TA8789 (∅ flange = 135,00 mm) (∅ body = 85,60 mm)	REF 145TA1980 (assembly) (∅ body = 80,00 mm)	REF 143TA9212 (number of teeth = 19) (number of holes = 9)	REF 143TA9501 (front, with bracket assembly)	REF 164TA1542 (rubber) (400 x 72,5 x 74) (with rail)
<i>S/N: 51493 - and up</i>				
REF 145TA1979 (∅ flange = 135,00 mm) (∅ body = 85,60 mm)	REF 145TA1980 (assembly) (∅ body = 80,00 mm)	REF 143TA9212 (number of teeth = 19) (number of holes = 9)	REF 143TA9501 (front, with bracket assembly)	REF 164TA1542 (rubber) (400 x 72,5 x 74) (with rail)
KUBOTA U50-3(ALPHA)				
REF 144TA6610 (for rubber tracks) (∅ flange = 135,00 mm) (∅ body = 85,60 mm)	REF 144TA6628 (assembly) (for rubber tracks) (∅ body = 80,00 mm)	REF 163TA9710 (for rubber tracks) (number of teeth = 19) (number of holes = 9)	REF 144TA6611 (front, with bracket assembly) (for rubber tracks) (∅ = 372,00 mm)	REF 143TA4265 (rubber) (400 x 72,5 x 74) (with rail)
KUBOTA U55-4				
REF 145TA1979 (for rubber tracks) (∅ flange = 135,00 mm) (∅ body = 85,60 mm)	REF 145TA1980 (assembly) (for rubber tracks) (∅ body = 80,00 mm)	REF 143TA9212 (for rubber tracks) (number of teeth = 19) (number of holes = 9)	REF 143TA9501 (front, with bracket assembly) (for rubber tracks)	REF 143TA9913 (rubber) (400 x 72,5 x 74) (with rail)



USED FOR
LIBRA





TRACKS & UNDERCARRIAGE PARTS



used for LIBRA

used for LIBRA				
TRACK ROLLER	TOP ROLLER	SPROCKET	IDLER	TRACK
				
LIBRA 114S				
REF 144TA8420 (for rubber tracks) (Ø flange = 130,00 mm) (Ø body = 63,00 mm)		REF 144TA8117 (for rubber tracks)	REF 144TA7943 (front, with bracket assembly) (for rubber tracks)	REF 143TA9932 (rubber) (230 x 72 x 45)
LIBRA 118SV				
		REF 144TA8118 (for rubber tracks)		REF 143TA9932 (rubber) (230 x 72 x 45)
LIBRA 125S				
REF 144TA8421 (for rubber tracks) (Ø flange = 108,00 mm) (Ø body = 85,00 mm)	REF 144TA8285 (assembly) (for rubber tracks)	REF 144TA8119 (for rubber tracks)	REF 144TA7944 (front, with bracket assembly) (for rubber tracks)	REF 143TA9648 (rubber) (300 x 109 x 36)
LIBRA 130S				
REF 144TA8422 (for rubber tracks) (Ø flange = 108,00 mm) (Ø body = 85,00 mm)	REF 144TA8286 (assembly) (for rubber tracks)	REF 144TA8120 (for rubber tracks)		REF 143TA9678 (rubber) (300 x 109 x 39)
LIBRA 135S				
REF 144TA8423 (for rubber tracks) (Ø flange = 108,00 mm) (Ø body = 85,00 mm)		REF 144TA8121 (for rubber tracks) (number of teeth = 23) (number of holes = 9)	REF 144TA7945 (front, with bracket assembly) (for rubber tracks)	REF 143TA9678 (rubber) (300 x 109 x 39)
LIBRA 150S				
REF 144TA8424 (for rubber tracks) (Ø flange = 140,00 mm) (Ø body = 110,00 mm)		REF 144TA1808 (for rubber tracks) (number of teeth = 19) (number of holes = 9)		REF 164TA3031 (rubber) (400 x 72,5 x 72)
LIBRA 216S				
REF 144TA8431 (for rubber tracks) (Ø flange = 129,50 mm) (Ø body = 68,00 mm)				REF 143TA9932 (rubber) (230 x 72 x 45)
LIBRA 218SV				
REF 144TA8432 (for rubber tracks) (Ø flange = 129,50 mm) (Ø body = 68,00 mm)		REF 144TA8125 (for rubber tracks) (number of teeth = 14) (number of holes = 8)		REF 143TA9716 (rubber) (230 x 96 x 35)
LIBRA 225S				
	REF 144TA8287 (assembly) (for rubber tracks)	REF 144TA1884 (for rubber tracks) (number of teeth = 23) (number of holes = 9)		REF 144TA1022 (rubber) (300 x 55 x 72)
LIBRA 229S				
REF 144TA8433 (for rubber tracks) (Ø flange = 108,00 mm) (Ø body = 85,00 mm)		REF 144TA8126 (for rubber tracks) (number of teeth = 23) (number of holes = 9)		REF 143TA9933 (rubber) (300 x 55 x 78)
LIBRA 230S				
REF 144TA8434 (for rubber tracks) (Ø flange = 108,00 mm) (Ø body = 85,00 mm)	REF 144TA8288 (assembly) (for rubber tracks)	REF 144TA8127 (for rubber tracks) (number of teeth = 23) (number of holes = 9)		REF 143TA9933 (rubber) (300 x 55 x 78)
LIBRA 234S				
REF 144TA8435 (for rubber tracks)	REF 144TA8676 (assembly) (for rubber tracks)	REF 144TA8677 (for rubber tracks) (number of teeth = 23) (number of holes = 9)	REF 144TA8678 (front, with bracket assembly) (for rubber tracks)	REF 143TA9933 (rubber) (300 x 55 x 78)







used for LIBRA				
TRACK ROLLER	TOP ROLLER	SPROCKET	IDLER	TRACK
				
LIBRA 235S				
REF 144TA8436 (for rubber tracks) (Ø flange = 108,00 mm) (Ø body = 85,00 mm)		REF 144TA8129 (for rubber tracks) (number of teeth = 23) (number of holes = 9)		REF 143TA9933 (rubber) (300 x 55 x 78)
LIBRA 254S				
REF 144TA8439 (for rubber tracks) (Ø flange = 140,00 mm) (Ø body = 110,00 mm)		REF 144TA8130 (for rubber tracks) (number of teeth = 19) (number of holes = 9)	REF 144TA7950 (front, with bracket assembly) (for rubber tracks) (Ø = 375,00 mm)	REF 164TA3031 (rubber) (400 x 72,5 x 72)



USED FOR
MESSERSI



used for MESSERSI				
TRACK ROLLER	TOP ROLLER	SPROCKET	IDLER	TRACK
				
MESSERSI M16BV				
REF 144TA8507 (for steel tracks) (Ø flange = 100,00 mm) (Ø body = 80,00 mm)		REF 144TA8172 (for rubber tracks) (number of teeth = 21) (number of holes = 9)	REF 144TA8002 (front, with bracket assembly) (for steel tracks)	REF 164TA3044 (rubber) (230 x 96 x 33)
REF 144TA8506 (for rubber tracks) (Ø flange = 116,00 mm) (Ø body = 80,00 mm)		REF 144TA8173 (for steel tracks) (number of teeth = 21) (number of holes = 9)	REF 144TA8001 (front, with bracket assembly) (for rubber tracks) (Ø = 272,00 mm)	
MESSERSI M18BE				
		REF 144TA8679 (for rubber tracks) (number of teeth = 21) (number of holes = 8)		REF 143TA9752 (rubber) (300 x 52,5 x 72)
MESSERSI M22U				
		REF 144TA8175 (for steel tracks) (number of teeth = 21) (number of holes = 9)		REF 143TA9751 (rubber) (260 x 96 x 40)
		REF 144TA8174 (for rubber tracks) (number of teeth = 21) (number of holes = 9)		
MESSERSI M25				
	REF 144TA8312 (assembly) (for steel tracks)	REF 144TA8176 (for steel tracks) (number of teeth = 23) (number of holes = 9)		
MESSERSI M28				
		REF 144TA8178 (for steel tracks) (number of teeth = 23) (number of holes = 9)		REF 164TA9694 (rubber) (300 x 55 x 72)
		REF 144TA8177 (for rubber tracks) (number of teeth = 23) (number of holes = 9)		
MESSERSI M30				
REF 144TA8508 (for rubber tracks) (Ø flange = 108,00 mm) (Ø body = 85,00 mm)	REF 144TA8314 (assembly) (for steel tracks)	REF 144TA8179 (for rubber tracks) (number of teeth = 23) (number of holes = 9)		REF 164TA3025 (rubber) (300 x 55 x 78)
	REF 144TA8313 (assembly) (for rubber tracks)	REF 144TA8180 (for steel tracks) (number of teeth = 23) (number of holes = 9)		
MESSERSI M35				
REF 144TA8509 (for rubber tracks) (Ø flange = 108,00 mm) (Ø body = 85,00 mm)				REF 164TA9691 (rubber) (300 x 55 x 78)
MESSERSI M50P				
REF 144TA8510 (for rubber tracks) (Ø flange = 140,00 mm) (Ø body = 110,00 mm)	REF 144TA8315 (assembly) (for rubber tracks)	REF 144TA1809 (for rubber tracks) (number of teeth = 19) (number of holes = 9)		REF 164TA3032 (rubber) (400 x 72,5 x 72)



USED FOR
mitsubishi

TRACKS & UNDERCARRIAGE PARTS



used for MITSUBISHI

used for MITSUBISHI				
TRACK ROLLER	TOP ROLLER	SPROCKET	IDLER	TRACK
				
MITSUBISHI LD1000				
		REF 144TA8169 (for rubber tracks) (number of teeth = 16) (number of holes = 16)		REF 143TA9934 (rubber) (800 x 150 x 68)
MITSUBISHI MM20				
REF 144TA8511 (for rubber tracks) (∅ flange = 118,00 mm) (∅ body = 94,00 mm)				REF 139TA9620 (rubber) (300 x 52,5 x 74)
MITSUBISHI MM20CR				
REF 144TA8512 (for rubber tracks) (∅ flange = 118,00 mm) (∅ body = 94,00 mm)				REF 139TA9620 (rubber) (300 x 52,5 x 74)
MITSUBISHI MM20SR				
REF 144TA8513 (for rubber tracks) (∅ flange = 118,00 mm) (∅ body = 94,00 mm)				REF 139TA9620 (rubber) (300 x 52,5 x 74)
MITSUBISHI MM20T				
REF 144TA8514 (for rubber tracks) (∅ flange = 118,00 mm) (∅ body = 94,00 mm)				REF 139TA9620 (rubber) (300 x 52,5 x 74)
MITSUBISHI MM25T				
REF 144TA8515 (for rubber tracks) (∅ flange = 118,00 mm) (∅ body = 94,00 mm)				REF 143TA9935 (rubber) (300 x 109 x 39)
MITSUBISHI MM30CR				
REF 144TA8516 (for rubber tracks) (∅ flange = 118,00 mm) (∅ body = 94,00 mm)				REF 143TA9753 (rubber) (300 x 52,5 x 80)
MITSUBISHI MM30SR				
REF 144TA8517 (for rubber tracks) (∅ flange = 118,00 mm) (∅ body = 94,00 mm)				REF 143TA9753 (rubber) (300 x 52,5 x 80)
MITSUBISHI MM35B				
REF 144TA8518 (for rubber tracks) (∅ flange = 118,00 mm) (∅ body = 94,00 mm)	REF 144TA8316 (assembly) (for rubber tracks)			REF 143TA9936 (rubber) (300 x 52,5 x 84)
MITSUBISHI MM35T				
REF 144TA8519 (for rubber tracks) (∅ flange = 118,00 mm) (∅ body = 94,00 mm)				REF 143TA9936 (rubber) (300 x 52,5 x 84)
MITSUBISHI MM40SR				
	REF 144TA8317 (assembly) (for rubber tracks) (∅ body = 80,00 mm)			REF 164TA3058 (rubber) (300 x 52,5 x 84)
MITSUBISHI MM45				
REF 144TA8520 (for rubber tracks) (∅ flange = 134,00 mm) (∅ body = 100,00 mm)				
MITSUBISHI MM45B				
REF 144TA8521 (for rubber tracks) (∅ flange = 134,00 mm) (∅ body = 100,00 mm)				REF 164TA3033 (rubber) (400 x 72,5 x 72)



used for **MITSUBISHI**

TRACK ROLLER	TOP ROLLER	SPROCKET	IDLER	TRACK
				

MITSUBISHI MM57SR

REF 144TA8522

(for rubber tracks) (Ø flange = 134,00 mm)
(Ø body = 100,00 mm)

REF 164TA3033

(rubber) (400 x 72,5 x 72)

MITSUBISHI MS70-8

REF 144TA8318

(assembly) (for steel tracks)
(Ø flange = 105,00 mm)
(Ø body = 85,00 mm)

used for **MITSUBISHI**







USED FOR
MOROOKA



used for MOROOKA				
TRACK ROLLER	TOP ROLLER	SPROCKET	IDLER	TRACK
				
MOROOKA CG100				
REF 144TA8680 (for rubber tracks) (Ø flange = 351,00 mm) (Ø body = 153,00 mm)				
MOROOKA CG110				
REF 144TA8680 (for rubber tracks) (Ø flange = 351,00 mm) (Ø body = 153,00 mm)				
MOROOKA CG60				
REF 144TA8681 (for rubber tracks)				
MOROOKA CG65				
REF 144TA8681 (for rubber tracks)				
MOROOKA CG70				
REF 144TA8680 (for rubber tracks) (Ø flange = 351,00 mm) (Ø body = 153,00 mm)				
MOROOKA MST1000				
REF 144TA8681 (for rubber tracks)				
MOROOKA MST1500				
REF 144TA8523 (for rubber tracks) (Ø flange = 350,00 mm) (Ø body = 126,00 mm)	REF 144TA8319 (assembly) (for rubber tracks) (Ø flange = 232,00 mm)	REF 144TA8181 (for rubber tracks)	REF 144TA8003 (front, with bracket assembly) (for rubber tracks) (Ø = 500,00 mm)	REF 164TA3072 (rubber) (700 x 100 x 98)
MOROOKA MST1500V				
REF 144TA8524 (for rubber tracks) (Ø flange = 350,00 mm) (Ø body = 126,00 mm)	REF 144TA8320 (assembly) (for rubber tracks) (Ø flange = 232,00 mm)	REF 144TA8182 (for rubber tracks) (number of teeth = 20) (number of holes = 16)	REF 144TA8004 (front, with bracket assembly) (for rubber tracks) (Ø = 500,00 mm)	REF 164TA3072 (rubber) (700 x 100 x 98)
MOROOKA MST1500VD				
REF 144TA8525 (for rubber tracks) (Ø flange = 350,00 mm) (Ø body = 126,00 mm)	REF 144TA8321 (assembly) (for rubber tracks) (Ø flange = 232,00 mm)	REF 144TA8183 (for rubber tracks) (number of teeth = 23) (number of holes = 9)	REF 144TA8005 (front, with bracket assembly) (for rubber tracks) (Ø = 500,00 mm)	REF 164TA3072 (rubber) (700 x 100 x 98)
MOROOKA MST1700				
REF 144TA8523 (for rubber tracks) (Ø flange = 350,00 mm) (Ø body = 126,00 mm)	REF 144TA8319 (assembly) (for rubber tracks) (Ø flange = 232,00 mm)			
MOROOKA MST2000				
REF 144TA8526 (for rubber tracks) (Ø flange = 351,00 mm) (Ø body = 153,00 mm)	REF 144TA8684 (assembly) (for rubber tracks) (Ø flange = 232,00 mm)	REF 144TA8184 (for rubber tracks)	REF 144TA8006 (front, with bracket assembly) (for rubber tracks)	REF 143TA9937 (rubber) (800 x 125 x 80)
MOROOKA MST2000V				
REF 144TA8527 (for rubber tracks) (Ø flange = 351,00 mm) (Ø body = 153,00 mm)	REF 144TA8684 (assembly) (for rubber tracks) (Ø flange = 232,00 mm)	REF 144TA8185 (for rubber tracks) (number of teeth = 5) (number of holes = 4)		REF 143TA9937 (rubber) (800 x 125 x 80)
MOROOKA MST2200VD				
REF 144TA8528 (for rubber tracks) (Ø flange = 351,00 mm) (Ø body = 153,00 mm)	REF 144TA8684 (assembly) (for rubber tracks) (Ø flange = 232,00 mm)	REF 144TA8186 (for rubber tracks) (number of teeth = 16) (number of holes = 16)	REF 144TA8007 (front, with bracket assembly) (for rubber tracks)	REF 143TA9938 (rubber) (750 x 150 x 66)



used for MOROOKA				
TRACK ROLLER	TOP ROLLER	SPROCKET	IDLER	TRACK
				
MOROOKA MST2300				
REF 144TA8680 (for rubber tracks) (Ø flange = 351,00 mm) (Ø body = 153,00 mm)	REF 144TA8684 (assembly) (for rubber tracks) (Ø flange = 232,00 mm)			
MOROOKA MST2600				
REF 144TA8680 (for rubber tracks) (Ø flange = 351,00 mm) (Ø body = 153,00 mm)				
MOROOKA MST300VD				
REF 144TA8682 (for rubber tracks)	REF 144TA8683 (assembly) (for rubber tracks)			
MOROOKA MST600				
		REF 144TA8187 (for rubber tracks)		REF 143TA9940 (rubber) (600 x 100 x 80)
MOROOKA MST600V				
		REF 144TA8188 (for rubber tracks)		REF 143TA9939 (rubber) (500 x 90 x 78)
MOROOKA MST600VD				
		REF 144TA8189 (for rubber tracks)		REF 143TA9939 (rubber) (500 x 90 x 78)
MOROOKA MST800				
REF 144TA8681 (for rubber tracks)	REF 144TA8322 (assembly) (for rubber tracks)	REF 144TA8190 (for rubber tracks)		REF 143TA9940 (rubber) (600 x 100 x 80)



USED FOR
NEUSON







used for NEUSON				
TRACK ROLLER	TOP ROLLER	SPROCKET	IDLER	TRACK
				
NEUSON 1101C				
REF 144TA1551 (for rubber tracks) (double guide)		REF 144TA1611 (for rubber tracks)	REF 144TA1640 (front, with bracket assembly) (for rubber tracks) (wide idler)	
REF 144TA1550 (for rubber tracks) (outer guide)			REF 144TA1641 (rear, with bracket assembly) (small idler)	
NEUSON 1101CP				
REF 144TA1551 (for rubber tracks) (double guide)		REF 144TA1611 (for rubber tracks)	REF 144TA1640 (front, with bracket assembly) (for rubber tracks) (wide idler)	
REF 144TA1550 (for rubber tracks) (outer guide)			REF 144TA1641 (rear, with bracket assembly) (small idler)	
NEUSON 1200 RD				
REF 144TA1554 (for rubber tracks) (Ø flange = 130,00 mm) (Ø body = 63,30 mm)		REF 144TA1613 (for rubber tracks)	REF 144TA1577 (front, with bracket assembly) (for rubber tracks)	REF 144TA1679 (rubber) (400 x 72,5w x 74)
NEUSON 12002-01				
<i>S/N: AC-00001 - AC-03528</i>				
REF 144TA1555 (for steel tracks) (Ø flange = 166,00 mm) (Ø body = 137,00 mm)	REF 144TA1584 (assembly) (for rubber and steel tracks)	REF 144TA1598 (for rubber tracks) (number of teeth = 20) (number of holes = 15)	REF 144TA1628 (front, with bracket assembly) (for rubber tracks)	REF 144TA1662 (rubber) (500 x 92w x 78)
REF 143TA8809 (for rubber tracks) (Ø flange = 185,00 mm) (Ø body = 130,00 mm)		REF 144TA1599 (for steel tracks) (number of teeth = 20) (number of holes = 15)	REF 144TA1629 (front, with bracket assembly) (for steel tracks)	
<i>S/N: AC-03529 - and up</i>				
REF 144TA1555 (for steel tracks) (Ø flange = 166,00 mm) (Ø body = 137,00 mm)	REF 143TA8989 (assembly) (for rubber and steel tracks)	REF 144TA1598 (for rubber tracks) (number of teeth = 20) (number of holes = 15)	REF 144TA1628 (front, with bracket assembly) (for rubber tracks)	REF 144TA1662 (rubber) (500 x 92w x 78)
REF 143TA8809 (for rubber tracks) (Ø flange = 185,00 mm) (Ø body = 130,00 mm)		REF 144TA1599 (for steel tracks) (number of teeth = 20) (number of holes = 15)	REF 144TA1629 (front, with bracket assembly) (for steel tracks)	
NEUSON 12002-AA				
REF 144TA1555 (for steel tracks) (Ø flange = 166,00 mm) (Ø body = 137,00 mm)	REF 144TA1584 (assembly) (for rubber and steel tracks)	REF 144TA1599 (for steel tracks) (number of teeth = 20) (number of holes = 15)	REF 144TA1629 (front, with bracket assembly) (for steel tracks)	REF 144TA1662 (rubber) (500 x 92w x 78)
REF 143TA8809 (for rubber tracks) (Ø flange = 185,00 mm) (Ø body = 130,00 mm)		REF 144TA1598 (for rubber tracks) (number of teeth = 20) (number of holes = 15)	REF 144TA1628 (front, with bracket assembly) (for rubber tracks)	
NEUSON 12002-AB				
<i>S/N: AB-00001 - AB-01792</i>				
REF 143TA8809 (for rubber tracks) (Ø flange = 185,00 mm) (Ø body = 130,00 mm)	REF 144TA1584 (assembly) (for rubber and steel tracks)	REF 144TA1598 (for rubber tracks) (number of teeth = 20) (number of holes = 15)	REF 144TA1628 (front, with bracket assembly) (for rubber tracks)	REF 144TA1662 (rubber) (500 x 92w x 78)



used for NEUSON				
TRACK ROLLER	TOP ROLLER	SPROCKET	IDLER	TRACK
				
REF 144TA1555 (for steel tracks) (Ø flange = 166,00 mm) (Ø body = 137,00 mm)		REF 144TA1599 (for steel tracks) (number of teeth = 20) (number of holes = 15)	REF 144TA1629 (front, with bracket assembly) (for steel tracks)	
<i>S/N: AB-01793 - and up</i>				
REF 143TA8809 (for rubber tracks) (Ø flange = 185,00 mm) (Ø body = 130,00 mm)	REF 143TA8989 (assembly) (for rubber and steel tracks)	REF 144TA1598 (for rubber tracks) (number of teeth = 20) (number of holes = 15)	REF 144TA1628 (front, with bracket assembly) (for rubber tracks)	REF 144TA1662 (rubber) (500 x 92w x 78)
REF 144TA1555 (for steel tracks) (Ø flange = 166,00 mm) (Ø body = 137,00 mm)		REF 144TA1599 (for steel tracks) (number of teeth = 20) (number of holes = 15)	REF 144TA1629 (front, with bracket assembly) (for steel tracks)	
NEUSON 1302 RD PRIMUS				
REF 144TA1552 (for rubber tracks) (Ø flange = 130,00 mm) (Ø body = 63,30 mm)		REF 144TA1604 (for rubber tracks) (drive unit type = ctm1016)	REF 144TA1576 (front, with bracket assembly) (for rubber tracks) (without brackets)	REF 144TA1678 (rubber) (230 x 72 x 43)
		REF 144TA1603 (for rubber tracks) (drive unit type = ctd1010)		
NEUSON 1402 RD				
REF 144TA1552 (for rubber tracks) (Ø flange = 130,00 mm) (Ø body = 63,30 mm)		REF 144TA1603 (for rubber tracks) (drive unit type = ctd1010)	REF 144TA1576 (front, with bracket assembly) (for rubber tracks) (without bracket)	REF 144TA1678 (rubber) (230 x 72 x 43)
		REF 144TA1604 (for rubber tracks) (drive unit type = ctm1016)		
NEUSON 1402 RD FORCE				
REF 144TA1553 (for rubber tracks) (Ø flange = 116,00 mm) (Ø body = 80,00 mm)	REF 164TA1446 (guide) (for rubber tracks) (plate type)	REF 144TA1591 (for rubber tracks) (number of teeth = 21) (number of holes = 9)	REF 144TA1622 (front, with bracket assembly) (for steel tracks) (Ø = 236,00 mm)	REF 144TA1660 (rubber) (230 x 96 x 36)
NEUSON 1402 RD PRIMUS-FORCE				
REF 144TA1553 (for rubber tracks) (Ø flange = 116,00 mm) (Ø body = 80,00 mm)	REF 164TA1446 (guide) (for rubber tracks) (plate type)	REF 144TA1591 (for rubber tracks) (number of teeth = 21) (number of holes = 9)	REF 144TA1622 (front, with bracket assembly) (for steel tracks) (Ø = 236,00 mm)	REF 144TA1660 (rubber) (230 x 96 x 36)
NEUSON 1403				
<i>S/N: AB-00440 - and up</i>				
REF 144TA1553 (for rubber tracks) (Ø flange = 116,00 mm) (Ø body = 80,00 mm)		REF 144TA1591 (for rubber tracks) (number of teeth = 21) (number of holes = 9)	REF 144TA1622 (front, with bracket assembly) (for steel tracks) (Ø = 236,00 mm)	REF 144TA1660 (rubber) (230 x 96 x 36)
NEUSON 1403-01				
<i>S/N: AD-00454 - and up</i>				
REF 144TA1553 (for rubber tracks) (Ø flange = 116,00 mm) (Ø body = 80,00 mm)		REF 144TA1591 (for rubber tracks) (number of teeth = 21) (number of holes = 9)	REF 144TA1622 (front, with bracket assembly) (for steel tracks) (Ø = 236,00 mm)	REF 144TA1660 (rubber) (230 x 96 x 36)



used for NEUSON				
TRACK ROLLER	TOP ROLLER	SPROCKET	IDLER	TRACK
				
NEUSON 1403-02				
<i>S/N: AE-00001 - AF-00152</i>				
REF 144TA1553 (for rubber tracks) (Ø flange = 116,00 mm) (Ø body = 80,00 mm)		REF 144TA1591 (for rubber tracks) (number of teeth = 21) (number of holes = 9)	REF 144TA1622 (front, with bracket assembly) (for steel tracks) (Ø = 236,00 mm)	REF 144TA1660 (rubber) (230 x 96 x 36)
NEUSON 1404				
<i>S/N: AF-00761 - and up</i>				
REF 144TA1553 (for rubber tracks) (Ø flange = 116,00 mm) (Ø body = 80,00 mm)				
<i>S/N: AF-00762 - and up</i>				
REF 144TA1553 (for rubber tracks) (Ø flange = 116,00 mm) (Ø body = 80,00 mm)			REF 144TA1578 (front, with bracket assembly) (for rubber tracks) (Ø = 272,00 mm) (fixed chassis)	
<i>S/N: AF-00763 - and up</i>				
REF 144TA1553 (for rubber tracks) (Ø flange = 116,00 mm) (Ø body = 80,00 mm)			REF 144TA1578 (front, with bracket assembly) (for rubber tracks) (Ø = 272,00 mm) (fixed chassis)	REF 144TA1660 (rubber) (230 x 96 x 36)
<i>S/N: AF-00764 - and up</i>				
REF 144TA1553 (for rubber tracks) (Ø flange = 116,00 mm) (Ø body = 80,00 mm)		REF 144TA1591 (for rubber tracks) (number of teeth = 21) (number of holes = 9)	REF 144TA1578 (front, with bracket assembly) (for rubber tracks) (Ø = 272,00 mm) (fixed chassis)	REF 144TA1660 (rubber) (230 x 96 x 36)
<i>S/N: AF-00765 - and up</i>				
REF 144TA1553 (for rubber tracks) (Ø flange = 116,00 mm) (Ø body = 80,00 mm)		REF 144TA1591 (for rubber tracks) (number of teeth = 21) (number of holes = 9)	REF 144TA1622 (front, with bracket assembly) (for rubber tracks) (Ø = 236,00 mm) (extendable chassis) REF 144TA1578 (front, with bracket assembly) (for rubber tracks) (Ø = 272,00 mm) (fixed chassis)	REF 144TA1660 (rubber) (230 x 96 x 36)
NEUSON 14504				
REF 144TA1556 (for rubber and steel tracks) (inner guide)	REF 144TA1586 (assembly) (for rubber and steel tracks)	REF 164TA1519 (for rubber and steel tracks) (number of teeth = 20) (number of holes = 15)	REF 164TA1454 (front, with bracket assembly) (for rubber and steel tracks) (complete with tensioner)	REF 144TA1680 (rubber) (500 x 92 x 84)
REF 144TA1555 (for rubber and steel tracks) (outer guide) (Ø flange = 166,00 mm) (Ø body = 137,00 mm)				
NEUSON 1500				
REF 144TA6772 (for rubber tracks) (Ø flange = 129,50 mm) (Ø body = 68,00 mm)			REF 144TA6704 (front, with bracket assembly) (for rubber tracks) (Ø = 287,00 mm)	REF 143TA9943 (rubber) (230 x 72 x 43)



used for NEUSON				
TRACK ROLLER	TOP ROLLER	SPROCKET	IDLER	TRACK
				
NEUSON 1500 RD				
REF 144TA1554 (for rubber tracks) (Ø flange = 130,00 mm) (Ø body = 63,30 mm)		REF 144TA1612 (for rubber tracks)	REF 144TA1577 (front, with bracket assembly) (for rubber tracks)	REF 144TA1679 (rubber) (400 x 72,5w x 74)
NEUSON 1501 RD				
REF 144TA1554 (for rubber tracks) (Ø flange = 130,00 mm) (Ø body = 63,30 mm)		REF 144TA1613 (for rubber tracks)	REF 144TA1577 (front, with bracket assembly) (for rubber tracks)	REF 144TA1679 (rubber) (400 x 72,5w x 74)
NEUSON 1502 RD				
REF 144TA1552 (for rubber tracks) (Ø flange = 130,00 mm) (Ø body = 63,30 mm)	REF 164TA1442 (guide) (for rubber tracks) (skid type)	REF 144TA1604 (for rubber tracks) (drive unit type = ctm1016) REF 144TA1603 (for rubber tracks) (drive unit type = ctd1010)	REF 144TA1576 (front, with bracket assembly) (for rubber tracks)	REF 144TA1678 (rubber) (230 x 72 x 43)
NEUSON 1502 RD FORCE				
REF 144TA1553 (for rubber tracks) (Ø flange = 116,00 mm) (Ø body = 80,00 mm)	REF 164TA1446 (guide) (for rubber tracks) (plate type)	REF 144TA1591 (for rubber tracks) (number of teeth = 21) (number of holes = 9)	REF 144TA1622 (front, with bracket assembly) (for rubber tracks) (Ø = 236,00 mm)	REF 144TA1660 (rubber) (230 x 96 x 36)
NEUSON 1503				
REF 144TA1553 (for rubber tracks) (Ø flange = 116,00 mm) (Ø body = 80,00 mm) REF 144TA1557 (for steel tracks) (Ø flange = 100,00 mm) (Ø body = 80,00 mm)	REF 164TA1446 (guide) (for rubber and steel tracks) (plate type)	REF 144TA1591 (for rubber tracks) (number of teeth = 21) (number of holes = 9) REF 144TA1607 (for steel tracks) (number of teeth = 19) (number of holes = 9)	REF 144TA1632 (front, with bracket assembly) (for steel tracks) (Ø = 236,00 mm) REF 144TA1622 (front, with bracket assembly) (for rubber tracks) (Ø = 236,00 mm)	REF 144TA1654 (rubber) (230 x 96 x 36)
NEUSON 1503 RD				
REF 144TA6773 (for steel tracks) (Ø flange = 100,00 mm) (Ø body = 80,00 mm) REF 144TA1553 (for rubber tracks) (Ø flange = 116,00 mm) (Ø body = 80,00 mm)		REF 144TA6727 (for steel tracks) (number of teeth = 19) (number of holes = 9) REF 144TA6726 (for rubber tracks) (number of teeth = 21) (number of holes = 9)	REF 144TA1622 (front, with bracket assembly) (for steel tracks) (Ø = 236,00 mm) REF 144TA6705 (front, with bracket assembly) (for rubber tracks) (Ø = 272,00 mm)	REF 164TA3060 (rubber) (230 x 96 x 33)
NEUSON 1503 RD-V				
REF 144TA1553 (for rubber tracks) (Ø flange = 116,00 mm) (Ø body = 80,00 mm) REF 144TA6774 (for steel tracks) (Ø flange = 100,00 mm) (Ø body = 80,00 mm)		REF 144TA6728 (for rubber tracks) (number of teeth = 21) (number of holes = 9) REF 144TA6729 (for steel tracks) (number of teeth = 19) (number of holes = 9)	REF 144TA6706 (front, with bracket assembly) (for rubber tracks) (Ø = 272,00 mm) REF 144TA1622 (front, with bracket assembly) (for steel tracks) (Ø = 236,00 mm)	REF 164TA3060 (rubber) (230 x 96 x 33)
NEUSON 1503-01				
REF 144TA1553 (for rubber tracks) (Ø flange = 116,00 mm) (Ø body = 80,00 mm)		REF 144TA1606 (for steel tracks)	REF 144TA1632 (front, with bracket assembly) (for steel tracks) (Ø = 236,00 mm)	REF 144TA1660 (rubber) (230 x 96 x 36)



used for NEUSON				
TRACK ROLLER	TOP ROLLER	SPROCKET	IDLER	TRACK
				
REF 144TA1557 (for steel tracks) (Ø flange = 100,00 mm) (Ø body = 80,00 mm)		REF 144TA1591 (for rubber tracks) (number of teeth = 21) (number of holes = 9)	REF 144TA1622 (front, with bracket assembly) (for rubber tracks) (Ø = 236,00 mm)	
NEUSON 1503-02				
REF 144TA1553 (for rubber tracks) (Ø flange = 116,00 mm) (Ø body = 80,00 mm)		REF 144TA1591 (for rubber tracks) (number of teeth = 21) (number of holes = 9)	REF 144TA1632 (front, with bracket assembly) (for steel tracks) (Ø = 236,00 mm)	REF 144TA1660 (rubber) (230 x 96 x 36)
REF 144TA1557 (for steel tracks) (Ø flange = 100,00 mm) (Ø body = 80,00 mm)		REF 144TA1606 (for steel tracks)	REF 144TA1622 (front, with bracket assembly) (for rubber tracks) (Ø = 236,00 mm)	
NEUSON 1700 RD				
REF 144TA1554 (for rubber tracks) (Ø flange = 130,00 mm) (Ø body = 63,30 mm)	REF 164TA1452 (assembly) (for rubber tracks) (skid type)	REF 144TA1614 (for rubber tracks)	REF 144TA1577 (front, with bracket assembly) (for rubber tracks)	REF 144TA1681 (rubber) (230 x 72 x 48)
NEUSON 1702 RD				
REF 144TA1552 (for rubber tracks) (Ø flange = 130,00 mm) (Ø body = 63,30 mm)		REF 144TA1615 (for rubber tracks)	REF 144TA1576 (front, with bracket assembly) (for rubber tracks)	REF 144TA1649 (rubber) (230 x 72 x 48)
NEUSON 1703				
<i>S/N: AF-00001 - AF-04765</i>				
REF 144TA1553 (for rubber tracks) (Ø flange = 116,00 mm) (Ø body = 80,00 mm)		REF 144TA1591 (for rubber tracks) (number of teeth = 21) (number of holes = 9)	REF 144TA1622 (front, with bracket assembly) (for rubber tracks) (Ø = 236,00 mm)	REF 144TA1660 (rubber) (230 x 96 x 36)
<i>S/N: AF-04766 - and up</i>				
REF 144TA1553 (for rubber tracks) (Ø flange = 116,00 mm) (Ø body = 80,00 mm)		REF 144TA1616 (for rubber tracks) (number of teeth = 21) (number of holes = 8)	REF 144TA1622 (front, with bracket assembly) (for rubber tracks) (Ø = 236,00 mm)	REF 144TA1660 (rubber) (230 x 96 x 36)
NEUSON 1703VDS				
REF 144TA1553 (for rubber tracks) (Ø flange = 116,00 mm) (Ø body = 80,00 mm)		REF 144TA6730 (for rubber tracks) (number of teeth = 21) (number of holes = 9)	REF 144TA6707 (front, with bracket assembly) (for rubber tracks) (Ø = 272,00 mm)	REF 143TA9945 (rubber) (230 x 96 x 36)
NEUSON 1900 RD				
REF 144TA1554 (for rubber tracks) (Ø flange = 130,00 mm) (Ø body = 63,30 mm)	REF 164TA1452 (assembly) (for rubber tracks)	REF 144TA1614 (for rubber tracks)	REF 144TA1577 (front, with bracket assembly) (for rubber tracks)	REF 144TA1681 (rubber) (230 x 72 x 48)
NEUSON 1901 RD				
REF 144TA1554 (for rubber tracks) (Ø flange = 130,00 mm) (Ø body = 63,30 mm)		REF 144TA1614 (for rubber tracks)	REF 144TA1577 (front, with bracket assembly) (for rubber tracks)	REF 144TA1681 (rubber) (230 x 72 x 48)
NEUSON 1902				
REF 144TA6775 (for steel tracks) (Ø flange = 100,00 mm) (Ø body = 80,00 mm)			REF 144TA6708 (front, with bracket assembly) (for rubber tracks)	REF 143TA9946 (rubber) (230 x 72 x 48)
REF 144TA1553 (for rubber tracks) (Ø flange = 116,00 mm) (Ø body = 80,00 mm)				



used for NEUSON				
TRACK ROLLER	TOP ROLLER	SPROCKET	IDLER	TRACK
				
NEUSON 1902 RD				
REF 144TA1552 (for rubber tracks) (Ø flange = 130,00 mm) (Ø body = 63,30 mm)		REF 144TA1615 (for rubber tracks)	REF 144TA1576 (front, with bracket assembly) (for rubber tracks)	REF 144TA1649 (rubber) (230 x 72 x 48)
NEUSON 1902 RD FORCE				
REF 144TA1553 (for rubber tracks) (Ø flange = 116,00 mm) (Ø body = 80,00 mm)	REF 164TA1446 (guide) (for rubber tracks) (plate type)	REF 144TA1592 (for rubber tracks) (number of teeth = 21) (number of holes = 9)	REF 144TA1622 (front, with bracket assembly) (for steel tracks) (Ø = 236,00 mm)	REF 144TA1654 (rubber) (230 x 96 x 36)
NEUSON 1903				
REF 144TA1553 (for rubber tracks) (Ø flange = 116,00 mm) (Ø body = 80,00 mm)	REF 164TA1446 (guide) (for rubber and steel tracks) (plate type)	REF 144TA1607 (for steel tracks) (number of teeth = 19) (number of holes = 9)	REF 144TA1622 (front, with bracket assembly) (for rubber tracks) (Ø = 236,00 mm)	REF 144TA1653 (rubber) (260 x 96 x 38)
REF 144TA1557 (for steel tracks) (Ø flange = 100,00 mm) (Ø body = 80,00 mm)		REF 144TA1592 (for rubber tracks) (number of teeth = 21) (number of holes = 9)	REF 144TA1632 (front, with bracket assembly) (for steel tracks) (Ø = 236,00 mm)	
NEUSON 1903-01				
REF 144TA1557 (for steel tracks) (Ø flange = 100,00 mm) (Ø body = 80,00 mm)		REF 144TA1607 (for steel tracks) (number of teeth = 19) (number of holes = 9)	REF 144TA1622 (front, with bracket assembly) (for rubber tracks) (Ø = 236,00 mm)	REF 144TA1653 (rubber) (260 x 96 x 38)
REF 144TA1553 (for rubber tracks) (Ø flange = 116,00 mm) (Ø body = 80,00 mm)		REF 144TA1592 (for rubber tracks) (number of teeth = 21) (number of holes = 9)	REF 144TA1632 (front, with bracket assembly) (for steel tracks) (Ø = 236,00 mm)	
NEUSON 1903-02				
REF 144TA1553 (for rubber tracks) (Ø flange = 116,00 mm) (Ø body = 80,00 mm)		REF 144TA1607 (for steel tracks) (number of teeth = 19) (number of holes = 9)	REF 144TA1622 (front, with bracket assembly) (for rubber tracks) (Ø = 236,00 mm)	REF 144TA1653 (rubber) (260 x 96 x 38)
REF 144TA1557 (for steel tracks) (Ø flange = 100,00 mm) (Ø body = 80,00 mm)		REF 144TA1592 (for rubber tracks) (number of teeth = 21) (number of holes = 9)	REF 144TA1632 (front, with bracket assembly) (for steel tracks) (Ø = 236,00 mm)	
NEUSON 2000 RD				
REF 144TA1558 (for rubber tracks)		REF 144TA1600 (for rubber tracks)	REF 144TA1630 (front, with bracket assembly) (for rubber tracks)	REF 144TA1656 (rubber) (230 x 43 x 72)
NEUSON 2003				
REF 144TA1553 (for rubber tracks) (Ø flange = 116,00 mm) (Ø body = 80,00 mm)		REF 144TA1592 (for rubber tracks) (number of teeth = 21) (number of holes = 9)	REF 144TA1622 (front, with bracket assembly) (for steel tracks) (Ø = 236,00 mm)	REF 144TA1653 (rubber) (260 x 96 x 38)
NEUSON 2100 RD				
REF 144TA1558 (for rubber tracks)		REF 144TA1600 (for rubber tracks)	REF 144TA1630 (front, with bracket assembly) (for rubber tracks)	REF 144TA1656 (rubber) (230 x 43 x 72)
NEUSON 2200 RD				
REF 144TA1554 (for rubber tracks) (Ø flange = 130,00 mm) (Ø body = 63,30 mm)	REF 164TA1452 (assembly) (for rubber tracks)	REF 144TA1614 (for rubber tracks)	REF 144TA1577 (front, with bracket assembly) (for rubber tracks)	REF 144TA1681 (rubber) (230 x 72 x 48)



used for NEUSON				
TRACK ROLLER	TOP ROLLER	SPROCKET	IDLER	TRACK
				
NEUSON 2201 RD				
REF 144TA1554 (for rubber tracks) (Ø flange = 130,00 mm) (Ø body = 63,30 mm)		REF 144TA1614 (for rubber tracks)	REF 144TA1577 (front, with bracket assembly) (for rubber tracks)	REF 144TA1681 (rubber) (230 x 72 x 48)
NEUSON 2202				
REF 144TA1553 (for rubber tracks) (Ø flange = 116,00 mm) (Ø body = 80,00 mm)			REF 144TA6709 (front, with bracket assembly) (for rubber tracks) (Ø = 287,00 mm)	REF 143TA9946 (rubber) (230 x 72 x 48)
REF 144TA6776 (for rubber tracks) (Ø flange = 129,50 mm) (Ø body = 68,00 mm)				
REF 144TA6777 (for steel tracks) (Ø flange = 100,00 mm) (Ø body = 80,00 mm)				
NEUSON 2202 RD				
REF 144TA1552 (for rubber tracks) (Ø flange = 130,00 mm) (Ø body = 63,30 mm)	REF 164TA1442 (guide) (for rubber tracks) (skid type)	REF 144TA1615 (for rubber tracks)	REF 144TA1576 (front, with bracket assembly) (for rubber tracks)	REF 144TA1649 (rubber) (230 x 72 x 48)
NEUSON 2202 RD FORCE				
REF 144TA1553 (for rubber tracks) (Ø flange = 116,00 mm) (Ø body = 80,00 mm)		REF 144TA1592 (for rubber tracks) (number of teeth = 21) (number of holes = 9)	REF 144TA1622 (front, with bracket assembly) (for steel tracks) (Ø = 236,00 mm)	REF 144TA1654 (rubber) (230 x 96 x 36)
NEUSON 2203				
REF 144TA1557 (for steel tracks) (Ø flange = 100,00 mm) (Ø body = 80,00 mm)		REF 144TA1607 (for steel tracks) (number of teeth = 19) (number of holes = 9)	REF 144TA1622 (front, with bracket assembly) (for rubber tracks) (Ø = 236,00 mm)	REF 144TA1653 (rubber) (260 x 96 x 38)
REF 144TA1553 (for rubber tracks) (Ø flange = 116,00 mm) (Ø body = 80,00 mm)		REF 144TA1592 (for rubber tracks) (number of teeth = 21) (number of holes = 9)	REF 144TA1632 (front, with bracket assembly) (for steel tracks) (Ø = 236,00 mm)	
NEUSON 2203 RD				
REF 144TA1553 (for rubber tracks) (Ø flange = 116,00 mm) (Ø body = 80,00 mm)			REF 144TA1622 (front, with bracket assembly) (for rubber tracks) (Ø = 236,00 mm)	REF 143TA9948 (rubber) (260 x 96 x 38)
NEUSON 2203-01				
REF 144TA1557 (for steel tracks) (Ø flange = 100,00 mm) (Ø body = 80,00 mm)		REF 144TA1607 (for steel tracks) (number of teeth = 19) (number of holes = 9)	REF 144TA1632 (front, with bracket assembly) (for steel tracks) (Ø = 236,00 mm)	REF 144TA1653 (rubber) (260 x 96 x 38)
REF 144TA1553 (for rubber tracks) (Ø flange = 116,00 mm) (Ø body = 80,00 mm)		REF 144TA1592 (for rubber tracks) (number of teeth = 21) (number of holes = 9)	REF 144TA1622 (front, with bracket assembly) (for rubber tracks) (Ø = 236,00 mm)	
NEUSON 2203-02				
REF 144TA1557 (for steel tracks) (Ø flange = 100,00 mm) (Ø body = 80,00 mm)		REF 144TA1607 (for steel tracks) (number of teeth = 19) (number of holes = 9)	REF 144TA1622 (front, with bracket assembly) (for rubber tracks) (Ø = 236,00 mm)	REF 144TA1653 (rubber) (260 x 96 x 38)



used for NEUSON				
TRACK ROLLER	TOP ROLLER	SPROCKET	IDLER	TRACK
				
REF 144TA1553 (for rubber tracks) (Ø flange = 116,00 mm) (Ø body = 80,00 mm)		REF 144TA1592 (for rubber tracks) (number of teeth = 21) (number of holes = 9)	REF 144TA1632 (front, with bracket assembly) (for steel tracks) (Ø = 236,00 mm)	
NEUSON 2500 RD				
REF 144TA1558 (for rubber tracks)		REF 144TA1600 (for rubber tracks)	REF 144TA1630 (front, with bracket assembly) (for rubber tracks)	REF 144TA1656 (rubber) (230 x 43 x 72)
NEUSON 2500T RD				
REF 144TA1558 (for rubber tracks)		REF 144TA1600 (for rubber tracks)	REF 164TA1453 (front, with bracket assembly) (for rubber tracks) (complete)	REF 144TA1656 (rubber) (230 x 43 x 72)
NEUSON 2503				
REF 164TA1445 (for rubber and steel tracks) (Ø flange = 130,00 mm) (Ø body = 95,00 mm)	REF 144TA1580 (assembly) (for rubber and steel tracks) (Ø flange = 104,00 mm) (Ø body = 80,00 mm)	REF 144TA1593 (for rubber and steel tracks) (number of teeth = 23) (number of holes = 9)	REF 144TA1624 (front, with bracket assembly) (for rubber and steel tracks) (Ø = 338,00 mm)	REF 144TA1652 (rubber) (250 x 109 x 37)
NEUSON 2503 RD				
REF 144TA6779 (for steel tracks) (Ø flange = 119,00 mm) (Ø body = 95,00 mm)	REF 144TA6754 (assembly) (for rubber and steel tracks) (Ø flange = 104,00 mm) (Ø body = 80,00 mm)	REF 144TA6731 (for rubber and steel tracks) (number of teeth = 23) (number of holes = 9)	REF 144TA1624 (front, with bracket assembly) (for rubber and steel tracks) (Ø = 338,00 mm)	REF 143TA9949 (rubber) (300 x 109w x 37)
REF 144TA6778 (for rubber tracks) (Ø flange = 130,00 mm) (Ø body = 95,00 mm)				
NEUSON 2503-01				
REF 164TA1445 (for rubber and steel tracks) (Ø flange = 130,00 mm) (Ø body = 95,00 mm)	REF 144TA1580 (assembly) (for rubber and steel tracks) (Ø flange = 104,00 mm) (Ø body = 80,00 mm)	REF 144TA1593 (for rubber and steel tracks) (number of teeth = 23) (number of holes = 9)	REF 144TA1624 (front, with bracket assembly) (for rubber and steel tracks) (Ø = 338,00 mm)	REF 144TA1669 (rubber) (250 x 109 x 37)
NEUSON 2503-02				
REF 164TA1445 (for rubber and steel tracks) (Ø flange = 130,00 mm) (Ø body = 95,00 mm)	REF 144TA1580 (assembly) (for rubber and steel tracks) (Ø flange = 104,00 mm) (Ø body = 80,00 mm)	REF 144TA1593 (for rubber and steel tracks) (number of teeth = 23) (number of holes = 9)	REF 144TA1624 (front, with bracket assembly) (for rubber and steel tracks) (Ø = 338,00 mm)	REF 144TA1669 (rubber) (250 x 109 x 37)
NEUSON 2503-03 EPA 3				
REF 144TA1559 (for rubber and steel tracks) (Ø flange = 130,00 mm) (Ø body = 95,00 mm)	REF 144TA1580 (assembly) (for rubber and steel tracks) (Ø flange = 104,00 mm) (Ø body = 80,00 mm)	REF 144TA1593 (for rubber and steel tracks) (number of teeth = 23) (number of holes = 9)	REF 144TA1623 (front, with bracket assembly) (for rubber and steel tracks) (Ø = 338,00 mm)	REF 144TA1652 (rubber) (250 x 109 x 37)
NEUSON 2600				
REF 144TA6780 (for rubber tracks) (Ø flange = 124,00 mm) (Ø body = 100,00 mm)			REF 144TA6710 (front, with bracket assembly) (for rubber tracks) (Ø = 295,00 mm)	REF 164TA1400 (rubber) (300 x 52,5 x 74)
NEUSON 2600 RD				
REF 144TA1561 (for rubber tracks)	REF 164TA1457 (assembly) (for rubber tracks) (skid type)	REF 144TA1601 (for rubber tracks) (number of teeth = 21) (number of holes = 9)	REF 144TA1642 (front, with bracket assembly) (for rubber tracks) (complete)	REF 144TA1682 (rubber) (300 x 52,5n x 74)



used for NEUSON				
TRACK ROLLER	TOP ROLLER	SPROCKET	IDLER	TRACK
				
NEUSON 2700 RD				
REF 144TA1558 (for rubber tracks)		REF 144TA1600 (for rubber tracks)	REF 144TA1630 (front, with bracket assembly) (for rubber tracks)	REF 144TA1657 (rubber) (230 x 72 x 43)
NEUSON 2700T RD				
REF 144TA1558 (for rubber tracks)		REF 144TA1600 (for rubber tracks)	REF 164TA1453 (front, with bracket assembly) (for rubber tracks) (complete)	REF 144TA1657 (rubber) (230 x 72 x 43)
NEUSON 2702 RD				
REF 144TA1562 (for rubber tracks) (Ø flange = 124,00 mm) (Ø body = 100,00 mm)	REF 164TA1447 (guide) (for rubber tracks) (skid type)	REF 144TA1602 (for rubber tracks) (number of teeth = 21) (number of holes = 9)	REF 144TA1636 (front, with bracket assembly) (for rubber tracks) (Ø = 295,00 mm)	REF 144TA1663 (rubber) (300 x 52,5 x 74)
NEUSON 2702 RD-FORCE				
REF 144TA1562 (for rubber tracks) (Ø flange = 124,00 mm) (Ø body = 100,00 mm)	REF 164TA1447 (guide) (for rubber tracks) (skid type)	REF 144TA1602 (for rubber tracks) (number of teeth = 21) (number of holes = 9)	REF 144TA1636 (front, with bracket assembly) (for rubber tracks) (Ø = 295,00 mm)	REF 144TA1663 (rubber) (300 x 52,5 x 74)
NEUSON 2702 RD-SLR				
REF 144TA6781 (for rubber tracks) (Ø flange = 124,00 mm) (Ø body = 100,00 mm)		REF 144TA6733 (for rubber tracks) (number of teeth = 21) (number of holes = 9)	REF 144TA6711 (front, with bracket assembly) (for rubber tracks) (Ø = 295,00 mm)	REF 164TA3070 (rubber) (300 x 52,5 x 74)
NEUSON 2800 RD				
REF 144TA1561 (for rubber tracks) (Ø flange = 124,00 mm) (Ø body = 100,00 mm)	REF 164TA1457 (assembly) (for rubber tracks) (skid type)	REF 144TA1601 (for rubber tracks) (number of teeth = 21) (number of holes = 9)	REF 144TA1642 (front, with bracket assembly) (for rubber tracks) (complete)	REF 144TA1682 (rubber) (300 x 52,5n x 74)
NEUSON 28Z				
		REF 144TA6734 (for steel tracks) (number of teeth = 23) (number of holes = 9)		
NEUSON 28Z3				
REF 144TA1559 (for rubber tracks) (Ø flange = 130,00 mm) (Ø body = 95,00 mm)	REF 164TA1451 (assembly) (for rubber tracks) (2nd version) REF 144TA1580 (assembly) (for rubber tracks) (1st version) (Ø flange = 104,00 mm) (Ø body = 80,00 mm)	REF 144TA1593 (for rubber tracks) (number of teeth = 23) (number of holes = 9)	REF 144TA1623 (front, with bracket assembly) (for rubber tracks) (Ø = 338,00 mm)	REF 144TA1651 (rubber) (300 x 52,5 x 82)
NEUSON 2902 RD-FORCE				
REF 144TA1562 (for rubber tracks) (Ø flange = 124,00 mm) (Ø body = 100,00 mm)	REF 164TA1447 (guide) (for rubber tracks) (skid type)	REF 144TA1602 (for rubber tracks) (number of teeth = 21) (number of holes = 9)	REF 144TA1636 (front, with bracket assembly) (for rubber tracks) (Ø = 295,00 mm)	REF 144TA1663 (rubber) (300 x 52,5 x 74)
NEUSON 3000				
REF 144TA6784 (for rubber tracks) (Ø flange = 124,00 mm) (Ø body = 100,00 mm)			REF 144TA6713 (front, with bracket assembly) (for rubber tracks) (Ø = 295,00 mm)	REF 144TA1643 (rubber) (300 x 52,5 x 80)



used for NEUSON				
TRACK ROLLER	TOP ROLLER	SPROCKET	IDLER	TRACK
				
NEUSON 3000 RD				
REF 144TA1561 (for rubber tracks) (Ø flange = 124,00 mm) (Ø body = 100,00 mm)	REF 164TA1457 (assembly) (for rubber tracks)	REF 144TA1601 (for rubber tracks) (number of teeth = 21) (number of holes = 9)	REF 144TA1642 (front, with bracket assembly) (for rubber tracks) (complete)	REF 144TA1643 (rubber) (300 x 52,5 x 80)
NEUSON 3003				
REF 144TA1563 (for steel tracks) (Ø flange = 119,00 mm) (Ø body = 95,00 mm)	REF 144TA1580 (assembly) (for rubber and steel tracks) (Ø flange = 104,00 mm) (Ø body = 80,00 mm)	REF 144TA1593 (for rubber and steel tracks) (number of teeth = 23) (number of holes = 9)	REF 144TA1624 (front, with bracket assembly) (for steel tracks) (Ø = 338,00 mm)	REF 144TA1671 (rubber) (300 x 109w x 38)
REF 144TA1559 (for rubber tracks) (Ø flange = 130,00 mm) (Ø body = 95,00 mm)			REF 144TA1623 (front, with bracket assembly) (for rubber tracks) (Ø = 338,00 mm)	
NEUSON 3003 RD-01				
	REF 144TA6757 (assembly) (for rubber tracks) (Ø flange = 104,00 mm) (Ø body = 80,00 mm)	REF 144TA6736 (for rubber tracks) (number of teeth = 23) (number of holes = 9)		REF 143TA9671 (rubber) (300 x 109 x 38)
NEUSON 3003-01				
REF 144TA1563 (for steel tracks) (Ø flange = 119,00 mm) (Ø body = 95,00 mm)	REF 144TA1580 (assembly) (for rubber and steel tracks) (Ø flange = 104,00 mm) (Ø body = 80,00 mm)	REF 144TA1593 (for rubber and steel tracks) (number of teeth = 23) (number of holes = 9)	REF 144TA1624 (front, with bracket assembly) (for rubber and steel tracks) (Ø = 338,00 mm)	REF 144TA1671 (rubber) (300 x 109w x 38)
REF 164TA1445 (for rubber tracks) (Ø flange = 130,00 mm) (Ø body = 95,00 mm)				
NEUSON 3003-02				
REF 164TA1445 (for rubber tracks) (Ø flange = 130,00 mm) (Ø body = 95,00 mm)	REF 144TA1580 (assembly) (for rubber and steel tracks) (Ø flange = 104,00 mm) (Ø body = 80,00 mm)	REF 144TA1593 (for rubber and steel tracks) (number of teeth = 23) (number of holes = 9)	REF 144TA1624 (front, with bracket assembly) (for rubber and steel tracks) (Ø = 338,00 mm)	REF 144TA1671 (rubber) (300 x 109w x 38)
REF 144TA1563 (for steel tracks) (Ø flange = 119,00 mm) (Ø body = 95,00 mm)				
NEUSON 3200 RD				
REF 144TA1561 (for rubber tracks) (Ø flange = 124,00 mm) (Ø body = 100,00 mm)	REF 164TA1457 (assembly) (for rubber tracks)	REF 144TA1601 (for rubber tracks) (number of teeth = 21) (number of holes = 9)	REF 144TA1642 (front, with bracket assembly) (for rubber tracks) (complete)	REF 144TA1643 (rubber) (300 x 52,5 x 80)
NEUSON 3200 RD-01				
REF 144TA1561 (for rubber tracks) (Ø flange = 124,00 mm) (Ø body = 100,00 mm)		REF 144TA1601 (for rubber tracks) (number of teeth = 21) (number of holes = 9)	REF 144TA1642 (front, with bracket assembly) (for rubber tracks)	
NEUSON 3402 RD				
REF 144TA1562 (for rubber tracks) (Ø flange = 124,00 mm) (Ø body = 100,00 mm)	REF 164TA1447 (guide) (for rubber tracks) (skid type)	REF 144TA1602 (for rubber tracks) (number of teeth = 21) (number of holes = 9)	REF 144TA1636 (front, with bracket assembly) (for rubber tracks) (Ø = 295,00 mm)	REF 144TA1664 (rubber) (320 x 54 x 78)

TRACKS & UNDERCARRIAGE PARTS



used for NEUSON

used for NEUSON				
TRACK ROLLER	TOP ROLLER	SPROCKET	IDLER	TRACK
				
NEUSON 3402 RD-FORCE				
REF 144TA1562 (for rubber tracks) (Ø flange = 124,00 mm) (Ø body = 100,00 mm)	REF 164TA1447 (guide) (for rubber tracks) (skid type)	REF 144TA1602 (for rubber tracks) (number of teeth = 21) (number of holes = 9)	REF 144TA1636 (front, with bracket assembly) (for rubber tracks) (Ø = 295,00 mm)	REF 144TA1664 (rubber) (320 x 54 x 78)
NEUSON 3402-01				
REF 144TA6785 (for rubber tracks) (Ø flange = 124,00 mm) (Ø body = 100,00 mm)		REF 144TA6737 (for rubber tracks) (number of teeth = 21) (number of holes = 9)	REF 144TA6714 (front, with bracket assembly) (for rubber tracks) (Ø = 295,00 mm)	REF 164TA3037 (rubber) (300 x 52,5 x 80)
NEUSON 3503				
REF 144TA1563 (for steel tracks) (Ø flange = 119,00 mm) (Ø body = 95,00 mm)	REF 144TA1580 (assembly) (for rubber and steel tracks) (Ø flange = 104,00 mm) (Ø body = 80,00 mm)	REF 144TA1594 (for rubber and steel tracks) (number of teeth = 23) (number of holes = 9)	REF 144TA1624 (front, with bracket assembly) (for rubber and steel tracks) (Ø = 338,00 mm)	REF 144TA1648 (rubber) (300 x 52,5w x 84)
REF 164TA1445 (for rubber tracks) (Ø flange = 130,00 mm) (Ø body = 95,00 mm)				
NEUSON 3503 RD				
REF 144TA6786 (for rubber tracks) (Ø flange = 130,00 mm) (Ø body = 95,00 mm)	REF 144TA6758 (assembly) (for rubber tracks) (Ø flange = 104,00 mm) (Ø body = 80,00 mm)	REF 144TA6739 (for steel tracks) (number of teeth = 23) (number of holes = 9)	REF 144TA1624 (front, with bracket assembly) (for rubber and steel tracks) (Ø = 338,00 mm)	REF 143TA4263 (rubber) (300 x 109 x 41)
REF 144TA6787 (for steel tracks) (Ø flange = 119,00 mm) (Ø body = 95,00 mm)	REF 144TA6759 (assembly) (for steel tracks) (Ø flange = 104,00 mm) (Ø body = 80,00 mm)	REF 144TA6738 (for rubber tracks) (number of teeth = 23) (number of holes = 9)		
NEUSON 3503-01				
REF 144TA1563 (for steel tracks) (Ø flange = 119,00 mm) (Ø body = 95,00 mm)	REF 144TA1580 (assembly) (for rubber and steel tracks) (Ø flange = 104,00 mm) (Ø body = 80,00 mm)	REF 144TA1594 (for rubber and steel tracks) (number of teeth = 23) (number of holes = 9)	REF 144TA1623 (front, with bracket assembly) (for rubber tracks) (Ø = 338,00 mm)	REF 144TA1648 (rubber) (300 x 52,5w x 84)
REF 144TA1559 (for rubber tracks) (Ø flange = 130,00 mm) (Ø body = 95,00 mm)			REF 144TA1624 (front, with bracket assembly) (for steel tracks) (Ø = 338,00 mm)	
NEUSON 3503-02				
REF 144TA1559 (for rubber tracks) (Ø flange = 130,00 mm) (Ø body = 95,00 mm)	REF 144TA1580 (assembly) (for rubber and steel tracks) (Ø flange = 104,00 mm) (Ø body = 80,00 mm)	REF 144TA1594 (for rubber and steel tracks) (number of teeth = 23) (number of holes = 9)	REF 144TA1623 (front, with bracket assembly) (for rubber tracks) (Ø = 338,00 mm)	REF 144TA1648 (rubber) (300 x 52,5w x 84)
REF 144TA1563 (for steel tracks) (Ø flange = 119,00 mm) (Ø body = 95,00 mm)			REF 144TA1624 (front, with bracket assembly) (for steel tracks) (Ø = 338,00 mm)	
NEUSON 3503-03 EPA 3				
REF 144TA1560 (for steel tracks) (Ø flange = 130,00 mm) (Ø body = 95,00 mm)	REF 144TA1580 (assembly) (for rubber and steel tracks) (Ø flange = 104,00 mm) (Ø body = 80,00 mm)	REF 144TA1594 (for rubber and steel tracks) (number of teeth = 23) (number of holes = 9)	REF 144TA1623 (front, with bracket assembly) (for rubber tracks) (Ø = 338,00 mm)	REF 144TA1658 (rubber) (300 x 52,5w x 84)



used for NEUSON				
TRACK ROLLER	TOP ROLLER	SPROCKET	IDLER	TRACK
				
REF 144TA1559 (for rubber tracks) (Ø flange = 130,00 mm) (Ø body = 95,00 mm)			REF 144TA1624 (front, with bracket assembly) (for steel tracks) (Ø = 338,00 mm)	
NEUSON 3503-04 (VDS)				
REF 144TA1559 (for rubber and steel tracks) (Ø flange = 130,00 mm) (Ø body = 95,00 mm)	REF 144TA1580 (assembly) (for rubber and steel tracks) (Ø flange = 104,00 mm) (Ø body = 80,00 mm)	REF 144TA1594 (for rubber and steel tracks) (number of teeth = 23) (number of holes = 9)	REF 144TA1623 (front, with bracket assembly) (for rubber and steel tracks) (Ø = 338,00 mm)	REF 144TA1658 (rubber) (300 x 52,5w x 84)
NEUSON 3602				
REF 144TA6788 (for rubber tracks) (Ø flange = 124,00 mm) (Ø body = 100,00 mm)			REF 144TA6715 (front, with bracket assembly) (for rubber tracks) (Ø = 295,00 mm)	REF 164TA3080 (rubber) (300 x 109 x 39)
NEUSON 3602 RD				
REF 144TA1561 (for rubber tracks) (Ø flange = 124,00 mm) (Ø body = 100,00 mm)	REF 164TA1457 (assembly) (for rubber tracks) (skid type)	REF 144TA1601 (for rubber tracks) (number of teeth = 21) (number of holes = 9)	REF 144TA1642 (front, with bracket assembly) (for rubber tracks) (complete)	REF 144TA1643 (rubber) (300 x 52,5 x 80)
NEUSON 3602 RD-FORCE				
REF 144TA1562 (for rubber tracks) (Ø flange = 124,00 mm) (Ø body = 100,00 mm)	REF 164TA1447 (guide) (for rubber tracks) (skid type)	REF 144TA1602 (for rubber tracks) (number of teeth = 21) (number of holes = 9)	REF 144TA1636 (front, with bracket assembly) (for rubber tracks) (Ø = 295,00 mm)	REF 144TA1664 (rubber) (320 x 54 x 78)
NEUSON 3602 RDV				
REF 144TA6789 (for rubber tracks) (Ø flange = 124,00 mm) (Ø body = 100,00 mm)		REF 144TA6740 (for rubber tracks) (number of teeth = 21) (number of holes = 9)	REF 144TA6716 (front, with bracket assembly) (for rubber tracks) (Ø = 295,00 mm)	REF 164TA3080 (rubber) (300 x 109 x 39)
NEUSON 3703				
REF 144TA1559 (for rubber tracks) (Ø flange = 130,00 mm) (Ø body = 95,00 mm)	REF 144TA1580 (assembly) (for rubber and steel tracks) (Ø flange = 104,00 mm) (Ø body = 80,00 mm)	REF 144TA1594 (for rubber and steel tracks) (number of teeth = 23) (number of holes = 9)	REF 144TA1623 (front, with bracket assembly) (for rubber and steel tracks) (Ø = 338,00 mm)	REF 144TA1648 (rubber) (300 x 52,5w x 84)
REF 144TA1563 (for steel tracks) (Ø flange = 119,00 mm) (Ø body = 95,00 mm)				
NEUSON 3703 RD				
REF 144TA6790 (for rubber tracks) (Ø flange = 119,00 mm) (Ø body = 95,00 mm)	REF 144TA6760 (assembly) (for rubber tracks) (Ø flange = 104,00 mm) (Ø body = 80,00 mm)	REF 144TA6741 (for rubber tracks) (number of teeth = 23) (number of holes = 9)	REF 144TA6717 (front, with bracket assembly) (for rubber tracks) (Ø = 338,00 mm)	REF 143TA4263 (rubber) (300 x 109 x 41)
NEUSON 3703-01				
REF 144TA1559 (for rubber tracks) (Ø flange = 130,00 mm) (Ø body = 95,00 mm)	REF 144TA1580 (assembly) (for rubber and steel tracks) (Ø flange = 104,00 mm) (Ø body = 80,00 mm)	REF 144TA1594 (for rubber and steel tracks) (number of teeth = 23) (number of holes = 9)	REF 144TA1623 (front, with bracket assembly) (for rubber and steel tracks) (Ø = 338,00 mm)	REF 144TA1648 (rubber) (300 x 52,5w x 84)
REF 144TA1563 (for steel tracks) (Ø flange = 119,00 mm) (Ø body = 95,00 mm)				

TRACKS & UNDERCARRIAGE PARTS



used for NEUSON

used for NEUSON				
TRACK ROLLER	TOP ROLLER	SPROCKET	IDLER	TRACK
				
NEUSON 3703-02				
<p>REF 144TA1563 (for steel tracks) (Ø flange = 119,00 mm) (Ø body = 95,00 mm)</p> <p>REF 164TA1445 (for rubber tracks) (Ø flange = 130,00 mm) (Ø body = 95,00 mm)</p>	<p>REF 144TA1580 (assembly) (for rubber and steel tracks) (Ø flange = 104,00 mm) (Ø body = 80,00 mm)</p>	<p>REF 144TA1594 (for rubber and steel tracks) (number of teeth = 23) (number of holes = 9)</p>	<p>REF 144TA1624 (front, with bracket assembly) (for rubber and steel tracks) (Ø = 338,00 mm)</p>	<p>REF 144TA1648 (rubber) (300 x 52,5w x 84)</p>
NEUSON 3703-03 EPA 3				
<p>REF 144TA1560 (for steel tracks) (Ø flange = 130,00 mm) (Ø body = 95,00 mm)</p> <p>REF 144TA1559 (for rubber tracks) (Ø flange = 130,00 mm) (Ø body = 95,00 mm)</p>	<p>REF 144TA1580 (assembly) (for rubber and steel tracks) (Ø flange = 104,00 mm) (Ø body = 80,00 mm)</p>	<p>REF 144TA1594 (for rubber and steel tracks) (number of teeth = 23) (number of holes = 9)</p>	<p>REF 144TA1623 (front, with bracket assembly) (for rubber and steel tracks) (Ø = 338,00 mm)</p>	<p>REF 144TA1648 (rubber) (300 x 52,5w x 84)</p>
NEUSON 38Z				
		<p>REF 144TA6742 (for steel tracks) (number of teeth = 23) (number of holes = 9)</p>		
NEUSON 38Z3				
<p>REF 144TA1559 (for rubber tracks) (Ø flange = 130,00 mm) (Ø body = 95,00 mm)</p>	<p>REF 144TA1580 (assembly) (for rubber tracks) (Ø flange = 104,00 mm) (Ø body = 80,00 mm)</p>	<p>REF 144TA1594 (for rubber tracks) (number of teeth = 23) (number of holes = 9)</p>	<p>REF 144TA1623 (front, with bracket assembly) (for rubber tracks) (Ø = 338,00 mm)</p>	<p>REF 144TA1648 (rubber) (300 x 52,5w x 84)</p>
NEUSON 38Z3 EPA 3				
<i>S/N: AG-00001 - AG-02026</i>				
<p>REF 144TA1559 (for rubber tracks) (Ø flange = 130,00 mm) (Ø body = 95,00 mm)</p>	<p>REF 144TA1580 (assembly) (for rubber tracks) (Ø flange = 104,00 mm) (Ø body = 80,00 mm)</p>	<p>REF 144TA1594 (for rubber tracks) (number of teeth = 23) (number of holes = 9)</p>	<p>REF 144TA1623 (front, with bracket assembly) (for rubber tracks) (Ø = 338,00 mm)</p>	<p>REF 144TA1648 (rubber) (300 x 52,5w x 84)</p>
<i>S/N: AG-02027 - and up</i>				
<p>REF 144TA1559 (for rubber tracks) (Ø flange = 130,00 mm) (Ø body = 95,00 mm)</p>	<p>REF 144TA1580 (assembly) (for rubber tracks) (Ø flange = 104,00 mm) (Ø body = 80,00 mm)</p>	<p>REF 144TA1617 (for rubber tracks) (number of teeth = 23) (number of holes = 12)</p>	<p>REF 144TA1623 (front, with bracket assembly) (for rubber tracks) (Ø = 338,00 mm)</p>	<p>REF 144TA1648 (rubber) (300 x 52,5w x 84)</p>
NEUSON 5000 RD				
<p>REF 144TA1564 (for steel tracks)</p>	<p>REF 144TA1564 (assembly) (for steel tracks)</p>	<p>REF 144TA1618 (for steel tracks)</p>	<p>REF 144TA1644 (front, with bracket assembly) (for steel tracks) (complete)</p>	
NEUSON 5001 RD				
<p>REF 144TA6794 (for rubber and steel tracks)</p>	<p>REF 144TA6764 (assembly) (for rubber and steel tracks) (Ø flange = 105,00 mm) (Ø body = 35,00 mm)</p>	<p>REF 144TA6743 (for rubber and steel tracks) (number of teeth = 19) (number of holes = 9)</p>	<p>REF 144TA6719 (front, with bracket assembly) (for rubber and steel tracks)</p>	<p>REF 144TA1659 (rubber) (400 x 72,5w x 74)</p>
NEUSON 5001 RD-V				
<p>REF 144TA1565 (for rubber and steel tracks)</p>	<p>REF 144TA1585 (assembly) (for rubber and steel tracks) (Ø body = 105,00 mm)</p>	<p>REF 144TA1589 (for rubber and steel tracks) (number of teeth = 19) (number of holes = 9)</p>	<p>REF 144TA1634 (front, with bracket assembly) (for rubber and steel tracks)</p>	<p>REF 144TA1659 (rubber) (400 x 72,5w x 74)</p>



used for NEUSON				
TRACK ROLLER	TOP ROLLER	SPROCKET	IDLER	TRACK
				
NEUSON 5002				
<i>S/N: AB-00001 - AB-01587</i>				
REF 144TA1566 (for rubber and steel tracks) (Ø flange = 140,00 mm) (Ø body = 110,00 mm)	REF 144TA1585 (assembly) (for rubber and steel tracks) (Ø body = 105,00 mm)	REF 144TA1589 (for rubber and steel tracks) (number of teeth = 19) (number of holes = 9)	REF 144TA1637 (front, with bracket assembly) (for steel tracks) (Ø = 362,00 mm) REF 144TA1631 (front, with bracket assembly) (for rubber tracks) (Ø = 362,00 mm)	REF 144TA1659 (rubber) (400 x 72,5w x 74)
<i>S/N: AB-01588 - and up</i>				
REF 144TA1566 (for rubber and steel tracks) (Ø flange = 140,00 mm) (Ø body = 110,00 mm)	REF 144TA1585 (assembly) (for rubber and steel tracks) (Ø body = 105,00 mm)	REF 144TA1589 (for rubber and steel tracks) (number of teeth = 19) (number of holes = 9)	REF 144TA1625 (front, with bracket assembly) (for steel tracks) (Ø = 362,00 mm) REF 144TA1631 (front, with bracket assembly) (for rubber tracks) (Ø = 362,00 mm)	REF 144TA1659 (rubber) (400 x 72,5w x 74)
NEUSON 5002 RD				
<i>S/N: AA-00001 - AA-00673V</i>				
REF 144TA1566 (for rubber and steel tracks) (Ø flange = 140,00 mm) (Ø body = 110,00 mm)	REF 144TA1585 (assembly) (for rubber and steel tracks) (Ø body = 105,00 mm)	REF 144TA1589 (for rubber and steel tracks) (number of teeth = 19) (number of holes = 9)	REF 144TA1637 (front, with bracket assembly) (for rubber tracks) (Ø = 362,00 mm)	REF 144TA1659 (rubber) (400 x 72,5w x 74)
<i>S/N: AA-00674V - and up</i>				
REF 144TA1566 (for rubber and steel tracks) (Ø flange = 140,00 mm) (Ø body = 110,00 mm)	REF 144TA1585 (assembly) (for rubber and steel tracks) (Ø body = 105,00 mm)	REF 144TA1589 (for rubber and steel tracks) (number of teeth = 19) (number of holes = 9)	REF 144TA1631 (front, with bracket assembly) (for rubber tracks) REF 144TA1637 (front, with bracket assembly) (for steel tracks) (Ø = 362,00 mm)	REF 144TA1659 (rubber) (400 x 72,5w x 74)
NEUSON 50Z				
		REF 144TA6745 (for rubber tracks) (number of teeth = 19) (number of holes = 9)		REF 144TA1659 (rubber) (400 x 72,5w x 74)
NEUSON 50Z3				
REF 144TA1566 (for rubber and steel tracks) (Ø flange = 140,00 mm) (Ø body = 110,00 mm)	REF 144TA1582 (assembly) (for rubber and steel tracks) (Ø body = 80,00 mm)	REF 144TA1589 (for rubber and steel tracks) (number of teeth = 19) (number of holes = 9)	REF 144TA1620 (front, with bracket assembly) (for rubber and steel tracks) (Ø = 362,00 mm)	REF 144TA1659 (rubber) (400 x 72,5w x 74)
NEUSON 50Z3 EPA 3				
<i>S/N: AH-00001 - AH-02665</i>				
REF 144TA1566 (for rubber tracks) (Ø flange = 140,00 mm) (Ø body = 110,00 mm)	REF 144TA1579 (assembly) (for steel tracks) (Ø flange = 104,00 mm) (Ø body = 80,00 mm)	REF 144TA1589 (for rubber and steel tracks) (number of teeth = 19) (number of holes = 9)	REF 144TA1620 (front, with bracket assembly) (for rubber tracks) (Ø = 362,00 mm) REF 144TA1625 (front, with bracket assembly) (for steel tracks) (Ø = 362,00 mm)	REF 144TA1659 (rubber) (400 x 72,5w x 74)



used for NEUSON				
TRACK ROLLER	TOP ROLLER	SPROCKET	IDLER	TRACK
				
<i>S/N: AH-02666 - and up</i>				
REF 144TA1566 (for rubber tracks) (Ø flange = 140,00 mm) (Ø body = 110,00 mm)	REF 144TA1579 (assembly) (for steel tracks) (Ø flange = 104,00 mm) (Ø body = 80,00 mm)	REF 144TA1589 (for rubber and steel tracks) (number of teeth = 19) (number of holes = 9)	REF 144TA1645 (front, with bracket assembly) (for rubber tracks) REF 144TA1625 (front, with bracket assembly) (for steel tracks) (Ø = 362,00 mm)	REF 144TA1659 (rubber) (400 x 72,5w x 74)
NEUSON 50Z3-2 EPA 3				
<i>S/N: AH-00001 - AH-02665</i>				
REF 144TA1566 (for rubber and steel tracks) (Ø flange = 140,00 mm) (Ø body = 110,00 mm)	REF 144TA1579 (assembly) (for rubber and steel tracks) (Ø flange = 104,00 mm) (Ø body = 80,00 mm)	REF 144TA1589 (for rubber and steel tracks) (number of teeth = 19) (number of holes = 9)	REF 144TA1620 (front, with bracket assembly) (for rubber tracks) (Ø = 362,00 mm) REF 144TA1625 (front, with bracket assembly) (for steel tracks) (Ø = 362,00 mm)	REF 144TA1659 (rubber) (400 x 72,5w x 74)
<i>S/N: AH-02666 - and up</i>				
REF 144TA1566 (for rubber and steel tracks) (Ø flange = 140,00 mm) (Ø body = 110,00 mm)	REF 144TA1579 (assembly) (for rubber and steel tracks) (Ø flange = 104,00 mm) (Ø body = 80,00 mm)	REF 144TA1589 (for rubber and steel tracks) (number of teeth = 19) (number of holes = 9)	REF 144TA1645 (front, with bracket assembly) (for rubber tracks) REF 144TA1625 (front, with bracket assembly) (for steel tracks) (Ø = 362,00 mm)	REF 144TA1659 (rubber) (400 x 72,5w x 74)
NEUSON 6002 RD				
<i>S/N: AA-00001 - AA-00673V</i>				
REF 144TA1566 (for rubber and steel tracks) (Ø flange = 140,00 mm) (Ø body = 110,00 mm)	REF 144TA1585 (assembly) (for steel tracks) (Ø body = 105,00 mm)	REF 144TA1589 (for rubber and steel tracks) (number of teeth = 19) (number of holes = 9)	REF 144TA1637 (front, with bracket assembly) (for rubber and steel tracks) (Ø = 362,00 mm)	REF 144TA1659 (rubber) (400 x 72,5w x 74)
<i>S/N: AA-00674V - and up</i>				
REF 144TA1566 (for rubber and steel tracks) (Ø flange = 140,00 mm) (Ø body = 110,00 mm)	REF 144TA1585 (assembly) (for steel tracks) (Ø body = 105,00 mm)	REF 144TA1589 (for rubber and steel tracks) (number of teeth = 19) (number of holes = 9)	REF 144TA1631 (front, with bracket assembly) (for rubber tracks) (Ø = 362,00 mm) REF 144TA1637 (front, with bracket assembly) (for steel tracks) (Ø = 362,00 mm)	REF 144TA1659 (rubber) (400 x 72,5w x 74)
NEUSON 6002-AB				
REF 144TA1566 (for rubber and steel tracks) (Ø flange = 140,00 mm) (Ø body = 110,00 mm)	REF 144TA1585 (assembly) (for rubber and steel tracks) (Ø body = 105,00 mm)	REF 144TA1589 (for rubber and steel tracks) (number of teeth = 19) (number of holes = 9)	REF 144TA1631 (front, with bracket assembly) (for rubber and steel tracks) (Ø = 362,00 mm)	REF 144TA1659 (rubber) (400 x 72,5w x 74)
NEUSON 6003				
REF 144TA1566 (for rubber and steel tracks) (Ø flange = 140,00 mm) (Ø body = 110,00 mm)	REF 144TA1582 (assembly) (for rubber and steel tracks) (Ø body = 80,00 mm)	REF 144TA1589 (for rubber and steel tracks) (number of teeth = 19) (number of holes = 9)	REF 144TA1620 (front, with bracket assembly) (for rubber and steel tracks) (Ø = 362,00 mm)	REF 164TA1448 (rubber) (400 x 72,5w x 74)



used for NEUSON				
TRACK ROLLER	TOP ROLLER	SPROCKET	IDLER	TRACK
				
NEUSON 6003 EPA 3				
REF 144TA1566 (for rubber and steel tracks) (Ø flange = 140,00 mm) (Ø body = 110,00 mm)	REF 144TA1582 (assembly) (for rubber and steel tracks) (Ø body = 80,00 mm)	REF 144TA1589 (for rubber and steel tracks) (number of teeth = 19) (number of holes = 9)	REF 144TA1625 (front, with bracket assembly) (for steel tracks) (Ø = 362,00 mm) REF 144TA1620 (front, with bracket assembly) (for rubber tracks) (Ø = 362,00 mm)	REF 144TA1683 (rubber) (400 x 72,5w x 74)
NEUSON 6003 RD				
REF 144TA6796 (for rubber tracks) (Ø flange = 140,00 mm) (Ø body = 110,00 mm)		REF 144TA6746 (for rubber tracks) (number of teeth = 19) (number of holes = 9)	REF 144TA6722 (front, with bracket assembly) (for rubber tracks) (Ø = 362,00 mm)	REF 144TA1659 (rubber) (400 x 72,5w x 74)
NEUSON 7002 RD				
			REF 144TA6723 (front, with bracket assembly) (for rubber tracks) (Ø = 410,00 mm)	REF 143TA9951 (rubber) (450 x 71 x 84)
NEUSON 7003 RD				
			REF 144TA1627 (front, with bracket assembly) (for steel tracks) (Ø = 410,00 mm)	
NEUSON 75Z				
		REF 144TA6747 (for steel tracks) (number of teeth = 21) (number of holes = 12)		
NEUSON 75Z3				
<i>S/N: AC-00001 - AC-02793</i>				
REF 144TA1568 (for rubber and steel tracks) (outer guide) (Ø flange = 155,00 mm) (Ø body = 121,00 mm)		REF 144TA1609 (for rubber tracks) (number of teeth = 22) (number of holes = 12)		REF 164TA1449 (rubber) (450 x 71 x 86)
REF 144TA1567 (for rubber tracks) (inner guide) (Ø flange = 188,00 mm) (Ø body = 135,00 mm)		REF 144TA1596 (for steel tracks) (number of teeth = 21) (number of holes = 12)		
<i>S/N: AC-00001 - AC-03030</i>				
REF 144TA1568 (for rubber and steel tracks) (outer guide) (Ø flange = 155,00 mm) (Ø body = 121,00 mm)		REF 144TA1596 (for steel tracks) (number of teeth = 21) (number of holes = 12)	REF 144TA1633 (front, with bracket assembly) (for rubber tracks) (Ø = 410,00 mm)	REF 164TA1449 (rubber) (450 x 71 x 86)
REF 144TA1567 (for rubber tracks) (inner guide) (Ø flange = 188,00 mm) (Ø body = 135,00 mm)				
<i>S/N: AC-00001 - AC-03379</i>				
REF 144TA1568 (for rubber and steel tracks) (outer guide) (Ø flange = 155,00 mm) (Ø body = 121,00 mm)	REF 144TA1583 (assembly) (for rubber and steel tracks) (Ø flange = 120,00 mm) (Ø body = 90,70 mm)	REF 144TA1596 (for steel tracks) (number of teeth = 21) (number of holes = 12)		REF 164TA1449 (rubber) (450 x 71 x 86)

TRACKS & UNDERCARRIAGE PARTS



used for NEUSON

used for NEUSON				
TRACK ROLLER	TOP ROLLER	SPROCKET	IDLER	TRACK
				
<p>REF 144TA1567 (for rubber tracks) (inner guide) (Ø flange = 188,00 mm) (Ø body = 135,00 mm) <i>S/N: AC-00001 - AC-03888</i></p>				
<p>REF 144TA1568 (for rubber and steel tracks) (outer guide) (Ø flange = 155,00 mm) (Ø body = 121,00 mm)</p> <p>REF 144TA1567 (for rubber tracks) (inner guide) (Ø flange = 188,00 mm) (Ø body = 135,00 mm) <i>S/N: AC-02794 - and up</i></p>		<p>REF 144TA1596 (for steel tracks) (number of teeth = 21) (number of holes = 12)</p>	<p>REF 144TA1638 (front, with bracket assembly) (for steel tracks) (Ø = 410,00 mm)</p>	<p>REF 164TA1449 (rubber) (450 x 71 x 86)</p>
<p>REF 144TA1568 (for rubber and steel tracks) (outer guide) (Ø flange = 155,00 mm) (Ø body = 121,00 mm)</p> <p>REF 144TA1567 (for rubber tracks) (inner guide) (Ø flange = 188,00 mm) (Ø body = 135,00 mm) <i>S/N: AC-03031 - and up</i></p>		<p>REF 144TA1595 (for rubber tracks) (number of teeth = 22) (number of holes = 12)</p> <p>REF 144TA1596 (for steel tracks) (number of teeth = 21) (number of holes = 12)</p>		<p>REF 164TA1449 (rubber) (450 x 71 x 86)</p>
<p>REF 144TA1568 (for rubber and steel tracks) (outer guide) (Ø flange = 155,00 mm) (Ø body = 121,00 mm)</p> <p>REF 144TA1567 (for rubber tracks) (inner guide) (Ø flange = 188,00 mm) (Ø body = 135,00 mm) <i>S/N: AC-03380 - and up</i></p>		<p>REF 144TA1596 (for steel tracks) (number of teeth = 21) (number of holes = 12)</p>	<p>REF 144TA1626 (front, with bracket assembly) (for rubber tracks) (Ø = 410,00 mm)</p>	<p>REF 164TA1449 (rubber) (450 x 71 x 86)</p>
<p>REF 144TA1568 (for rubber and steel tracks) (outer guide) (Ø flange = 155,00 mm) (Ø body = 121,00 mm)</p> <p>REF 144TA1567 (for rubber tracks) (inner guide) (Ø flange = 188,00 mm) (Ø body = 135,00 mm) <i>S/N: AC-03889 - and up</i></p>	<p>REF 144TA1581 (assembly) (for rubber and steel tracks) (Ø flange = 120,00 mm) (Ø body = 90,70 mm)</p>	<p>REF 144TA1596 (for steel tracks) (number of teeth = 21) (number of holes = 12)</p>		<p>REF 164TA1449 (rubber) (450 x 71 x 86)</p>
<p>REF 144TA1568 (for rubber and steel tracks) (outer guide) (Ø flange = 155,00 mm) (Ø body = 121,00 mm)</p> <p>REF 144TA1567 (for rubber tracks) (inner guide) (Ø flange = 188,00 mm) (Ø body = 135,00 mm)</p>		<p>REF 144TA1596 (for steel tracks) (number of teeth = 21) (number of holes = 12)</p>	<p>REF 144TA1627 (front, with bracket assembly) (for steel tracks) (Ø = 410,00 mm)</p>	<p>REF 164TA1449 (rubber) (450 x 71 x 86)</p>
NEUSON 75Z3 EPA 3				
<p>REF 144TA1568 (for rubber and steel tracks) (outer guide) (Ø flange = 155,00 mm) (Ø body = 121,00 mm)</p> <p>REF 144TA1567 (for rubber tracks) (inner guide) (Ø flange = 188,00 mm) (Ø body = 135,00 mm)</p>	<p>REF 144TA1581 (assembly) (for rubber and steel tracks) (Ø flange = 120,00 mm) (Ø body = 90,70 mm)</p>	<p>REF 144TA1595 (for rubber tracks) (number of teeth = 22) (number of holes = 12)</p> <p>REF 144TA1596 (for steel tracks) (number of teeth = 21) (number of holes = 12)</p>	<p>REF 144TA1626 (front, with bracket assembly) (for rubber tracks) (Ø = 410,00 mm)</p> <p>REF 144TA1627 (front, with bracket assembly) (for steel tracks) (Ø = 410,00 mm)</p>	<p>REF 144TA1684 (rubber) (450 x 71 x 86)</p>



used for NEUSON				
TRACK ROLLER	TOP ROLLER	SPROCKET	IDLER	TRACK
				
NEUSON 75Z3-2				
<p>REF 144TA1567 (for rubber tracks) (inner guide) (Ø flange = 188,00 mm) (Ø body = 135,00 mm)</p> <p>REF 144TA1568 (for rubber and steel tracks) (outer guide) (Ø flange = 155,00 mm) (Ø body = 121,00 mm)</p>	<p>REF 144TA1581 (assembly) (for rubber and steel tracks) (Ø flange = 120,00 mm) (Ø body = 90,70 mm)</p>	<p>REF 144TA1595 (for rubber tracks) (number of teeth = 22) (number of holes = 12)</p> <p>REF 144TA1596 (for steel tracks) (number of teeth = 21) (number of holes = 12)</p>	<p>REF 144TA1627 (front, with bracket assembly) (for steel tracks) (Ø = 410,00 mm)</p> <p>REF 144TA1626 (front, with bracket assembly) (for rubber tracks) (Ø = 410,00 mm)</p>	<p>REF 144TA1684 (rubber) (450 x 71 x 86)</p>
NEUSON 8002				
<p>REF 144TA1567 (for rubber tracks) (inner guide) (Ø flange = 188,00 mm) (Ø body = 135,00 mm)</p> <p>REF 144TA1568 (for rubber and steel tracks) (outer guide) (Ø flange = 155,00 mm) (Ø body = 121,00 mm)</p>	<p>REF 144TA1583 (assembly) (for rubber and steel tracks) (Ø flange = 120,00 mm) (Ø body = 90,70 mm)</p>	<p>REF 144TA1608 (for steel tracks)</p> <p>REF 144TA1597 (for rubber tracks) (number of teeth = 23) (number of holes = 12)</p>	<p>REF 144TA1627 (front, with bracket assembly) (for rubber tracks) (Ø = 410,00 mm)</p> <p>REF 144TA1635 (front, with bracket assembly) (for steel tracks) (Ø = 408,00 mm)</p>	<p>REF 144TA1665 (rubber) (450 x 71 x 84)</p>
NEUSON 8002 RD-AA				
<i>S/N: up to - AB-03184</i>				
<p>REF 144TA1568 (for rubber tracks) (outer guide) (Ø flange = 155,00 mm) (Ø body = 121,00 mm)</p> <p>REF 144TA1567 (for rubber tracks) (inner guide) (Ø flange = 188,00 mm) (Ø body = 135,00 mm)</p>	<p>REF 144TA1583 (assembly) (for rubber tracks) (Ø flange = 120,00 mm) (Ø body = 90,70 mm)</p>	<p>REF 144TA1597 (for rubber tracks) (number of teeth = 23) (number of holes = 12)</p>	<p>REF 144TA1633 (front, with bracket assembly) (for rubber tracks) (Ø = 410,00 mm)</p>	<p>REF 144TA1665 (rubber) (450 x 71 x 84)</p>
<i>S/N: AB-03185 - and up</i>				
<p>REF 144TA1568 (for rubber tracks) (outer guide) (Ø flange = 155,00 mm) (Ø body = 121,00 mm)</p> <p>REF 144TA1567 (for rubber tracks) (inner guide) (Ø flange = 188,00 mm) (Ø body = 135,00 mm)</p>	<p>REF 144TA1583 (assembly) (for rubber tracks) (Ø flange = 120,00 mm) (Ø body = 90,70 mm)</p>	<p>REF 144TA1597 (for rubber tracks) (number of teeth = 23) (number of holes = 12)</p>	<p>REF 144TA1626 (front, with bracket assembly) (for rubber tracks) (Ø = 410,00 mm)</p>	<p>REF 144TA1665 (rubber) (450 x 71 x 84)</p>
NEUSON 8002 RD-AB				
<i>S/N: up to - AB-03184</i>				
<p>REF 144TA1568 (for rubber and steel tracks) (outer guide) (Ø flange = 155,00 mm) (Ø body = 121,00 mm)</p> <p>REF 144TA1567 (for rubber tracks) (inner guide) (Ø flange = 188,00 mm) (Ø body = 135,00 mm)</p>	<p>REF 144TA1583 (assembly) (for rubber and steel tracks) (Ø flange = 120,00 mm) (Ø body = 90,70 mm)</p>	<p>REF 144TA1597 (for rubber tracks) (number of teeth = 23) (number of holes = 12)</p> <p>REF 144TA1608 (for steel tracks)</p>	<p>REF 144TA1633 (front, with bracket assembly) (for rubber tracks) (Ø = 410,00 mm)</p> <p>REF 144TA1635 (front, with bracket assembly) (for steel tracks) (Ø = 408,00 mm)</p>	<p>REF 144TA1665 (rubber) (450 x 71 x 84)</p>
<i>S/N: AB-03185 - and up</i>				
<p>REF 144TA1568 (for rubber and steel tracks) (outer guide) (Ø flange = 155,00 mm) (Ø body = 121,00 mm)</p>	<p>REF 144TA1583 (assembly) (for rubber and steel tracks) (Ø flange = 120,00 mm) (Ø body = 90,70 mm)</p>	<p>REF 144TA1597 (for rubber tracks) (number of teeth = 23) (number of holes = 12)</p>	<p>REF 144TA1626 (front, with bracket assembly) (for rubber tracks) (Ø = 410,00 mm)</p>	<p>REF 144TA1665 (rubber) (450 x 71 x 84)</p>





used for NEUSON				
TRACK ROLLER	TOP ROLLER	SPROCKET	IDLER	TRACK
				
REF 144TA1567 (for rubber tracks) (inner guide) (Ø flange = 188,00 mm) (Ø body = 135,00 mm)		REF 144TA1608 (for steel tracks)	REF 144TA1635 (front, with bracket assembly) (for steel tracks) (Ø = 408,00 mm)	
NEUSON 8002 RD-V				
REF 144TA1567 (for rubber tracks) (inner guide) (Ø flange = 188,00 mm) (Ø body = 135,00 mm)	REF 144TA1583 (assembly) (for rubber and steel tracks) (Ø flange = 120,00 mm) (Ø body = 90,70 mm)	REF 144TA6751 (for steel tracks)	REF 144TA1627 (front, with bracket assembly) (for rubber tracks) (Ø = 410,00 mm)	REF 144TA1665 (rubber) (450 x 71 x 84)
REF 144TA1568 (for rubber and steel tracks) (outer guide) (Ø flange = 155,00 mm) (Ø body = 121,00 mm)		REF 144TA6750 (for rubber tracks) (number of teeth = 23) (number of holes = 12)	REF 144TA1635 (front, with bracket assembly) (for steel tracks) (Ø = 408,00 mm)	
NEUSON 8003				
<i>S/N: AC-00001 - AC-03030</i>				
REF 144TA1568 (for rubber and steel tracks) (outer guide) (Ø flange = 155,00 mm) (Ø body = 121,00 mm)	REF 144TA1583 (assembly) (for rubber and steel tracks) (Ø flange = 120,00 mm) (Ø body = 90,70 mm)	REF 144TA1596 (for rubber and steel tracks) (number of teeth = 21) (number of holes = 12)	REF 144TA1633 (front, with bracket assembly) (for rubber tracks) (Ø = 410,00 mm)	REF 144TA1650 (rubber) (450 x 76k x 80)
REF 144TA1567 (for rubber tracks) (inner guide) (Ø flange = 188,00 mm) (Ø body = 135,00 mm)				
<i>S/N: AC-00001 - AC-03888</i>				
REF 144TA1568 (for rubber and steel tracks) (outer guide) (Ø flange = 155,00 mm) (Ø body = 121,00 mm)	REF 144TA1583 (assembly) (for rubber and steel tracks) (Ø flange = 120,00 mm) (Ø body = 90,70 mm)	REF 144TA1596 (for rubber and steel tracks) (number of teeth = 21) (number of holes = 12)	REF 144TA1638 (front, with bracket assembly) (for steel tracks) (Ø = 410,00 mm)	REF 144TA1650 (rubber) (450 x 76k x 80)
REF 144TA1567 (for rubber tracks) (inner guide) (Ø flange = 188,00 mm) (Ø body = 135,00 mm)				
<i>S/N: AC-03031 - and up</i>				
REF 144TA1568 (for rubber and steel tracks) (outer guide) (Ø flange = 155,00 mm) (Ø body = 121,00 mm)	REF 144TA1583 (assembly) (for rubber and steel tracks) (Ø flange = 120,00 mm) (Ø body = 90,70 mm)	REF 144TA1596 (for rubber and steel tracks) (number of teeth = 21) (number of holes = 12)	REF 144TA1626 (front, with bracket assembly) (for rubber tracks) (Ø = 410,00 mm)	REF 144TA1650 (rubber) (450 x 76k x 80)
REF 144TA1567 (for rubber tracks) (inner guide) (Ø flange = 188,00 mm) (Ø body = 135,00 mm)				
<i>S/N: AC-03889 - and up</i>				
REF 144TA1568 (for rubber and steel tracks) (outer guide) (Ø flange = 155,00 mm) (Ø body = 121,00 mm)	REF 144TA1583 (assembly) (for rubber and steel tracks) (Ø flange = 120,00 mm) (Ø body = 90,70 mm)	REF 144TA1596 (for rubber and steel tracks) (number of teeth = 21) (number of holes = 12)	REF 144TA1627 (front, with bracket assembly) (for steel tracks) (Ø = 410,00 mm)	REF 144TA1650 (rubber) (450 x 76k x 80)
REF 144TA1567 (for rubber tracks) (inner guide) (Ø flange = 188,00 mm) (Ø body = 135,00 mm)				







used for NEUSON				
TRACK ROLLER	TOP ROLLER	SPROCKET	IDLER	TRACK
				
NEUSON 8003 EPA 3				
<p>REF 144TA1567 (for rubber tracks) (inner guide) (Ø flange = 188,00 mm) (Ø body = 135,00 mm)</p> <p>REF 144TA1568 (for rubber and steel tracks) (outer guide) (Ø flange = 155,00 mm) (Ø body = 121,00 mm)</p>	<p>REF 144TA1581 (assembly) (for rubber and steel tracks) (Ø flange = 120,00 mm) (Ø body = 90,70 mm)</p>	<p>REF 144TA1596 (for rubber and steel tracks) (number of teeth = 21) (number of holes = 12)</p>	<p>REF 144TA1626 (front, with bracket assembly) (for rubber tracks) (Ø = 410,00 mm)</p> <p>REF 144TA1627 (front, with bracket assembly) (for steel tracks) (Ø = 410,00 mm)</p>	<p>REF 144TA1650 (rubber) (450 x 76k x 80)</p>
NEUSON 8003-2				
<p>REF 144TA1567 (for rubber tracks) (inner guide) (Ø flange = 188,00 mm) (Ø body = 135,00 mm)</p> <p>REF 144TA1568 (for rubber and steel tracks) (outer guide) (Ø flange = 155,00 mm) (Ø body = 121,00 mm)</p>	<p>REF 144TA1581 (assembly) (for rubber and steel tracks) (Ø flange = 120,00 mm) (Ø body = 90,70 mm)</p>	<p>REF 144TA1596 (for rubber and steel tracks) (number of teeth = 21) (number of holes = 12)</p>	<p>REF 144TA1626 (front, with bracket assembly) (for rubber and steel tracks) (Ø = 410,00 mm)</p>	<p>REF 144TA1686 (rubber) (450 x 76k x 80)</p>
NEUSON 803				
<p>REF 144TA1569 (for rubber tracks) (Ø flange = 120,00 mm) (Ø body = 61,00 mm)</p>		<p>REF 144TA1590 (for rubber tracks)</p>	<p>REF 144TA1621 (front, with bracket assembly) (for rubber tracks)</p>	<p>REF 144TA1661 (rubber) (180 x 72k x 37)</p>
NEUSON ET18				
S/P: E12-02				
<p>REF 164TA1450</p>		<p>REF 144TA1616 (for rubber tracks) (number of teeth = 21) (number of holes = 8)</p> <p>REF 164TA1455 (for rubber tracks) (number of teeth = 21) (number of holes = 9)</p>	<p>REF 164TA1456 (front, with bracket assembly) (for rubber tracks)</p>	<p>REF 164TA1444 (rubber) (230 x 96 x 36)</p>
NEUSON ET18VDS				
				<p>REF 164TA1444 (rubber) (230 x 96 x 36)</p>
NEUSON EZ53VDS				
		<p>REF 164TA1443 (for rubber tracks) (number of teeth = 19) (number of holes = 9)</p>		<p>REF 164TA1401 (rubber) (400 x 72,5 x 74)</p>
NEUSON RK15				
<p>REF 144TA1554 (for rubber tracks) (Ø flange = 130,00 mm) (Ø body = 63,30 mm)</p>		<p>REF 144TA1614 (for rubber tracks)</p>	<p>REF 144TA1577 (front, with bracket assembly) (for rubber tracks)</p>	<p>REF 144TA1681 (rubber) (230 x 72 x 48)</p>
NEUSON RK20S				
<p>REF 144TA1570 (for rubber tracks)</p>	<p>REF 144TA1587 (assembly) (for rubber tracks)</p>	<p>REF 144TA1619 (for rubber tracks)</p>	<p>REF 144TA1647 (front, with bracket assembly) (for rubber tracks)</p>	<p>REF 144TA1687 (rubber) (width = 600,00 mm)</p>
NEUSON TD15				
<p>REF 144TA1573 (for rubber tracks) (for run rocker assembly) (nut mounted)</p> <p>REF 144TA1572 (for rubber tracks) (bolt mounted) (2nd version)</p>	<p>REF 143TA8994 (assembly) (for rubber tracks)</p>	<p>REF 144TA1605 (for rubber tracks)</p>	<p>REF 143TA9528 (front, with bracket assembly) (for rubber tracks)</p>	<p>REF 144TA1666 (rubber) (250 x 72 x 56)</p>



used for NEUSON				
TRACK ROLLER	TOP ROLLER	SPROCKET	IDLER	TRACK
				
<p>REF 144TA1574 (for rubber tracks) (for run rocker assembly) (bolt mounted)</p> <p>REF 144TA1571 (for rubber tracks) (nut mounted) (1st version)</p>				
NEUSON TD15-3S				
<p>REF 144TA1573 (for rubber tracks) (for run rocker assembly) (nut mounted)</p> <p>REF 144TA1571 (for rubber tracks) (nut mounted)</p> <p>REF 144TA1572 (for rubber tracks) (bolt mounted)</p> <p>REF 144TA1574 (for rubber tracks) (for run rocker assembly) (bolt mounted)</p>	<p>REF 143TA8994 (assembly) (for rubber tracks)</p>	<p>REF 144TA1605 (for rubber tracks)</p>	<p>REF 143TA9528 (front, with bracket assembly) (for rubber tracks)</p>	<p>REF 144TA1666 (rubber) (250 x 72 x 56)</p>
NEUSON TD15-H				
<p>REF 144TA1574 (for rubber tracks) (for run rocker assembly) (bolt mounted)</p> <p>REF 144TA1573 (for rubber tracks) (for run rocker assembly) (nut mounted)</p> <p>REF 144TA1572 (for rubber tracks) (bolt mounted)</p> <p>REF 144TA1571 (for rubber tracks) (nut mounted)</p>	<p>REF 143TA8994 (assembly) (for rubber tracks)</p>	<p>REF 144TA1605 (for rubber tracks)</p>	<p>REF 143TA9528 (front, with bracket assembly) (for rubber tracks)</p>	<p>REF 144TA1666 (rubber) (250 x 72 x 56)</p>
NEUSON TD15-H EPA 2				
<p>REF 144TA1574 (nut mounted)</p> <p>REF 144TA1572 (bolt mounted)</p>	<p>REF 144TA1588 (assembly)</p>	<p>REF 144TA1605</p>	<p>REF 143TA9528 (front, with bracket assembly)</p>	<p>REF 144TA1666 (rubber) (250 x 72 x 56)</p>
NEUSON TD18				
<p>REF 144TA1572 (for rubber tracks) (bolt mounted)</p> <p>REF 144TA1571 (for rubber tracks) (nut mounted)</p> <p>REF 144TA1573 (for rubber tracks) (for run rocker assembly) (nut mounted)</p> <p>REF 144TA1574 (for rubber tracks) (for run rocker assembly) (bolt mounted)</p>	<p>REF 144TA1588 (assembly) (for rubber tracks)</p>	<p>REF 144TA1605 (for rubber tracks)</p>	<p>REF 143TA9528 (front, with bracket assembly) (for rubber tracks)</p>	<p>REF 144TA1677 (rubber) (280 x 72 x 56)</p>
NEUSON TD18-3S				
<p>REF 144TA1573 (for rubber tracks) (for run rocker assembly) (nut mounted)</p> <p>REF 144TA1574 (for rubber tracks) (for run rocker assembly) (bolt mounted)</p> <p>REF 144TA1571 (for rubber tracks) (nut mounted)</p>	<p>REF 143TA8994 (assembly) (for rubber tracks)</p>	<p>REF 144TA1605 (for rubber tracks)</p>	<p>REF 143TA9528 (front, with bracket assembly) (for rubber tracks)</p>	<p>REF 144TA1677 (rubber) (280 x 72 x 56)</p>



used for NEUSON				
TRACK ROLLER	TOP ROLLER	SPROCKET	IDLER	TRACK
				
REF 144TA1572 (for rubber tracks) (bolt mounted)				
NEUSON TD18-S				
REF 144TA1573 (for rubber tracks) (for run rocker assembly) (nut mounted) REF 144TA1571 (for rubber tracks) (nut mounted)	REF 143TA8994 (assembly) (for rubber tracks)	REF 144TA1605 (for rubber tracks)	REF 143TA9528 (front, with bracket assembly) (for rubber tracks)	REF 144TA1677 (rubber) (280 x 72 x 56)
NEUSON TD18-S EPA 2				
REF 144TA1574 (for rubber tracks) (for run rocker) (bolt mounted) REF 144TA1572 (for rubber tracks) (bolt mounted)	REF 143TA8994 (assembly) (for rubber tracks)	REF 144TA1605 (for rubber tracks)	REF 143TA9528 (front, with bracket assembly) (for rubber tracks)	REF 144TA1677 (rubber) (280 x 72 x 56)
NEUSON TD9				
REF 144TA1575 (for rubber tracks)		REF 144TA1610 (for rubber tracks)	REF 144TA1639 (front, with bracket assembly) (for rubber tracks)	REF 144TA1676 (rubber) (200 x 72k x 37)
NEUSON TD9D				
REF 144TA1575 (for rubber tracks)		REF 144TA1610 (for rubber tracks)	REF 144TA1639 (front, with bracket assembly) (for rubber tracks)	REF 144TA1676 (rubber) (200 x 72k x 37)
NEUSON TD9P				
REF 144TA1575 (for rubber tracks)		REF 144TA1610 (for rubber tracks)	REF 144TA1639 (front, with bracket assembly) (for rubber tracks)	REF 144TA1676 (rubber) (200 x 72k x 37)



USED FOR
NEW HOLLAND



used for NEW HOLLAND				
TRACK ROLLER	TOP ROLLER	SPROCKET	IDLER	TRACK
				
NEW HOLLAND C175				
REF 164TA2111 (Ø flange = 214,00 mm) (Ø body = 100,00 mm)		REF 163TA9230 (number of teeth = 17) (number of holes = 8)	REF 163TA9234 (front, with bracket assembly) (Ø = 350,00 mm) REF 164TA3091 (rear, with bracket assembly) (Ø = 290,00 mm)	REF 163TA9225 (rubber) (320 x 86 x 50)
NEW HOLLAND C185				
REF 164TA2111 (Ø flange = 214,00 mm) (Ø body = 100,00 mm)		REF 163TA9230 (number of teeth = 17) (number of holes = 8)	REF 164TA2148 (front, with bracket assembly) (Ø = 350,00 mm) REF 164TA3091 (rear, with bracket assembly) (Ø = 290,00 mm)	REF 144TA1023 (rubber) (450 x 55 x 86)
NEW HOLLAND C190				
REF 164TA2111 (Ø flange = 214,00 mm) (Ø body = 100,00 mm)		REF 163TA9230 (number of teeth = 17) (number of holes = 8)	REF 164TA2148 (front, with bracket assembly) (Ø = 350,00 mm) REF 164TA3091 (rear, with bracket assembly) (Ø = 290,00 mm)	REF 144TA1023 (rubber) (450 x 55 x 86)
NEW HOLLAND C227				
REF 164TA2111 (Ø flange = 214,00 mm) (Ø body = 100,00 mm)		REF 163TA9230 (number of teeth = 17) (number of holes = 8)	REF 163TA9235 (front, with bracket assembly) (Ø = 350,00 mm) REF 164TA3091 (rear, with bracket assembly) (Ø = 290,00 mm)	REF 163TA9226 (rubber) (320 x 86 x 50)
NEW HOLLAND C232				
REF 164TA2111 (Ø flange = 214,00 mm) (Ø body = 100,00 mm)		REF 163TA9230 (number of teeth = 17) (number of holes = 8)	REF 163TA9235 (front, with bracket assembly) (Ø = 350,00 mm) REF 164TA3091 (front, with bracket assembly) (Ø = 290,00 mm)	REF 164TA3039 (rubber) (450 x 84 x 56)
NEW HOLLAND C238				
REF 164TA2111 (Ø flange = 214,00 mm) (Ø body = 100,00 mm)		REF 163TA9230 (number of teeth = 17) (number of holes = 8)	REF 163TA9235 (front, with bracket assembly) (Ø = 350,00 mm) REF 164TA3091 (front, with bracket assembly) (Ø = 290,00 mm)	REF 164TA3039 (rubber) (450 x 84 x 56)
NEW HOLLAND E16				
REF 143TA8609 (Ø flange = 114,00 mm) (Ø body = 74,00 mm)		REF 143TA9059 (number of teeth = 19) (number of holes = 9)	REF 143TA9318 (front, with bracket assembly) (Ø = 270,00 mm)	REF 163TA9227 (rubber) (230 x 48 x 70)
NEW HOLLAND E18				
REF 143TA8609 (Ø flange = 114,00 mm) (Ø body = 74,00 mm)		REF 143TA9059 (number of teeth = 19) (number of holes = 9)	REF 143TA9318 (front, with bracket assembly) (Ø = 270,00 mm)	REF 163TA9227 (rubber) (230 x 48 x 70)
NEW HOLLAND E18B				
REF 143TA8609 (Ø flange = 114,00 mm) (Ø body = 74,00 mm)		REF 143TA9059 (number of teeth = 19) (number of holes = 9)	REF 143TA9318 (front, with bracket assembly) (Ø = 270,00 mm)	REF 163TA9227 (rubber) (230 x 48 x 70)



used for NEW HOLLAND				
TRACK ROLLER	TOP ROLLER	SPROCKET	IDLER	TRACK
				
NEW HOLLAND E18SR				
REF 143TA8608		REF 143TA9058 (number of teeth = 19) (number of holes = 9)	REF 143TA9296 (front, with bracket assembly) (Ø = 270,00 mm)	REF 163TA9886 (rubber) (230 x 48 x 70)
NEW HOLLAND E20-2SR				
REF 143TA8611 (Ø flange = 108,00 mm) (Ø body = 85,00 mm)		REF 164TA3019 (number of teeth = 19) (number of holes = 12)	REF 164TA9663 (front, with bracket assembly) (Ø = 271,00 mm)	REF 163TA9228 (rubber) (250 x 52,5 x 76)
NEW HOLLAND E20SR				
REF 163TA9231 (Ø flange = 132,00 mm) (Ø body = 80,00 mm)		REF 143TA9062 (number of teeth = 19) (number of holes = 12)	REF 143TA9320 (front, with bracket assembly)	REF 163TA9887 (rubber) (250 x 52,5 x 76)
NEW HOLLAND E22-2SR				
REF 143TA8611 (Ø flange = 108,00 mm) (Ø body = 85,00 mm)		REF 164TA3019 (number of teeth = 19) (number of holes = 12)	REF 164TA9663 (front, with bracket assembly) (Ø = 271,00 mm)	REF 163TA9228 (rubber) (250 x 52,5 x 76)
NEW HOLLAND E22SR				
REF 163TA9231 (Ø flange = 132,00 mm) (Ø body = 80,00 mm)		REF 143TA9062 (number of teeth = 19) (number of holes = 12)	REF 143TA9320 (front, with bracket assembly)	REF 163TA9887 (rubber) (250 x 52,5 x 76)
NEW HOLLAND E25SR				
REF 163TA9231 (Ø flange = 132,00 mm) (Ø body = 80,00 mm)		REF 143TA9062 (number of teeth = 19) (number of holes = 12)	REF 143TA9320 (front, with bracket assembly)	REF 163TA9228 (rubber) (250 x 52,5 x 76)
NEW HOLLAND E27-2SR				
REF 143TA8611 (Ø flange = 108,00 mm) (Ø body = 85,00 mm)	REF 163TA9232 (assembly) (Ø body = 75,00 mm)	REF 164TA3019 (number of teeth = 19) (number of holes = 12)	REF 164TA9663 (front, with bracket assembly) (Ø = 271,00 mm)	REF 164TA2045 (rubber) (250 x 52,5 x 80)
NEW HOLLAND E27B				
<i>S/N: up to - 50851</i>				
REF 144TA3784 (for rubber tracks) (Ø flange = 108,00 mm) (Ø body = 85,00 mm)	REF 144TA3785 (assembly) (for rubber tracks)	REF 144TA3786 (for rubber tracks) (number of teeth = 19) (number of holes = 12)	REF 144TA3787 (front, with bracket assembly) (for rubber tracks) (Ø = 271,00 mm)	REF 143TA9661 (rubber) (250 x 52,5 x 80)
<i>For all other serial ranges applicable</i>				
	REF 144TA3785 (assembly) (for rubber tracks)	REF 144TA3786 (for rubber tracks) (number of teeth = 19) (number of holes = 12)	REF 144TA3787 (front, with bracket assembly) (for rubber tracks) (Ø = 271,00 mm)	REF 143TA9661 (rubber) (250 x 52,5 x 80)
NEW HOLLAND E30-2SR				
REF 143TA8613 (Ø flange = 108,00 mm) (Ø body = 85,00 mm)	REF 163TA9895 (assembly) (Ø body = 75,00 mm)	REF 143TA9064 (number of teeth = 23) (number of holes = 9)	REF 163TA9898 (front, with bracket assembly)	REF 163TA9440 (rubber) (300 x 52,5 x 82)
NEW HOLLAND E30SR				
REF 163TA9892 (Ø flange = 148,00 mm) (Ø body = 93,00 mm)	REF 163TA9895 (assembly) (Ø body = 75,00 mm)	REF 143TA9063 (number of teeth = 23) (number of holes = 9)	REF 144TA3795 (front, with bracket assembly) (Ø = 345,00 mm)	REF 143TA9663 (rubber) (300 x 52,5 x 82)
NEW HOLLAND E35-2SR				
REF 143TA8613 (Ø flange = 108,00 mm) (Ø body = 85,00 mm)	REF 163TA9895 (assembly) (Ø body = 75,00 mm)	REF 143TA9064 (number of teeth = 23) (number of holes = 9)	REF 163TA9898 (front, with bracket assembly)	REF 163TA9440 (rubber) (300 x 52,5 x 82)





TRACKS & UNDERCARRIAGE PARTS



used for NEW HOLLAND

used for NEW HOLLAND				
TRACK ROLLER	TOP ROLLER	SPROCKET	IDLER	TRACK
				
NEW HOLLAND E35SR				
REF 163TA9892 (Ø flange = 148,00 mm) (Ø body = 93,00 mm)	REF 163TA9895 (assembly) (Ø body = 75,00 mm)	REF 143TA9063 (number of teeth = 23) (number of holes = 9)	REF 144TA3795 (front, with bracket assembly) (Ø = 345,00 mm)	REF 163TA9885 (rubber) (300 x 52,5 x 88)
NEW HOLLAND E39BSR				
REF 144TA3808 (for rubber tracks) (Ø flange = 108,00 mm) (Ø body = 85,00 mm)	REF 144TA3809 (assembly) (for rubber tracks) (Ø body = 75,00 mm)	REF 144TA3810 (for rubber tracks) (number of teeth = 23) (number of holes = 9)	REF 144TA3811 (front, with bracket assembly) (for rubber tracks)	REF 143TA9664 (rubber) (300 x 52,5 x 88)
NEW HOLLAND E40-2SR				
REF 143TA8616 (Ø flange = 130,00 mm) (Ø body = 100,00 mm)	REF 163TA9233 (assembly) (Ø body = 88,00 mm)	REF 163TA9891 (number of teeth = 19) (number of holes = 12)	REF 164TA3066 (front, with bracket assembly) (Ø = 362,00 mm)	REF 164TA3048 (rubber) (400 x 74 x 68)
NEW HOLLAND E40SR				
REF 143TA9384 (Ø flange = 150,00 mm) (Ø body = 94,00 mm)	REF 163TA9233 (assembly) (Ø body = 88,00 mm)	REF 163TA9890 (number of teeth = 19) (number of holes = 12)	REF 143TA9322 (front, with bracket assembly)	REF 164TA3048 (rubber) (400 x 74 x 68)
NEW HOLLAND E45BSR				
REF 143TA8616 (Ø flange = 130,00 mm) (Ø body = 100,00 mm)	REF 163TA9233 (assembly) (Ø body = 88,00 mm)	REF 163TA9891 (number of teeth = 19) (number of holes = 12)	REF 164TA3066 (front, with bracket assembly) (Ø = 362,00 mm)	REF 163TA9888 (rubber) (400 x 74 x 72)
NEW HOLLAND E45SR				
REF 143TA9384 (Ø flange = 150,00 mm) (Ø body = 94,00 mm)	REF 163TA9233 (assembly) (Ø body = 88,00 mm)	REF 163TA9890 (number of teeth = 19) (number of holes = 12)	REF 143TA9322 (front, with bracket assembly)	REF 163TA9888 (rubber) (400 x 74 x 72)
NEW HOLLAND E50				
REF 143TA8616 (Ø flange = 130,00 mm) (Ø body = 100,00 mm)	REF 163TA9233 (assembly) (Ø body = 88,00 mm)	REF 143TA9066 (number of teeth = 19) (number of holes = 12) REF 144TA3828 (number of teeth = 19) (number of holes = 12)	REF 164TA3066 (front, with bracket assembly) (Ø = 362,00 mm)	REF 163TA9888 (rubber) (400 x 74 x 72)
NEW HOLLAND E50-2SR				
REF 143TA8616 (Ø flange = 130,00 mm) (Ø body = 100,00 mm)	REF 163TA9233 (assembly) (Ø body = 88,00 mm)	REF 163TA9891 (number of teeth = 19) (number of holes = 12)	REF 164TA3066 (front, with bracket assembly) (Ø = 362,00 mm)	REF 163TA9229 (rubber) (400 x 74 x 72)
NEW HOLLAND E50SR				
		REF 144TA3830 (for rubber tracks) (number of teeth = 19) (number of holes = 12)		REF 163TA9888 (rubber) (400 x 74 x 72)
NEW HOLLAND E55B				
REF 143TA8616 (Ø flange = 130,00 mm) (Ø body = 100,00 mm)	REF 163TA9233 (assembly) (Ø body = 88,00 mm)	REF 163TA9891 (number of teeth = 19) (number of holes = 12)	REF 164TA3066 (front, with bracket assembly) (Ø = 362,00 mm)	REF 163TA9229 (rubber) (400 x 74 x 72)
NEW HOLLAND E55BX				
REF 144TA3834 (for rubber tracks)	REF 144TA3835 (assembly) (for rubber tracks)	REF 144TA3836 (for rubber tracks) (number of teeth = 19) (number of holes = 12)	REF 144TA3837 (front, with bracket assembly) (for rubber tracks)	REF 143TA9667 (rubber) (400 x 74 x 72)
NEW HOLLAND E70BSR				
REF 163TA9893 (Ø flange = 154,00 mm) (Ø body = 120,00 mm)	REF 163TA9896 (assembly) (Ø body = 82,00 mm)	REF 164TA3086	REF 163TA9517 (front, with bracket assembly)	REF 164TA2046 (rubber) (450 x 81,5 x 76)



used for NEW HOLLAND				
TRACK ROLLER	TOP ROLLER	SPROCKET	IDLER	TRACK
				
NEW HOLLAND E70SR				
REF 163TA9893 (Ø flange = 154,00 mm) (Ø body = 120,00 mm)	REF 163TA9896 (assembly) (Ø body = 82,00 mm)	REF 164TA3086	REF 163TA9517 (front, with bracket assembly)	REF 164TA2046 (rubber) (450 x 81,5 x 76)
NEW HOLLAND E9SR				
REF 163TA9894 (Ø flange = 110,00 mm) (Ø body = 67,70 mm)	REF 163TA9897 (guide) (plate type)	REF 164TA2086	REF 143TA9584 (front, with bracket assembly)	REF 163TA9889 (rubber) (180 x 72 x 40)
NEW HOLLAND FK16MSR				
REF 144TA3858 (for rubber tracks) (Ø flange = 114,00 mm) (Ø body = 74,00 mm)			REF 144TA3859 (front, with bracket assembly) (Ø = 270,00 mm)	
NEW HOLLAND FK18MSR				
REF 144TA3860 (for rubber tracks) (Ø flange = 114,00 mm) (Ø body = 74,00 mm)			REF 144TA3861 (front, with bracket assembly) (Ø = 270,00 mm)	
NEW HOLLAND LT185B				
REF 164TA2111 (Ø flange = 214,00 mm) (Ø body = 100,00 mm)		REF 163TA9230 (number of teeth = 17) (number of holes = 8)	REF 164TA2148 (front, with bracket assembly) (Ø = 350,00 mm) REF 164TA3091 (rear, with bracket assembly) (Ø = 290,00 mm)	REF 164TA3039 (rubber) (450 x 84 x 56)
NEW HOLLAND LT190B				
REF 164TA2111 (Ø flange = 214,00 mm) (Ø body = 100,00 mm)		REF 163TA9230 (number of teeth = 17) (number of holes = 8)	REF 164TA2148 (front, with bracket assembly) (Ø = 350,00 mm) REF 164TA3091 (rear, with bracket assembly) (Ø = 290,00 mm)	REF 164TA3039 (rubber) (450 x 84 x 56)



USED FOR
O&K



used for O&K

used for O&K				
TRACK ROLLER	TOP ROLLER	SPROCKET	IDLER	TRACK
				
O&K RH1.17				
<p>REF 144TA8542 (for steel tracks) (Ø flange = 98,00 mm) (Ø body = 80,00 mm)</p> <p>REF 144TA8541 (for rubber tracks) (Ø flange = 115,00 mm) (Ø body = 80,00 mm)</p>	<p>REF 144TA8324 (assembly) (for steel tracks) (Ø flange = 98,00 mm) (Ø body = 80,00 mm)</p> <p>REF 144TA8323 (assembly) (for rubber tracks) (Ø flange = 115,00 mm) (Ø body = 80,00 mm)</p>	<p>REF 144TA8191 (for rubber tracks) (number of teeth = 19) (number of holes = 8)</p> <p>REF 144TA8192 (for steel tracks) (number of teeth = 19) (number of holes = 8)</p>	<p>REF 144TA8017 (front, with bracket assembly) (for steel tracks) (Ø = 263,00 mm)</p> <p>REF 144TA8016 (front, with bracket assembly) (for rubber tracks)</p>	<p>REF 164TA3045 (rubber) (230 x 96 x 33)</p>
O&K RH1.29				
<p>REF 144TA8544 (for steel tracks) (Ø flange = 115,00 mm) (Ø body = 95,00 mm)</p> <p>REF 144TA8543 (for rubber tracks) (Ø flange = 133,00 mm) (Ø body = 95,00 mm)</p>		<p>REF 144TA8193 (for rubber tracks) (number of teeth = 21) (number of holes = 12)</p> <p>REF 144TA8194 (for steel tracks) (number of teeth = 21) (number of holes = 12)</p>	<p>REF 144TA8019 (front, with bracket assembly) (for steel tracks)</p> <p>REF 144TA8018 (front, with bracket assembly) (for rubber tracks) (Ø = 311,00 mm)</p>	<p>REF 164TA3028 (rubber) (300 x 55 x 72)</p>
O&K RH1.35				
			<p>REF 144TA8020 (front, with bracket assembly) (for rubber tracks) (Ø = 311,00 mm)</p> <p>REF 144TA8021 (front, with bracket assembly) (for steel tracks)</p>	<p>REF 164TA3026 (rubber) (300 x 55 x 78)</p>
O&K RH1.48				
<p>REF 144TA8545 (for rubber tracks) (Ø flange = 140,00 mm) (Ø body = 110,00 mm)</p> <p>REF 144TA8546 (for steel tracks) (Ø flange = 140,00 mm) (Ø body = 110,00 mm)</p>		<p>REF 144TA8195 (for steel tracks)</p> <p>REF 144TA1811 (for rubber tracks) (number of teeth = 19) (number of holes = 9)</p>	<p>REF 144TA8022 (front, with bracket assembly) (for rubber tracks) (Ø = 376,50 mm)</p> <p>REF 144TA8023 (front, with bracket assembly) (for steel tracks) (Ø = 376,50 mm)</p>	<p>REF 164TA3034 (rubber) (400 x 72,5 x 72)</p>
O&K RH2.4(Type1)				
<p>REF 144TA8547 (for rubber tracks)</p>				<p>REF 143TA9954 (rubber) (420 x 100 x 48)</p>
O&K RH2.4(Type2)				
<p>REF 144TA8548 (for rubber tracks)</p>				







USED FOR
PELJOB



used for PELJOB				
TRACK ROLLER	TOP ROLLER	SPROCKET	IDLER	TRACK
				
PELJOB 247				
REF 144TA8437 (for rubber tracks) (Ø flange = 155,00 mm) (Ø body = 121,00 mm)				
PELJOB EB12.4				
REF 144TA7931 (for steel tracks) (Ø flange = 100,00 mm) (Ø body = 80,00 mm)		REF 144TA8141 (for steel tracks)	REF 144TA7963 (front, with bracket assembly) (for rubber tracks) (Ø = 287,00 mm)	REF 163TA9215 (rubber) (230 x 72 x 43)
REF 144TA8453 (for rubber tracks) (Ø flange = 129,50 mm) (Ø body = 68,00 mm)				
PELJOB EB14.4				
REF 144TA8454 (for rubber tracks) (Ø flange = 129,50 mm) (Ø body = 68,00 mm)		REF 144TA8142 (for steel tracks)	REF 144TA7964 (front, with bracket assembly) (for rubber tracks) (Ø = 287,00 mm)	REF 163TA9215 (rubber) (230 x 72 x 43)
REF 144TA7931 (for steel tracks) (Ø flange = 100,00 mm) (Ø body = 80,00 mm)				
PELJOB EB150				
REF 144TA8455 (for rubber tracks) (Ø flange = 116,00 mm) (Ø body = 80,00 mm)		REF 144TA8143 (for rubber tracks) (number of teeth = 21) (number of holes = 9)		REF 164TA3046 (rubber) (230 x 96 x 33)
PELJOB EB150XR				
REF 163TA9218 (Ø flange = 129,50 mm) (Ø body = 68,00 mm)		REF 163TA9217 (number of teeth = 14) (number of holes = 8)	REF 163TA9219 (front, with bracket assembly) (Ø = 287,00 mm)	REF 163TA9215 (rubber) (230 x 72 x 43)
PELJOB EB150XR1				
REF 144TA8456 (for rubber tracks) (Ø flange = 129,50 mm) (Ø body = 68,00 mm)			REF 144TA7965 (front, with bracket assembly) (for rubber tracks) (Ø = 287,00 mm)	REF 163TA9215 (rubber) (230 x 72 x 43)
PELJOB EB150XT				
REF 144TA7931 (for steel tracks) (Ø flange = 100,00 mm) (Ø body = 80,00 mm)		REF 144TA8144 (for rubber tracks) (number of teeth = 21) (number of holes = 9)	REF 144TA7966 (front, with bracket assembly) (for rubber tracks) (Ø = 272,00 mm)	REF 164TA3046 (rubber) (230 x 96 x 33)
REF 144TA8457 (for rubber tracks) (Ø flange = 116,00 mm) (Ø body = 80,00 mm)		REF 144TA8145 (for steel tracks) (number of teeth = 21) (number of holes = 9)	REF 144TA7967 (front, with bracket assembly) (for steel tracks)	
PELJOB EB16.4				
<i>S/N: up to - 19902</i>				
REF 163TA9218 (Ø flange = 129,50 mm) (Ø body = 68,00 mm)		REF 164TA2084 (for rubber tracks)	REF 163TA9219 (front, with bracket assembly) (Ø = 287,00 mm)	REF 163TA9216 (rubber) (250 x 72 x 47)
REF 144TA7931 (for steel tracks) (Ø flange = 100,00 mm) (Ø body = 80,00 mm)				
<i>S/N: 19903 - and up</i>				
REF 163TA9218 (Ø flange = 129,50 mm) (Ø body = 68,00 mm)		REF 164TA2085 (for rubber tracks)	REF 163TA9219 (front, with bracket assembly) (Ø = 287,00 mm)	REF 163TA9216 (rubber) (250 x 72 x 47)







used for PELJOB				
TRACK ROLLER	TOP ROLLER	SPROCKET	IDLER	TRACK
				
REF 144TA7931 (for steel tracks) (Ø flange = 100,00 mm) (Ø body = 80,00 mm)		REF 164TA2084 (for steel tracks)		
PELJOB EB200XT				
REF 144TA7931 (for steel tracks) (Ø flange = 100,00 mm) (Ø body = 80,00 mm)		REF 144TA8146 (for rubber tracks) (number of teeth = 21) (number of holes = 9)	REF 144TA7970 (front, with bracket assembly) (for steel tracks) (Ø = 272,00 mm)	REF 143TA9956 (rubber) (250 x 96 x 36)
REF 144TA8459 (for rubber tracks) (Ø flange = 116,00 mm) (Ø body = 80,00 mm)		REF 144TA8147 (for steel tracks) (number of teeth = 21) (number of holes = 9)	REF 144TA7969 (front, with bracket assembly) (for rubber tracks) (Ø = 272,00 mm)	
PELJOB EB200XTV				
REF 144TA8460 (for rubber tracks) (Ø flange = 116,00 mm) (Ø body = 80,00 mm)		REF 144TA8148 (for rubber tracks) (number of teeth = 21) (number of holes = 9)	REF 144TA7971 (front, with bracket assembly) (for rubber tracks) (Ø = 272,00 mm)	REF 143TA9956 (rubber) (250 x 96 x 36)
REF 144TA7931 (for steel tracks) (Ø flange = 100,00 mm) (Ø body = 80,00 mm)		REF 144TA8149 (for steel tracks) (number of teeth = 21) (number of holes = 9)	REF 144TA7972 (front, with bracket assembly) (for steel tracks) (Ø = 272,00 mm)	
PELJOB EB22XR				
		REF 144TA8150 (for rubber tracks) (number of teeth = 12) (number of holes = 8)		REF 143TA9957 (rubber) (320 x 100 x 38)
PELJOB EB25.4XR-1				
REF 144TA8461 (for rubber tracks) (Ø flange = 127,00 mm) (Ø body = 100,00 mm)				REF 143TA9958 (rubber) (300 x 109 x 35)
PELJOB EB250				
REF 144TA8462 (for rubber tracks) (Ø flange = 130,00 mm) (Ø body = 95,00 mm)				REF 143TA9683 (rubber) (300 x 109 x 38)
PELJOB EB250XT				
REF 144TA8463 (for rubber tracks) (Ø flange = 130,00 mm) (Ø body = 95,00 mm)	REF 144TA8300 (assembly) (for rubber tracks) (Ø flange = 104,00 mm) (Ø body = 80,00 mm)	REF 144TA8151 (for rubber tracks) (number of teeth = 23) (number of holes = 9)	REF 144TA7973 (front, with bracket assembly) (for rubber tracks) (Ø = 338,00 mm)	REF 143TA9683 (rubber) (300 x 109 x 38)
PELJOB EB30.4				
REF 163TA9435 (for rubber tracks) (1st type) (Ø flange = 115,00 mm) (Ø body = 94,00 mm)				REF 143TA9958 (rubber) (300 x 109 x 35)
REF 163TA9436 (for rubber tracks) (2nd type) (Ø flange = 127,00 mm) (Ø body = 100,00 mm)				
PELJOB EB300XT				
REF 144TA8465 (for rubber tracks) (Ø flange = 115,00 mm) (Ø body = 94,00 mm)	REF 144TA8301 (assembly) (for rubber tracks) (Ø flange = 104,00 mm) (Ø body = 80,00 mm)	REF 144TA8152 (for rubber tracks) (number of teeth = 23) (number of holes = 9)		REF 164TA3054 (rubber) (300 x 109 x 38)



used for PELJOB				
TRACK ROLLER	TOP ROLLER	SPROCKET	IDLER	TRACK
				
PELJOB EB306				
<p>REF 163TA9435 (for rubber tracks) (1st type) (Ø flange = 115,00 mm) (Ø body = 94,00 mm)</p> <p>REF 163TA9436 (for rubber tracks) (2nd type) (Ø flange = 127,00 mm) (Ø body = 100,00 mm)</p>	<p>REF 144TA8302 (assembly) (for rubber tracks) (Ø flange = 104,00 mm) (Ø body = 80,00 mm)</p>			<p>REF 143TA9905 (rubber) (300 x 109 x 41)</p>
PELJOB EB350XT				
<p>REF 144TA8468 (for rubber tracks) (Ø flange = 115,00 mm) (Ø body = 94,00 mm)</p>	<p>REF 144TA8303 (assembly) (for rubber tracks) (Ø flange = 104,00 mm) (Ø body = 80,00 mm)</p>	<p>REF 144TA8153 (for rubber tracks) (number of teeth = 23) (number of holes = 12)</p>		<p>REF 143TA9905 (rubber) (300 x 109 x 41)</p>
PELJOB EB36				
<p>REF 144TA8469 (for rubber tracks) (Ø flange = 115,00 mm) (Ø body = 94,00 mm)</p>				<p>REF 143TA9905 (rubber) (300 x 109 x 41)</p>
PELJOB EB406				
<p>REF 163TA9435 (for rubber tracks) (1st type) (Ø flange = 115,00 mm) (Ø body = 94,00 mm)</p> <p>REF 163TA9436 (for rubber tracks) (2nd type) (Ø flange = 127,00 mm) (Ø body = 100,00 mm)</p>		<p>REF 144TA8154 (for rubber tracks)</p>		<p>REF 143TA9905 (rubber) (300 x 109 x 41)</p>
PELJOB EB450XT				
<p>REF 144TA8471 (for rubber tracks) (Ø flange = 140,00 mm) (Ø body = 110,00 mm)</p>		<p>REF 144TA1812 (for rubber tracks) (number of teeth = 19) (number of holes = 9)</p>		<p>REF 143TA9959 (rubber) (400 x 72,5 x 68)</p>
PELJOB EB506				
<p>REF 144TA8473 (for rubber tracks) (outer guide) (Ø flange = 155,00 mm) (Ø body = 121,00 mm)</p> <p>REF 144TA8474 (for steel tracks) (outer guide) (Ø flange = 155,00 mm) (Ø body = 121,00 mm)</p> <p>REF 144TA8472 (for rubber tracks) (inner guide) (Ø flange = 188,00 mm) (Ø body = 135,00 mm)</p>			<p>REF 144TA7974 (front, with bracket assembly) (for rubber tracks) (Ø = 408,00 mm)</p> <p>REF 144TA7975 (front, with bracket assembly) (for steel tracks) (Ø = 408,00 mm)</p>	<p>REF 143TA9960 (rubber) (400 x 72,5 x 70)</p>
PELJOB EB706C				
<p>REF 144TA8475 (for rubber tracks) (outer guide) (Ø flange = 188,00 mm) (Ø body = 135,00 mm)</p> <p>REF 144TA8477 (for steel tracks) (outer guide) (Ø flange = 155,00 mm) (Ø body = 121,00 mm)</p> <p>REF 144TA8476 (for rubber tracks) (inner guide) (Ø flange = 155,00 mm) (Ø body = 121,00 mm)</p>	<p>REF 144TA8305 (assembly) (for steel tracks) (Ø flange = 120,00 mm) (Ø body = 90,70 mm)</p> <p>REF 144TA8304 (assembly) (for rubber tracks) (Ø flange = 120,00 mm) (Ø body = 90,70 mm)</p>	<p>REF 144TA8155 (for steel tracks)</p>	<p>REF 144TA7976 (front, with bracket assembly) (for rubber tracks) (Ø = 410,00 mm)</p> <p>REF 144TA7977 (front, with bracket assembly) (for steel tracks) (Ø = 408,00 mm)</p>	<p>REF 143TA9961 (rubber) (450 x 71 x 80)</p>



used for PELJOB				
TRACK ROLLER	TOP ROLLER	SPROCKET	IDLER	TRACK
				
PELJOB LS286				
REF 144TA8504 (for rubber tracks) (∅ flange = 119,00 mm) (∅ body = 95,00 mm)	REF 144TA8310 (assembly) (for rubber tracks) (∅ flange = 104,00 mm) (∅ body = 80,00 mm)	REF 144TA8170 (for rubber tracks)		REF 143TA9905 (rubber) (300 x 109 x 41)
PELJOB LS386				
REF 144TA8505 (for rubber tracks) (∅ flange = 115,00 mm) (∅ body = 94,00 mm)	REF 144TA8311 (assembly) (for rubber tracks) (∅ flange = 104,00 mm) (∅ body = 80,00 mm)	REF 144TA8171 (for rubber tracks) (number of teeth = 23) (number of holes = 12)	REF 144TA8000 (front, with bracket assembly) (for rubber tracks) (∅ = 338,00 mm)	REF 143TA9905 (rubber) (300 x 109 x 41)
PELJOB SIRIUS+				
REF 144TA8419 (for rubber tracks) (∅ flange = 129,50 mm) (∅ body = 68,00 mm)		REF 144TA7932 (for rubber tracks) (number of teeth = 14) (number of holes = 8)	REF 143TA9522 (front, with bracket assembly) (for rubber tracks) (∅ = 287,00 mm)	REF 163TA9215 (rubber) (230 x 72 x 43)
PELJOB SIRIUS271				
REF 144TA8554 (for rubber tracks) (∅ flange = 129,50 mm) (∅ body = 68,00 mm)		REF 144TA7932 (for rubber tracks) (number of teeth = 14) (number of holes = 8)	REF 144TA8026 (front, with bracket assembly) (for rubber tracks) (∅ = 287,00 mm)	REF 163TA9215 (rubber) (230 x 72 x 43)



USED FOR
SHAEFF





used for SHAEFF				
TRACK ROLLER	TOP ROLLER	SPROCKET	IDLER	TRACK
				
SHAEFF HR 02			REF 144TA7978 (wheel only) (for rubber tracks)	REF 164TA3059 (rubber) (230 x 96 x 33)
SHAEFF HR 1.6			REF 144TA9764 (wheel only) (for rubber tracks)	REF 143TA9617 (rubber) (230 x 48 x 66)
SHAEFF HR 11		REF 144TA8156 (for rubber tracks) (number of teeth = 19) (number of holes = 8) (total height = 23,40 mm)	REF 144TA7979 (wheel only) (for rubber tracks)	REF 164TA3059 (rubber) (230 x 96 x 33)
SHAEFF HR 12				
REF 144TA8478 (for rubber tracks) (Ø flange = 115,00 mm) (Ø body = 80,00 mm)	REF 144TA8306 (assembly) (for rubber tracks) (Ø flange = 115,00 mm) (Ø body = 80,00 mm)	REF 144TA8157 (for rubber tracks) (number of teeth = 19) (number of holes = 8) (total height = 23,40 mm)	REF 144TA9777 (wheel only) (for rubber tracks)	REF 143TA9617 (rubber) (230 x 48 x 66)
REF 144TA8479 (for steel tracks) (Ø flange = 98,00 mm) (Ø body = 80,00 mm)	REF 144TA8307 (assembly) (for steel tracks) (Ø flange = 98,00 mm) (Ø body = 80,00 mm)	REF 144TA8158 (for steel tracks) (number of teeth = 19) (number of holes = 8) (total height = 23,40 mm)	REF 144TA7980 (wheel only) (for rubber tracks) (Ø = 264,50 mm)	REF 164TA3059 (rubber) (230 x 96 x 33)
			REF 144TA7981 (wheel only) (for steel tracks) (Ø = 264,50 mm)	
SHAEFF HR 13				
REF 144TA8480 (for rubber tracks) (Ø flange = 115,00 mm) (Ø body = 80,00 mm)	REF 144TA8308 (assembly) (for rubber tracks) (Ø flange = 115,00 mm) (Ø body = 80,00 mm)	REF 144TA8159 (for rubber tracks) (number of teeth = 19) (number of holes = 8) (total height = 23,40 mm)	REF 144TA7982 (wheel only) (for rubber tracks)	REF 164TA3059 (rubber) (230 x 96 x 33)
REF 144TA8481 (for steel tracks) (Ø flange = 98,00 mm) (Ø body = 80,00 mm)	REF 144TA8309 (assembly) (for steel tracks) (Ø flange = 98,00 mm) (Ø body = 80,00 mm)	REF 144TA8160 (for steel tracks) (number of teeth = 19) (number of holes = 8) (total height = 23,40 mm)	REF 144TA7983 (wheel only) (for steel tracks)	
SHAEFF HR 14				
REF 144TA9778 (for rubber tracks) (Ø flange = 133,00 mm) (Ø body = 95,00 mm)		REF 144TA9779 (for rubber tracks) (number of teeth = 21) (number of holes = 12) (total height = 26,00 mm)	REF 144TA9780 (wheel only) (for rubber tracks) (Ø = 311,00 mm)	REF 164TA3027 (rubber) (300 x 55 x 72)
REF 144TA9781 (for steel tracks) (Ø flange = 115,00 mm) (Ø body = 95,00 mm)		REF 144TA9782 (for steel tracks) (number of teeth = 21) (number of holes = 12) (total height = 26,00 mm)	REF 144TA9783 (wheel only) (for steel tracks)	REF 164TA9688 (rubber) (300 x 109 x 36)
REF 144TA8482 (for rubber tracks) (Ø flange = 115,00 mm) (Ø body = 95,00 mm)		REF 144TA8675 (for rubber and steel tracks) (number of teeth = 21) (number of holes = 12) (total height = 26,00 mm)	REF 144TA7984 (wheel only) (for rubber tracks) (Ø = 311,00 mm)	
REF 144TA8484 (for steel tracks) (Ø flange = 115,00mm) (Ø body = 95,00 mm)			REF 144TA7985 (wheel only) (for steel tracks)	
REF 144TA8483 (for rubber tracks) (Ø flange = 133,00 mm) (Ø body = 95,00 mm)				



used for SHAEFF				
TRACK ROLLER	TOP ROLLER	SPROCKET	IDLER	TRACK
				
SHAEFF HR 16				
<p>REF 144TA9784 (for rubber tracks) (Ø flange = 133,00 mm) (Ø body = 95,00 mm)</p> <p>REF 144TA9786 (for steel tracks) (Ø flange = 115,00 mm) (Ø body = 95,00 mm)</p> <p>REF 144TA8485 (for rubber tracks) (Ø flange = 133,00 mm) (Ø body = 95,00 mm)</p> <p>REF 144TA8486 (for steel tracks) (Ø flange = 115,00mm)(Ø body = 95,00 mm)</p>		<p>REF 144TA9785 (for rubber tracks) (number of teeth = 21) (number of holes = 12) (total height = 26,00 mm)</p> <p>REF 144TA9787 (for steel tracks) (number of teeth = 21) (number of holes = 12) (total height = 26,00 mm)</p> <p>REF 144TA8675 (for rubber and steel tracks) (number of teeth = 21) (number of holes = 12) (total height = 26,00 mm)</p>	<p>REF 144TA9764 (wheel only) (for rubber tracks)</p> <p>REF 144TA9788 (wheel only) (for steel tracks)</p> <p>REF 144TA7986 (wheel only) (for rubber tracks) (Ø = 311,00 mm)</p> <p>REF 144TA7987 (wheel only) (for steel tracks)</p>	<p>REF 143TA9613 (rubber) (300 x 55 x 78)</p> <p>REF 164TA9689 (rubber) (300 x 109 x 39)</p>
SHAEFF HR 18				
<p>REF 144TA8487 (for rubber tracks) (Ø flange = 140,00 mm) (Ø body = 110,00 mm)</p> <p>REF 144TA8488 (for steel tracks) (Ø flange = 140,00 mm) (Ø body = 110,00 mm)</p>		<p>REF 144TA8161 (for rubber tracks)</p> <p>REF 144TA8162 (for steel tracks)</p>	<p>REF 144TA7988 (wheel only) (for rubber tracks) (Ø = 376,50 mm)</p> <p>REF 144TA7989 (wheel only) (for steel tracks) (Ø = 376,50 mm)</p>	<p>REF 143TA9778 (rubber) (400 x 72,5 x 72)</p>
SHAEFF HR 2.0				
	<p>REF 144TA9765 (assembly) (for rubber tracks) (Ø flange = 115,00 mm) (Ø body = 80,00 mm)</p> <p>REF 144TA9768 (assembly) (for steel tracks) (Ø flange = 98,00 mm) (Ø body = 80,00 mm)</p>	<p>REF 144TA9766 (for rubber tracks) (number of teeth = 19) (number of holes = 8) (total height = 23,40 mm)</p> <p>REF 144TA9769 (for steel tracks) (number of teeth = 19) (number of holes = 8) (total height = 23,40 mm)</p>	<p>REF 144TA9767 (wheel only) (for rubber tracks)</p> <p>REF 144TA9770 (wheel only) (for steel tracks)</p>	<p>REF 143TA9617 (rubber) (230 x 48 x 66)</p>
SHAEFF HR 20				
<p>REF 144TA8489 (for rubber tracks) (Ø flange = 140,00 mm) (Ø body = 110,00 mm)</p> <p>REF 144TA8490 (for steel tracks) (Ø flange = 140,00 mm) (Ø body = 110,00 mm)</p>		<p>REF 144TA8163 (for rubber tracks)</p> <p>REF 144TA8164 (for steel tracks)</p>	<p>REF 144TA7990 (wheel only) (for rubber tracks) (Ø = 376,50 mm)</p> <p>REF 144TA7991 (wheel only) (for steel tracks) (Ø = 376,50 mm)</p>	<p>REF 143TA9694 (rubber) (400 x 72,5 x 72)</p>
SHAEFF HR 21				
<p>REF 144TA8491 (for rubber tracks) (Ø flange = 140,00 mm) (Ø body = 110,00 mm)</p> <p>REF 144TA8492 (for steel tracks) (Ø flange = 140,00 mm) (Ø body = 110,00 mm)</p>			<p>REF 144TA7992 (wheel only) (for rubber tracks) (Ø = 376,50 mm)</p>	<p>REF 143TA9636 (rubber) (400 x 72,5 x 72)</p>
SHAEFF HR 22				
<p>REF 144TA8493 (for rubber tracks) (Ø flange = 140,00 mm) (Ø body = 110,00 mm)</p> <p>REF 144TA8494 (for steel tracks) (Ø flange = 140,00 mm) (Ø body = 110,00 mm)</p>			<p>REF 144TA7993 (wheel only) (for rubber tracks) (Ø = 376,50 mm)</p>	<p>REF 143TA9636 (rubber) (400 x 72,5 x 72)</p>



used for SHAEFF				
TRACK ROLLER	TOP ROLLER	SPROCKET	IDLER	TRACK
				
SHAEFF HR 3.7				
<p>REF 144TA9771 (for rubber tracks) (Ø flange = 133,00 mm) (Ø body = 95,00 mm)</p> <p>REF 144TA9774 (for steel tracks) (Ø flange = 115,00 mm) (Ø body = 95,00 mm)</p>		<p>REF 144TA9772 (for rubber tracks) (number of teeth = 21) (number of holes = 12) (total height = 26,00 mm)</p> <p>REF 144TA9775 (for steel tracks) (number of teeth = 21) (number of holes = 12) (total height = 26,00 mm)</p>	<p>REF 144TA9773 (wheel only) (for rubber tracks) (Ø = 311,00 mm)</p> <p>REF 144TA9776 (wheel only) (for steel tracks)</p>	<p>REF 143TA9615 (rubber) (300 x 52,5 x 86)</p>
SHAEFF HR 31				
<p>REF 145TA9381 (for rubber tracks) (inner guide)</p> <p>REF 144TA8496 (for steel tracks) (Ø flange = 180,00 mm) (Ø body = 145,00 mm)</p> <p>REF 144TA8495 (for rubber tracks) (outer guide) (Ø flange = 180,00 mm) (Ø body = 145,00 mm)</p>			<p>REF 143TA9530 (wheel only) (for steel tracks)</p>	<p>REF 143TA9640 (rubber) (450 x 81 x 76)</p>
SHAEFF HR 32				
<p>REF 144TA8497 (for rubber tracks) (inner guide) (Ø flange = 188,00 mm) (Ø body = 135,00 mm)</p> <p>REF 144TA8499 (for steel tracks) (Ø flange = 155,00 mm) (Ø body = 121,00 mm)</p> <p>REF 144TA8498 (for rubber tracks) (outer guide) (Ø flange = 155,00 mm) (Ø body = 121,00 mm)</p>		<p>REF 144TA8165 (for rubber tracks) (number of teeth = 23) (number of holes = 16) (total height = 38,00mm)</p> <p>REF 144TA8166 (for steel tracks)</p>	<p>REF 144TA7994 (wheel only) (for rubber tracks)</p> <p>REF 144TA7995 (wheel only) (for steel tracks)</p>	<p>REF 143TA9962 (rubber) (450 x 71 x 86)</p>
SHAEFF HR 5.0				
<p>REF 144TA8501 (for steel tracks) (Ø flange = 140,00 mm) (Ø body = 110,00 mm)</p> <p>REF 144TA8500 (for rubber tracks) (Ø flange = 140,00 mm) (Ø body = 110,00 mm)</p>		<p>REF 144TA8167 (for rubber tracks)</p> <p>REF 144TA8168 (for steel tracks)</p>	<p>REF 144TA7996 (wheel only) (for rubber tracks)</p> <p>REF 144TA7997 (wheel only) (for steel tracks)</p>	<p>REF 143TA9621 (rubber) (400 x 72,5 x 72)</p>



USED FOR
SUMITOMO

TRACKS & UNDERCARRIAGE PARTS







used for SUMITOMO

used for SUMITOMO				
TRACK ROLLER	TOP ROLLER	SPROCKET	IDLER	TRACK
				
SUMITOMO LS1600C-2				
REF 144TA8668 (for steel tracks) (inner guide)			REF 144TA7998 (front, with bracket assembly) (for steel tracks) (Ø = 428,00 mm)	
REF 144TA8502 (for steel tracks) (outer guide) (Ø flange = 144,00 mm) (Ø body = 118,00 mm)				
SUMITOMO LS1600FJ-2				
REF 144TA8503 (for steel tracks) (outer guide) (Ø flange = 144,00 mm) (Ø body = 118,00 mm)			REF 144TA7999 (front, with bracket assembly) (for steel tracks) (Ø = 428,00 mm)	
REF 144TA8669 (for steel tracks) (inner guide)				
SUMITOMO SH32J				
REF 144TA8549 (for rubber tracks) (Ø flange = 114,00 mm) (Ø body = 90,00 mm)				REF 143TA9691 (rubber) (300 x 52,5 x 84)
SUMITOMO SH55U-2				
REF 144TA8550 (for rubber tracks) (Ø flange = 122,00 mm) (Ø body = 95,00 mm)				REF 164TA3035 (rubber) (400 x 72,5 x 72)
SUMITOMO SH60				
REF 144TA8551 (for rubber tracks)	REF 144TA8325 (assembly) (for rubber tracks)	REF 144TA8196 (for rubber tracks) (number of teeth = 23) (number of holes = 12)	REF 144TA8024 (front, with bracket assembly) (for rubber tracks) (Ø = 428,00 mm)	REF 143TA9756 (rubber) (450 x 71 x 82)
REF 144TA8552 (Ø flange = 144,00 mm) (Ø body = 118,00 mm)				
SUMITOMO SH60-2				
	REF 144TA8326 (assembly) (for rubber tracks)			REF 143TA9756 (rubber) (450 x 71 x 82)
SUMITOMO SH75U				
		REF 144TA8197 (for rubber tracks) (number of teeth = 23) (number of holes = 12)		REF 143TA9963 (rubber) (450 x 71 x 88)
SUMITOMO SH75U-2				
REF 144TA8553 (for rubber tracks) (Ø flange = 144,00 mm) (Ø body = 118,00 mm)	REF 144TA8327 (assembly) (for rubber tracks)		REF 144TA8025 (front, with bracket assembly) (for rubber tracks) (Ø = 428,00 mm)	REF 143TA9963 (rubber) (450 x 71 x 88)
SUMITOMO SH75X-2				
	REF 144TA8328 (assembly) (for rubber tracks) (Ø body = 80,00 mm)			REF 143TA9963 (rubber) (450 x 71 x 88)



USED FOR
SUNWARD



used for SUNWARD				
TRACK ROLLER	TOP ROLLER	SPROCKET	IDLER	TRACK
				
SUNWARD SWE17				
REF 144TA8632 (for rubber tracks) (Ø flange = 108,00 mm) (Ø body = 88,00 mm)		REF 144TA8256 (for rubber tracks) (number of teeth = 19) (number of holes = 8)		REF 143TA9964 (rubber) (230 x 48 x 68)
SUNWARD SWE55				
REF 144TA8633 (for rubber tracks)				REF 143TA9965 (rubber) (400 x 72,5 x 72)
SUNWARD SWE55E				
REF 144TA8634 (for rubber tracks)				REF 143TA9965 (rubber) (400 x 72,5 x 72)
SUNWARD SWE85				
REF 144TA8636 (for steel tracks) (outer guide) (Ø flange = 155,00 mm) (Ø body = 121,00 mm)	REF 144TA8406 (assembly) (for steel tracks) (Ø flange = 120,00 mm) (Ø body = 90,70 mm)	REF 144TA8257 (for steel tracks) (number of teeth = 21) (number of holes = 12)	REF 144TA8087 (front, with bracket assembly) (for steel tracks)	REF 143TA9966 (rubber) (450 x 76 x 82)
REF 144TA8635 (for rubber tracks) (outer guide) (Ø flange = 155,00 mm) (Ø body = 121,00 mm)	REF 144TA8405 (assembly) (for rubber tracks) (Ø flange = 120,00 mm) (Ø body = 90,70 mm)		REF 144TA8086 (front, with bracket assembly) (for rubber tracks)	







USED FOR
TAKEUCHI





TRACKS & UNDERCARRIAGE PARTS



used for TAKEUCHI

used for TAKEUCHI				
TRACK ROLLER	TOP ROLLER	SPROCKET	IDLER	TRACK
				
TAKEUCHI TB014				
<i>S/N: 11400001 - 11401973</i>				
		REF 144TA1907 (for rubber tracks) (number of teeth = 19) (number of holes = 9) REF 144TA8259 (for rubber tracks) (number of teeth = 19) (number of holes = 9)		
<i>S/N: 11400003 - 11400328</i>				
		REF 144TA8259 (for rubber tracks) (number of teeth = 19) (number of holes = 9)		REF 163TA9176 (rubber) (230 x 48 x 62)
<i>S/N: 11400003 - 11400436</i>				
		REF 144TA8258 (for rubber tracks) (number of teeth = 19) (number of holes = 9) REF 144TA8259 (for rubber tracks) (number of teeth = 19) (number of holes = 9)		
<i>S/N: 11400003 - 11401973</i>				
REF 144TA7933 (for rubber tracks) (Ø flange = 108,00 mm) (Ø body = 88,00 mm) REF 163TA9197 (for steel tracks)		REF 144TA8259 (for rubber tracks) (number of teeth = 19) (number of holes = 9)	REF 163TA9210 (front, with bracket assembly) (for rubber tracks)	
<i>S/N: 11400329 - 11400424</i>				
		REF 144TA8259 (for rubber tracks) (number of teeth = 19) (number of holes = 9)		REF 163TA9177 (rubber) (230 x 48 x 62)
<i>S/N: 11400425 - 11401973</i>				
		REF 144TA8259 (for rubber tracks) (number of teeth = 19) (number of holes = 9)		REF 143TA9967 (rubber) (230 x 48 x 62)
<i>S/N: 11410001 - and up</i>				
REF 144TA7933 (for rubber tracks) (Ø flange = 108,00 mm) (Ø body = 88,00 mm)		REF 144TA8259 (for rubber tracks) (number of teeth = 19) (number of holes = 9)	REF 163TA9210 (front, with bracket assembly) (for rubber tracks)	REF 143TA9967 (rubber) (230 x 48 x 62)
TAKEUCHI TB014A				
			REF 144TA8088 (front, with bracket assembly) (for rubber tracks)	REF 143TA9967 (rubber) (230 x 48 x 62)
TAKEUCHI TB014LSA				
			REF 144TA8089 (front, with bracket assembly) (for rubber tracks)	REF 143TA9967 (rubber) (230 x 48 x 62)



used for TAKEUCHI				
TRACK ROLLER	TOP ROLLER	SPROCKET	IDLER	TRACK
				
TAKEUCHI TB014S				
			REF 144TA8090 (front, with bracket assembly) (for rubber tracks)	REF 143TA9967 (rubber) (230 x 48 x 62)
TAKEUCHI TB015				
<i>S/N: 00000543 - and up</i>				
REF 163TA9315 (for rubber tracks)		REF 163TA9279 (for rubber tracks) (number of teeth = 14) (number of holes = 9)	REF 144TA8093 (front, with bracket assembly) (for rubber tracks)	REF 163TA9264 (rubber) (230 x 72 x 43)
<i>S/N: 01153001 - 01154135</i>				
REF 163TA9315 (for rubber tracks)		REF 163TA9279 (for rubber tracks) (number of teeth = 14) (number of holes = 9)	REF 144TA8093 (front, with bracket assembly) (for rubber tracks)	REF 163TA9178 (rubber) (230 x 48 x 62) REF 163TA9264 (rubber) (230 x 72 x 43)
<i>S/N: 01153001 - 01158122</i>				
REF 163TA9198 (for rubber tracks) (∅ flange = 112,00 mm) (∅ body = 88,00 mm) REF 163TA9315 (for rubber tracks)		REF 163TA9279 (for rubber tracks) (number of teeth = 14) (number of holes = 9)	REF 163TA9210 (front, with bracket assembly) (for rubber tracks) REF 144TA8093 (front, with bracket assembly) (for rubber tracks)	REF 163TA9264 (rubber) (230 x 72 x 43)
<i>S/N: 01154136 - 01155628</i>				
REF 163TA9315 (for rubber tracks)		REF 163TA9279 (for rubber tracks) (number of teeth = 14) (number of holes = 9)	REF 144TA8093 (front, with bracket assembly) (for rubber tracks)	REF 163TA9179 (rubber) (230 x 48 x 62) REF 163TA9264 (rubber) (230 x 72 x 43)
<i>S/N: 01155629 - and up</i>				
REF 163TA9315 (for rubber tracks)		REF 163TA9279 (for rubber tracks) (number of teeth = 14) (number of holes = 9)	REF 144TA8093 (front, with bracket assembly) (for rubber tracks)	REF 163TA9176 (rubber) (230 x 48 x 62) REF 163TA9177 (rubber) (230 x 48 x 62) REF 163TA9264 (rubber) (230 x 72 x 43)
<i>S/N: 10153001 - 01158122</i>				
REF 163TA9315 (for rubber tracks)		REF 144TA8260 (for rubber tracks) (number of teeth = 19) (number of holes = 9) REF 163TA9279 (for rubber tracks) (number of teeth = 14) (number of holes = 9)	REF 144TA8093 (front, with bracket assembly) (for rubber tracks)	REF 163TA9264 (rubber) (230 x 72 x 43)
TAKEUCHI TB015A				
			REF 144TA8094 (front, with bracket assembly) (for rubber tracks)	REF 143TA9967 (rubber) (230 x 48 x 62)



used for TAKEUCHI				
TRACK ROLLER	TOP ROLLER	SPROCKET	IDLER	TRACK
				
				REF 143TA9968 (rubber) (230 x 48 x 68)
TAKEUCHI TB015FR				
<i>S/N: 11610001 - and up</i>				
REF 144TA7933 (for rubber tracks) (∅ flange = 108,00 mm) (∅ body = 88,00 mm)				
<i>S/N: 11801004 - 11810138</i>				
REF 144TA7933 (for rubber tracks) (∅ flange = 108,00 mm) (∅ body = 88,00 mm)		REF 163TA9279 (for rubber tracks) (number of teeth = 14) (number of holes = 9)	REF 163TA9210 (front, with bracket assembly) (for rubber tracks)	REF 163TA9339 (rubber) (230 x 48 x 70)
TAKEUCHI TB016				
<i>S/N: 11600003 - and up</i>				
REF 144TA7933 (for rubber tracks) (∅ flange = 108,00 mm) (∅ body = 88,00 mm)		REF 144TA8261 (for rubber tracks) (number of teeth = 19) (number of holes = 9)	REF 144TA8095 (front, with bracket assembly) (for rubber tracks)	REF 163TA9290 (rubber) (230 x 96 x 34)
REF 163TA9197 (for steel tracks)				
<i>S/N: 11600686 - 11601291</i>				
REF 144TA7933 (for rubber tracks) (∅ flange = 108,00 mm) (∅ body = 88,00 mm)		REF 144TA8261 (for rubber tracks) (number of teeth = 19) (number of holes = 9)	REF 144TA8095 (front, with bracket assembly) (for rubber tracks)	REF 143TA9968 (rubber) (230 x 48 x 68)
REF 163TA9197 (for steel tracks)				
<i>S/N: 11601292 - and up</i>				
REF 144TA7933 (for rubber tracks) (∅ flange = 108,00 mm) (∅ body = 88,00 mm)		REF 144TA8261 (for rubber tracks) (number of teeth = 19) (number of holes = 9)	REF 144TA8095 (front, with bracket assembly) (for rubber tracks)	REF 163TA9252 (rubber) (230 x 48 x 68)
REF 163TA9197 (for steel tracks)				
<i>S/N: 11610001 - and up</i>				
REF 144TA7933 (for rubber tracks) (∅ flange = 108,00 mm) (∅ body = 88,00 mm)		REF 144TA8261 (for rubber tracks) (number of teeth = 19) (number of holes = 9)	REF 144TA8095 (front, with bracket assembly) (for rubber tracks)	
REF 163TA9197 (for steel tracks)				
TAKEUCHI TB016LSA				
			REF 144TA8096 (front, with bracket assembly) (for rubber tracks)	REF 143TA9968 (rubber) (230 x 48 x 68)
TAKEUCHI TB025				
<i>S/N: 01255001 - 01257556</i>				
REF 163TA9199 (for rubber tracks) (∅ flange = 133,00 mm) (∅ body = 93,00 mm)	REF 163TA9207 (assembly) (for rubber tracks)	REF 163TA9191 (for rubber tracks) (number of teeth = 23) (number of holes = 9)	REF 144TA8097 (front, with bracket assembly) (for rubber tracks) (∅ = 345,00 mm)	REF 163TA9180 (rubber) (300 x 52,5 x 78)

TRACKS & UNDERCARRIAGE PARTS



used for TAKEUCHI

used for TAKEUCHI				
TRACK ROLLER	TOP ROLLER	SPROCKET	IDLER	TRACK
				
<i>S/N: 01257557 - and up</i>				
REF 163TA9199 (for rubber tracks) (∅ flange = 133,00 mm) (∅ body = 93,00 mm)	REF 163TA9207 (assembly) (for rubber tracks)	REF 163TA9191 (for rubber tracks) (number of teeth = 23) (number of holes = 9)	REF 144TA8097 (front, with bracket assembly) (for rubber tracks) (∅ = 345,00 mm)	REF 163TA9181 (rubber) (300 x 52,5 x 78)
TAKEUCHI TB025FR				
<i>S/N: 12810004 - 12810091</i>				
REF 144TA1874 (for rubber tracks) (∅ flange = 118,00 mm) (∅ body = 94,00 mm)	REF 144TA7934 (assembly) (for rubber tracks) (∅ body = 75,00 mm)	REF 163TA9337 (for rubber tracks)	REF 163TA9286 (front, with bracket assembly) (for rubber tracks) (∅ = 346,00 mm)	REF 163TA9267 (rubber) (300 x 52,5 x 78)
<i>S/N: 12810092 - and up</i>				
REF 144TA1874 (for rubber tracks) (∅ flange = 118,00 mm) (∅ body = 94,00 mm)	REF 144TA7934 (assembly) (for rubber tracks) (∅ body = 75,00 mm)	REF 163TA9337 (for rubber tracks)	REF 163TA9286 (front, with bracket assembly) (for rubber tracks) (∅ = 346,00 mm)	REF 163TA9287 (rubber) (300 x 52,5 x 82)
TAKEUCHI TB035				
<i>S/N: 01355001 - 01357527</i>				
REF 144TA8639 (for rubber tracks) (∅ flange = 133,00 mm) (∅ body = 93,00 mm)	REF 144TA7934 (assembly) (for rubber tracks) (∅ body = 75,00 mm)	REF 163TA9191 (for rubber tracks) (number of teeth = 23) (number of holes = 9)	REF 144TA8098 (front, with bracket assembly) (for rubber tracks) (∅ = 346,00 mm)	REF 163TA9182 (rubber) (350 x 52,5 x 86)
<i>S/N: 01357528 - and up</i>				
REF 144TA8639 (for rubber tracks) (∅ flange = 133,00 mm) (∅ body = 93,00 mm)	REF 144TA7934 (assembly) (for rubber tracks) (∅ body = 75,00 mm)	REF 163TA9191 (for rubber tracks) (number of teeth = 23) (number of holes = 9)	REF 144TA8098 (front, with bracket assembly) (for rubber tracks) (∅ = 346,00 mm)	REF 143TA9970 (rubber) (350 x 52,5 x 86)
TAKEUCHI TB045				
<i>S/N: 01455001 - 01456564</i>				
REF 144TA7936 (for rubber tracks) (∅ flange = 140,00 mm) (∅ body = 110,00 mm)	REF 144TA8407 (assembly) (for rubber tracks) (∅ body = 83,00 mm)	REF 163TA9192 (for rubber tracks)	REF 144TA7937 (front, with bracket assembly) (for rubber tracks) (∅ = 389,00 mm)	REF 163TA9183 (rubber) (400 x 72,5 x 74)
<i>S/N: 01456565 - and up</i>				
REF 144TA7936 (for rubber tracks) (∅ flange = 140,00 mm) (∅ body = 110,00 mm)	REF 144TA8407 (assembly) (for rubber tracks) (∅ body = 83,00 mm)	REF 163TA9192 (for rubber tracks)	REF 144TA7937 (front, with bracket assembly) (for rubber tracks) (∅ = 389,00 mm)	REF 163TA9184 (rubber) (400 x 72,5 x 74)
TAKEUCHI TB070				
<i>S/N: 01703004 - 01704323</i>				
	REF 144TA8408 (assembly) (for rubber tracks) (∅ body = 98,00 mm)	REF 144TA8262 (for rubber tracks) (number of teeth = 21) (number of holes = 12)	REF 144TA8099 (front, with bracket assembly) (for rubber tracks) (∅ = 492,00 mm)	REF 163TA9185 (rubber) (450 x 81 x 76)
<i>S/N: 01703004 - 01704709</i>				
REF 163TA9200 (for rubber tracks) (∅ flange = 143,50 mm) (∅ body = 120,00 mm)	REF 144TA8408 (assembly) (for rubber tracks) (∅ body = 98,00 mm)	REF 144TA8262 (for rubber tracks) (number of teeth = 21) (number of holes = 12)	REF 144TA8099 (front, with bracket assembly) (for rubber tracks) (∅ = 492,00 mm)	
<i>S/N: 01704324 - and up</i>				
	REF 144TA8408 (assembly) (for rubber tracks) (∅ body = 98,00 mm)	REF 144TA8262 (for rubber tracks) (number of teeth = 21) (number of holes = 12)	REF 144TA8099 (front, with bracket assembly) (for rubber tracks) (∅ = 492,00 mm)	REF 143TA9972 (rubber) (450 x 81w x 76)



used for TAKEUCHI				
TRACK ROLLER	TOP ROLLER	SPROCKET	IDLER	TRACK
				
<i>S/N: 01704710 - and up</i>				
REF 163TA9201 (for rubber tracks) (Ø flange = 143,50 mm) (Ø body = 120,00 mm)	REF 144TA8408 (assembly) (for rubber tracks) (Ø body = 98,00 mm)	REF 144TA8262 (for rubber tracks) (number of teeth = 21) (number of holes = 12)	REF 144TA8099 (front, with bracket assembly) (for rubber tracks) (Ø = 492,00 mm)	
TAKEUCHI TB108				
REF 143TA8820 (for rubber tracks) (Ø flange = 130,00 mm) (Ø body = 60,00 mm)		REF 163TA9265 (for rubber tracks)	REF 143TA9532 (front, with bracket assembly) (for rubber tracks) (Ø = 250,00 mm)	REF 143TA9973 (rubber) (180 x 72 x 37)
TAKEUCHI TB1140				
<i>S/N: 51400005 - and up</i>				
REF 163TA9202 (for rubber tracks)	REF 163TA9270 (assembly) (for rubber tracks) (Ø flange = 118,00 mm) (Ø body = 100,00 mm)		REF 163TA9212 (front, with bracket assembly) (for steel tracks) (Ø = 490,00 mm)	REF 143TA9974 (rubber) (500 x 92 x 84)
REF 144TA7938 (Ø flange = 166,00 mm) (Ø body = 137,00 mm)				
REF 163TA9271 (for rubber tracks) (outer guide) (flange diameter = 166,00 mm) (body Ø = 137,00 mm)				
<i>S/N: 51410002 - and up</i>				
REF 163TA9203	REF 163TA9208 (assembly) (for rubber tracks) (Ø flange = 140,00 mm) (Ø body = 120,00 mm)	REF 163TA9194 (number of teeth = 23) (number of holes = 15)	REF 163TA9213 (front, with bracket assembly)	REF 143TA9974 (rubber) (500 x 92 x 84)
TAKEUCHI TB12				
REF 144TA8641 (for rubber tracks) (Ø flange = 129,50 mm) (Ø body = 68,00 mm)				REF 164TA3074 (rubber) (230 x 72 x 43)
TAKEUCHI TB120				
			REF 144TA8100 (front, with bracket assembly) (for rubber tracks) (Ø = 286,00 mm)	REF 143TA9714 (rubber) (450 x 100 x 48)
TAKEUCHI TB120R				
			REF 144TA8101 (front, with bracket assembly) (for rubber tracks) (Ø = 286,00 mm)	REF 143TA9714 (rubber) (450 x 100 x 48)
TAKEUCHI TB125				
<i>S/N: 12510009 - 12513451</i>				
REF 144TA1874 (Ø flange = 118,00 mm) (Ø body = 94,00 mm)	REF 144TA7934 (assembly) (for rubber tracks) (Ø body = 75,00 mm)	REF 143TA9113 (for rubber tracks) (number of teeth = 23) (number of holes = 9)	REF 144TA8102 (front, with bracket assembly) (for rubber tracks) (Ø = 346,00 mm)	REF 143TA9969 (rubber) (300 x 52,5 x 78)
<i>S/N: 12513452 - and up</i>				
REF 144TA1874 (Ø flange = 118,00 mm) (Ø body = 94,00 mm)	REF 144TA1877 (assembly) (Ø body = 75,00 mm)	REF 143TA9113 (for rubber tracks) (number of teeth = 23) (number of holes = 9)	REF 144TA8102 (front, with bracket assembly) (for rubber tracks) (Ø = 346,00 mm)	REF 143TA9969 (rubber) (300 x 52,5 x 78)



used for TAKEUCHI				
TRACK ROLLER	TOP ROLLER	SPROCKET	IDLER	TRACK
				
TAKEUCHI TB135				
<i>S/N: 13510004 - 13512646</i>				
REF 144TA8643 (for rubber tracks) (Ø flange = 118,00 mm) (Ø body = 94,00 mm)	REF 144TA8410 (assembly) (for rubber tracks) (Ø body = 75,00 mm)	REF 144TA7935 (for rubber tracks) (number of teeth = 23) (number of holes = 9)	REF 144TA8103 (front, with bracket assembly) (for rubber tracks) (Ø = 346,00 mm)	REF 143TA9970 (rubber) (350 x 52,5 x 86)
<i>S/N: 13512647 - and up</i>				
REF 144TA8643 (for rubber tracks) (Ø flange = 118,00 mm) (Ø body = 94,00 mm)	REF 144TA8410 (assembly) (for rubber tracks) (Ø body = 75,00 mm)	REF 144TA7935 (for rubber tracks) (number of teeth = 23) (number of holes = 9)	REF 163TA9286 (front, with bracket assembly) (for rubber tracks) (Ø = 346,00 mm)	REF 143TA9970 (rubber) (350 x 52,5 x 86)
TAKEUCHI TB138FR				
<i>S/N: 00010003 - 00020000</i>				
REF 144TA8644 (Ø flange = 118,00 mm) (Ø body = 94,00 mm)	REF 143TA8998 (assembly) (for rubber tracks) (Ø body = 75,00 mm)	REF 144TA7935 (for rubber tracks) (number of teeth = 23) (number of holes = 9)	REF 143TA9533 (front, with bracket assembly) (for rubber tracks)	REF 143TA9783 (rubber) (350 x 52,5 x 86)
<i>S/N: 00020001 - and up</i>				
REF 144TA8644 (Ø flange = 118,00 mm) (Ø body = 94,00 mm)	REF 143TA8998 (assembly) (for rubber tracks) (Ø body = 75,00 mm)	REF 143TA9113 (for rubber tracks) (number of teeth = 23) (number of holes = 9)	REF 143TA9533 (front, with bracket assembly) (for rubber tracks)	REF 143TA9783 (rubber) (350 x 52,5 x 86)
TAKEUCHI TB14				
REF 144TA8645 (for rubber tracks) (Ø flange = 129,50 mm) (Ø body = 68,00 mm)				REF 164TA3074 (rubber) (230 x 72 x 43)
TAKEUCHI TB145				
REF 144TA8646 (for rubber tracks) (Ø flange = 140,00 mm) (Ø body = 110,00 mm)	REF 144TA8412 (assembly) (for rubber tracks) (Ø body = 83,00 mm)	REF 163TA9192 (for rubber tracks)	REF 144TA7937 (front, with bracket assembly) (for rubber tracks) (Ø = 389,00 mm)	REF 143TA9971 (rubber) (400 x 72,5 x 74)
TAKEUCHI TB15				
REF 163TA9315 (for rubber tracks)		REF 163TA9279 (for rubber tracks) (number of teeth = 14) (number of holes = 9)	REF 163TA9295 (front, with bracket assembly) (for rubber tracks) (Ø = 286,00 mm)	REF 143TA9714 (rubber) (450 x 100 x 48)
REF 144TA8637 (for rubber tracks) (Ø flange = 112,00 mm) (Ø body = 88,00 mm)		REF 163TA9240 (for steel tracks)		
TAKEUCHI TB153FR				
REF 144TA8647 (for rubber tracks) (Ø flange = 140,00 mm) (Ø body = 110,00 mm)	REF 144TA8413 (assembly) (for rubber tracks) (Ø body = 83,00 mm)	REF 163TA9192	REF 144TA7937 (front, with bracket assembly) (for rubber tracks) (Ø = 389,00 mm)	REF 164TA3017 (rubber) (400 x 72,5 x 74)
TAKEUCHI TB15FR				
REF 144TA7933 (for rubber tracks) (Ø flange = 108,00 mm) (Ø body = 88,00 mm)		REF 144TA1907 (number of teeth = 19) (number of holes = 9)	REF 163TA9210 (front, with bracket assembly)	REF 163TA9339 (rubber) (230 x 48 x 70)
TAKEUCHI TB175				
<i>S/N: up to - 17510098</i>				
REF 144TA8648 (for rubber tracks) (Ø flange = 148,00 mm) (Ø body = 120,00 mm)	REF 144TA8414 (assembly) (for rubber tracks) (Ø body = 98,00 mm)	REF 144TA8263 (for rubber tracks)	REF 144TA8105 (front, with bracket assembly) (for rubber tracks) (Ø = 492,00 mm)	

TRACKS & UNDERCARRIAGE PARTS



used for TAKEUCHI

used for TAKEUCHI				
TRACK ROLLER	TOP ROLLER	SPROCKET	IDLER	TRACK
				
<i>S/N: 17510003 - and up</i>				
REF 144TA8648 (for rubber tracks) (Ø flange = 148,00 mm) (Ø body = 120,00 mm)	REF 163TA9209 (assembly) (for rubber tracks) (Ø body = 98,00 mm)	REF 144TA8264 (for rubber tracks)	REF 144TA8106 (front, with bracket assembly) (for rubber tracks) (Ø = 492,00 mm)	REF 143TA9972 (rubber) (450 x 81w x 76)
TAKEUCHI TB180FR				
<i>S/N: 17830004 - 17830041</i>				
REF 144TA8649 (for rubber tracks) (Ø flange = 148,00 mm) (Ø body = 120,00 mm)	REF 163TA9209 (assembly) (for rubber tracks) (Ø body = 98,00 mm)	REF 144TA8265 (for rubber tracks)	REF 144TA8107 (front, with bracket assembly) (for rubber tracks) (Ø = 492,00 mm)	REF 164TA3038 (rubber) (450 x 81 x 76)
<i>S/N: 17830042 - and up</i>				
REF 163TA9314 (for rubber tracks)	REF 163TA9209 (assembly) (for rubber tracks) (Ø body = 98,00 mm)	REF 144TA8265 (for rubber tracks)	REF 144TA8107 (front, with bracket assembly) (for rubber tracks) (Ø = 492,00 mm)	REF 164TA3038 (rubber) (450 x 81 x 76)
TAKEUCHI TB21				
REF 143TA8823 (for steel tracks)		REF 143TA9243 (for rubber tracks)	REF 143TA9534 (front, with bracket assembly) (for steel tracks)	REF 143TA9975 (rubber) (320 x 100 x 38)
REF 163TA9317 (for rubber tracks) (Ø flange = 150,00 mm) (Ø body = 75,00 mm)		REF 143TA9242 (for steel tracks)	REF 163TA9316 (front, with bracket assembly) (for rubber tracks)	
TAKEUCHI TB210R				
				REF 163TA9445 (rubber) (180 x 72 x 40)
TAKEUCHI TB215R				
				REF 163TA9252 (rubber) (230 x 48 x 68)
TAKEUCHI TB216				
				REF 163TA9252 (rubber) (230 x 48 x 68)
TAKEUCHI TB219				
				REF 163TA9255 (rubber) (230 x 48 x 70)
TAKEUCHI TB228				
REF 144TA8651 (for rubber tracks) (Ø flange = 118,00 mm) (Ø body = 94,00 mm)	REF 143TA8998 (assembly) (for rubber tracks) (Ø body = 75,00 mm)	REF 143TA9244 (for rubber tracks) (number of teeth = 23) (number of holes = 9)	REF 144TA8108 (front, with bracket assembly) (for rubber tracks) (Ø = 346,00 mm)	REF 143TA9969 (rubber) (300 x 52,5 x 78)
TAKEUCHI TB235				
REF 144TA8652 (for rubber tracks) (Ø flange = 118,00 mm) (Ø body = 94,00 mm)	REF 143TA8998 (assembly) (for rubber tracks) (Ø body = 75,00 mm)	REF 143TA9113 (for rubber tracks) (number of teeth = 23) (number of holes = 9)	REF 143TA9533 (front, with bracket assembly) (for rubber tracks)	REF 143TA9783 (rubber) (350 x 52,5 x 86)
TAKEUCHI TB23R				
<i>S/N: 12300007 - 12300512</i>				
REF 144TA7941 (for rubber tracks) (Ø flange = 125,00 mm) (Ø body = 83,20 mm)		REF 144TA7940 (for rubber tracks) (number of teeth = 23) (number of holes = 9)	REF 163TA9272 (front, with bracket assembly) (for rubber tracks) (Ø = 310,00 mm)	REF 143TA9930 (rubber) (250 x 48 x 82)



used for TAKEUCHI				
TRACK ROLLER	TOP ROLLER	SPROCKET	IDLER	TRACK
				
			REF 143TA9535 (front, with bracket assembly) (for steel tracks) (Ø = 300,00 mm)	
<i>S/N: 12300513 - and up</i>				
REF 144TA7939 (for rubber tracks) (Ø flange = 124,20 mm) (Ø body = 82,00 mm)		REF 144TA7940 (for rubber tracks) (number of teeth = 23) (number of holes = 9)	REF 163TA9272 (front, with bracket assembly) (for rubber tracks) (Ø = 310,00 mm) REF 143TA9535 (front, with bracket assembly) (for steel tracks) (Ø = 300,00 mm)	REF 143TA9930 (rubber) (250 x 48 x 82)
TAKEUCHI TB25				
REF 144TA8638 (for rubber tracks) (Ø flange = 150,00 mm) (Ø body = 75,00 mm) REF 143TA8823 (for steel tracks)		REF 163TA9322 (for rubber tracks) REF 163TA9321 (for steel tracks)	REF 143TA9534 (front, with bracket assembly) (for steel tracks) REF 143TA9562 (front, with bracket assembly) (for rubber tracks)	REF 163TA9323 (rubber) (320 x 100 x 43)
TAKEUCHI TB250				
REF 163TA9204 (Ø flange = 136,00 mm) (Ø body = 110,00 mm)	REF 143TA9000 (assembly) (for rubber tracks) (Ø body = 83,00 mm)	REF 144TA8268	REF 144TA7937 (front, with bracket assembly) (for rubber tracks) (Ø = 389,00 mm)	REF 163TA9186 (rubber) (400 x 72,5 x 74)
TAKEUCHI TB250-125				
REF 144TA8653 (for rubber tracks) (Ø flange = 140,00 mm) (Ø body = 110,00 mm)			REF 144TA7937 (front, with bracket assembly) (for rubber tracks) (Ø = 389,00 mm)	REF 163TA9289 (rubber) (320 x 100 x 40)
TAKEUCHI TB280FR				
				REF 163TA9444 (rubber) (450 x 81 x 76)
TAKEUCHI TB28FR				
<i>S/N: 12820004 - 12820260</i>				
REF 144TA8655 (for rubber tracks) (Ø flange = 118,00 mm) (Ø body = 94,00 mm)	REF 144TA7934 (assembly) (for rubber tracks) (Ø body = 75,00 mm)	REF 143TA9113 (for rubber tracks) (number of teeth = 23) (number of holes = 9)	REF 144TA8109 (front, with bracket assembly) (for rubber tracks) (Ø = 346,00 mm)	
<i>S/N: 12820004 - 12820272</i>				
REF 144TA8655 (for rubber tracks) (Ø flange = 118,00 mm) (Ø body = 94,00 mm)		REF 143TA9113 (for rubber tracks) (number of teeth = 23) (number of holes = 9)	REF 144TA8109 (front, with bracket assembly) (for rubber tracks) (Ø = 346,00 mm)	REF 163TA9287 (rubber) (300 x 52,5 x 82)
<i>S/N: 12820261 - and up</i>				
REF 144TA8655 (for rubber tracks) (Ø flange = 118,00 mm) (Ø body = 94,00 mm)	REF 144TA1877 (assembly) (for rubber tracks) (Ø body = 75,00 mm)	REF 143TA9113 (for rubber tracks) (number of teeth = 23) (number of holes = 9)	REF 144TA8109 (front, with bracket assembly) (for rubber tracks) (Ø = 346,00 mm)	
<i>S/N: 12820273 - and up</i>				
REF 144TA8655 (for rubber tracks) (Ø flange = 118,00 mm) (Ø body = 94,00 mm)		REF 143TA9113 (for rubber tracks) (number of teeth = 23) (number of holes = 9)	REF 144TA8109 (front, with bracket assembly) (for rubber tracks) (Ø = 346,00 mm)	REF 163TA9288 (rubber) (300 x 52,5 x 82)

TRACKS & UNDERCARRIAGE PARTS



used for TAKEUCHI

used for TAKEUCHI				
TRACK ROLLER	TOP ROLLER	SPROCKET	IDLER	TRACK
				
TAKEUCHI TB35				
		REF 144TA7935 (for rubber tracks) (number of teeth = 23) (number of holes = 9)		REF 143TA9978 (rubber) (320 x 100 x 46)
TAKEUCHI TB36				
REF 163TA9434 (for rubber tracks) (Ø flange = 165,00 mm)	REF 143TA9001 (assembly) (for rubber tracks)	REF 163TA9433 (for rubber tracks)	REF 163TA9318 (front, with bracket assembly) (for steel tracks)	REF 163TA9324 (rubber) (320 x 100 x 46)
REF 163TA9313 (for steel tracks)		REF 163TA9320 (for steel tracks)	REF 163TA9319 (front, with bracket assembly) (for rubber tracks)	
TAKEUCHI TB45				
REF 163TA9336 (for steel tracks)	REF 163TA9335 (assembly) (for steel tracks)	REF 144TA8270 (for rubber tracks)		REF 163TA9451 (rubber) (420 x 100 x 80)
REF 163TA9450 (for rubber tracks)		REF 163TA9449 (for rubber tracks) (number of teeth = 19) (number of holes = 12) (total height = 32,20 mm)		
TAKEUCHI TB53FR				
<i>S/N: 15810005 - 15810524</i>				
REF 144TA8658 (for rubber tracks) (Ø flange = 140,00 mm) (Ø body = 110,00 mm)	REF 144TA8416 (assembly) (for rubber tracks) (Ø body = 83,00 mm)	REF 163TA9192 (for rubber tracks)	REF 144TA7937 (front, with bracket assembly) (for rubber tracks) (Ø = 389,00 mm)	REF 163TA9187 (rubber) (400 x 72,5 x 74)
<i>S/N: 15810525 - and up</i>				
REF 144TA8658 (for rubber tracks) (Ø flange = 140,00 mm) (Ø body = 110,00 mm)	REF 144TA8416 (assembly) (for rubber tracks) (Ø body = 83,00 mm)	REF 163TA9192 (for rubber tracks)	REF 144TA7937 (front, with bracket assembly) (for rubber tracks) (Ø = 389,00 mm)	REF 143TA9971 (rubber) (400 x 72,5 x 74)
TAKEUCHI TB68				
<i>S/N: 00068003 - 00068806</i>				
REF 144TA8659 (Ø flange = 216,10 mm) (Ø body = 112,40 mm)	REF 143TA9001 (assembly)	REF 163TA9309 (for steel tracks)	REF 163TA9307 (front, with bracket assembly) (for steel tracks)	REF 164TA3082 (rubber) (450 x 71 x 80)
		REF 163TA9311 (for rubber tracks)	REF 163TA9310 (front, with bracket assembly) (for rubber tracks)	
<i>S/N: 00068807 - and up</i>				
REF 144TA8659 (Ø flange = 216,10 mm) (Ø body = 112,40 mm)	REF 143TA9001 (assembly)	REF 163TA9312 (for steel tracks)	REF 163TA9308 (front, with bracket assembly) (for rubber tracks)	REF 164TA3082 (rubber) (450 x 71 x 80)
		REF 163TA9311 (for rubber tracks)		
TAKEUCHI TB80FR				
<i>S/N: 17810006 - 17810114</i>				
REF 163TA9201 (for rubber tracks) (Ø flange = 143,50 mm) (Ø body = 120,00 mm)	REF 163TA9338 (assembly) (for rubber tracks)	REF 163TA9193 (for rubber tracks)	REF 144TA8110 (front, with bracket assembly) (for rubber tracks) (Ø = 492,00 mm)	REF 164TA3038 (rubber) (450 x 81 x 76)



used for TAKEUCHI				
TRACK ROLLER	TOP ROLLER	SPROCKET	IDLER	TRACK
				
<i>S/N: 17820001 - and up</i>				
REF 163TA9273 (for rubber tracks) (∅ flange = 143,50 mm) (∅ body = 120,00 mm)	REF 163TA9209 (assembly) (for rubber tracks)	REF 144TA8272 (for rubber tracks)	REF 144TA8110 (front, with bracket assembly) (for rubber tracks) (∅ = 492,00 mm)	REF 164TA3038 (rubber) (450 x 81 x 76)
TAKEUCHI TCR50				
<i>S/N: 30500003 - 30500038</i>				
REF 163TA9275 (for rubber tracks)	REF 144TA8418 (assembly) (for rubber tracks) (∅ flange = 260,00 mm)	REF 163TA9277 (for rubber tracks)	REF 163TA9276 (front, with bracket assembly) (for rubber tracks)	REF 143TA9980 (rubber) (450 x 110 x 74)
<i>S/N: 30510001 - and up</i>				
REF 163TA9275 (for rubber tracks)	REF 144TA8418 (assembly) (for rubber tracks) (∅ flange = 260,00 mm)	REF 144TA8273 (for rubber tracks) (number of teeth = 17) (number of holes = 15)	REF 163TA9276 (front, with bracket assembly) (for rubber tracks)	REF 143TA9980 (rubber) (450 x 110 x 74)
TAKEUCHI TL10				
REF 163TA9281		REF 163TA9279 (for rubber tracks) (number of teeth = 14) (number of holes = 9) REF 163TA9240 (for steel tracks)	REF 163TA9280 (rear, with bracket assembly)	REF 164TA3074 (rubber) (230 x 72 x 43) REF 143TA9714 (rubber) (450 x 100 x 48)
TAKEUCHI TL120				
REF 143TA8830 (for rubber tracks) (∅ flange = 180,00 mm) (∅ body = 100,00 mm) REF 143TA9570 (for rubber tracks) (∅ flange = 228,00 mm) (∅ body = 88,00 mm)		REF 143TA9249 (for rubber tracks)	REF 143TA9569 (front, with bracket assembly) (for rubber tracks)	REF 143TA9982 (rubber) (320 x 86 x 46)
TAKEUCHI TL126				
REF 144TA7942 (for rubber tracks) (∅ flange = 166,00 mm) (∅ body = 137,00 mm) REF 143TA9570 (for rubber tracks) (rear) (∅ flange = 228,00 mm) (∅ body = 88,00 mm)		REF 143TA9250 (for rubber tracks) (number of teeth = 16) (number of holes = 16)	REF 144TA8112 (front, with bracket assembly) (for rubber tracks) (∅ = 400,00 mm)	REF 163TA9188 (rubber) (320 x 86 x 48)
TAKEUCHI TL130				
REF 144TA7942 (for rubber tracks) (∅ flange = 166,00 mm) (∅ body = 137,00 mm) REF 163TA9205 (for rubber tracks) (rear)		REF 144TA8275 (for rubber tracks) (number of teeth = 16) (number of holes = 9)	REF 144TA8113 (front, with bracket assembly) (for rubber tracks) (∅ = 400,00 mm)	REF 143TA9713 (rubber) (320 x 86 x 52)
TAKEUCHI TL140				
<i>S/N: 21400011 - 21401390</i>				
REF 144TA8661 (for rubber tracks) (∅ flange = 216,10 mm) (∅ body = 112,40 mm) REF 163TA9206 (for rubber tracks) (rear)		REF 144TA8276 (for rubber tracks) (number of teeth = 14) (number of holes = 9)	REF 143TA9537 (front, with bracket assembly) (for rubber tracks) (∅ = 450,00 mm)	REF 163TA9189 (rubber) (450 x 100 x 50)

TRACKS & UNDERCARRIAGE PARTS





used for TAKEUCHI

used for TAKEUCHI				
TRACK ROLLER	TOP ROLLER	SPROCKET	IDLER	TRACK
				
<i>For all other serial ranges applicable</i>				
REF 163TA9206 (for rubber tracks) (rear)		REF 144TA8276 (for rubber tracks) (number of teeth = 14) (number of holes = 9)	REF 143TA9537 (front, with bracket assembly) (for rubber tracks) (Ø = 450,00 mm)	REF 163TA9189 (rubber) (450 x 100 x 50)
TAKEUCHI TL150				
REF 144TA8662 (for rubber tracks) (Ø flange = 216,10 mm) (Ø body = 112,40 mm)		REF 144TA8278 (for rubber tracks) (number of teeth = 14) (number of holes = 9)	REF 143TA9537 (front, with bracket assembly) (for rubber tracks) (Ø = 450,00 mm)	REF 143TA9984 (rubber) (450 x 100 x 50)
REF 163TA9206 (for rubber tracks) (rear)				
TAKEUCHI TL20				
REF 163TA9284		REF 163TA9283	REF 163TA9282 (rear, with bracket assembly)	REF 163TA9285 (rubber) (350 x 90 x 44)
TAKEUCHI TL220				
REF 143TA9570 (for rubber tracks) (rear) (Ø flange = 228,00 mm) (Ø body = 88,00 mm)		REF 143TA9249 (for rubber tracks)	REF 143TA9569 (front, with bracket assembly) (for rubber tracks)	REF 163TA9190 (rubber) (320 x 86 x 46)
REF 143TA8830 (for rubber tracks) (Ø flange = 180,00 mm) (Ø body = 100,00 mm)				REF 143TA9985 (rubber) (320 x 86 x 46)
TAKEUCHI TL230				
REF 144TA7942 (for rubber tracks) (Ø flange = 166,00 mm) (Ø body = 137,00 mm)		REF 144TA8279 (for rubber tracks) (number of teeth = 16) (number of holes = 9)	REF 144TA8114 (front, with bracket assembly) (for rubber tracks) (Ø = 400,00 mm)	REF 143TA9713 (rubber) (320 x 86 x 52)
REF 163TA9205 (for rubber tracks) (rear)				
TAKEUCHI TL240				
REF 144TA8663 (for rubber tracks) (Ø flange = 216,10 mm) (Ø body = 112,40 mm)		REF 144TA8280 (for rubber tracks) (number of teeth = 14) (number of holes = 9)		REF 143TA9714 (rubber) (450 x 100 x 48)
REF 163TA9206 (for rubber tracks) (rear)		REF 164TA1518 (for rubber tracks) (number of teeth = 14) (number of holes = 9) (total height = 45,00 mm)		
TAKEUCHI TL250				
REF 144TA8664 (for rubber tracks) (Ø flange = 216,10 mm) (Ø body = 112,40 mm)		REF 144TA8281 (for rubber tracks) (number of teeth = 14) (number of holes = 9)		REF 163TA9189 (rubber) (450 x 100 x 50)
REF 163TA9206 (for rubber tracks) (rear)				
TAKEUCHI TL26				
<i>S/N: 02620002 - 02620023</i>				
REF 144TA7942 (Ø flange = 200,00 mm) (Ø body = 103,00 mm)		REF 163TA9195	REF 163TA9214 (rear, with bracket assembly) (Ø = 400,00 mm)	
<i>S/N: 02620024 - and up</i>				
REF 144TA7942 (Ø flange = 200,00 mm) (Ø body = 103,00 mm)		REF 163TA9196	REF 163TA9214 (rear, with bracket assembly) (Ø = 400,00 mm)	



USED FOR
TEREX



used for TEREX				
TRACK ROLLER	TOP ROLLER	SPROCKET	IDLER	TRACK
				
TEREX TC 16				
			REF 144TA9789 (wheel only) (for rubber tracks)	REF 164TA9681 (rubber) (230 x 48 x 66)
TEREX TC 20				
	REF 144TA9790 (assembly) (for rubber tracks) (Ø flange = 115,00 mm) (Ø body = 80,00 mm) REF 144TA9793 (assembly) (for steel tracks) (Ø flange = 98,00 mm) (Ø body = 80,00 mm)	REF 144TA9791 (for rubber tracks) (number of teeth = 19) (number of holes = 8) (total height = 23,40 mm) REF 144TA9794 (for steel tracks) (number of teeth = 19) (number of holes = 8) (total height = 23,40 mm)	REF 144TA9792 (wheel only) (for rubber tracks) REF 144TA9795 (wheel only) (for steel tracks)	REF 164TA9681 (rubber) (230 x 48 x 66)
TEREX TC 29				
REF 144TA9796 (for rubber tracks) (Ø flange = 133,00 mm) (Ø body = 95,00 mm) REF 144TA9799 (for steel tracks) (Ø flange = 115,00 mm) (Ø body = 95,00 mm)		REF 144TA9797 (for rubber tracks) (number of teeth = 21) (number of holes = 12) (total height = 26,00 mm) REF 144TA9800 (for steel tracks) (number of teeth = 21) (number of holes = 12) (total height = 26,00 mm)	REF 144TA9798 (wheel only) (for rubber tracks) (Ø = 311,00 mm) REF 144TA9801 (wheel only) (for steel tracks)	REF 143TA9618 (rubber) (300 x 55 x 72)
TEREX TC 35				
REF 144TA9802 (for rubber tracks) (Ø flange = 133,00 mm) (Ø body = 95,00 mm) REF 144TA9805 (for steel tracks) (Ø flange = 115,00 mm) (Ø body = 95,00 mm)		REF 144TA9803 (for rubber tracks) (number of teeth = 21) (number of holes = 12) (total height = 26,00 mm) REF 144TA9806 (for steel tracks) (number of teeth = 21) (number of holes = 12) (total height = 26,00 mm)	REF 144TA9804 (wheel only) (for rubber tracks) (Ø = 311,00 mm) REF 144TA9807 (wheel only) (for steel tracks)	REF 164TA9677 (rubber) (300 x 55 x 78)
TEREX TC 37				
REF 144TA9808 (for rubber tracks) (Ø flange = 133,00 mm) (Ø body = 95,00 mm) REF 144TA9811 (for steel tracks) (Ø flange = 115,00 mm) (Ø body = 95,00 mm)		REF 144TA9809 (for rubber tracks) (number of teeth = 21) (number of holes = 12) (total height = 26,00 mm) REF 144TA9812 (for steel tracks) (number of teeth = 21) (number of holes = 12) (total height = 26,00 mm)	REF 144TA9810 (wheel only) (for rubber tracks) (Ø = 311,00 mm) REF 144TA9813 (wheel only) (for steel tracks)	REF 164TA9679 (rubber) (300 x 52,5 x 86)
TEREX TC 48				
REF 144TA9814 (for rubber tracks) (outer guide) REF 144TA9817 (for steel tracks) (inner guide) (Ø flange = 140,00 mm) (Ø body = 110,00 mm)		REF 144TA9815 (for rubber tracks) (number of teeth = 19) (number of holes = 9) (total height = 49,50 mm) REF 144TA9818 (for steel tracks)	REF 144TA9816 (wheel only) (for rubber tracks) (Ø = 376,50 mm) REF 144TA9819 (wheel only) (for steel tracks) (Ø = 376,50 mm)	REF 164TA9683 (rubber) (400 x 72,5 x 72)
TEREX TC 50				
REF 144TA9820 (for rubber tracks) (Ø flange = 140,00 mm) (Ø body = 110,00 mm) REF 144TA9823 (for steel tracks) (Ø flange = 140,00 mm) (Ø body = 110,00 mm)		REF 144TA9821 (for rubber tracks) (number of teeth = 19) (number of holes = 9) (total height = 49,50 mm) REF 144TA9824 (for steel tracks)	REF 144TA9822 (wheel only) (for rubber tracks) (Ø = 376,50 mm) REF 144TA9825 (wheel only) (for steel tracks) (Ø = 376,50 mm)	REF 164TA9683 (rubber) (400 x 72,5 x 72)



used for TEREX				
TRACK ROLLER	TOP ROLLER	SPROCKET	IDLER	TRACK
				
TEREX TC 60				
<p>REF 144TA9826 (for rubber tracks) (Ø flange = 140,00 mm) (Ø body = 110,00 mm)</p> <p>REF 144TA9830 (for steel tracks) (Ø flange = 140,00 mm) (Ø body = 110,00 mm)</p>	<p>REF 144TA9827 (assembly) (for rubber tracks) (Ø flange = 115,00 mm) (Ø body = 95,00 mm)</p> <p>REF 144TA9831 (assembly) (for steel tracks) (Ø flange = 115,00 mm) (Ø body = 95,00 mm)</p>	<p>REF 144TA9828 (for rubber tracks) (number of teeth = 19) (number of holes = 9) (total height = 49,50 mm)</p> <p>REF 144TA9832 (for steel tracks)</p>	<p>REF 144TA9829 (wheel only) (for rubber tracks) (Ø = 376,50 mm)</p> <p>REF 144TA9833 (wheel only) (for steel tracks) (Ø = 376,50 mm)</p>	<p>REF 164TA9674 (rubber) (400 x 72,5 x 76)</p>
TEREX TC 75				
<p>REF 144TA9834 (for rubber tracks) (Ø flange = 155,00 mm) (Ø body = 121,00 mm)</p> <p>REF 144TA9837 (for steel tracks) (Ø flange = 155,00 mm) (Ø body = 121,00 mm)</p>		<p>REF 144TA9835 (for rubber tracks) (number of teeth = 23) (number of holes = 16) (total height = 38,00)</p> <p>REF 144TA9838 (for steel tracks)</p>	<p>REF 144TA9836 (wheel only) (for steel tracks)</p> <p>REF 144TA9839 (wheel only) (for steel tracks)</p>	<p>REF 164TA9676 (rubber) (450 x 71 x 86)</p>



USED FOR
VENIERI



used for VENIERI

used for VENIERI				
TRACK ROLLER	TOP ROLLER	SPROCKET	IDLER	TRACK
				
VENIERI VF141				
REF 144TA8665 (for rubber tracks)		REF 144TA8282 (for rubber tracks) (number of teeth = 14) (number of holes = 8)		REF 143TA9711 (rubber) (230 x 72 x 43)
VENIERI VF171				
REF 144TA8666 (for rubber tracks)		REF 144TA8283 (for rubber tracks) (number of teeth = 14) (number of holes = 8)		REF 143TA9711 (rubber) (230 x 72 x 43)



USED FOR
VOLVO

TRACKS & UNDERCARRIAGE PARTS



used for VOLVO

used for VOLVO				
TRACK ROLLER	TOP ROLLER	SPROCKET	IDLER	TRACK
				
VOLVO EC13 XR				
<i>S/P: 600 - S/N: 010151 - 040000</i>				
REF 144TA7300 (for rubber tracks) (Ø flange = 116,00 mm) (Ø body = 80,00 mm)	REF 144TA9693 (guide) (for rubber tracks) (plate type)	REF 144TA9688 (for rubber tracks) (number of teeth = 21) (number of holes = 8)	REF 144TA7304 (front, with bracket assembly) (for rubber tracks) (Ø = 272,00 mm)	REF 144TA9696 (rubber) (230 x 96 x 33) REF 144TA9689 (rubber) (230 x 96 x 33)
VOLVO EC13 XTV				
<i>S/P: 600 - S/N: 040151 - and up</i>				
REF 144TA7300 (for rubber tracks) (Ø flange = 116,00 mm) (Ø body = 80,00 mm)	REF 144TA9693 (guide) (for rubber tracks) (plate type)	REF 144TA9698 (for rubber tracks) (number of teeth = 21) (number of holes = 9)	REF 144TA7304 (front, with bracket assembly) (for rubber tracks) (Ø = 272,00 mm)	REF 144TA9696 (rubber) (230 x 96 x 33) REF 144TA9689 (rubber) (230 x 96 x 33)
VOLVO EC14				
<i>S/P: 246 - S/N: 021501 - and up</i>				
REF 144TA9676 (for rubber and steel tracks) (Ø flange = 129,50 mm) (Ø body = 68,00 mm)	REF 163TA9105 (guide) (for rubber and steel tracks) (skid type)	REF 144TA7308 (for rubber and steel tracks) (number of teeth = 14) (number of holes = 8)	REF 144TA9678 (front, with bracket assembly) (for rubber and steel tracks) (Ø = 287,00 mm)	REF 164TA2071 (steel) (width = 230,00 mm)
<i>S/P: 271 - S/N: 010151 - 021500</i>				
REF 144TA9676 (for rubber and steel tracks) (Ø flange = 129,50 mm) (Ø body = 68,00 mm)	REF 163TA9105 (guide) (for rubber and steel tracks) (skid type)	REF 144TA7308 (for rubber and steel tracks) (number of teeth = 14) (number of holes = 8)	REF 144TA9678 (front, with bracket assembly) (for rubber and steel tracks) (Ø = 287,00 mm)	REF 144TA9697 (rubber) (230 x 72 x 43) REF 164TA2071 (steel) (width = 230,00 mm)
VOLVO EC15 XR				
<i>S/P: 265 - S/N: 010151 - 014000</i>				
REF 144TA9676 (for rubber and steel tracks) (Ø flange = 129,50 mm) (Ø body = 68,00 mm)	REF 163TA9105 (guide) (for rubber and steel tracks) (skid type)	REF 144TA7308 (for rubber and steel tracks) (number of teeth = 14) (number of holes = 8)	REF 144TA9678 (front, with bracket assembly) (for rubber and steel tracks) (Ø = 287,00 mm)	REF 144TA9697 (rubber) (230 x 72 x 43) REF 164TA2071 (steel) (width = 230,00 mm)
<i>S/P: 265 - S/N: 014010 - and up</i>				
REF 144TA9676 (for rubber and steel tracks) (Ø flange = 129,50 mm) (Ø body = 68,00 mm)	REF 163TA9105 (guide) (for rubber and steel tracks) (skid type)	REF 144TA7308 (for rubber and steel tracks) (number of teeth = 14) (number of holes = 8)	REF 144TA9678 (front, with bracket assembly) (for rubber and steel tracks) (Ø = 287,00 mm)	REF 144TA9697 (rubber) (230 x 72 x 43) REF 164TA2071 (steel) (width = 230,00 mm)
VOLVO EC15 XT				
<i>S/P: 261 - S/N: 010151 - and up</i>				
REF 163TA9100 (for rubber tracks) (Ø flange = 116,00 mm) (Ø body = 80,00 mm) REF 144TA7305 (for steel tracks) (Ø flange = 100,00 mm) (Ø body = 80,00 mm)	REF 144TA9693 (guide) (for rubber and steel tracks) (plate type)	REF 144TA9698 (for rubber and steel tracks) (number of teeth = 21) (number of holes = 9)	REF 144TA7304 (front, with bracket assembly) (for rubber tracks) (Ø = 272,00 mm) REF 144TA9677 (front, with bracket assembly) (for steel tracks)	REF 144TA9696 (rubber) (230 x 96 x 33) REF 163TA9091 (steel) (width = 230,00 mm)

TRACKS & UNDERCARRIAGE PARTS



used for VOLVO

used for VOLVO				
TRACK ROLLER	TOP ROLLER	SPROCKET	IDLER	TRACK
				
VOLVO EC15 XTV				
<i>S/P: 261 - S/N: 010151 - and up</i>				
REF 163TA9100 (for rubber tracks) (Ø flange = 116,00 mm) (Ø body = 80,00 mm)	REF 144TA9693 (guide) (for rubber and steel tracks) (plate type)	REF 144TA9698 (for rubber and steel tracks) (number of teeth = 21) (number of holes = 9)	REF 144TA7304 (front, with bracket assembly) (for rubber tracks) (Ø = 272,00 mm)	REF 144TA9696 (rubber) (230 x 96 x 33)
REF 144TA7305 (for steel tracks) (Ø flange = 100,00 mm) (Ø body = 80,00 mm)			REF 144TA9677 (front, with bracket assembly) (for steel tracks)	REF 163TA9091 (steel) (width = 230,00 mm)
VOLVO EC15B				
REF 144TA7300 (for rubber tracks) (Ø flange = 116,00 mm) (Ø body = 80,00 mm)	REF 144TA7285 (assembly) (for rubber and steel tracks) (Ø flange = 108,00 mm) (Ø body = 93,00 mm)	REF 144TA7299 (for rubber and steel tracks) (number of teeth = 21) (number of holes = 9)	REF 144TA7304 (front, with bracket assembly) (for rubber tracks) (Ø = 272,00 mm)	REF 144TA9689 (rubber) (230 x 96 x 33)
REF 144TA7305 (for steel tracks) (Ø flange = 100,00 mm) (Ø body = 80,00 mm)			REF 144TA7280 (front, with bracket assembly) (for steel tracks)	
VOLVO EC15B XR				
<i>S/P: 272 - S/N: 010151 - 011461</i>				
REF 144TA9676 (for rubber tracks) (Ø flange = 129,50 mm) (Ø body = 68,00 mm)	REF 163TA9105 (guide) (for rubber tracks) (skid type)	REF 144TA7308 (for rubber tracks) (number of teeth = 14) (number of holes = 8)	REF 144TA9678 (front, with bracket assembly) (for rubber tracks) (Ø = 287,00 mm)	REF 144TA9697 (rubber) (230 x 72 x 43)
<i>S/P: 272 - S/N: 011462 - and up</i>				
REF 144TA7300 (for rubber tracks) (Ø flange = 116,00 mm) (Ø body = 80,00 mm)	REF 144TA9693 (guide) (for rubber tracks) (plate type)	REF 144TA9688 (for rubber tracks) (number of teeth = 21) (number of holes = 8)	REF 144TA7304 (front, with bracket assembly) (for rubber tracks) (Ø = 272,00 mm)	REF 144TA9696 (rubber) (230 x 96 x 33)
VOLVO EC15B XT				
<i>S/P: 272 - S/N: 025151 - 040000</i>				
REF 163TA9100 (for rubber tracks) (Ø flange = 116,00 mm) (Ø body = 80,00 mm)	REF 144TA9693 (guide) (for rubber and steel tracks) (plate type)	REF 144TA9698 (for rubber and steel tracks) (number of teeth = 21) (number of holes = 9)	REF 144TA7304 (front, with bracket assembly) (for rubber tracks) (Ø = 272,00 mm)	REF 144TA9696 (rubber) (230 x 96 x 33)
REF 144TA7305 (for steel tracks) (Ø flange = 100,00 mm) (Ø body = 80,00 mm)			REF 144TA9677 (front, with bracket assembly) (for steel tracks)	REF 163TA9091 (steel) (width = 230,00 mm)
VOLVO EC15B XTV				
<i>S/P: 272 - S/N: 040151 - and up</i>				
REF 163TA9100 (for rubber tracks) (Ø flange = 116,00 mm) (Ø body = 80,00 mm)	REF 144TA9693 (guide) (for rubber and steel tracks) (plate type)	REF 144TA9698 (for rubber and steel tracks) (number of teeth = 21) (number of holes = 9)	REF 144TA7304 (front, with bracket assembly) (for rubber tracks) (Ø = 272,00 mm)	REF 144TA9696 (rubber) (230 x 96 x 33)
REF 144TA7305 (for steel tracks) (Ø flange = 100,00 mm) (Ø body = 80,00 mm)			REF 144TA9677 (front, with bracket assembly) (for steel tracks)	REF 163TA9091 (steel) (width = 230,00 mm)
VOLVO EC15C				
<i>S/N: 001533 - and up</i>				
REF 144TA7300 (for rubber tracks) (Ø flange = 116,00 mm) (Ø body = 80,00 mm)	REF 144TA9693 (guide) (for rubber tracks) (plate type)	REF 144TA7293 (for rubber tracks) (number of teeth = 23) (number of holes = 9)	REF 144TA9724 (front, with bracket assembly) (for rubber tracks) (Ø = 272,00 mm)	REF 144TA9723 (rubber) (230 x 96 x 33)



used for VOLVO

used for VOLVO				
TRACK ROLLER	TOP ROLLER	SPROCKET	IDLER	TRACK
				
VOLVO EC15D				
<i>S/N: 001502 - and up</i>				
		REF 144TA9698 (number of teeth = 21) (number of holes = 9)		
VOLVO EC17C				
<i>S/N: 001737 - and up</i>				
REF 144TA7300 (for rubber tracks) (Ø flange = 116,00 mm) (Ø body = 80,00 mm)	REF 144TA9693 (guide) (for rubber tracks) (plate type)	REF 144TA7293 (for rubber tracks) (number of teeth = 23) (number of holes = 9)	REF 144TA9724 (front, with bracket assembly) (for rubber tracks) (Ø = 272,00 mm)	REF 144TA9723 (rubber) (230 x 96 x 33)
VOLVO EC18C				
<i>S/N: 001839 - and up</i>				
REF 144TA7300 (for rubber tracks) (Ø flange = 116,00 mm) (Ø body = 80,00 mm)	REF 144TA9693 (guide) (for rubber tracks) (plate type)	REF 144TA7293 (for rubber tracks) (number of teeth = 23) (number of holes = 9)	REF 144TA9724 (front, with bracket assembly) (for rubber tracks) (Ø = 272,00 mm)	REF 144TA9723 (rubber) (230 x 96 x 33)
VOLVO EC18D				
<i>S/N: 001805 - and up</i>				
		REF 144TA9698 (number of teeth = 21) (number of holes = 9)		
VOLVO EC20 XT				
<i>S/P: 263 - S/N: 010151 - and up</i>				
REF 144TA7305 (for steel tracks) (Ø flange = 100,00 mm) (Ø body = 80,00 mm)	REF 144TA9693 (guide) (for rubber and steel tracks) (plate type)	REF 144TA9698 (for rubber and steel tracks) (number of teeth = 21) (number of holes = 9)	REF 144TA7304 (front, with bracket assembly) (for rubber tracks) (Ø = 272,00 mm)	REF 144TA9695 (rubber) (250 x 96 x 36)
REF 163TA9100 (for rubber tracks) (Ø flange = 116,00 mm) (Ø body = 80,00 mm)			REF 144TA9677 (front, with bracket assembly) (for steel tracks)	REF 163TA9089 (steel) (width = 230,00 mm)
VOLVO EC20 XTV				
<i>S/P: 263 - S/N: 010151 - and up</i>				
REF 163TA9100 (for rubber tracks) (Ø flange = 116,00 mm) (Ø body = 80,00 mm)	REF 144TA9693 (guide) (for rubber and steel tracks) (plate type)	REF 144TA9698 (for rubber and steel tracks) (number of teeth = 21) (number of holes = 9)	REF 144TA7304 (front, with bracket assembly) (for rubber tracks) (Ø = 272,00 mm)	REF 144TA9695 (rubber) (250 x 96 x 36)
REF 144TA7305 (for steel tracks) (Ø flange = 100,00 mm) (Ø body = 80,00 mm)			REF 144TA9677 (front, with bracket assembly) (for steel tracks)	REF 163TA9089 (steel) (width = 230,00 mm)
VOLVO EC20B				
REF 144TA7300 (for rubber tracks) (Ø flange = 116,00 mm) (Ø body = 80,00 mm)		REF 144TA7299 (for rubber and steel tracks) (number of teeth = 21) (number of holes = 9)	REF 144TA7304 (front, with bracket assembly) (for rubber tracks) (Ø = 272,00 mm)	REF 163TA9258 (rubber) (250 x 96 x 36)
REF 144TA7305 (for steel tracks) (Ø flange = 100,00 mm) (Ø body = 80,00 mm)			REF 144TA7281 (front, with bracket assembly) (for steel tracks)	
VOLVO EC20B XT				
<i>S/P: 272 - S/N: 060151 - 080000</i>				
REF 163TA9100 (for rubber tracks) (Ø flange = 116,00 mm) (Ø body = 80,00 mm)	REF 144TA9693 (guide) (for rubber and steel tracks) (plate type)	REF 144TA9698 (for rubber and steel tracks) (number of teeth = 21) (number of holes = 9)	REF 144TA7304 (front, with bracket assembly) (for rubber tracks) (Ø = 272,00 mm)	REF 144TA9695 (rubber) (250 x 96 x 36)



used for VOLVO				
TRACK ROLLER	TOP ROLLER	SPROCKET	IDLER	TRACK
				
REF 144TA7305 (for steel tracks) (Ø flange = 100,00 mm) (Ø body = 80,00 mm)			REF 144TA9677 (front, with bracket assembly) (for steel tracks)	REF 163TA9089 (steel) (width = 230,00 mm)
VOLVO EC20B XTV S/P: 272 - S/N: 080151 - and up				
REF 163TA9100 (for rubber tracks) (Ø flange = 116,00 mm) (Ø body = 80,00 mm)	REF 144TA9693 (guide) (for rubber and steel tracks) (plate type)	REF 144TA9698 (for rubber and steel tracks) (number of teeth = 21) (number of holes = 9)	REF 144TA7304 (front, with bracket assembly) (for rubber tracks) (Ø = 272,00 mm)	REF 144TA9695 (rubber) (250 x 96 x 36)
REF 144TA7305 (for steel tracks) (Ø flange = 100,00 mm) (Ø body = 80,00 mm)			REF 144TA9677 (front, with bracket assembly) (for steel tracks)	REF 163TA9089 (steel) (width = 230,00 mm)
VOLVO EC20C S/N: 002038 - and up				
REF 144TA7300 (for rubber tracks) (Ø flange = 116,00 mm) (Ø body = 80,00 mm)	REF 144TA9693 (guide) (for rubber tracks) (plate type)	REF 144TA9698 (for rubber tracks) (number of teeth = 21) (number of holes = 9)	REF 144TA9724 (front, with bracket assembly) (for rubber tracks) (Ø = 272,00 mm)	REF 144TA9695 (rubber) (250 x 96 x 36)
VOLVO EC20D S/N: 002002 - and up				
		REF 144TA9698 (number of teeth = 21) (number of holes = 9)		
VOLVO EC25 S/P: 281 - S/N: 010151 - and up				
REF 144TA9702 (for rubber tracks) (Ø flange = 130,00 mm) (Ø body = 95,00 mm)	REF 144TA9703 (assembly) (for rubber and steel tracks) (Ø body = 80,00 mm)	REF 144TA7293 (for rubber and steel tracks) (number of teeth = 23) (number of holes = 9)	REF 144TA9718 (front, with bracket assembly) (for rubber and steel tracks) (Ø = 338,00 mm)	REF 164TA2047 (rubber) (300 x 109w x 38)
REF 144TA9721 (for steel tracks) (Ø flange = 119,00 mm) (Ø body = 95,00 mm)				REF 163TA9090 (steel) (width = 300,00 mm)
VOLVO EC27C S/N: 002742 - and up				
REF 144TA9702 (for rubber tracks) (Ø flange = 130,00 mm) (Ø body = 95,00 mm)	REF 144TA9703 (assembly) (for rubber tracks) (Ø body = 80,00 mm)	REF 144TA7293 (for rubber tracks) (number of teeth = 23) (number of holes = 9)	REF 144TA9720 (front, with bracket assembly) (for rubber tracks)	REF 144TA9690 (rubber) (250 x 109 x 38)
				REF 144TA9692 (rubber) (300 x 109w x 38)
VOLVO EC30 S/P: 282 - S/N: 010151 - and up				
REF 144TA9702 (for rubber tracks) (Ø flange = 130,00 mm) (Ø body = 95,00 mm)	REF 144TA9703 (assembly) (for rubber and steel tracks) (Ø body = 80,00 mm)	REF 144TA7293 (for rubber and steel tracks) (number of teeth = 23) (number of holes = 9)	REF 144TA9718 (front, with bracket assembly) (for rubber and steel tracks) (Ø = 338,00 mm)	REF 144TA9692 (rubber) (300 x 109w x 38)
REF 144TA9721 (for steel tracks) (Ø flange = 119,00 mm) (Ø body = 95,00 mm)				REF 163TA9090 (steel) (width = 300,00 mm)



used for VOLVO				
TRACK ROLLER	TOP ROLLER	SPROCKET	IDLER	TRACK
				
VOLVO EC35				
<i>S/P: 283 - S/N: 010151 - and up</i>				
REF 144TA9702 (for rubber tracks) (Ø flange = 130,00 mm) (Ø body = 95,00 mm)	REF 144TA9703 (assembly) (for rubber and steel tracks) (Ø body = 80,00 mm)	REF 144TA7310 (for rubber and steel tracks) (number of teeth = 23) (number of holes = 12)	REF 144TA9718 (front, with bracket assembly) (for rubber and steel tracks)	REF 144TA9691 (rubber) (300 x 109w x 41)
REF 144TA9721 (for steel tracks) (Ø flange = 119,00 mm) (Ø body = 95,00 mm)				REF 163TA9092 (steel) (width = 300,00 mm) (number of links = 43)
VOLVO EC35C				
<i>S/N: 003538 - and up</i>				
REF 144TA9702 (for rubber tracks) (Ø flange = 130,00 mm) (Ø body = 95,00 mm)	REF 144TA9703 (assembly) (for rubber and steel tracks) (Ø body = 80,00 mm)	REF 144TA7310 (for rubber and steel tracks) (number of teeth = 23) (number of holes = 12)	REF 144TA9718 (front, with bracket assembly) (for rubber tracks) (Ø = 338,00 mm)	REF 144TA9700 (rubber) (300 x 52,5w x 84)
REF 144TA9721 (for steel tracks) (Ø flange = 119,00 mm) (Ø body = 95,00 mm)			REF 144TA9722 (front, with bracket assembly) (for steel tracks) (complete with tensioner)	REF 163TA9092 (steel) (width = 300,00 mm) (number of links = 43)
VOLVO EC45				
<i>S/P: 284 - S/N: 010151 - 017150</i>				
REF 144TA7289 (for rubber and steel tracks) (Ø flange = 140,00 mm) (Ø body = 110,00 mm)	REF 144TA9719 (assembly) (for rubber and steel tracks) (Ø body = 80,00 mm)	REF 144TA7287 (for rubber and steel tracks) (number of teeth = 19) (number of holes = 9)	REF 144TA7303 (front, with bracket assembly) (for rubber and steel tracks) (Ø = 375,00 mm)	REF 144TA9694 (rubber) (400 x 72,5w x 68)
				REF 163TA9093 (steel) (width = 400,00 mm)
VOLVO EC45 PRO				
<i>S/P: 284 - S/N: 017151 - and up</i>				
REF 144TA7289 (for rubber and steel tracks) (Ø flange = 140,00 mm) (Ø body = 110,00 mm)	REF 144TA9719 (assembly) (for rubber and steel tracks) (Ø body = 80,00 mm)	REF 144TA7287 (for rubber and steel tracks) (number of teeth = 19) (number of holes = 9)	REF 144TA7303 (front, with bracket assembly) (for rubber and steel tracks) (Ø = 375,00 mm)	REF 144TA9694 (rubber) (400 x 72,5w x 68)
				REF 163TA9093 (steel) (width = 400,00 mm)
VOLVO EC50				
<i>S/P: 247 - S/N: 010151 - and up</i>				
REF 144TA7301 (for rubber and steel tracks) (Ø flange = 155,00 mm) (Ø body = 121,00 mm)	REF 144TA9664 (guide) (for rubber and steel tracks) (plate type)	REF 144TA9666 (for rubber and steel tracks)	REF 144TA9673 (front, with bracket assembly) (for rubber and steel tracks) (Ø = 408,00 mm)	REF 144TA9670 (rubber) (400 x 72,5w x 70)
				REF 163TA9094 (steel) (width = 400,00 mm)
				REF 163TA9095 (steel) (width = 450,00 mm)
				REF 163TA9096 (steel) (width = 500,00 mm)
VOLVO EC50 VV				
<i>S/P: 247 - S/N: 010151 - and up</i>				
REF 144TA7301 (for rubber and steel tracks) (Ø flange = 155,00 mm) (Ø body = 121,00 mm)	REF 144TA9664 (guide) (for rubber and steel tracks) (plate type)	REF 144TA9666 (for rubber and steel tracks)	REF 144TA9673 (front, with bracket assembly) (for rubber and steel tracks) (Ø = 408,00 mm)	REF 144TA9670 (rubber) (400 x 72,5w x 70)



used for VOLVO				
TRACK ROLLER	TOP ROLLER	SPROCKET	IDLER	TRACK
				
				REF 163TA9094 (steel) (width = 400,00 mm) REF 163TA9095 (steel) (width = 450,00 mm) REF 163TA9096 (steel) (width = 500,00 mm)
VOLVO EC55				
<i>S/N: 003001 - 005000</i>				
REF 144TA7286 (for rubber and steel tracks) (double guide) (∅ flange = 139,00 mm) (∅ body = 129,00 mm) REF 144TA9713 (for rubber and steel tracks) (outer guide) (∅ flange = 130,00 mm) (∅ body = 105,00 mm)	REF 144TA7285 (assembly) (for rubber and steel tracks) (∅ flange = 108,00 mm) (∅ body = 93,00 mm)	REF 144TA7288 (for rubber and steel tracks) (number of holes = 12)	REF 144TA9711 (front, with bracket assembly) (for rubber tracks) (∅ = 372,00 mm) REF 144TA7309 (front, with bracket assembly) (for steel tracks) (∅ = 372,00 mm)	REF 163TA9087 (rubber) (400 x 72,5w x 74)
VOLVO EC55-2				
<i>S/N: 005001 - 007620</i>				
REF 144TA7286 (for rubber and steel tracks) (double guide) (∅ flange = 139,00 mm) (∅ body = 129,00 mm) REF 144TA9713 (for rubber and steel tracks) (outer guide) (∅ flange = 130,00 mm) (∅ body = 105,00 mm)	REF 144TA7285 (assembly) (for rubber and steel tracks) (∅ flange = 108,00 mm) (∅ body = 93,00 mm)	REF 144TA7288 (for rubber and steel tracks) (number of holes = 12)	REF 144TA9711 (front, with bracket assembly) (for rubber tracks) (∅ = 372,00 mm) REF 144TA7309 (front, with bracket assembly) (for steel tracks) (∅ = 372,00 mm)	REF 163TA9087 (rubber) (400 x 72,5w x 74)
VOLVO EC55B				
<i>S/P: CHN - S/N: 050001 - and up</i>				
REF 144TA9713 (for rubber and steel tracks) (outer guide) (∅ flange = 130,00 mm) (∅ body = 105,00 mm) REF 144TA7286 (for rubber and steel tracks) (double guide) (∅ flange = 139,00 mm) (∅ body = 129,00 mm)	REF 144TA9710 (assembly) (for rubber and steel tracks) (∅ flange = 108,00 mm) (∅ body = 93,00 mm)	REF 144TA7288 (for rubber and steel tracks) (number of holes = 12)	REF 144TA9711 (front, with bracket assembly) (for rubber tracks) (∅ = 372,00 mm) REF 144TA7309 (front, with bracket assembly) (for rubber and steel tracks) (∅ = 372,00 mm)	REF 144TA9715 (rubber) (400 x 72,5w x 74)
<i>S/P: KOR - S/N: 030001 - 033331</i>				
REF 144TA9713 (for rubber and steel tracks) (outer guide) (∅ flange = 130,00 mm) (∅ body = 105,00 mm) REF 144TA7286 (for rubber and steel tracks) (double guide) (∅ flange = 139,00 mm) (∅ body = 129,00 mm)	REF 144TA7285 (assembly) (for rubber and steel tracks) (∅ flange = 108,00 mm) (∅ body = 93,00 mm)	REF 144TA7288 (for rubber and steel tracks) (number of holes = 12)	REF 144TA9711 (front, with bracket assembly) (for rubber tracks) (∅ = 372,00 mm) REF 144TA7309 (front, with bracket assembly) (for rubber and steel tracks) (∅ = 372,00 mm)	REF 144TA9715 (rubber) (400 x 72,5w x 74)
<i>S/P: KOR - S/N: 033332 - and up</i>				
REF 144TA9713 (for rubber and steel tracks) (outer guide) (∅ flange = 130,00 mm) (∅ body = 105,00 mm)	REF 144TA9710 (assembly) (for rubber and steel tracks) (∅ flange = 108,00 mm) (∅ body = 93,00 mm)	REF 144TA7288 (for rubber and steel tracks) (number of holes = 12)	REF 144TA9711 (front, with bracket assembly) (for rubber tracks) (∅ = 372,00 mm)	



used for VOLVO

used for VOLVO				
TRACK ROLLER	TOP ROLLER	SPROCKET	IDLER	TRACK
				
REF 144TA7286 (for rubber and steel tracks) (double guide) (Ø flange = 139,00 mm) (Ø body = 129,00 mm)			REF 144TA7309 (front, with bracket assembly) (for rubber and steel tracks) (Ø = 372,00 mm)	
VOLVO EC55C				
<i>S/N: 110001 - 119999</i>				
REF 144TA7286 (for rubber and steel tracks) (double guide) (Ø flange = 139,00 mm) (Ø body = 129,00 mm)	REF 144TA9710 (assembly) (for rubber and steel tracks) (Ø flange = 108,00 mm) (Ø body = 93,00 mm)	REF 144TA7288 (for rubber and steel tracks) (number of holes = 12)	REF 144TA9711 (front, with bracket assembly) (for rubber tracks) (Ø = 372,00 mm)	REF 144TA9715 (rubber) (400 x 72,5w x 74)
REF 144TA9713 (for rubber and steel tracks) (outer guide) (Ø flange = 130,00 mm) (Ø body = 105,00 mm)			REF 144TA7309 (front, with bracket assembly) (for rubber and steel tracks) (Ø = 372,00 mm)	
<i>S/N: 120001 - and up</i>				
REF 144TA7286 (for rubber and steel tracks) (double guide) (Ø flange = 139,00 mm) (Ø body = 129,00 mm)	REF 144TA9710 (assembly) (for rubber and steel tracks) (Ø flange = 108,00 mm) (Ø body = 93,00 mm)	REF 144TA7288 (for rubber and steel tracks) (number of holes = 12)	REF 144TA9711 (front, with bracket assembly) (for rubber tracks) (Ø = 372,00 mm)	REF 144TA9715 (rubber) (400 x 72,5w x 74)
REF 144TA9713 (for rubber and steel tracks) (outer guide) (Ø flange = 130,00 mm) (Ø body = 105,00 mm)			REF 144TA7309 (front, with bracket assembly) (for rubber and steel tracks) (Ø = 372,00 mm)	
VOLVO EC55-EU				
<i>S/N: 020001 - 021355</i>				
REF 144TA7286 (for rubber and steel tracks) (double guide) (Ø flange = 139,00 mm) (Ø body = 129,00 mm)	REF 144TA7285 (assembly) (for rubber and steel tracks) (Ø flange = 108,00 mm) (Ø body = 93,00 mm)	REF 144TA7288 (for rubber and steel tracks) (number of holes = 12)	REF 144TA9711 (front, with bracket assembly) (for rubber tracks) (Ø = 372,00 mm)	REF 163TA9087 (rubber) (400 x 72,5w x 74)
REF 144TA9713 (for rubber and steel tracks) (outer guide) (Ø flange = 130,00 mm) (Ø body = 105,00 mm)			REF 144TA7309 (front, with bracket assembly) (for steel tracks) (Ø = 372,00 mm)	
VOLVO EC60C				
<i>S/N: 110001 - and up</i>				
REF 144TA9713 (for rubber and steel tracks) (outer guide) (Ø flange = 130,00 mm) (Ø body = 105,00 mm)	REF 144TA9710 (assembly) (for rubber and steel tracks) (Ø flange = 108,00 mm) (Ø body = 93,00 mm)	REF 144TA7288 (for rubber and steel tracks) (number of holes = 12)	REF 144TA7309 (front, with bracket assembly) (for rubber and steel tracks) (Ø = 372,00 mm)	REF 144TA9715 (rubber) (400 x 72,5w x 74)
REF 144TA7286 (for rubber and steel tracks) (double guide) (Ø flange = 139,00 mm) (Ø body = 129,00 mm)			REF 144TA9711 (front, with bracket assembly) (for rubber tracks) (Ø = 372,00 mm)	
VOLVO EC70				
<i>S/P: 233 - S/N: 010151 - 011250</i>				
REF 144TA7301 (for rubber and steel tracks) (outer guide) (Ø flange = 155,00 mm) (Ø body = 121,00 mm)	REF 144TA9664 (guide) (for rubber and steel tracks) (plate type)	REF 144TA9668 (for rubber tracks)	REF 144TA9674 (front, with bracket assembly) (for rubber tracks)	REF 144TA9672 (rubber) (450 x 71 x 80)



used for VOLVO				
TRACK ROLLER	TOP ROLLER	SPROCKET	IDLER	TRACK
				
REF 144TA9675 (for rubber tracks) (inner guide) (Ø flange = 188,00 mm) (Ø body = 135,00 mm)		REF 144TA7306 (for steel tracks)	REF 144TA9673 (front, with bracket assembly) (for steel tracks) (Ø = 408,00 mm)	REF 163TA9097 (steel) (width = 450,00 mm) (number of links = 40) REF 163TA9098 (steel) (width = 600,00 mm)
<i>S/P: 233 - S/N: 011251 - and up</i>				
REF 144TA7301 (for rubber and steel tracks) (outer guide) (Ø flange = 155,00 mm) (Ø body = 121,00 mm)	REF 144TA7291 (assembly) (for rubber and steel tracks) (Ø flange = 120,00 mm) (Ø body = 90,70 mm)	REF 144TA9667 (for rubber tracks) (number of teeth = 23) (number of holes = 12)	REF 144TA9674 (front, with bracket assembly) (for rubber tracks)	REF 144TA9672 (rubber) (450 x 71 x 80)
REF 144TA9675 (for rubber tracks) (inner guide) (Ø flange = 188,00 mm) (Ø body = 135,00 mm)		REF 144TA9669 (for steel tracks)	REF 144TA9673 (front, with bracket assembly) (for steel tracks) (Ø = 408,00 mm)	REF 163TA9097 (steel) (width = 450,00 mm) (number of links = 40) REF 163TA9098 (steel) (width = 600,00 mm)
VOLVO EC70 VV				
<i>S/P: 233 - S/N: 010151 - and up</i>				
REF 144TA9675 (for rubber tracks) (inner guide) (Ø flange = 188,00 mm) (Ø body = 135,00 mm)	REF 144TA7291 (assembly) (for rubber and steel tracks) (Ø flange = 120,00 mm) (Ø body = 90,70 mm)	REF 144TA9667 (for rubber tracks) (number of teeth = 23) (number of holes = 12)	REF 144TA9674 (front, with bracket assembly) (for rubber tracks)	REF 144TA9672 (rubber) (450 x 71 x 80)
REF 144TA7301 (for rubber and steel tracks) (outer guide) (Ø flange = 155,00 mm) (Ø body = 121,00 mm)		REF 144TA9669 (for steel tracks)	REF 144TA9673 (front, with bracket assembly) (for steel tracks) (Ø = 408,00 mm)	
VOLVO EC80D				
<i>S/N: 210001 - 230000</i>				
REF 163TA9104 (for steel tracks)	REF 144TA9716 (assembly) (for steel tracks) (Ø flange = 125,00 mm) (Ø body = 100,00 mm)	REF 144TA9705 (for steel tracks) (number of teeth = 21) (number of holes = 12)	REF 163TA9110 (front, with bracket assembly) (for steel tracks)	
<i>S/N: 230001 - and up</i>				
REF 163TA9104 (for steel tracks)	REF 144TA9716 (assembly) (for steel tracks) (Ø flange = 125,00 mm) (Ø body = 100,00 mm)	REF 144TA9705 (for steel tracks) (number of teeth = 21) (number of holes = 12)	REF 163TA9110 (front, with bracket assembly) (for steel tracks)	
VOLVO ECR25D				
<i>S/N: 002507 - and up</i>				
REF 144TA9702 (for rubber tracks) (Ø flange = 130,00 mm) (Ø body = 95,00 mm)	REF 144TA9703 (assembly) (for rubber tracks) (Ø body = 80,00 mm)	REF 144TA7293 (for rubber tracks) (number of teeth = 23) (number of holes = 9)	REF 144TA9718 (front, with bracket assembly) (for rubber tracks) (Ø = 338,00 mm)	REF 144TA9690 (rubber) (250 x 109 x 38) REF 144TA9692 (rubber) (300 x 109w x 38)
VOLVO ECR28				
<i>S/P: 601 - S/N: 010151 - and up</i>				
REF 144TA9702 (for rubber tracks) (Ø flange = 130,00 mm) (Ø body = 95,00 mm)	REF 144TA9703 (assembly) (for rubber and steel tracks) (Ø body = 80,00 mm)	REF 144TA7293 (for rubber and steel tracks) (number of teeth = 23) (number of holes = 9)	REF 144TA9718 (front, with bracket assembly) (for rubber and steel tracks) (Ø = 338,00 mm)	REF 144TA9690 (rubber) (250 x 109 x 38)



used for VOLVO

used for VOLVO				
TRACK ROLLER	TOP ROLLER	SPROCKET	IDLER	TRACK
				
REF 144TA9721 (for steel tracks) (Ø flange = 119,00 mm) (Ø body = 95,00 mm)				REF 144TA9692 (rubber) (300 x 109w x 38)
VOLVO ECR38				
<i>S/P: 602 - S/N: 010151 - and up</i>				
REF 144TA9702 (for rubber tracks) (Ø flange = 130,00 mm) (Ø body = 95,00 mm)	REF 144TA9703 (assembly) (for rubber and steel tracks) (Ø body = 80,00 mm)	REF 144TA7310 (for rubber and steel tracks) (number of teeth = 23) (number of holes = 12)	REF 144TA9718 (front, with bracket assembly) (for rubber and steel tracks) (Ø = 338,00 mm)	REF 144TA9691 (rubber) (300 x 109w x 41)
REF 144TA9721 (for steel tracks) (Ø flange = 119,00 mm) (Ø body = 95,00 mm)				REF 144TA9700 (rubber) (300 x 52,5w x 84)
VOLVO ECR40D				
				REF 163TA9088 (rubber) (300 x 52,5w x 84)
VOLVO ECR48C				
<i>S/N: 004838 - and up</i>				
REF 144TA7286 (for rubber tracks) (double guide) (Ø flange = 139,00 mm) (Ø body = 129,00 mm)	REF 144TA9710 (assembly) (for rubber and steel tracks) (Ø flange = 108,00 mm) (Ø body = 93,00 mm)	REF 144TA9699 (for rubber and steel tracks)	REF 144TA9711 (front, with bracket assembly) (for rubber tracks) (Ø = 372,00 mm)	REF 144TA9701 (rubber) (400 x 72,5w x 72)
REF 144TA9713 (for rubber and steel tracks) (outer guide) (Ø flange = 130,00 mm) (Ø body = 105,00 mm)			REF 144TA7309 (front, with bracket assembly) (for steel tracks) (Ø = 372,00 mm)	
VOLVO ECR50D				
<i>S/N: 005038 - and up</i>				
REF 144TA7286 (for rubber tracks) (double guide) (Ø flange = 139,00 mm) (Ø body = 129,00 mm)	REF 144TA9710 (assembly) (for rubber and steel tracks) (Ø flange = 108,00 mm) (Ø body = 93,00 mm)	REF 144TA9699 (for rubber and steel tracks)	REF 164TA2149 (front, with bracket assembly) (for rubber tracks) (Ø = 372,00 mm)	REF 163TA9084 (rubber) (400 x 72,5w x 74)
REF 144TA9713 (for rubber and steel tracks) (outer guide) (Ø flange = 130,00 mm) (Ø body = 105,00 mm)			REF 163TA9106 (front, with bracket assembly) (for steel tracks) (Ø = 372,00 mm)	
VOLVO ECR58				
<i>S/N: 010001 - 010135</i>				
REF 144TA7286 (for rubber tracks) (double guide) (Ø flange = 139,00 mm) (Ø body = 129,00 mm)	REF 144TA7285 (assembly) (for rubber and steel tracks) (Ø flange = 108,00 mm) (Ø body = 93,00 mm)	REF 144TA9704 (for rubber and steel tracks)	REF 144TA9711 (front, with bracket assembly) (for rubber tracks) (Ø = 372,00 mm)	REF 144TA9715 (rubber) (400 x 72,5w x 74)
REF 144TA9713 (for rubber and steel tracks) (outer guide) (Ø flange = 130,00 mm) (Ø body = 105,00 mm)			REF 144TA7309 (front, with bracket assembly) (for steel tracks) (Ø = 372,00 mm)	
<i>S/N: 010136 - and up</i>				
REF 144TA7286 (for rubber tracks) (double guide) (Ø flange = 139,00 mm) (Ø body = 129,00 mm)	REF 144TA9710 (assembly) (for rubber and steel tracks) (Ø flange = 108,00 mm) (Ø body = 93,00 mm)	REF 144TA9704 (for rubber and steel tracks)	REF 144TA9711 (front, with bracket assembly) (for rubber tracks) (Ø = 372,00 mm)	REF 144TA9715 (rubber) (400 x 72,5w x 74)



used for VOLVO				
TRACK ROLLER	TOP ROLLER	SPROCKET	IDLER	TRACK
				
REF 144TA9713 (for rubber and steel tracks) (outer guide) (∅ flange = 130,00 mm) (∅ body = 105,00 mm)			REF 144TA7309 (front, with bracket assembly) (for steel tracks) (∅ = 372,00 mm)	
VOLVO ECR58D				
S/N: 210001 - 028000				
REF 163TA9102 (for rubber tracks) (inner guide)	REF 144TA9710 (assembly) (for rubber and steel tracks) (∅ flange = 108,00 mm) (∅ body = 93,00 mm)	REF 163TA9099 (for rubber and steel tracks)	REF 163TA9107 (front, with bracket assembly) (for rubber tracks)	REF 163TA9084 (rubber) (400 x 72,5 x 74)
REF 163TA9101 (for rubber and steel tracks) (outer guide)			REF 163TA9108 (front, with bracket assembly) (for steel tracks)	
S/N: 280001 - and up				
REF 163TA9102 (for rubber tracks) (inner guide)	REF 144TA9710 (assembly) (for rubber and steel tracks) (∅ flange = 108,00 mm) (∅ body = 93,00 mm)	REF 163TA9099 (for rubber and steel tracks)	REF 163TA9108 (front, with bracket assembly) (for steel tracks)	REF 163TA9084 (rubber) (400 x 72,5 x 74)
REF 163TA9101 (for rubber and steel tracks) (outer guide)			REF 163TA9107 (front, with bracket assembly) (for rubber tracks)	
VOLVO ECR88				
S/N: 010001 - 016546				
REF 144TA1866 (for rubber tracks) (inner guide) (∅ flange = 188,00 mm) (∅ body = 135,00 mm)	REF 144TA9708 (assembly) (for rubber and steel tracks) (∅ flange = 125,00 mm) (∅ body = 100,00 mm)	REF 144TA9705 (for rubber and steel tracks) (number of teeth = 21) (number of holes = 12)	REF 144TA9714 (front, with bracket assembly) (for rubber tracks) (depends on application)	REF 163TA9085 (rubber) (450 x 81w x 76)
REF 144TA9707 (for rubber and steel tracks) (outer guide) (∅ flange = 155,00 mm) (∅ body = 121,00 mm)			REF 144TA9709 (front, with bracket assembly) (for rubber and steel tracks) (depends on application)	
S/N: 014279 - and up				
REF 144TA9717 (for rubber tracks) (inner guide)	REF 144TA9708 (assembly) (for rubber and steel tracks) (∅ flange = 125,00 mm) (∅ body = 100,00 mm)	REF 144TA9705 (for rubber and steel tracks) (number of teeth = 21) (number of holes = 12)	REF 144TA9709 (front, with bracket assembly) (for rubber and steel tracks) (depends on application)	REF 163TA9085 (rubber) (450 x 81w x 76)
REF 144TA1866 (for rubber tracks) (inner guide) (∅ flange = 188,00 mm) (∅ body = 135,00 mm)				
REF 144TA9707 (for rubber and steel tracks) (outer guide) (∅ flange = 155,00 mm) (∅ body = 121,00 mm)				
S/N: 016547 - and up				
REF 144TA1866 (for rubber tracks) (inner guide) (∅ flange = 188,00 mm) (∅ body = 135,00 mm)	REF 144TA9708 (assembly) (for rubber and steel tracks) (∅ flange = 125,00 mm) (∅ body = 100,00 mm)	REF 144TA9705 (for rubber and steel tracks) (number of teeth = 21) (number of holes = 12)	REF 163TA9109 (front, with bracket assembly) (for rubber tracks) (depends on application)	REF 163TA9085 (rubber) (450 x 81w x 76)



used for VOLVO

used for VOLVO				
TRACK ROLLER	TOP ROLLER	SPROCKET	IDLER	TRACK
				
<p>REF 144TA9707 (for rubber and steel tracks) (outer guide) (Ø flange = 155,00 mm) (Ø body = 121,00 mm)</p>	<p>REF 144TA9708 (assembly) (for rubber and steel tracks) (Ø flange = 125,00 mm) (Ø body = 100,00 mm)</p>		<p>REF 163TA9110 (front, with bracket assembly) (for rubber and steel tracks) (depends on applicati</p> <p>REF 144TA9709 (front, with bracket assembly) (for rubber and steel tracks) (depends on application)</p>	
VOLVO ECR88D				
<i>S/N: 021001 - and up</i>				
<p>REF 163TA9103 (for rubber and steel tracks) (inner guide)</p> <p>REF 163TA9104 (for rubber and steel tracks) (outer guide)</p>	<p>REF 144TA9716 (assembly) (for rubber and steel tracks) (Ø flange = 125,00 mm) (Ø body = 100,00 mm)</p>	<p>REF 144TA9705 (for rubber and steel tracks) (number of teeth = 21) (number of holes = 12)</p>	<p>REF 163TA9109 (front, with bracket assembly) (for rubber tracks)</p> <p>REF 163TA9110 (front, with bracket assembly) (for steel tracks)</p>	<p>REF 163TA9086 (rubber) (450 x 81w x 76)</p>



USED FOR
YANMAR

TRACKS & UNDERCARRIAGE PARTS



used for YANMAR

used for YANMAR				
TRACK ROLLER	TOP ROLLER	SPROCKET	IDLER	TRACK
				
YANMAR B03				
REF 143TA8703 (for rubber tracks)		REF 144TA4322 (for rubber tracks)	REF 144TA4391 (front, with bracket assembly) (for rubber tracks)	REF 144TA4323 (rubber) (150 x 72 x 28)
YANMAR B05				
REF 143TA8703 (for rubber tracks)		REF 144TA4324 (for rubber tracks)	REF 144TA4392 (front, with bracket assembly) (for rubber tracks)	REF 143TA9992 (rubber) (150 x 72 x 34)
YANMAR B05RSCOPY				
		REF 144TA4324 (for rubber tracks)	REF 143TA9541 (front, with bracket assembly) (for rubber tracks)	REF 143TA9992 (rubber) (150 x 72 x 34)
YANMAR B05SCOPY				
		REF 144TA4324 (for rubber tracks)	REF 143TA9541 (front, with bracket assembly) (for rubber tracks)	REF 143TA9992 (rubber) (150 x 72 x 34)
YANMAR B08				
<i>S/P: AY - S/N: 00003629 - and up</i>				
REF 143TA8703 (for rubber tracks)		REF 143TA9253 (for rubber tracks)	REF 144TA4444 (front, with bracket assembly) (for rubber tracks)	REF 144TA4329 (rubber) (180 x 72 x 37)
<i>S/P: G - S/N: 00000501 - 00003628</i>				
REF 143TA8703 (for rubber tracks)		REF 143TA9253 (for rubber tracks)	REF 144TA4444 (front, with bracket assembly) (for rubber tracks)	REF 144TA4329 (rubber) (180 x 72 x 37)
YANMAR B08-3				
REF 144TA4254 (for rubber tracks) (∅ flange = 130,00 mm) (∅ body = 70,00 mm)		REF 143TA9253 (for rubber tracks)	REF 163TA9638 (front, with bracket assembly) (for rubber tracks) (with support) REF 163TA9639 (front, with bracket assembly) (for rubber tracks) (without support)	REF 143TA9993 (rubber) (180 x 72 x 37)
YANMAR B08RSCOPY				
REF 143TA8703 (for rubber tracks)		REF 144TA4345 (for rubber tracks)	REF 144TA4444 (front, with bracket assembly) (for rubber tracks)	REF 144TA4329 (rubber) (180 x 72 x 37)
YANMAR B08RV				
		REF 144TA4345 (for rubber tracks)		REF 144TA4329 (rubber) (180 x 72 x 37)
YANMAR B08RV-3				
REF 143TA8703 (for rubber tracks)			REF 144TA4400 (front, with bracket assembly) (for rubber tracks)	REF 144TA4329 (rubber) (180 x 72 x 37)
YANMAR B08RVSCOPY				
REF 143TA8703 (for rubber tracks)		REF 144TA4345 (for rubber tracks)	REF 144TA4444 (front, with bracket assembly) (for rubber tracks)	REF 144TA4329 (rubber) (180 x 72 x 37)
YANMAR B08SCOPY				
REF 143TA8703 (for rubber tracks)		REF 144TA4345 (for rubber tracks)	REF 144TA4444 (front, with bracket assembly) (for rubber tracks)	REF 144TA4329 (rubber) (180 x 72 x 37)



used for YANMAR				
TRACK ROLLER	TOP ROLLER	SPROCKET	IDLER	TRACK
				
YANMAR B10				
REF 163TA9589 (Ø flange = 129,50 mm) (Ø body = 68,00 mm)		REF 144TA4311	REF 144TA4387 (front, with bracket assembly)	REF 144TA4312 (rubber) (200 x 72 x 39)
YANMAR B12				
<i>S/P: AY-EP</i>				
REF 163TA9589 (for rubber tracks) (Ø flange = 129,50 mm) (Ø body = 68,00 mm)		REF 163TA9571 (for rubber tracks) (number of teeth = 14) (number of holes = 9) REF 163TA9570 (for steel tracks)	REF 143TA9545 (front, with bracket assembly) (for rubber tracks) (Ø = 282,00 mm)	REF 143TA9994 (rubber) (200 x 72 x 47) REF 144TA4314 (rubber) (230 x 72 x 43)
<i>S/P: H</i>				
REF 163TA9589 (for rubber tracks) (Ø flange = 129,50 mm) (Ø body = 68,00 mm)		REF 163TA9571 (for rubber tracks) (number of teeth = 14) (number of holes = 9)	REF 143TA9545 (front, with bracket assembly) (for rubber tracks) (Ø = 282,00 mm)	REF 143TA9994 (rubber) (200 x 72 x 47) REF 144TA4314 (rubber) (230 x 72 x 43)
YANMAR B12-2(B)				
REF 143TA8718 (for rubber tracks) (Ø flange = 129,50 mm) (Ø body = 68,00 mm)		REF 144TA4313 (for rubber tracks) (number of teeth = 14) (number of holes = 9)	REF 143TA9545 (front, with bracket assembly) (for rubber tracks) (Ø = 282,00 mm)	REF 144TA4314 (rubber) (230 x 72 x 43)
YANMAR B12-3				
REF 144TA4255 (for rubber tracks) (Ø flange = 130,00 mm) (Ø body = 70,00 mm)		REF 144TA4348 (for rubber tracks) (number of teeth = 14) (number of holes = 9)	REF 144TA4402 (front, with bracket assembly) (for rubber tracks)	REF 144TA4349 (rubber) (200 x 72 x 47) (with rail)
YANMAR B14				
<i>S/P: AY-EP</i>				
REF 163TA9589 (for rubber tracks) (Ø flange = 129,50 mm) (Ø body = 68,00 mm)		REF 163TA9571 (for rubber tracks) (number of teeth = 14) (number of holes = 9)	REF 143TA9545 (front, with bracket assembly) (for rubber tracks) (Ø = 282,00 mm)	REF 144TA4314 (rubber) (230 x 72 x 43) REF 143TA9994 (rubber) (200 x 72 x 47)
<i>S/P: H</i>				
REF 163TA9589 (for rubber tracks) (Ø flange = 129,50 mm) (Ø body = 68,00 mm)		REF 163TA9571 (for rubber tracks) (number of teeth = 14) (number of holes = 9)	REF 143TA9545 (front, with bracket assembly) (for rubber tracks) (Ø = 282,00 mm)	REF 143TA9994 (rubber) (200 x 72 x 47) REF 144TA4314 (rubber) (230 x 72 x 43)
YANMAR B15				
REF 163TA9589 (for rubber tracks) (Ø flange = 129,50 mm) (Ø body = 68,00 mm)		REF 163TA9571 (for rubber tracks) (number of teeth = 14) (number of holes = 9)	REF 143TA9545 (front, with bracket assembly) (for rubber tracks) (Ø = 282,00 mm)	REF 143TA9994 (rubber) (200 x 72 x 47)
YANMAR B15-3				
REF 144TA4256 (for rubber tracks) (Ø flange = 130,00 mm) (Ø body = 64,00 mm)		REF 144TA4348 (for rubber tracks) (number of teeth = 14) (number of holes = 9)	REF 144TA4446 (front, with bracket assembly) (for rubber tracks) (Ø = 295,00 mm)	REF 163TA9562 (rubber) (200 x 72 x 47)



used for YANMAR				
TRACK ROLLER	TOP ROLLER	SPROCKET	IDLER	TRACK
				
		REF 144TA4445 (for rubber tracks) (number of teeth = 14) (number of holes = 9)		
YANMAR B15-3EX				
REF 144TA4256 (for rubber tracks) (∅ flange = 130,00 mm) (∅ body = 64,00 mm)		REF 143TA9256 (for rubber tracks) (number of teeth = 14) (number of holes = 9)	REF 144TA4354 (front, with bracket assembly) (for rubber tracks) REF 144TA4446 (front, with bracket assembly) (for rubber tracks) (∅ = 295,00 mm)	REF 144TA4303 (rubber) (230 x 72 x 47) (with rail) REF 163TA9562 (rubber) (200 x 72 x 47)
YANMAR B15EX				
REF 163TA9589 (for rubber tracks) (∅ flange = 129,50 mm) (∅ body = 68,00 mm)		REF 163TA9571 (for rubber tracks) (number of teeth = 14) (number of holes = 9)	REF 143TA9545 (front, with bracket assembly) (for rubber tracks) (∅ = 282,00 mm)	REF 164TA3077 (rubber) (230 x 72 x 47) REF 143TA9994 (rubber) (200 x 72 x 47)
YANMAR B17				
<i>S/P: AY-EP</i>				
REF 163TA9589 (∅ flange = 129,50 mm) (∅ body = 68,00 mm)		REF 163TA9571 (for rubber tracks) (number of teeth = 14) (number of holes = 9) REF 163TA9570 (for steel tracks)	REF 143TA9545 (front, with bracket assembly) (∅ = 282,00 mm)	REF 144TA4314 (rubber) (230 x 72 x 43) REF 143TA9994 (rubber) (200 x 72 x 47)
<i>S/P: H</i>				
REF 163TA9589 (∅ flange = 129,50 mm) (∅ body = 68,00 mm)		REF 163TA9571 (for rubber tracks) (number of teeth = 14) (number of holes = 9) REF 163TA9570 (for steel tracks)	REF 143TA9545 (front, with bracket assembly) (∅ = 282,00 mm)	REF 143TA9994 (rubber) (200 x 72 x 47) REF 144TA4314 (rubber) (230 x 72 x 43)
YANMAR B17-2				
REF 163TA9589 (for rubber tracks) (∅ flange = 129,50 mm) (∅ body = 68,00 mm)		REF 163TA9571 (for rubber tracks) (number of teeth = 14) (number of holes = 9)	REF 163TA9637 (front, with bracket assembly) (for rubber tracks)	REF 144TA4334 (rubber) (230 x 72 x 43) REF 143TA9994 (steel) (200 x 72 x 47)
YANMAR B17-3				
REF 144TA4256 (for rubber tracks) (∅ flange = 130,00 mm) (∅ body = 64,00 mm)		REF 144TA4348 (for rubber tracks) (number of teeth = 14) (number of holes = 9) REF 144TA4445 (for rubber tracks) (number of teeth = 14) (number of holes = 9)	REF 144TA4446 (front, with bracket assembly) (for rubber tracks) (∅ = 295,00 mm)	REF 163TA9562 (rubber) (200 x 72 x 47)



used for YANMAR				
TRACK ROLLER	TOP ROLLER	SPROCKET	IDLER	TRACK
				
YANMAR B18				
REF 144TA4256 (for rubber tracks) (Ø flange = 130,00 mm) (Ø body = 64,00 mm)		REF 143TA9256 (for rubber tracks) (number of teeth = 14) (number of holes = 9)	REF 144TA4446 (front, with bracket assembly) (for rubber tracks) (Ø = 295,00 mm)	REF 144TA4355 (rubber) (230 x 72 x 47) (with rail)
YANMAR B18EX				
REF 144TA4256 (for rubber tracks) (Ø flange = 130,00 mm) (Ø body = 64,00 mm)		REF 143TA9256 (for rubber tracks) (number of teeth = 14) (number of holes = 9)	REF 144TA4446 (front, with bracket assembly) (for rubber tracks) (Ø = 295,00 mm)	REF 144TA1010 (rubber) (230 x 72 x 47)
YANMAR B19				
REF 163TA9590 (for rubber tracks) (Ø flange = 110,00 mm) (Ø body = 70,00 mm)		REF 143TA9161 (for rubber tracks) (number of teeth = 23) (number of holes = 9)	REF 144TA4397 (front, with bracket assembly) (for rubber tracks)	REF 143TA9996 (rubber) (260 x 96 x 38)
YANMAR B22				
REF 163TA9591 (Ø flange = 140,00 mm) (Ø body = 78,00 mm)		REF 163TA9572 (number of teeth = 21) (number of holes = 11)	REF 163TA9641 (front, with bracket assembly) (for rubber tracks) (Ø = 330,00 mm) REF 163TA9642 (front, with bracket assembly) (for steel tracks)	REF 143TA9997 (rubber) (280 x 106 x 35)
YANMAR B22-1				
<i>S/N: 00001099 - and up</i>				
REF 163TA9591 (Ø flange = 140,00 mm) (Ø body = 78,00 mm)		REF 163TA9572 (number of teeth = 21) (number of holes = 11)	REF 163TA9642 (front, with bracket assembly) (for steel tracks) REF 163TA9641 (front, with bracket assembly) (for rubber tracks) (Ø = 330,00 mm)	REF 143TA9997 (rubber) (280 x 106 x 35)
YANMAR B22-2				
REF 163TA9591 (Ø flange = 140,00 mm) (Ø body = 78,00 mm)		REF 163TA9572 (number of teeth = 21) (number of holes = 11)	REF 163TA9642 (front, with bracket assembly) (for steel tracks) REF 163TA9641 (front, with bracket assembly) (for rubber tracks) (Ø = 330,00 mm)	REF 143TA9997 (rubber) (280 x 106 x 35)
YANMAR B22-2A				
REF 143TA8733 (Ø flange = 140,00 mm) (Ø body = 78,00 mm)		REF 163TA9572 (number of teeth = 21) (number of holes = 11)	REF 163TA9641 (front, with bracket assembly) (for rubber tracks) (Ø = 330,00 mm) REF 163TA9642 (front, with bracket assembly) (for steel tracks)	REF 143TA9997 (rubber) (280 x 106 x 35)
YANMAR B25				
REF 143TA8733 (Ø flange = 140,00 mm) (Ø body = 78,00 mm)	REF 163TA9633 (guide) (plate type)	REF 143TA9173 (number of teeth = 21) (number of holes = 11)	REF 144TA4388 (front, with bracket assembly) (for steel tracks) (Ø = 330,00 mm)	REF 143TA9997 (rubber) (280 x 106 x 35)



used for YANMAR				
TRACK ROLLER	TOP ROLLER	SPROCKET	IDLER	TRACK
				
	REF 163TA9634 (guide) (for steel tracks) (plate type)		REF 144TA4389 (front, with bracket assembly) (for rubber tracks) (Ø = 330,00 mm)	
YANMAR B25-1				
REF 143TA8733 (Ø flange = 140,00 mm) (Ø body = 78,00 mm)	REF 163TA9633 (guide) (plate type) REF 163TA9634 (guide) (for steel tracks) (plate type)	REF 143TA9173 (number of teeth = 21) (number of holes = 11)	REF 144TA4388 (front, with bracket assembly) (for steel tracks) (Ø = 330,00 mm) REF 144TA4389 (front, with bracket assembly) (for rubber tracks) (Ø = 330,00 mm)	REF 143TA9997 (rubber) (280 x 106 x 35)
YANMAR B25V				
REF 163TA9591 (Ø flange = 140,00 mm) (Ø body = 78,00 mm)	REF 143TA8951 (assembly) (Ø body = 80,00 mm)	REF 163TA9572 (number of teeth = 21) (number of holes = 11)	REF 144TA4398 (front, with bracket assembly)	REF 163TA9563 (rubber) (300 x 55,5 x 76) (offset)
YANMAR B25V-1				
<i>S/P: CE2F</i>				
REF 163TA9591 (Ø flange = 140,00 mm) (Ø body = 78,00 mm)	REF 144TA1780 (assembly) (Ø body = 80,00 mm) REF 144TA4351 (assembly) (Ø body = 80,00 mm)	REF 163TA9572 (number of teeth = 21) (number of holes = 11)	REF 144TA4404 (front, with bracket assembly) (for rubber tracks) (Ø = 330,00 mm) REF 163TA9645 (front, with bracket assembly) (for steel tracks)	REF 144TA1015 (rubber) (260 x 55,5 x 78) (offset)
YANMAR B25VCR				
REF 163TA9591 (for asymmetrical rubber tracks) (Ø flange = 140,00 mm) (Ø body = 78,00 mm)	REF 143TA8951 (assembly) (for asymmetrical rubber tracks) (Ø body = 80,00 mm)	REF 163TA9572 (for asymmetrical rubber tracks) (number of teeth = 21) (number of holes = 11)	REF 144TA4398 (front, with bracket assembly) (for asymmetrical rubber tracks) (Ø = 332,00 mm)	REF 163TA9563 (rubber) (300 x 55,5 x 76) (offset)
YANMAR B27				
REF 163TA9591 (Ø flange = 140,00 mm) (Ø body = 78,00 mm)	REF 163TA9591 (assembly) (Ø flange = 140,00 mm) (Ø body = 78,00 mm)	REF 163TA9572 (number of teeth = 21) (number of holes = 11)	REF 163TA9642 (front, with bracket assembly) (for steel tracks) REF 163TA9641 (front, with bracket assembly) (for rubber tracks) (Ø = 330,00 mm)	REF 144TA4316 (rubber) (320 x 106 x 39)
YANMAR B27-2				
REF 163TA9591 (Ø flange = 140,00 mm) (Ø body = 78,00 mm)	REF 163TA9620 (assembly) (Ø body = 80,00 mm)	REF 163TA9572 (number of teeth = 21) (number of holes = 11)	REF 163TA9641 (front, with bracket assembly) (for rubber tracks) (Ø = 330,00 mm) REF 163TA9642 (front, with bracket assembly) (for steel tracks)	REF 144TA4316 (rubber) (320 x 106 x 39)
YANMAR B27-2A				
REF 163TA9591 (Ø flange = 140,00 mm) (Ø body = 78,00 mm)	REF 144TA4301 (assembly) (Ø body = 80,00 mm)	REF 163TA9572 (number of teeth = 21) (number of holes = 11)	REF 163TA9643 (front, with bracket assembly) (for steel tracks)	REF 144TA4316 (rubber) (320 x 106 x 39)



used for YANMAR				
TRACK ROLLER	TOP ROLLER	SPROCKET	IDLER	TRACK
				
			REF 163TA9641 (front, with bracket assembly) (for rubber tracks) (Ø = 330,00 mm)	
YANMAR B3				
<i>S/N: up to - 00000594</i>				
REF 163TA9592 (for steel tracks)	REF 163TA9618 (assembly) (for steel tracks) (Ø body = 80,00 mm)	REF 143TA9173 (for steel tracks) (number of teeth = 21) (number of holes = 11)	REF 163TA9643 (front, with bracket assembly) (for steel tracks)	REF 144TA4316 (rubber) (320 x 106 x 39)
REF 163TA9593 (for rubber tracks)	REF 144TA4386 (assembly) (for rubber tracks)	REF 144TA4456 (for rubber tracks) (number of teeth = 12) (number of holes = 9)	REF 163TA9644 (front, with bracket assembly) (for rubber tracks)	
<i>S/N: 00000595 - and up</i>				
REF 143TA8733 (Ø flange = 140,00 mm) (Ø body = 78,00 mm)	REF 163TA9619 (assembly)	REF 143TA9173 (number of teeth = 21) (number of holes = 11)	REF 163TA9643 (front, with bracket assembly) (for steel tracks) REF 163TA9652 (front, with bracket assembly) (for rubber tracks)	REF 144TA4316 (rubber) (320 x 106 x 39)
YANMAR B30				
REF 144TA4258 (Ø flange = 140,00 mm) (Ø body = 78,00 mm)	REF 144TA4301 (assembly) (Ø body = 80,00 mm)	REF 163TA9583 (number of teeth = 21) (number of holes = 11)	REF 144TA4398 (front, with bracket assembly) (for rubber tracks) (Ø = 332,00 mm) REF 163TA9646 (front, with bracket assembly) (for steel tracks) (Ø = 332,00 mm)	REF 144TA4340 (rubber) (300 x 55,5 x 82)
YANMAR B30V				
REF 163TA9591 (Ø flange = 140,00 mm) (Ø body = 78,00 mm)	REF 143TA8951 (assembly) (Ø body = 80,00 mm)	REF 163TA9572 (number of teeth = 21) (number of holes = 11)	REF 163TA9646 (front, with bracket assembly) (for steel tracks) (Ø = 332,00 mm) REF 144TA4398 (front, with bracket assembly) (for rubber tracks) (Ø = 332,00 mm)	REF 143TA9867 (rubber) (300 x 55,5 x 82)
YANMAR B3-1				
<i>S/N: up to - 00000594</i>				
REF 163TA9592 (for steel tracks)	REF 163TA9618 (assembly) (for steel tracks) (Ø body = 80,00 mm)	REF 143TA9173 (for steel tracks) (number of teeth = 21) (number of holes = 11)	REF 163TA9643 (front, with bracket assembly) (for steel tracks)	REF 144TA4316 (rubber) (320 x 106 x 39)
REF 163TA9593 (for rubber tracks)	REF 144TA4386 (assembly) (for rubber tracks)	REF 144TA4456 (for rubber tracks) (number of teeth = 12) (number of holes = 9)	REF 163TA9644 (front, with bracket assembly) (for rubber tracks)	
<i>S/N: 00000595 - and up</i>				
REF 143TA8733 (Ø flange = 140,00 mm) (Ø body = 78,00 mm)	REF 163TA9619 (assembly)	REF 143TA9173 (number of teeth = 21) (number of holes = 11)	REF 163TA9643 (front, with bracket assembly) (for steel tracks)	REF 144TA4316 (rubber) (320 x 106 x 39)







used for YANMAR				
TRACK ROLLER	TOP ROLLER	SPROCKET	IDLER	TRACK
				
			REF 163TA9652 (front, with bracket assembly) (for rubber tracks)	
YANMAR B3-2				
<i>S/N: up to - 00000594</i>				
REF 163TA9592 (for steel tracks)	REF 163TA9618 (assembly) (for steel tracks) (Ø body = 80,00 mm)	REF 143TA9173 (for steel tracks) (number of teeth = 21) (number of holes = 11)	REF 163TA9643 (front, with bracket assembly) (for steel tracks)	REF 144TA4316 (rubber) (320 x 106 x 39)
REF 163TA9593 (for rubber tracks)	REF 144TA4386 (assembly) (for rubber tracks)	REF 144TA4456 (for rubber tracks) (number of teeth = 12) (number of holes = 9)	REF 163TA9644 (front, with bracket assembly) (for rubber tracks)	
<i>S/N: 00000595 - and up</i>				
REF 143TA8733 (Ø flange = 140,00 mm) (Ø body = 78,00 mm)	REF 163TA9619 (assembly)	REF 143TA9173 (number of teeth = 21) (number of holes = 11)	REF 163TA9643 (front, with bracket assembly) (for steel tracks) REF 163TA9652 (front, with bracket assembly) (for rubber tracks)	REF 144TA4316 (rubber) (320 x 106 x 39)
YANMAR B37				
REF 163TA9594	REF 144TA4390 (assembly)	REF 163TA9574	REF 163TA9647 (front, with bracket assembly) (for rubber tracks) REF 163TA9648 (front, with bracket assembly) (for steel tracks)	REF 144TA1001 (rubber) (370 x 107 x 41)
YANMAR B37-2				
<i>S/N: up to - 00021723</i>				
REF 163TA9594	REF 163TA9620 (assembly) (Ø body = 80,00 mm)	REF 163TA9574	REF 163TA9650 (front, with bracket assembly) (for rubber tracks) (w) REF 163TA9649 (front, with bracket assembly) (for steel tracks)	REF 144TA1001 (rubber) (370 x 107 x 41)
<i>S/N: 00021724 - and up</i>				
REF 163TA9594	REF 163TA9620 (assembly) (Ø body = 80,00 mm)	REF 163TA9574	REF 163TA9647 (front, with bracket assembly) (for rubber tracks) (n) REF 163TA9649 (front, with bracket assembly) (for steel tracks)	REF 144TA1001 (rubber) (370 x 107 x 41)
YANMAR B37-2A				
REF 163TA9594	REF 144TA4301 (assembly) (Ø body = 80,00 mm)	REF 163TA9574	REF 163TA9651 (front, with bracket assembly) (for steel tracks) REF 144TA4321 (front, with bracket assembly) (for rubber tracks)	REF 144TA1001 (rubber) (370 x 107 x 41)
YANMAR B37V				
REF 163TA9591 (Ø flange = 140,00 mm) (Ø body = 78,00 mm)	REF 143TA8951 (assembly) (Ø body = 80,00 mm)	REF 163TA9572 (number of teeth = 21) (number of holes = 11)	REF 144TA4398 (front, with bracket assembly) (for rubber tracks) (Ø = 332,00 mm)	REF 163TA9564 (rubber) (300 x 55,5 x 82)



used for YANMAR				
TRACK ROLLER	TOP ROLLER	SPROCKET	IDLER	TRACK
				
			REF 163TA9646 (front, with bracket assembly) (for steel tracks) (Ø = 332,00 mm)	
YANMAR B3V				
REF 143TA8733 (for rubber tracks) (Ø flange = 140,00 mm) (Ø body = 78,00 mm)	REF 144TA4301 (assembly) (for rubber tracks) (Ø body = 80,00 mm)	REF 163TA9583 (for rubber tracks) (number of teeth = 21) (number of holes = 11)	REF 144TA4398 (front, with bracket assembly) (for rubber tracks) (Ø = 332,00 mm)	REF 144TA1001 (rubber) (370 x 107 x 41)
YANMAR B5				
REF 143TA8757 (Ø flange = 159,50 mm) (Ø body = 111,00 mm)	REF 143TA8958 (assembly) (Ø body = 80,00 mm)	REF 163TA9575 (number of teeth = 19) (number of holes = 9)	REF 143TA9480 (front, with bracket assembly) (for rubber tracks) REF 163TA9653 (front, with bracket assembly) (for steel tracks)	REF 144TA4320 (rubber) (400 x 144 x 36)
YANMAR B50				
REF 163TA9595 (Ø flange = 159,50 mm) (Ø body = 111,00 mm)	REF 143TA8958 (assembly) (Ø body = 80,00 mm)	REF 163TA9575 (number of teeth = 19) (number of holes = 9)	REF 143TA9471 (front, with bracket assembly) (for steel tracks) (Ø = 375,00 mm) REF 143TA9480 (front, with bracket assembly) (for rubber tracks)	REF 144TA4319 (rubber) (400 x 72,5 x 72) REF 144TA4320 (rubber) (400 x 144 x 36)
YANMAR B50-1				
REF 163TA9595 (Ø flange = 159,50 mm) (Ø body = 111,00 mm)	REF 143TA8958 (assembly) (Ø body = 80,00 mm)	REF 163TA9575 (number of teeth = 19) (number of holes = 9)	REF 143TA9480 (front, with bracket assembly) (for rubber tracks) REF 143TA9471 (front, with bracket assembly) (for steel tracks) (Ø = 375,00 mm)	REF 144TA4320 (rubber) (400 x 144 x 36) REF 144TA4319 (rubber) (400 x 72,5 x 72)
YANMAR B50-2				
REF 163TA9595 (Ø flange = 159,50 mm) (Ø body = 111,00 mm)	REF 143TA8958 (assembly) (Ø body = 80,00 mm)	REF 163TA9575 (number of teeth = 19) (number of holes = 9)	REF 143TA9480 (front, with bracket assembly) (for rubber tracks) REF 143TA9471 (front, with bracket assembly) (for steel tracks) (Ø = 375,00 mm)	REF 144TA4320 (rubber) (400 x 144 x 36) REF 144TA4319 (rubber) (400 x 72,5 x 72)
YANMAR B50-2A				
REF 163TA9595 (Ø flange = 159,50 mm) (Ø body = 111,00 mm)	REF 143TA8958 (assembly) (Ø body = 80,00 mm)	REF 163TA9575 (number of teeth = 19) (number of holes = 9)	REF 143TA9480 (front, with bracket assembly) (for rubber tracks) REF 143TA9471 (front, with bracket assembly) (for steel tracks) (Ø = 375,00 mm)	REF 144TA4320 (rubber) (400 x 144 x 36) REF 144TA4319 (rubber) (400 x 72,5 x 72)
YANMAR B50-2B				
<i>S/N: up to - 72437067</i>				
REF 163TA9595 (Ø flange = 159,50 mm) (Ø body = 111,00 mm)	REF 163TA9622 (assembly) (Ø flange = 130,00 mm) (Ø body = 87,00 mm)	REF 163TA9575 (number of teeth = 19) (number of holes = 9)	REF 163TA9656 (front, with bracket assembly) (Ø = 381,00 mm)	REF 163TA9565 (rubber) (400 x 75,5 x 74)



used for YANMAR				
TRACK ROLLER	TOP ROLLER	SPROCKET	IDLER	TRACK
				
	REF 144TA4356 (assembly) (Ø body = 80,00 mm)		REF 143TA9471 (front, with bracket assembly) (Ø = 375,00 mm) REF 163TA9657 (front, with bracket assembly) (Ø = 398,00 mm) (height = 420,00 mm)	
<i>S/N: 72437068 - and up</i>				
REF 163TA9596	REF 163TA9622 (assembly) (Ø flange = 130,00 mm) (Ø body = 87,00 mm) REF 144TA4356 (assembly) (Ø body = 80,00 mm)	REF 163TA9575 (number of teeth = 19) (number of holes = 9)	REF 163TA9656 (front, with bracket assembly) (Ø = 381,00 mm) REF 143TA9471 (front, with bracket assembly) (Ø = 375,00 mm) REF 163TA9657 (front, with bracket assembly) (Ø = 398,00 mm) (height = 420,00 mm)	REF 163TA9565 (rubber) (400 x 75,5 x 74)
<i>S/N: 72460260 - and up</i>				
	REF 144TA4356 (assembly) (Ø body = 80,00 mm) REF 163TA9622 (assembly) (Ø flange = 130,00 mm) (Ø body = 87,00 mm)	REF 163TA9575 (number of teeth = 19) (number of holes = 9)	REF 163TA9656 (front, with bracket assembly) (Ø = 381,00 mm) REF 143TA9471 (front, with bracket assembly) (Ø = 375,00 mm) REF 163TA9657 (front, with bracket assembly) (Ø = 398,00 mm) (height = 420,00 mm)	REF 163TA9565 (rubber) (400 x 75,5 x 74)
<i>S/N: 72467010 - and up</i>				
	REF 163TA9622 (assembly) (Ø flange = 130,00 mm) (Ø body = 87,00 mm) REF 144TA4356 (assembly) (Ø body = 80,00 mm)	REF 163TA9575 (number of teeth = 19) (number of holes = 9)	REF 163TA9656 (front, with bracket assembly) (Ø = 381,00 mm) REF 143TA9471 (front, with bracket assembly) (Ø = 375,00 mm) REF 163TA9657 (front, with bracket assembly) (Ø = 398,00 mm) (height = 420,00 mm)	REF 144TA4342 (rubber) (400 x 75,5 x 74) (offset) REF 163TA9565 (rubber) (400 x 75,5 x 74)
YANMAR B50V				
<i>S/N: 00060560 - and up</i>				
REF 143TA8757 (for rubber tracks) (Ø flange = 159,50 mm) (Ø body = 111,00 mm) REF 144TA4260 (for asymmetrical rubber tracks) (Ø flange = 159,50 mm) (Ø body = 111,00 mm)	REF 144TA4338 (assembly) (for rubber tracks) (Ø body = 80,00 mm) REF 143TA8958 (assembly) (for asymmetrical rubber tracks) (Ø body = 80,00 mm)	REF 143TA9183 (for rubber tracks) (number of teeth = 19) (number of holes = 9) REF 144TA4306 (for asymmetrical rubber tracks) (number of teeth = 19) (number of holes = 9)	REF 144TA4309 (front, with bracket assembly) (for rubber tracks) REF 143TA9471 (front, with bracket assembly) (for asymmetrical rubber tracks) (Ø = 375,00 mm)	REF 144TA4342 (rubber) (400 x 75,5 x 74) (offset) REF 144TA1003 (rubber) (400 x 75,5 x 74) (offset)



used for YANMAR				
TRACK ROLLER	TOP ROLLER	SPROCKET	IDLER	TRACK
				
YANMAR B5-1				
REF 143TA8757 (∅ flange = 159,50 mm) (∅ body = 111,00 mm)	REF 143TA8958 (assembly) (∅ body = 80,00 mm)	REF 163TA9575 (number of teeth = 19) (number of holes = 9)	REF 143TA9480 (front, with bracket assembly) (for rubber tracks) REF 163TA9653 (front, with bracket assembly) (for steel tracks)	REF 144TA4320 (rubber) (400 x 144 x 36)
YANMAR B5-2				
REF 143TA8757 (∅ flange = 159,50 mm) (∅ body = 111,00 mm)	REF 163TA9621 (assembly)	REF 163TA9575 (number of teeth = 19) (number of holes = 9)	REF 163TA9654 (front, with bracket assembly) (for rubber tracks) REF 163TA9655 (front, with bracket assembly) (for steel tracks)	REF 144TA4320 (rubber) (400 x 144 x 36)
YANMAR B7				
REF 144TA4263 (outer guide) REF 163TA9597 (double guide)	REF 144TA4395 (assembly)	REF 143TA9260	REF 163TA9658 (front, with bracket assembly) (for rubber tracks) REF 144TA4394 (front, with bracket assembly) (for steel tracks)	REF 144TA4330 (rubber) (450 x 71 x 80)
YANMAR B7-3				
REF 163TA9599 (∅ flange = 176,00 mm) (∅ body = 120,00 mm) (green 98) REF 163TA9598	REF 144TA4356 (assembly) (∅ body = 80,00 mm)	REF 163TA9576 (number of teeth = 19) (number of holes = 12)	REF 144TA4407 (front, with bracket assembly) (∅ = 418,00 mm) REF 164TA2150 (front, with bracket assembly) (∅ = 429,00 mm) REF 164TA2151 (front, with bracket assembly) (∅ = 410,00 mm)	REF 144TA4350 (rubber) (450 x 83,5 x 74) (offset)
YANMAR B7-5				
REF 144TA4261 (∅ flange = 176,00 mm) (∅ body = 120,00 mm)	REF 144TA4356 (assembly) (∅ body = 80,00 mm)	REF 163TA9576 (number of teeth = 19) (number of holes = 12)	REF 144TA4407 (front, with bracket assembly) (∅ = 418,00 mm)	REF 144TA4350 (rubber) (450 x 83,5 x 74) (offset)
YANMAR B7-5A				
<i>S/N: up to - 00057929</i>				
REF 144TA4261 (∅ flange = 176,00 mm) (∅ body = 120,00 mm)	REF 144TA4356 (assembly) (∅ body = 80,00 mm)	REF 163TA9577 (number of teeth = 19) (number of holes = 12)	REF 163TA9659 (front, with bracket assembly) (∅ = 418,00 mm)	REF 144TA4350 (rubber) (450 x 83,5 x 74) (offset)
<i>S/N: 00057930 - 00058702</i>				
REF 144TA4262	REF 144TA4356 (assembly) (∅ body = 80,00 mm)	REF 163TA9577 (number of teeth = 19) (number of holes = 12)	REF 163TA9659 (front, with bracket assembly) (∅ = 418,00 mm)	REF 144TA4350 (rubber) (450 x 83,5 x 74) (offset)
<i>For all other serial ranges applicable</i>				
	REF 144TA4356 (assembly) (∅ body = 80,00 mm)	REF 163TA9577 (number of teeth = 19) (number of holes = 12)	REF 163TA9659 (front, with bracket assembly) (∅ = 418,00 mm)	REF 144TA4350 (rubber) (450 x 83,5 x 74) (offset)
YANMAR C10R				
REF 144TA4264 (∅ flange = 150,00 mm) (∅ body = 65,30 mm)	REF 144TA4366 (assembly) (∅ flange = 122,00 mm) (∅ body = 57,50 mm)	REF 144TA4365	REF 144TA4412 (front, with bracket assembly) (∅ = 160,00 mm)	REF 144TA4368 (rubber) (230 x 72 x 50)

TRACKS & UNDERCARRIAGE PARTS



used for YANMAR

used for YANMAR				
TRACK ROLLER	TOP ROLLER	SPROCKET	IDLER	TRACK
				
YANMAR C10R-1				
REF 163TA9600 (Ø flange = 150,00 mm) (Ø body = 65,00 mm)	REF 163TA9600 (assembly) (Ø flange = 150,00 mm) (Ø body = 65,00 mm)	REF 144TA4376 (number of teeth = 9)	REF 163TA9660 (front, with bracket assembly)	REF 144TA4368 (rubber) (230 x 72 x 50)
YANMAR C120R				
REF 143TA8841 (for rubber tracks)	REF 143TA9005 (assembly) (for rubber tracks)		REF 144TA4448 (front, with bracket assembly) (for rubber tracks)	REF 144TA4450 (rubber) (800 x 150 x 70)
YANMAR C12R				
REF 163TA9601 (Ø flange = 150,00 mm) (Ø body = 65,00 mm)	REF 163TA9601 (assembly) (Ø flange = 150,00 mm) (Ø body = 65,00 mm)	REF 163TA9578 (number of teeth = 9)	REF 163TA9661 (front, with bracket assembly)	REF 144TA4381 (rubber) (230 x 72 x 50)
YANMAR C12R-A				
REF 163TA9601 (Ø flange = 150,00 mm) (Ø body = 65,00 mm)	REF 163TA9601 (assembly) (Ø flange = 150,00 mm) (Ø body = 65,00 mm)	REF 163TA9578 (number of teeth = 9)	REF 163TA9661 (front, with bracket assembly)	REF 144TA4381 (rubber) (230 x 72 x 50)
YANMAR C12R-B				
REF 163TA9601 (Ø flange = 150,00 mm) (Ø body = 65,00 mm)	REF 163TA9601 (assembly) (Ø flange = 150,00 mm) (Ø body = 65,00 mm)	REF 163TA9578 (number of teeth = 9)	REF 163TA9661 (front, with bracket assembly)	REF 144TA4381 (rubber) (230 x 72 x 50)
YANMAR C20R				
REF 144TA4268 (for rubber tracks) (inner guide)	REF 144TA4411 (assembly) (for rubber tracks) (Ø flange = 159,50 mm) (Ø body = 111,00 mm)	REF 144TA4362 (for rubber tracks) (number of teeth = 13) (number of holes = 8)	REF 144TA4410 (front, with bracket assembly) (for rubber tracks)	REF 144TA4371 (rubber) (320 x 90 x 52)
REF 144TA4269 (for rubber tracks) (outer guide)				
YANMAR C25R				
		REF 144TA4362 (for rubber tracks) (number of teeth = 13) (number of holes = 8)		REF 144TA4379 (rubber) (320 x 90 x 56)
YANMAR C30E-2A				
<i>S/N: 00020939 - and up</i>				
REF 144TA4275 (for rubber tracks) (outer guide) (Ø flange = 188,00 mm) (Ø body = 84,00 mm)	REF 144TA4418 (assembly) (for rubber tracks)	REF 144TA4364 (for rubber tracks) (number of teeth = 13) (number of holes = 8)	REF 144TA4415 (front, with bracket assembly) (for rubber tracks)	REF 144TA4379 (rubber) (320 x 90 x 56)
REF 144TA4274 (for rubber tracks) (inner guide)				
YANMAR C30R				
REF 144TA4269 (for rubber tracks) (outer guide)	REF 144TA4411 (assembly) (for rubber tracks) (Ø flange = 159,50 mm) (Ø body = 111,00 mm)	REF 144TA4362 (for rubber tracks) (number of teeth = 13) (number of holes = 8)	REF 144TA4410 (front, with bracket assembly) (for rubber tracks)	REF 144TA4373 (rubber) (320 x 90 x 56)
REF 144TA4268 (for rubber tracks) (inner guide)				



used for YANMAR				
TRACK ROLLER	TOP ROLLER	SPROCKET	IDLER	TRACK
				
YANMAR C30R-1				
<i>S/N: 00010502 - and up</i>				
REF 144TA4271 (for rubber tracks) (outer guide) (∅ flange = 188,00 mm) (∅ body = 84,00 mm)	REF 144TA4416 (assembly) (for rubber tracks) (∅ body = 80,00 mm)	REF 144TA4362 (for rubber tracks) (number of teeth = 13) (number of holes = 8)	REF 144TA4413 (front, with bracket assembly) (for rubber tracks)	
REF 144TA4270 (for rubber tracks) (inner guide)				
YANMAR C30R-2				
<i>S/N: 00020501 - 00020938</i>				
REF 144TA4273 (for rubber tracks) (inner guide) (∅ flange = 188,00 mm) (∅ body = 84,00 mm)	REF 144TA4417 (assembly) (for rubber tracks)	REF 144TA4363 (for rubber tracks) (number of teeth = 13) (number of holes = 8)	REF 144TA4414 (front, with bracket assembly) (for rubber tracks)	REF 144TA4379 (rubber) (320 x 90 x 56)
REF 144TA4272 (for rubber tracks) (outer guide)				
YANMAR C30RY				
		REF 144TA4362 (for rubber tracks) (number of teeth = 13) (number of holes = 8)		REF 144TA4379 (rubber) (320 x 90 x 56)
YANMAR C50R				
REF 164TA1511 (for rubber tracks) (outer guide)	REF 144TA4451 (assembly) (for rubber tracks)	REF 144TA4424 (for rubber tracks)	REF 144TA4423 (front, with bracket assembly) (for rubber tracks)	REF 144TA4369 (rubber) (500 x 90 x 82)
REF 144TA4276 (for rubber tracks) (inner guide)				
YANMAR C50R-1				
REF 144TA4278 (for rubber tracks) (outer guide) (∅ flange = 240,00 mm) (∅ body = 112,00 mm)	REF 144TA4428 (assembly) (for rubber tracks) (∅ flange = 174,00 mm)	REF 144TA4424 (for rubber tracks)	REF 144TA4452 (front, with bracket assembly) (for rubber tracks)	REF 144TA4369 (rubber) (500 x 90 x 82)
REF 144TA4292 (for rubber tracks) (inner guide) (∅ flange = 270,00 mm)				
YANMAR C50R-2				
REF 144TA4278 (for rubber tracks) (outer guide) (∅ flange = 240,00 mm) (∅ body = 112,00 mm)	REF 144TA4428 (assembly) (for rubber tracks) (∅ flange = 174,00 mm)	REF 144TA4424 (for rubber tracks)	REF 144TA4452 (front, with bracket assembly) (for rubber tracks)	REF 144TA4369 (rubber) (500 x 90 x 82)
REF 144TA4292 (for rubber tracks) (inner guide) (∅ flange = 270,00 mm)				
YANMAR C50R-3				
<i>S/N: 00040503 - 00040570</i>				
REF 144TA4279 (for rubber tracks)	REF 144TA4425 (assembly) (for rubber tracks) (∅ flange = 260,00 mm)	REF 144TA4429 (for rubber tracks) (number of teeth = 17) (number of holes = 15)	REF 144TA4430 (front, with bracket assembly) (for rubber tracks)	REF 144TA4433 (rubber) (450 x 110 x 74)
REF 144TA4294 (for rubber tracks)	REF 144TA4454 (assembly) (for rubber tracks) (∅ flange = 260,00 mm)	REF 144TA4459 (for rubber tracks) (number of teeth = 17) (number of holes = 15)	REF 144TA4464 (front, with bracket assembly) (for rubber tracks)	REF 144TA4372 (rubber) (650 x 110 x 88)
REF 144TA4295 (for rubber tracks) (inner guide) (∅ flange = 296,00 mm)	REF 144TA4458 (assembly) (for rubber tracks) (∅ flange = 174,00 mm)	REF 144TA4461 (for rubber tracks)	REF 144TA4465 (front, with bracket assembly) (for rubber tracks)	REF 144TA4453 (rubber) (450 x 110 x 74)



used for YANMAR				
TRACK ROLLER	TOP ROLLER	SPROCKET	IDLER	TRACK
				
REF 144TA4296 (outer guide) (∅ flange = 270,00 mm) <i>S/N: 00041501 - and up</i>				
REF 144TA4279 (for rubber tracks)	REF 144TA4425 (assembly) (for rubber tracks) (∅ flange = 260,00 mm)	REF 144TA4429 (for rubber tracks) (number of teeth = 17) (number of holes = 15)	REF 144TA4430 (front, with bracket assembly) (for rubber tracks)	REF 144TA4433 (rubber) (450 x 110 x 74)
REF 144TA4294 (for rubber tracks)	REF 144TA4454 (assembly) (for rubber tracks) (∅ flange = 260,00 mm)	REF 144TA4459 (for rubber tracks) (number of teeth = 17) (number of holes = 15)	REF 144TA4464 (front, with bracket assembly) (for rubber tracks)	REF 144TA4372 (rubber) (650 x 110 x 88)
REF 144TA4295 (for rubber tracks) (inner guide) (∅ flange = 296,00 mm)	REF 144TA4458 (assembly) (for rubber tracks) (∅ flange = 174,00 mm)	REF 144TA4461 (for rubber tracks)	REF 144TA4465 (front, with bracket assembly) (for rubber tracks)	REF 144TA4453 (rubber) (450 x 110 x 74)
REF 144TA4296 (outer guide) (∅ flange = 270,00 mm)				
YANMAR C60R				
		REF 144TA4460 (for rubber tracks) (number of teeth = 18) (number of holes = 16)		REF 144TA4470 (rubber) (600 x 100 x 80)
YANMAR C6R				
REF 144TA4264 (∅ flange = 150,00 mm) (∅ body = 65,30 mm)		REF 163TA9573	REF 144TA4412 (front, with bracket assembly) (∅ = 160,00 mm)	REF 144TA4370 (rubber) (230 x 72 x 41)
YANMAR C80R-1				
REF 144TA4296 (outer guide) (∅ flange = 270,00 mm)	REF 144TA4458 (assembly) (for rubber tracks) (∅ flange = 174,00 mm)	REF 144TA4461 (for rubber tracks)	REF 144TA4465 (front, with bracket assembly) (for rubber tracks)	REF 144TA4372 (rubber) (650 x 110 x 88)
REF 144TA4295 (for rubber tracks) (inner guide) (∅ flange = 296,00 mm)				
YANMAR C80R-2				
REF 144TA4293 (for rubber tracks)	REF 144TA4425 (assembly) (for rubber tracks) (∅ flange = 260,00 mm)	REF 144TA4427 (for rubber tracks) (number of teeth = 4) (number of holes = 6)	REF 144TA4426 (front, with bracket assembly) (for rubber tracks)	REF 144TA4380 (rubber) (650 x 120 x 78)
YANMAR C8R				
				REF 144TA4367 (rubber) (230 x 72 x 50)
YANMAR SV05				
REF 144TA4254 (∅ flange = 130,00 mm) (∅ body = 70,00 mm)		REF 144TA4324	REF 144TA4327 (front, with bracket assembly)	REF 144TA1009 (rubber) (180 x 72 x 32)
YANMAR SV05-A				
REF 144TA4280 (∅ flange = 130,00 mm) (∅ body = 70,00 mm)		REF 144TA4326	REF 163TA9662 (front, with bracket assembly)	REF 144TA1009 (rubber) (180 x 72 x 32)
YANMAR SV08				
REF 144TA4254 (∅ flange = 130,00 mm) (∅ body = 70,00 mm)		REF 143TA9253	REF 144TA4401 (front, with bracket assembly)	REF 143TA9993 (rubber) (180 x 72 x 37)
YANMAR SV08-1				
REF 144TA4254 (∅ flange = 130,00 mm) (∅ body = 70,00 mm)		REF 143TA9253	REF 144TA4400 (front, with bracket assembly)	REF 143TA9993 (rubber) (180 x 72 x 37)



used for YANMAR				
TRACK ROLLER	TOP ROLLER	SPROCKET	IDLER	TRACK
				
YANMAR SV08-1A				
REF 163TA9602 (∅ flange = 130,00 mm) (∅ body = 70,00 mm)		REF 163TA9579	REF 163TA9663 (front, with bracket assembly)	REF 143TA9993 (rubber) (180 x 72 x 37)
YANMAR SV100				
REF 163TA9603 (for rubber tracks) (∅ flange = 160,00 mm) (∅ body = 120,00 mm)	REF 163TA9623 (assembly) (for rubber tracks) (∅ body = 105,00 mm)	REF 163TA9580 (for rubber tracks) (number of teeth = 21) (number of holes = 15)	REF 163TA9664 (front, with bracket assembly) (for rubber tracks) (∅ = 508,00 mm)	REF 144TA4361 (rubber) (485 x 92 x 72)
YANMAR SV15				
REF 163TA9604 (∅ flange = 130,00 mm) (∅ body = 70,00 mm)		REF 163TA9581 (number of teeth = 14) (number of holes = 9)	REF 163TA9665 (front, with bracket assembly) (∅ = 295,00 mm)	REF 163TA9566 (rubber) (230 x 72k x 47)
YANMAR SV17				
REF 163TA9604 (∅ flange = 130,00 mm) (∅ body = 70,00 mm)		REF 163TA9581 (number of teeth = 14) (number of holes = 9)	REF 163TA9665 (front, with bracket assembly) (∅ = 295,00 mm)	REF 163TA9566 (rubber) (230 x 72k x 47)
YANMAR SV17EX				
REF 163TA9604 (∅ flange = 130,00 mm) (∅ body = 70,00 mm)		REF 163TA9581 (number of teeth = 14) (number of holes = 9)	REF 163TA9665 (front, with bracket assembly) (∅ = 295,00 mm)	REF 163TA9566 (rubber) (230 x 72k x 47)
YANMAR SV26				
REF 144TA4281 (for asymmetrical rubber tracks) (∅ flange = 140,00 mm) (∅ body = 78,00 mm)	REF 144TA1780 (assembly) (for asymmetrical rubber tracks) (∅ body = 80,00 mm)	REF 144TA4462 (for asymmetrical rubber tracks) (number of teeth = 21) (number of holes = 12)	REF 144TA4467 (front, with bracket assembly) (for asymmetrical rubber tracks)	REF 144TA4471 (rubber) (250 x 55,5 x 79)
YANMAR VIO10				
REF 143TA8703		REF 163TA9582	REF 144TA4444 (front, with bracket assembly)	REF 143TA9811 (rubber) (200 x 72 x 43)
YANMAR VIO10-2				
REF 144TA4254 (∅ flange = 130,00 mm) (∅ body = 70,00 mm)		REF 144TA4346	REF 144TA4400 (front, with bracket assembly)	REF 144TA1011 (rubber) (180 x 72 x 43)
YANMAR VIO10-2A				
REF 144TA4254 (∅ flange = 130,00 mm) (∅ body = 70,00 mm)		REF 144TA4346	REF 144TA4400 (front, with bracket assembly)	REF 144TA1011 (rubber) (180 x 72 x 43)
YANMAR VIO15				
REF 163TA9589 (∅ flange = 129,50 mm) (∅ body = 68,00 mm)		REF 163TA9571 (number of teeth = 14) (number of holes = 9)	REF 144TA4397 (front, with bracket assembly)	REF 164TA3077 (rubber) (230 x 72 x 47)
YANMAR VIO15-1				
REF 163TA9589 (∅ flange = 129,50 mm) (∅ body = 68,00 mm)		REF 163TA9571 (number of teeth = 14) (number of holes = 9)	REF 144TA4397 (front, with bracket assembly)	REF 164TA3077 (rubber) (230 x 72 x 47)
YANMAR VIO15-1EX				
REF 163TA9589 (∅ flange = 129,50 mm) (∅ body = 68,00 mm)		REF 163TA9571 (number of teeth = 14) (number of holes = 9)	REF 144TA4397 (front, with bracket assembly)	REF 164TA3077 (rubber) (230 x 72 x 47)
YANMAR VIO15-2				
REF 164TA2112		REF 163TA9584 (number of teeth = 14) (number of holes = 9)	REF 144TA4397 (front, with bracket assembly)	REF 144TA4355 (rubber) (230 x 72 x 47) (with rail)
YANMAR VIO15-2A				
REF 163TA9604 (∅ flange = 130,00 mm) (∅ body = 70,00 mm)		REF 163TA9581 (number of teeth = 14) (number of holes = 9)	REF 163TA9665 (front, with bracket assembly) (∅ = 295,00 mm)	REF 144TA4355 (rubber) (230 x 72 x 47) (with rail)



used for YANMAR				
TRACK ROLLER	TOP ROLLER	SPROCKET	IDLER	TRACK
				
YANMAR VIO17				
REF 163TA9606 (Ø flange = 130,00 mm) (Ø body = 70,00 mm)		REF 144TA4463 (number of teeth = 13) (number of holes = 8)	REF 143TA9557 (front, with bracket assembly) (Ø = 270,60 mm)	REF 163TA9566 (rubber) (230 x 72k x 47)
YANMAR VIO20				
REF 143TA8727 (Ø flange = 110,00 mm) (Ø body = 70,00 mm)	REF 163TA9625 (assembly)	REF 143TA9161 (number of teeth = 23) (number of holes = 9)	REF 143TA9445 (front, with bracket assembly) (for rubber tracks) REF 143TA9446 (front, with bracket assembly) (for steel tracks)	REF 144TA4339 (rubber) (250 x 48,5 x 84) REF 144TA4472 (rubber) (260 x 96 x 41)
YANMAR VIO20-1				
REF 143TA8727 (Ø flange = 110,00 mm) (Ø body = 70,00 mm)	REF 163TA9625 (assembly)	REF 143TA9161 (number of teeth = 23) (number of holes = 9)	REF 143TA9445 (front, with bracket assembly) (for rubber tracks) REF 143TA9446 (front, with bracket assembly) (for steel tracks)	REF 143TA9850 (rubber) (250 x 48,5 x 84)
YANMAR VIO20-2				
REF 144TA4283 (Ø flange = 110,00 mm) (Ø body = 70,00 mm)	REF 163TA9635 (guide) (for rubber tracks) (plate type) REF 163TA9636 (guide) (for steel tracks) (plate type)	REF 144TA4331 (number of teeth = 23) (number of holes = 9)	REF 144TA4403 (front, with bracket assembly) (for rubber tracks) (Ø = 324,00 mm) REF 163TA9669 (front, with bracket assembly) (for steel tracks)	REF 144TA4339 (rubber) (250 x 48,5 x 84)
YANMAR VIO20-3				
<i>S/P: CF1A</i>				
REF 144TA4283 (Ø flange = 110,00 mm) (Ø body = 70,00 mm)	REF 164TA2122 (assembly)	REF 143TA9161 (number of teeth = 23) (number of holes = 9)	REF 144TA4403 (front, with bracket assembly) (Ø = 324,00 mm)	REF 144TA4339 (rubber) (250 x 48,5 x 84)
<i>S/P: YCE</i>				
REF 144TA4283 (Ø flange = 110,00 mm) (Ø body = 70,00 mm)	REF 163TA9635 (guide) (plate type)	REF 144TA4331 (number of teeth = 23) (number of holes = 9)	REF 144TA4403 (front, with bracket assembly) (Ø = 324,00 mm)	REF 144TA4339 (rubber) (250 x 48,5 x 84)
YANMAR VIO25				
REF 144TA4258 (Ø flange = 140,00 mm) (Ø body = 78,00 mm)	REF 144TA1780 (assembly) (Ø body = 80,00 mm)	REF 164TA3084 (number of teeth = 21) (number of holes = 12)	REF 144TA4404 (front, with bracket assembly) (for rubber tracks) (Ø = 330,00 mm) REF 163TA9645 (front, with bracket assembly) (for steel tracks)	REF 144TA1015 (rubber) (260 x 55,5 x 78) (offset)
YANMAR VIO25-3				
<i>S/P: CG1A</i>				
REF 163TA9591 (Ø flange = 140,00 mm) (Ø body = 78,00 mm)	REF 144TA4351 (assembly) (Ø body = 80,00 mm)	REF 164TA3084 (number of teeth = 21) (number of holes = 12)	REF 144TA4404 (front, with bracket assembly) (for rubber tracks) (Ø = 330,00 mm) REF 163TA9645 (front, with bracket assembly) (for steel tracks)	REF 144TA1015 (rubber) (260 x 55,5 x 78) (offset)



used for YANMAR				
TRACK ROLLER	TOP ROLLER	SPROCKET	IDLER	TRACK
				
YANMAR VIO25-4				
REF 163TA9605 (Ø flange = 140,00 mm) (Ø body = 78,00 mm)	REF 163TA9624 (assembly) (Ø body = 80,00 mm)	REF 164TA3084 (number of teeth = 21) (number of holes = 12)	REF 144TA4404 (front, with bracket assembly) (for rubber tracks) (Ø = 330,00 mm) REF 163TA9645 (front, with bracket assembly) (for steel tracks)	REF 144TA1015 (rubber) (260 x 55,5 x 78) (offset)
YANMAR VIO27				
REF 144TA4258 (Ø flange = 140,00 mm) (Ø body = 78,00 mm)	REF 163TA9626 (assembly) (Ø body = 80,00 mm)	REF 164TA3084 (number of teeth = 21) (number of holes = 12)	REF 163TA9670 (front, with bracket assembly) (for rubber tracks) (Ø = 330,00 mm) REF 163TA9645 (front, with bracket assembly) (for steel tracks)	REF 163TA9567 (rubber) (260 x 55,5 x 78)
YANMAR VIO27-2				
REF 163TA9607 (Ø flange = 140,00 mm) (Ø body = 78,00 mm)	REF 163TA9626 (assembly) (Ø body = 80,00 mm)	REF 164TA3084 (number of teeth = 21) (number of holes = 12)	REF 163TA9670 (front, with bracket assembly) (for rubber tracks) (Ø = 330,00 mm) REF 163TA9645 (front, with bracket assembly) (for steel tracks)	REF 163TA9567 (rubber) (260 x 55,5 x 78)
YANMAR VIO27-3				
REF 144TA4284 (Ø flange = 140,00 mm) (Ø body = 78,00 mm)	REF 144TA4351 (assembly) (Ø body = 80,00 mm)	REF 163TA9585 (number of teeth = 21) (number of holes = 12)	REF 163TA9666 (front, with bracket assembly) (for rubber tracks) (Ø = 330,00 mm) REF 163TA9671 (front, with bracket assembly) (for steel tracks)	REF 163TA9567 (rubber) (260 x 55,5 x 78)
YANMAR VIO30				
REF 163TA9591 (Ø flange = 140,00 mm) (Ø body = 78,00 mm)	REF 143TA8951 (assembly) (Ø body = 80,00 mm)	REF 163TA9572 (number of teeth = 21) (number of holes = 11)	REF 144TA4398 (front, with bracket assembly) (Ø = 332,00 mm)	REF 144TA4332 (rubber) (300 x 55,5 x 82) REF 164TA3078 (rubber) (320 x 106 x 39)
YANMAR VIO30-1				
REF 163TA9591 (Ø flange = 140,00 mm) (Ø body = 78,00 mm)	REF 143TA8951 (assembly) (Ø body = 80,00 mm)	REF 163TA9572 (number of teeth = 21) (number of holes = 11)	REF 144TA4398 (front, with bracket assembly) (Ø = 332,00 mm)	REF 144TA4340 (rubber) (300 x 55,5 x 82)
YANMAR VIO30-2				
REF 163TA9607 (Ø flange = 140,00 mm) (Ø body = 78,00 mm)	REF 144TA4351 (assembly) (Ø body = 80,00 mm)	REF 163TA9572 (number of teeth = 21) (number of holes = 11)	REF 163TA9645 (front, with bracket assembly) (for steel tracks) REF 144TA4404 (front, with bracket assembly) (for rubber tracks) (Ø = 330,00 mm)	REF 144TA4340 (rubber) (300 x 55,5 x 82)

TRACKS & UNDERCARRIAGE PARTS



used for YANMAR

used for YANMAR				
TRACK ROLLER	TOP ROLLER	SPROCKET	IDLER	TRACK
				
YANMAR VIO30-3				
<i>S/P: DD2B5</i>				
REF 163TA9591 (Ø flange = 140,00 mm) (Ø body = 78,00 mm)	REF 144TA4351 (assembly) (Ø body = 80,00 mm)	REF 163TA9572 (number of teeth = 21) (number of holes = 11)	REF 144TA4404 (front, with bracket assembly) (for rubber tracks) (Ø = 330,00 mm) REF 163TA9645 (front, with bracket assembly) (for steel tracks)	REF 144TA4340 (rubber) (300 x 55,5 x 82)
YANMAR VIO35				
REF 143TA8733 (Ø flange = 140,00 mm) (Ø body = 78,00 mm)	REF 144TA1780 (assembly) (Ø body = 80,00 mm)	REF 163TA9583 (number of teeth = 21) (number of holes = 11)	REF 143TA4283 (front, with bracket assembly) (Ø = 330,00 mm)	REF 144TA4340 (rubber) (300 x 55,5 x 82)
YANMAR VIO35-1				
	REF 144TA1780 (assembly) (for asymmetrical rubber tracks) (Ø body = 80,00 mm)			REF 144TA4340 (rubber) (300 x 55,5 x 82)
YANMAR VIO35-2				
REF 163TA9591 (Ø flange = 140,00 mm) (Ø body = 78,00 mm)	REF 144TA4351 (assembly) (Ø body = 80,00 mm)	REF 144TA4315 (number of teeth = 21) (number of holes = 11)	REF 163TA9666 (front, with bracket assembly) (Ø = 330,00 mm)	REF 144TA4340 (rubber) (300 x 55,5 x 82)
YANMAR VIO35-3				
<i>S/P: DE2B5</i>				
REF 163TA9591 (Ø flange = 140,00 mm) (Ø body = 78,00 mm)	REF 144TA4351 (assembly) (Ø body = 80,00 mm)	REF 163TA9572 (number of teeth = 21) (number of holes = 11)	REF 144TA4404 (front, with bracket assembly) (for rubber tracks) (Ø = 330,00 mm) REF 163TA9645 (front, with bracket assembly) (for steel tracks)	REF 144TA1016 (rubber) (300 x 55,5 x 82)
YANMAR VIO35-5				
REF 163TA9605 (Ø flange = 140,00 mm) (Ø body = 78,00 mm)	REF 163TA9624 (assembly) (Ø body = 80,00 mm)	REF 163TA9583 (number of teeth = 21) (number of holes = 11)	REF 163TA9667 (front, with bracket assembly) (for rubber tracks) REF 164TA2152 (front, with bracket assembly) (for steel tracks)	REF 144TA4340 (rubber) (300 x 55,5 x 82)
YANMAR VIO40				
REF 163TA9608	REF 143TA8954 (assembly)	REF 163TA9574	REF 143TA9470 (front, with bracket assembly)	REF 143TA9878 (rubber) (400 x 107 x 46)
YANMAR VIO40-1				
REF 163TA9595 (Ø flange = 159,50 mm) (Ø body = 111,00 mm)	REF 144TA4356 (assembly) (Ø body = 80,00 mm)	REF 163TA9575 (number of teeth = 19) (number of holes = 9)	REF 163TA9657 (front, with bracket assembly) (for rubber tracks) REF 163TA9672 (front, with bracket assembly) (for steel tracks)	REF 144TA4341 (rubber) (350 x 75,5 x 74) (offset)
YANMAR VIO40-2				
REF 144TA4285 (Ø flange = 159,50 mm) (Ø body = 111,00 mm)	REF 144TA4338 (assembly) (Ø body = 80,00 mm)	REF 144TA4305 (number of teeth = 19) (number of holes = 9)	REF 144TA4405 (front, with bracket assembly) (Ø = 381,00 mm)	REF 163TA9568 (rubber) (350 x 75,5 x 74) (offset)



used for YANMAR				
TRACK ROLLER	TOP ROLLER	SPROCKET	IDLER	TRACK
				
YANMAR VIO40-5				
				REF 144TA9279 (rubber) (400 x 73 x 76)
YANMAR VIO40-V				
REF 144TA4260 (for asymmetrical rubber tracks) (Ø flange = 159,50 mm) (Ø body = 111,00 mm)		REF 144TA4306 (for asymmetrical rubber tracks) (number of teeth = 19) (number of holes = 9)		REF 144TA4473 (rubber) (400 x 107 x 46)
YANMAR VIO45				
<i>S/N: up to - 00022169</i>				
REF 144TA4285 (Ø flange = 159,50 mm) (Ø body = 111,00 mm)	REF 144TA4356 (assembly) (Ø body = 80,00 mm)	REF 163TA9575 (number of teeth = 19) (number of holes = 9)	REF 163TA9673 (front, with bracket assembly) (Ø = 381,00 mm)	REF 163TA9569 (rubber) (350 x 75,5 x 74)
<i>S/N: 00022170 - and up</i>				
REF 163TA9609	REF 144TA4356 (assembly) (Ø body = 80,00 mm)	REF 163TA9575 (number of teeth = 19) (number of holes = 9)	REF 163TA9673 (front, with bracket assembly) (Ø = 381,00 mm)	REF 163TA9569 (rubber) (350 x 75,5 x 74)
<i>S/P: EA1A</i>				
REF 163TA9610 (Ø flange = 159,50 mm) (Ø body = 111,00 mm)	REF 144TA4356 (assembly) (Ø body = 80,00 mm)	REF 163TA9575 (number of teeth = 19) (number of holes = 9)	REF 163TA9674 (front, with bracket assembly) (Ø = 381,00 mm) REF 163TA9673 (front, with bracket assembly) (Ø = 381,00 mm)	REF 144TA4341 (rubber) (350 x 75,5 x 74) (offset) REF 163TA9569 (rubber) (350 x 75,5 x 74)
<i>S/P: EA2B</i>				
REF 163TA9610 (Ø flange = 159,50 mm) (Ø body = 111,00 mm)	REF 144TA4356 (assembly) (Ø body = 80,00 mm)	REF 163TA9575 (number of teeth = 19) (number of holes = 9)	REF 163TA9674 (front, with bracket assembly) (Ø = 381,00 mm) REF 163TA9673 (front, with bracket assembly) (Ø = 381,00 mm)	REF 144TA4341 (rubber) (350 x 75,5 x 74) (offset) REF 163TA9569 (rubber) (350 x 75,5 x 74)
YANMAR VIO45-3				
<i>S/P: EA2B</i>				
				REF 144TA4341 (rubber) (350 x 75,5 x 74) (offset)
YANMAR VIO45-5				
REF 163TA9610 (Ø flange = 159,50 mm) (Ø body = 111,00 mm)	REF 163TA9627 (assembly) (Ø body = 80,00 mm)	REF 163TA9575 (number of teeth = 19) (number of holes = 9)	REF 163TA9673 (front, with bracket assembly) (Ø = 381,00 mm)	REF 144TA4341 (rubber) (350 x 75,5 x 74) (offset)
YANMAR VIO45-5B				
REF 163TA9610 (Ø flange = 159,50 mm) (Ø body = 111,00 mm)	REF 163TA9627 (assembly) (Ø body = 80,00 mm)	REF 163TA9575 (number of teeth = 19) (number of holes = 9)	REF 163TA9673 (front, with bracket assembly) (Ø = 381,00 mm)	REF 144TA4341 (rubber) (350 x 75,5 x 74) (offset)
YANMAR VIO45-6				
				REF 144TA9280 (rubber) (350 x 73Y x 76)
YANMAR VIO45-V				
REF 144TA4260 (for asymmetrical rubber tracks) (Ø flange = 159,50 mm) (Ø body = 111,00 mm)	REF 143TA8958 (assembly) (for asymmetrical rubber tracks) (Ø body = 80,00 mm)	REF 144TA4306 (for asymmetrical rubber tracks) (number of teeth = 19) (number of holes = 9)	REF 144TA4405 (front, with bracket assembly) (for asymmetrical rubber tracks) (Ø = 381,00 mm)	REF 144TA4341 (rubber) (350 x 75,5 x 74) (offset)

TRACKS & UNDERCARRIAGE PARTS



used for YANMAR

used for YANMAR				
TRACK ROLLER	TOP ROLLER	SPROCKET	IDLER	TRACK
				
YANMAR VI050				
REF 163TA9595 (Ø flange = 159,50 mm) (Ø body = 111,00 mm)	REF 143TA8958 (assembly) (Ø body = 80,00 mm)	REF 163TA9575 (number of teeth = 19) (number of holes = 9)	REF 143TA9480 (front, with bracket assembly) (for rubber tracks) REF 143TA9471 (front, with bracket assembly) (for steel tracks) (Ø = 375,00 mm)	REF 144TA4320 (rubber) (400 x 144 x 36)
YANMAR VI050-1				
REF 163TA9595 (Ø flange = 159,50 mm) (Ø body = 111,00 mm)	REF 163TA9628 (assembly) (Ø body = 80,00 mm)	REF 163TA9575 (number of teeth = 19) (number of holes = 9)	REF 163TA9657 (front, with bracket assembly) (for rubber tracks) REF 143TA9471 (front, with bracket assembly) (for steel tracks) (Ø = 375,00 mm)	REF 144TA4343 (rubber) (400 x 75,5 x 74) (offset)
YANMAR VI050-2				
REF 144TA4285 (Ø flange = 159,50 mm) (Ø body = 111,00 mm)	REF 163TA9629 (assembly)	REF 144TA4305 (number of teeth = 19) (number of holes = 9)	REF 144TA4405 (front, with bracket assembly) (Ø = 381,00 mm)	REF 144TA1003 (rubber) (400 x 75,5 x 74) (offset)
YANMAR VI050CR				
REF 144TA4260 (for rubber tracks) (Ø flange = 159,50 mm) (Ø body = 111,00 mm)		REF 144TA4306 (for rubber tracks) (number of teeth = 19) (number of holes = 9)		REF 144TA4469 (rubber) (400 x 144 x 36)
YANMAR VI050PR				
REF 144TA4260 (for rubber tracks) (Ø flange = 159,50 mm) (Ø body = 111,00 mm)		REF 144TA4306 (for rubber tracks) (number of teeth = 19) (number of holes = 9)		REF 144TA4469 (rubber) (400 x 144 x 36)
YANMAR VI050U				
REF 163TA9610 (Ø flange = 159,50 mm) (Ø body = 111,00 mm)	REF 163TA9627 (assembly) (Ø body = 80,00 mm)	REF 163TA9586 (number of teeth = 19) (number of holes = 9)	REF 163TA9675 (front, with bracket assembly) (Ø = 381,00 mm)	REF 144TA4341 (rubber) (350 x 75,5 x 74) (offset)
YANMAR VI050-V				
REF 144TA4260 (for rubber tracks) (Ø flange = 159,50 mm) (Ø body = 111,00 mm)		REF 144TA4306 (for rubber tracks) (number of teeth = 19) (number of holes = 9)		REF 144TA4469 (rubber) (400 x 144 x 36)
YANMAR VI055				
<i>S/N: up to - 00021881</i>				
REF 144TA4285 (Ø flange = 159,50 mm) (Ø body = 111,00 mm)	REF 144TA4356 (assembly) (Ø body = 80,00 mm) REF 163TA9622 (assembly) (Ø flange = 130,00 mm) (Ø body = 87,00 mm)	REF 163TA9575 (number of teeth = 19) (number of holes = 9)	REF 163TA9676 (front, with bracket assembly) (Ø = 381,00 mm) REF 144TA4405 (front, with bracket assembly) (for rubber tracks) (Ø = 381,00 mm)	REF 144TA4343 (rubber) (400 x 75,5 x 74) (offset)
<i>S/N: 00021882 - and up</i>				
REF 163TA9609	REF 144TA4356 (assembly) (Ø body = 80,00 mm)	REF 163TA9575 (number of teeth = 19) (number of holes = 9)	REF 163TA9676 (front, with bracket assembly) (Ø = 381,00 mm)	REF 144TA4343 (rubber) (400 x 75,5 x 74) (offset)



used for YANMAR				
TRACK ROLLER	TOP ROLLER	SPROCKET	IDLER	TRACK
				
	REF 163TA9622 (assembly) (Ø flange = 130,00 mm) (Ø body = 87,00 mm)		REF 144TA4405 (front, with bracket assembly) (for rubber tracks) (Ø = 381,00 mm)	
<i>S/P: FA1A</i>				
REF 163TA9610 (Ø flange = 159,50 mm) (Ø body = 111,00 mm)	REF 144TA4356 (assembly) (Ø body = 80,00 mm)	REF 163TA9575 (number of teeth = 19) (number of holes = 9)	REF 163TA9676 (front, with bracket assembly) (Ø = 381,00 mm)	REF 144TA4343 (rubber) (400 x 75,5 x 74) (offset)
	REF 163TA9622 (assembly) (Ø flange = 130,00 mm) (Ø body = 87,00 mm)		REF 144TA4405 (front, with bracket assembly) (for rubber tracks) (Ø = 381,00 mm)	
<i>S/P: FA2B</i>				
REF 163TA9610 (Ø flange = 159,50 mm) (Ø body = 111,00 mm)	REF 144TA4356 (assembly) (Ø body = 80,00 mm)	REF 163TA9575 (number of teeth = 19) (number of holes = 9)	REF 163TA9676 (front, with bracket assembly) (Ø = 381,00 mm)	REF 144TA4343 (rubber) (400 x 75,5 x 74) (offset)
	REF 163TA9622 (assembly) (Ø flange = 130,00 mm) (Ø body = 87,00 mm)		REF 144TA4405 (front, with bracket assembly) (for rubber tracks) (Ø = 381,00 mm)	
YANMAR VI055-2A				
REF 163TA9611	REF 163TA9630 (assembly) (Ø body = 80,00 mm)	REF 163TA9575 (number of teeth = 19) (number of holes = 9)	REF 163TA9677 (front, with bracket assembly) (Ø = 381,00 mm)	
YANMAR VI055-3				
<i>S/P: FA2B</i>				
REF 144TA4286 (for rubber tracks) (Ø flange = 159,50 mm) (Ø body = 111,00 mm)	REF 144TA4356 (assembly) (Ø body = 80,00 mm)	REF 144TA4305 (for rubber tracks) (number of teeth = 19) (number of holes = 9)	REF 144TA4352 (front, with bracket assembly) (for rubber tracks)	REF 144TA4343 (rubber) (400 x 75,5 x 74) (offset)
YANMAR VI055-3A				
REF 163TA9611	REF 163TA9630 (assembly) (Ø body = 80,00 mm)	REF 163TA9575 (number of teeth = 19) (number of holes = 9)	REF 163TA9677 (front, with bracket assembly) (Ø = 381,00 mm)	
YANMAR VI055-5				
REF 163TA9610 (Ø flange = 159,50 mm) (Ø body = 111,00 mm)	REF 163TA9627 (assembly) (Ø body = 80,00 mm)	REF 163TA9575 (number of teeth = 19) (number of holes = 9)	REF 163TA9676 (front, with bracket assembly) (Ø = 381,00 mm)	REF 144TA4343 (rubber) (400 x 75,5 x 74) (offset)
YANMAR VI055-5B				
REF 163TA9610 (Ø flange = 159,50 mm) (Ø body = 111,00 mm)	REF 163TA9627 (assembly) (Ø body = 80,00 mm)	REF 163TA9575 (number of teeth = 19) (number of holes = 9)	REF 163TA9676 (front, with bracket assembly) (Ø = 381,00 mm)	REF 144TA4343 (rubber) (400 x 75,5 x 74) (offset)
YANMAR VI055-6				
				REF 144TA9279 (rubber) (400 x 73 x 76)
YANMAR VI057-U				
REF 163TA9610 (Ø flange = 159,50 mm) (Ø body = 111,00 mm)	REF 163TA9631 (assembly) (Ø body = 80,00 mm)	REF 163TA9586 (number of teeth = 19) (number of holes = 9)	REF 163TA9675 (front, with bracket assembly) (Ø = 381,00 mm)	REF 144TA4343 (rubber) (400 x 75,5 x 74) (offset)
YANMAR VI070				
REF 143TA8770 (Ø flange = 155,00 mm) (Ø body = 122,00 mm)	REF 144TA4356 (assembly) (Ø body = 80,00 mm)	REF 163TA9576 (number of teeth = 19) (number of holes = 12)	REF 143TA9561 (front, with bracket assembly) (for rubber tracks) (Ø = 418,00 mm)	REF 143TA9893 (rubber) (450 x 75,5 x 84)

TRACKS & UNDERCARRIAGE PARTS



used for YANMAR

used for YANMAR				
TRACK ROLLER	TOP ROLLER	SPROCKET	IDLER	TRACK
				
			REF 143TA9490 (front, with bracket assembly) (for steel tracks)	
YANMAR VIO70-2				
REF 163TA9612	REF 163TA9632 (assembly) (Ø body = 80,00 mm)	REF 163TA9587	REF 163TA9678 (front, with bracket assembly) (Ø = 418,00 mm)	REF 144TA4350 (rubber) (450 x 83,5 x 74) (offset)
YANMAR VIO70-A				
			REF 143TA9561 (front, with bracket assembly) (for rubber tracks) (Ø = 418,00 mm)	REF 144TA4474 (rubber) (450 x 81 x 76)
YANMAR VIO70CR				
			REF 143TA9561 (front, with bracket assembly) (for rubber tracks) (Ø = 418,00 mm)	REF 144TA4474 (rubber) (450 x 81 x 76)
YANMAR VIO75				
REF 144TA4261 (Ø flange = 176,00 mm) (Ø body = 120,00 mm)	REF 144TA4356 (assembly) (Ø body = 80,00 mm)	REF 163TA9576 (number of teeth = 19) (number of holes = 12)	REF 144TA4407 (front, with bracket assembly) (Ø = 418,00 mm)	REF 144TA4350 (rubber) (450 x 83,5 x 74) (offset)
YANMAR VIO75-A				
<i>S/N: up to - 00011681</i>				
REF 144TA4261 (Ø flange = 176,00 mm) (Ø body = 120,00 mm)	REF 144TA4356 (assembly) (Ø body = 80,00 mm)	REF 163TA9577 (number of teeth = 19) (number of holes = 12)	REF 163TA9659 (front, with bracket assembly) (Ø = 418,00 mm)	REF 144TA4350 (rubber) (450 x 83,5 x 74) (offset)
<i>S/N: 00011682 - and up</i>				
REF 144TA4262	REF 144TA4356 (assembly) (Ø body = 80,00 mm)	REF 163TA9577 (number of teeth = 19) (number of holes = 12)	REF 163TA9659 (front, with bracket assembly) (Ø = 418,00 mm)	REF 144TA4350 (rubber) (450 x 83,5 x 74) (offset)
YANMAR VIO80				
REF 163TA9613	REF 151TA2999 (assembly) (Ø body = 80,00 mm)	REF 163TA9588	REF 163TA9659 (front, with bracket assembly) (Ø = 418,00 mm)	REF 144TA4357 (rubber) (450 x 83,5 x 74)
YANMAR YB10				
			REF 144TA4419 (front, with bracket assembly) (for rubber tracks) (Ø = 286,00 mm)	REF 143TA9994 (rubber) (200 x 72 x 47)
YANMAR YB101				
REF 163TA9589 (Ø flange = 129,50 mm) (Ø body = 68,00 mm)		REF 144TA4311	REF 144TA4387 (front, with bracket assembly)	REF 144TA4312 (rubber) (200 x 72 x 39)
YANMAR YB101-UZ				
REF 163TA9589 (Ø flange = 129,50 mm) (Ø body = 68,00 mm)		REF 144TA4311	REF 144TA4387 (front, with bracket assembly)	REF 144TA4312 (rubber) (200 x 72 x 39)
YANMAR YB10-2				
REF 144TA4287		REF 164TA2087 (for steel tracks) REF 144TA4420 (for rubber tracks) (number of teeth = 14) (number of holes = 9)	REF 144TA4419 (front, with bracket assembly) (Ø = 286,00 mm)	REF 144TA4431 (rubber) (230 x 72 x 43)



used for YANMAR				
TRACK ROLLER	TOP ROLLER	SPROCKET	IDLER	TRACK
				
YANMAR YB121				
REF 163TA9589 (Ø flange = 129,50 mm) (Ø body = 68,00 mm)		REF 163TA9571 (for rubber tracks) (number of teeth = 14) (number of holes = 9) REF 163TA9570 (for steel tracks)	REF 143TA9545 (front, with bracket assembly) (Ø = 282,00 mm)	REF 144TA4314 (rubber) (230 x 72 x 43)
YANMAR YB121-U				
REF 163TA9589 (for rubber tracks) (Ø flange = 129,50 mm) (Ø body = 68,00 mm)		REF 163TA9571 (for rubber tracks) (number of teeth = 14) (number of holes = 9) REF 163TA9570 (for steel tracks)	REF 143TA9545 (front, with bracket assembly) (for rubber tracks) (Ø = 282,00 mm)	REF 144TA4314 (rubber) (230 x 72 x 43)
YANMAR YB121-U2				
REF 163TA9589 (for rubber tracks) (Ø flange = 129,50 mm) (Ø body = 68,00 mm)		REF 163TA9571 (for rubber tracks) (number of teeth = 14) (number of holes = 9) REF 163TA9570 (for steel tracks)	REF 143TA9545 (front, with bracket assembly) (for rubber tracks) (Ø = 282,00 mm)	REF 144TA4314 (rubber) (230 x 72 x 43)
YANMAR YB151				
REF 163TA9589 (Ø flange = 129,50 mm) (Ø body = 68,00 mm)		REF 163TA9571 (for rubber tracks) (number of teeth = 14) (number of holes = 9) REF 163TA9570 (for steel tracks)	REF 143TA9545 (front, with bracket assembly) (Ø = 282,00 mm)	REF 144TA4314 (rubber) (230 x 72 x 43)
YANMAR YB151-U				
REF 163TA9589 (Ø flange = 129,50 mm) (Ø body = 68,00 mm)		REF 163TA9571 (for rubber tracks) (number of teeth = 14) (number of holes = 9) REF 163TA9570 (for steel tracks)	REF 143TA9545 (front, with bracket assembly) (Ø = 282,00 mm)	REF 144TA4314 (rubber) (230 x 72 x 43)
YANMAR YB151-U2				
REF 163TA9589 (Ø flange = 129,50 mm) (Ø body = 68,00 mm)		REF 163TA9571 (for rubber tracks) (number of teeth = 14) (number of holes = 9) REF 163TA9570 (for steel tracks)	REF 143TA9545 (front, with bracket assembly) (Ø = 282,00 mm)	REF 144TA4314 (rubber) (230 x 72 x 43)
YANMAR YB201				
REF 144TA4288 (for steel tracks)		REF 164TA2088 (for rubber tracks)	REF 144TA4422 (front, with bracket assembly) (for steel tracks)	REF 144TA4432 (rubber) (320 x 100 x 38)
REF 164TA2558 (for rubber tracks) (Ø flange = 150,00 mm) (Ø body = 75,00 mm)		REF 144TA4421 (for steel tracks)	REF 164TA2153 (front, with bracket assembly) (for rubber tracks)	
YANMAR YB201-U				
REF 144TA4288 (for steel tracks)		REF 144TA4421 (for steel tracks)	REF 144TA4422 (front, with bracket assembly) (for steel tracks)	REF 144TA4432 (rubber) (320 x 100 x 38)





TRACKS & UNDERCARRIAGE PARTS



used for YANMAR

used for YANMAR				
TRACK ROLLER	TOP ROLLER	SPROCKET	IDLER	TRACK
				
REF 164TA2558 (for rubber tracks) (Ø flange = 150,00 mm) (Ø body = 75,00 mm)		REF 164TA2088 (for rubber tracks)	REF 164TA2153 (front, with bracket assembly) (for rubber tracks)	
YANMAR YB271				
<i>S/N: up to - 00010801</i>				
REF 163TA9614 (outer guide)	REF 163TA9618 (assembly) (Ø body = 80,00 mm) (length = 166,00 mm) (flat)	REF 144TA4456 (number of teeth = 12) (number of holes = 9)	REF 144TA4389 (front, with bracket assembly) (Ø = 330,00 mm)	REF 144TA4316 (rubber) (320 x 106 x 39)
REF 163TA9593 (inner guide)	REF 144TA4386 (assembly) (inner guide)	REF 143TA9173 (number of teeth = 21) (number of holes = 11)	REF 163TA9644 (front, with bracket assembly)	REF 144TA4457 (rubber) (320 x 100 x 42)
<i>S/N: 00010802 - and up</i>				
REF 143TA8733 (outer guide) (Ø flange = 140,00 mm) (Ø body = 78,00 mm)	REF 163TA9619 (assembly) (outer guide)	REF 144TA4456 (number of teeth = 12) (number of holes = 9) REF 143TA9173 (number of teeth = 21) (number of holes = 11)	REF 144TA4389 (front, with bracket assembly) (Ø = 330,00 mm) REF 163TA9644 (front, with bracket assembly)	REF 144TA4316 (rubber) (320 x 106 x 39) REF 144TA4457 (rubber) (320 x 100 x 42)
YANMAR YB301				
REF 163TA9615 (for steel tracks)	REF 163TA9620 (assembly) (for rubber tracks) (Ø body = 80,00 mm)	REF 143TA9269 (for steel tracks)	REF 163TA9649 (front, with bracket assembly) (for steel tracks)	REF 144TA4308 (rubber) (320 x 100 x 43)
REF 163TA9616 (for rubber tracks)		REF 144TA4307 (for rubber tracks) (number of teeth = 12) (number of holes = 9)	REF 144TA4385 (front, with bracket assembly) (for rubber tracks)	
YANMAR YB301-1				
REF 163TA9615 (for steel tracks)		REF 143TA9269 (for steel tracks)	REF 163TA9649 (front, with bracket assembly) (for steel tracks)	REF 144TA4308 (rubber) (320 x 100 x 43)
REF 163TA9616 (for rubber tracks)		REF 144TA4307 (for rubber tracks) (number of teeth = 12) (number of holes = 9)	REF 144TA4385 (front, with bracket assembly) (for rubber tracks)	
YANMAR YB351				
REF 163TA9615 (for steel tracks)		REF 143TA9269 (for steel tracks)	REF 163TA9649 (front, with bracket assembly) (for steel tracks)	REF 144TA4308 (rubber) (320 x 100 x 43)
REF 163TA9616 (for rubber tracks)		REF 144TA4307 (for rubber tracks) (number of teeth = 12) (number of holes = 9)	REF 144TA4385 (front, with bracket assembly) (for rubber tracks)	
YANMAR YB351-1				
REF 163TA9615 (for steel tracks)		REF 143TA9269 (for steel tracks)	REF 163TA9649 (front, with bracket assembly) (for steel tracks)	REF 144TA4308 (rubber) (320 x 100 x 43)
REF 163TA9616 (for rubber tracks)		REF 144TA4307 (for rubber tracks) (number of teeth = 12) (number of holes = 9)	REF 144TA4385 (front, with bracket assembly) (for rubber tracks)	







used for YANMAR				
TRACK ROLLER	TOP ROLLER	SPROCKET	IDLER	TRACK
				
YANMAR YB451				
REF 163TA9617 (for steel tracks)	REF 144TA4455 (assembly) (for steel tracks)	REF 163TA9575 (for steel tracks) (number of teeth = 19) (number of holes = 9)	REF 144TA4309 (front, with bracket assembly) (for steel tracks)	REF 144TA4310 (rubber) (400 x 100 x 52)
REF 143TA8874 (for rubber tracks) (outer guide)	REF 143TA9008 (assembly) (for rubber tracks)	REF 143TA9270 (for rubber tracks)	REF 143TA9563 (front, with bracket assembly) (for rubber tracks)	
REF 143TA8853 (for rubber tracks) (inner guide)				
YANMAR YB501				
REF 163TA9617 (for steel tracks)	REF 144TA4455 (assembly) (for steel tracks)	REF 163TA9575 (for steel tracks) (number of teeth = 19) (number of holes = 9)	REF 144TA4309 (front, with bracket assembly) (for steel tracks)	REF 144TA4310 (rubber) (400 x 100 x 52)
REF 143TA8874 (for rubber tracks) (outer guide)	REF 143TA9008 (assembly) (for rubber tracks)	REF 143TA9270 (for rubber tracks)	REF 143TA9563 (front, with bracket assembly) (for rubber tracks)	
REF 143TA8853 (for rubber tracks) (inner guide)				



USED FOR
YGRY



used for YGRY

used for YGRY				
TRACK ROLLER	TOP ROLLER	SPROCKET	IDLER	TRACK
				
YGRY SA140			REF 143TA9380 (with bracket assembly) (for rubber tracks) (Ø = 286,00 mm)	REF 164TA3075 (rubber) (230 x 72 x 43)
YGRY Y12				
REF 143TA8803 (for rubber tracks) (Ø flange = 129,50 mm) (Ø body = 68,00 mm)				REF 164TA3090 (rubber) (230 x 72 x 43)
YGRY Y12B				
REF 143TA8803 (for rubber tracks) (Ø flange = 129,50 mm) (Ø body = 68,00 mm)				REF 164TA3090 (rubber) (230 x 72 x 43)



USED FOR
YUCHAI



used for YUCHAI

used for **YUCHAI**

TRACK ROLLER 	TOP ROLLER 	SPROCKET 	IDLER 	TRACK 
---	---	---	--	--

YUCHAI YC35

REF 144TA7235
(for steel tracks)

REF 143TA9009
(assembly) (for steel tracks)

YUCHAI YC55

REF 144TA7236
(for rubber tracks) (inner guide) (Ø flange = 120,00 mm) (Ø body = 95,00 mm)

YUCHAI YC85

REF 144TA7237
(for rubber tracks) (outer guide) (Ø flange = 188,00 mm) (Ø body = 135,00 mm)

REF 144TA7241
(for steel tracks) (Ø flange = 155,00 mm) (Ø body = 121,00 mm)

REF 144TA7240
(for rubber tracks) (outer guide) (Ø flange = 155,00 mm) (Ø body = 121,00 mm)

REF 144TA7242
(assembly) (for steel tracks) (Ø flange = 120,00 mm) (Ø body = 90,70 mm)

REF 144TA7238
(assembly) (for rubber tracks) (Ø flange = 120,00 mm) (Ø body = 90,70 mm)

REF 143TA9271
(for rubber and steel tracks)

REF 144TA7243
(front, with bracket assembly) (for steel tracks) (Ø = 408,00 mm)

REF 144TA7239
(front, with bracket assembly) (for rubber tracks) (Ø = 408,00 mm)

REF 144TA1021
(rubber) (450 x 76 x 80)



MAINTENANCE, REPAIR & OPERATION



UNIVERSAL 3-JAW PULLER



Universal 3-jaw puller with long hydraulic spindle

		Max t		REF
160 mm	150 mm	7	1	143TA5945
200 mm	150 mm	7	1	143TA5946
250 mm	200 mm	10	1	143TA5947
350 mm	200 mm	10	1	143TA5948

1" LONG HEXAGON IMPACT SOCKETS - METRIC



Size	Beta		Elora	
	Length	REF	Length	REF
21 mm			110 mm	142TA5745
22 mm			110 mm	142TA5746
24 mm	108 mm	143TA3727	110 mm	142TA5747
27 mm	108 mm	143TA3728	110 mm	142TA5748
30 mm	108 mm	143TA3729	110 mm	142TA5749
32 mm	108 mm	143TA3730	110 mm	142TA5750
33 mm	108 mm	143TA3731	110 mm	142TA5751
34 mm	108 mm	143TA3732	110 mm	142TA5752
36 mm	108 mm	143TA3733	110 mm	142TA5753
38 mm			110 mm	142TA5754
41 mm	108 mm	143TA3734	110 mm	142TA5755
46 mm	108 mm	143TA3735	110 mm	142TA5756
50 mm	108 mm	143TA3736	110 mm	142TA5757
55 mm	108 mm	143TA3737		
60 mm	108 mm	143TA3738	110 mm	142TA5758
65 mm	108 mm	143TA3739		
70 mm	108 mm	143TA3740		
75 mm	108 mm	143TA3741		
80 mm	108 mm	143TA3742		





11 PIECE 3/4" HEXAGON IMPACT SOCKET SET – METRIC



REF 142TA7350

Contents:

11 hexagon impact sockets: 17 – 19 – 22 – 24 – 27 – 30 – 32 – 36 – 41 – 46 – 50 mm



IMPACT WRENCH

REF 143TA7480

- Square drive: 3/4"
- Working torque wrench: 1100 Nm
- Max torque wrench: 1500 Nm
- Free speed: 5600 rpm
- Weight: 4,7 kg
- Average air consumption: 212 l/min



**Force professional tools
Special**

REF 22835159



PORTABLE HYDRAULIC JACKS

Characteristics:

- The base, cylinder and reservoir form a compact unit
- Absorbs the lateral force, generated by the tilt of the axle of the vehicle at the moment of lifting. As there is no contact between the piston and the cylinder, these cannot seize
- Suitable for horizontal and vertical use
- Repair kits available for all models

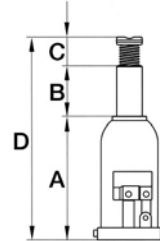

Capacity	A	B	C	D	Weight	REF	REF repair kit
2 tonne	160 mm	100 mm	50 mm	310 mm	3,6 kg	143TA5468	143TA5506
3 tonne	168 mm	105 mm	65 mm	338 mm	3,9 kg	143TA5469	143TA5512
3 tonne	210 mm	150 mm	65 mm	425 mm	4,2 kg	143TA5470	143TA5513
5 tonne	212 mm	150 mm	75 mm	437 mm	5 kg	143TA5471	143TA5507
8 tonne	219 mm	150 mm	75 mm	444 mm	5,9 kg	143TA5472	143TA5514
10 tonne	219 mm	150 mm	75 mm	444 mm	6,5 kg	143TA5473	143TA5511
10 tonne	131 mm	62 mm	30 mm	223 mm	6,5 kg	143TA5467	143TA5511
12 tonne	226 mm	150 mm	75 mm	451 mm	8 kg	143TA5463	143TA5508
15 tonne	228 mm	150 mm	75 mm	453 mm	9 kg	143TA5464	143TA5515
20 tonne	234 mm	150 mm	75 mm	459 mm	12,1 kg	143TA5465	143TA5509
25 tonne	240 mm	150 mm	75 mm	465 mm	15 kg	143TA5474	143TA5516
30 tonne	242 mm	150 mm	75 mm	467 mm	15,5 kg	143TA5466	143TA5510
40 tonne	246 mm	150 mm		396 mm	23,5 kg	143TA5475	143TA5517
50 tonne	252 mm	150 mm		402 mm	28,5 kg	143TA5476	
50 tonne	270 mm	150 mm		420 mm	40 kg	143TA5477	143TA5518
100 tonne	300 mm	150 mm		450 mm	87 kg	143TA5478	143TA5519



Jacks & supports Special

REF 18178749



FLEXIBLE DRAINING TOOL

REF [139TA6262](#)

- For draining & pouring of liquids in applications where rigid funnels are too big
- Bends, molds & holds any shape
- Leakproof
- As versatile in dry as in wet applications
- Store flat or roll up to take along in your toolbox or glove compartment
- 100% aluminium permanently sealed inside of a heavy coating of flexible nitrile rubber
- Dimensions: 370 x 165 mm
- Bend sides to create a small parts tray, scoop & much more
- Works in temperatures from -34 °C to 218 °C



REF [143TA6515](#)

Dimensions: 370 x 170 mm

REF [143TA6516](#)

Dimensions: 410 x 200 mm

POLYETHYLENE FUNNEL WITH CAP

REF [107TA7277](#)

- Capacity: 3,2 l
- For waste oil or chemical disposal
- With connection G2" for barrel of 60/200 l
- Diameter: 250 mm



BARREL FUNNEL

REF [107TA7237](#)

- Suitable for 200 l barrels
- Extra high capacity
- Supplied with hinged cover
- Outer diameter: 610 mm
- Height: 230 mm
- Weight: 4 kg
- Colour: yellow





BATTERY-POWERED GREASE GUN

REF 138TA8344

- Operates with grease up to NLGI grade 2
- Close-fitting plunger suitable for use of both bulk grease and cartridge
- Operating pressure: maximum 400 bar
- Battery quick-charge duration: 1 hour
- Continuous grease supply provided by 18 V electric motor

Containing:

- 18 V electric motor
- Flexible high-pressure hose: 11 x 1000 mm
- 1 coupler, 4 jaws
- 1 battery charger (230 V)
- 2 batteries NiCd 18 V
- Carrying strap



INDUSTRIAL GREASE GUN

REF 138TA6594

- Capacity: 500 cc M 10x1
- With 1 high-pressure hose: 11 x 300 mm
- With 1 angled spout, 2 precision machined hydraulic couplers, 4 jaws
- Operates with grease
- Sealing system: o-ring and ball valve prevent grease compressed in the grease gun head from feeding back
- Designed to be utilized under rough conditions with variable stroke system



GAS COCK GREASE



REF 107TA8492

- For gas taps and valves in combination with metal, glass and synthetic material
- 50 g



MAGNETIC RECHARGEABLE LED WARNING LIGHT



TOTAL SOURCE®

REF 141TA7068

- Height: 34 mm
- Diameter: 106,50 mm
- 9 different flashing patterns
- Shock-resistant
- Magnetic
- Water-resistant
- With universal charger

These lights can quickly and easily be deployed in case of:

- Works on and along the road
- Vehicle breakdown
- Loading and unloading of a vehicle
- Events

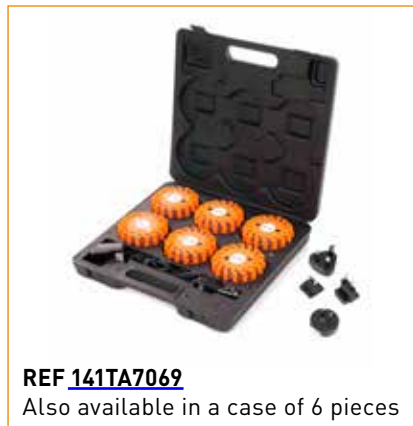

REF 141TA7069

Also available in a case of 6 pieces



AERIAL TOOL BIN

REF 141TA1508

- Ergonomic, triangular shaped design, weighs 4,5 kg
- Dimensions (L x H x W): 620 x 230 x 490 mm
- Holds up to 22 kg
- Made of reinforced, non-conductive, UV protected polypropylene orange plastic
- Light, durable ... and nearly as strong as steel
- Attaches to square or rounded 90 degree corners of a platform's railing
- 3 compartments with removable partition walls
- Multi-positional magnetic parts tray for holding small parts, attaches to the metal strips on top of the bin
- Tool belt holder safely secures a worker's tool belt to the front of the bin
- Built-in handle for easy carrying
- No more bending all-day-long searching for tools and parts. Everything is right at hand.
- More relief for your back – your tool belt attaches right to the front of the bin.





PROTECTIVE COVER



REF 106TA6807

Dimensions (L x W x H): 260 x 255 x 360 mm

REF 143TA5692

Dimensions (L x W x H): 900 x 320 x 360/250 mm



- For steering control unit of aerial work platforms
- PVC-coated cloth with polyester tissue
- Water-resistant
- Eyelets in messing

MULTIPURPOSE EXTREME-PRESSURE LITHIUM/CALCIUM GREASE - NLGI 2

REF 107TA7220 – 400 g

REF 141TA3233 – 18 kg

REF 140TA8781 – 50 kg

Product description:

- A multipurpose extreme-pressure grease, formulated for the lubrication of all kinds of industrial applications, operating in wet and dusty and/or dry conditions
- Also suitable as EP multipurpose grease, in "off-road" applications where water is in frequent contact with the grease, e.g. pin-bushings, Crown and Caterpillar wheels on excavators
- Always avoid contamination of the grease by dust and/or dirt when applying. Preferably use a pneumatic pump system or cartridges

Specifications:

- ISO 6743-9 L-XBDHB 2
- DIN 51 502 KP2K -25

Advantages:

- Because of its true multipurpose character it may replace a wide range of greases, allowing stock rationalization and simplification of maintenance
- Forms a durable lubrication film, resulting in reduction of maintenance and down-time costs
- Miscible with most other conventional soap greases
- Excellent mechanical stability avoiding ejection or loss of consistency during operation
- Excellent adhesion to metal
- Good thermal stability, leading to high resistance to temperature variations
- This grease does not contain lead, or other heavy metals considered harmful to human health and the environment



TOTALSOURCE®



HIGH STRENGTH THREADLOCKER

REF [143TA3468](#)

24 ml

REF [143TA8197](#)

50 ml

- High strength, low viscosity
- Max thread size: M80
- Service temperature range: -55 to 150 °C
- Strength: high
- Breakaway torque: 26 Nm
- Viscosity: 400–600 mPa·s
- Fixture time: 10 min

Loctite 271 is designed for the permanent locking and sealing of threaded fasteners. The product cures when confined in the absence of air between close fitting metal surfaces and prevents loosening and leakage from shock and vibration. Typical applications include the locking and sealing of large bolts and studs (up to M25).



LOCTITE

RETAINING COMPOUND

REF [143TA3500](#)

- High strength, general purpose
- Service temperature range: -55 to 150 °C
- Viscosity: 2000–3000 mPa·s
- Tensile shear strength: >25 N/mm²
- Fixture time: 4 min
- Max diametrical clearance: 0,25 mm
- P1 NSF
- 50 ml

Loctite 638:

- Best resistance to dynamic, axial and radial loads
- Ideal for shafts, gears, pulleys and similar cylindrical parts



LOCTITE



Consumables & accessories catalogue

REF 21713862



GROUND SUPPORT PLATES



Advantages:

- Extremely strong and flexible
- High wear-resistance
- Lightweight
- Easy to stack

Characteristics:

- Carrying capacity up to 50 tonne per plate
- Standard with 2 handles per plate (1 per short side)
- Made of 100% durable recycled synthetic material (UHMWPE)
- Standard with a smooth surface
- Technical sheet available on request
- Not suitable to span gaps or for machines with steel tracks

Length	Width	Thickness	Weight	REF
2000 mm	1000 mm	15 mm	30 kg	134TA8181
2000 mm	1000 mm	20 mm	40 kg	134TA8182
3000 mm	1000 mm	15 mm	45 kg	134TA8185
3000 mm	1000 mm	20 mm	60 kg	134TA8186



Applications

Horticulture

- Lawns
- Driveways & terraces
- Sports fields

Events

- Temporary sidewalks
- Car parkings
- Floors

Construction industry



Storage rack for ground support plates



- Available in 2 dimensions
- Convenient storage for multiple ground support plates
- For easy transport of your ground support plates (with forklift)

Length	Width	Stack height	REF
2000 mm	1000 mm	435 mm	138TA8304
3000 mm	1000 mm	435 mm	138TA8303

Connector for ground support plates



REF [127TA2465](#)

Suitable for ground support plates with a thickness of 15 mm

Extra options



Engraving of company name or logo (from 50 pieces onwards)