



MUFFLERS

For all our latest catalogue updates and company info: www.tvh.com

MUFFLERS

used for: **MITSUBISHI-CATERPILLAR**

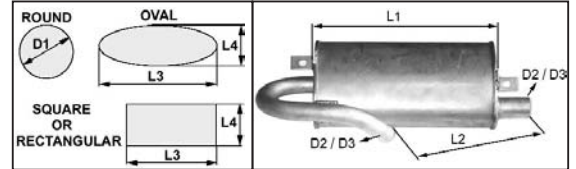

Type muffler	Length (mm) L1	Dimension (mm) L2	Body dimension (mm) dia. D1 or L3 x L4	Smallest outer dia. tube (mm) D2	Largest outer dia. tube (mm) D3	REF
Oval	285	240	265 X 140	45	49	139TA1558
Oval	330	450	245 X 135	42	42	139TA1559
Oval	350	155	214 X 122	38	42	134TA7774
Oval	350	430	193 X 102	38	42	134TA7674
Oval	351	455	191 X 103	37	41	124TA7177
Oval	355	470	210 X 130	50	56	123TA9891
Oval	380	218	200 X 105	32	45	134TA7652
Oval	395	570	200 X 110	42	47	139TA1560
Oval	450	450	190 X 110	50	55	108TA4312
Oval	470	975	230 X 116	63	90	139TA1561
Oval	495	250	255 X 150	51	51	105TA6723
Oval	505	610	244 X 150	60	65	134TA7681



REF [139TA1558](#)



REF [139TA1559](#)



REF [134TA7774](#)



REF [134TA7674](#)



REF [124TA7177](#)



REF [123TA9891](#)



REF [134TA7652](#)



REF [139TA1560](#)



REF [108TA4312](#)



REF [139TA1561](#)



REF [105TA6723](#)



REF [134TA7681](#)

MUFFLERS

For all our latest catalogue updates and company info: www.tvh.com



MUFFLERS

used for: **MITSUBISHI-CATERPILLAR**

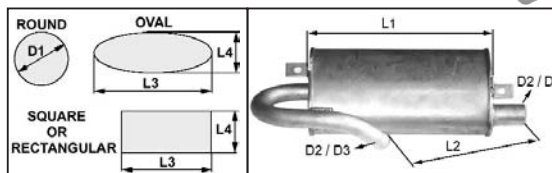

Type muffler	Length (mm) L1	Dimension (mm) L2	Body dimension (mm) dia. D1 or L3 x L4	Smallest outer dia. tube (mm) D2	Largest outer dia. tube (mm) D3	REF
Oval	507	78	215 X 120	51	55	110TA8571
Oval	510	80	210 X 120	50	55	104TA5838
Oval	510	250	245 X 150	50	50	104TA5851
Oval	510	610	244 X 149	50	50	123TA6009
Oval	510	670	230 X 105	51	51	134TA7989
Oval	515	31	238 X 130	51	54	118TA1357
Oval	515	495	305 X 220	105	106	139TA4621
Oval	515	617	211 X 123	45	49	139TA1562
Oval	515	735	182 X 95	39	42	139TA1563
Oval	520	730	210 X 125	45	48	139TA1564
Oval	670	580	210 X 120	50	55	105TA6678
Oval	670	590	215 X 120	50	56	108TA4317





MUFFLERS

For all our latest catalogue updates and company info: www.tvh.com

MUFFLERS

used for: **MITSUBISHI-CATERPILLAR**

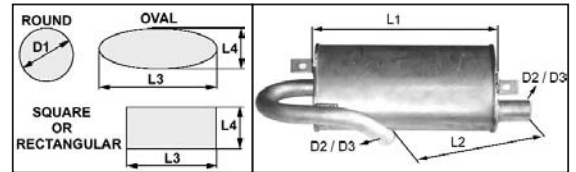

Type muffler	Length (mm) L1	Dimension (mm) L2	Body dimension (mm) dia. D1 or L3 x L4	Smallest outer dia. tube (mm) D2	Largest outer dia. tube (mm) D3	REF
Oval	680	330	216 X 118	51	53	134TA7727
Oval	685	742	210 X 120	51	54	124TA7178
Round	100	240	70	29	30	105TA6738
Round	110	875	65	38	42	123TA6011
Round	159	1040	101	39	45	139TA1565
Round	210	260	180	38	50	105TA6734
Round	220	1240	38	43	0	134TA7912
Round	230	250	170	38	54	105TA6672
Round	248	225	205	50	51	134TA7962
Round	250	200	183	41	45	110TA8541
Round	260	133	155	41	48	106TA5099
Round	285	515	190	43	43	105TA6765

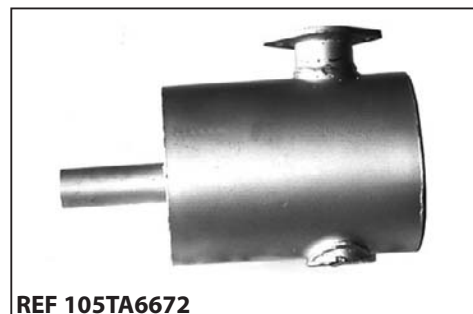

MUFFLERS

For all our latest catalogue updates and company info: www.tvh.com



MUFFLERS

used for: **mitsubishi-caterpillar**

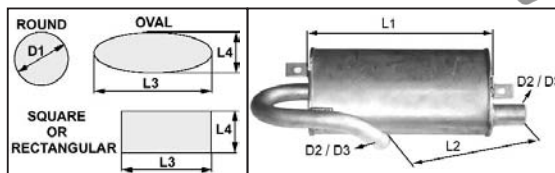

Type muffler	Length (mm) L1	Dimension (mm) L2	Body dimension (mm) dia. D1 or L3 x L4	Smallest outer dia. tube (mm) D2	Largest outer dia. tube (mm) D3	REF
Round	290	510	185	42	42	134TA7785
Round	290	640	167	38	47	139TA1566
Round	297	160	205	38	38	124TA1985
Round	298	635	205	38	42	134TA7953
Round	300	255	178	45	48	139TA1567
Round	300	270	175	45	49	139TA1568
Round	300	390	160	38	41	105TA6711
Round	300	400	165	35	38	139TA1569
Round	300	400	207	38	38	139TA1570
Round	300	405	200	38	38	134TA8139
Round	300	620	205	38	42	139TA1571
Round	300	730	210	38	42	134TA7771



REF [134TA7785](#)



REF [139TA1566](#)



REF [124TA1985](#)



REF [134TA7953](#)



REF [139TA1567](#)



REF [139TA1568](#)



REF [105TA6711](#)



REF [139TA1569](#)



REF [139TA1570](#)



REF [134TA8139](#)



REF [139TA1571](#)

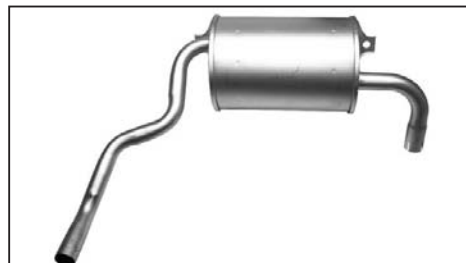

REF [134TA7771](#)



MUFFLERS

For all our latest catalogue updates and company info: www.tvh.com

MUFFLERS

used for: **mitsubishi-caterpillar**

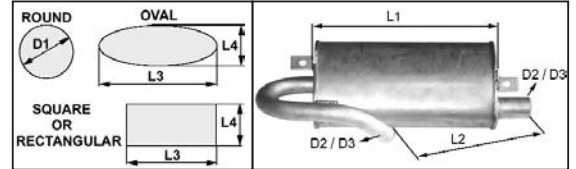

Type muffler	Length (mm) L1	Dimension (mm) L2	Body dimension (mm) dia. D1 or L3 x L4	Smallest outer dia. tube (mm) D2	Largest outer dia. tube (mm) D3	REF
Round	305	26	192	64	67	134TA7961
Round	305	636	145	32	42	110TA8556
Round	306	635	144	34	42	108TA4366
Round	307	640	145	33	42	123TA6013
Round	320	110	140	37	56	139TA4622
Round	320	340	155	38	45	139TA1572
Round	330	220	190	38	42	139TA1573
Round	340	250	170	38	43	134TA7624
Round	340	250	190	38	42	139TA4623
Round	340	305	170	38	46	139TA1574
Round	340	525	157	38	43	139TA4624
Round	340	570	170	38	42	134TA7639

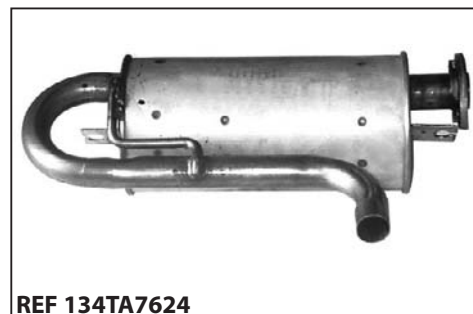

MUFFLERS



For all our latest catalogue updates and company info: www.tvh.com

MUFFLERS

used for: **mitsubishi-caterpillar**

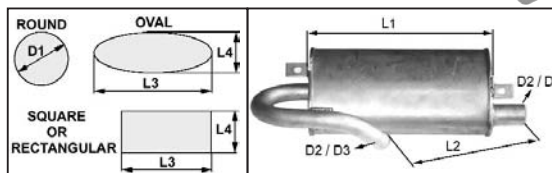

Type muffler	Length (mm) L1	Dimension (mm) L2	Body dimension (mm) dia. D1 or L3 x L4	Smallest outer dia. tube (mm) D2	Largest outer dia. tube (mm) D3	REF
Round	360	510	160	42	46	105TA6746
Round	370	203	230	63	68	134TA7671
Round	380	270	150	36	36	134TA7609
Round	392	342	181	41	51	108TA4293
Round	398	640	125	42	46	118TA1361
Round	407	23	143	41	49	108TA4353
Round	408	660	160	47	47	139TA1575
Round	410	500	145	44	49	134TA7631
Round	410	570	175	42	46	134TA7876
Round	415	640	168	47	47	134TA8147
Round	415	655	165	47	49	123TA6014
Round	415	830	170	42	47	134TA7883

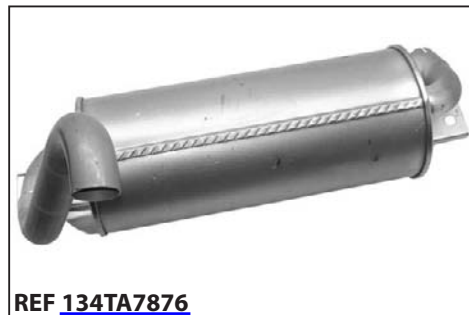



MUFFLERS

For all our latest catalogue updates and company info: www.tvh.com

MUFFLERS

used for: **MITSUBISHI-CATERPILLAR**

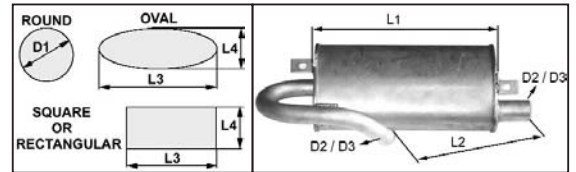

Type muffler	Length (mm) L1	Dimension (mm) L2	Body dimension (mm) dia. D1 or L3 x L4	Smallest outer dia. tube (mm) D2	Largest outer dia. tube (mm) D3	REF
Round	420	500	170	43	47	139TA1576
Round	450	1070	70	45	49	139TA1577
Round	455	580	179	70	73	118TA1363
Round	457	336	169	51	51	118TA1359
Round	460	430	155	39	47	105TA6686
Round	460	476	161	43	46	110TA8575
Round	460	550	160	38	42	134TA8051
Round	462	510	153	42	45	108TA4336
Round	480	620	160	43	48	139TA1578
Round	500	610	191	47	47	106TA6243
Round	500	610	215	65	65	134TA7834
Round	635	750	102	67	68	139TA1579

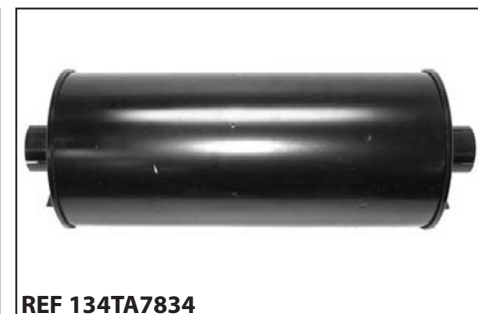
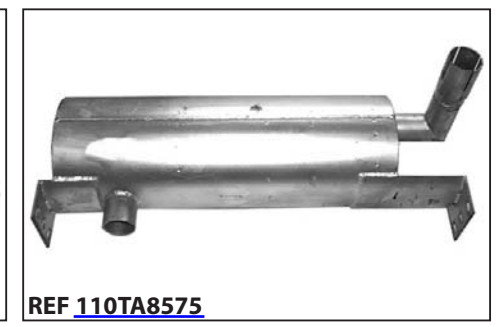

MUFFLERS

For all our latest catalogue updates and company info: www.tvh.com



MUFFLERS

used for: **mitsubishi-caterpillar**

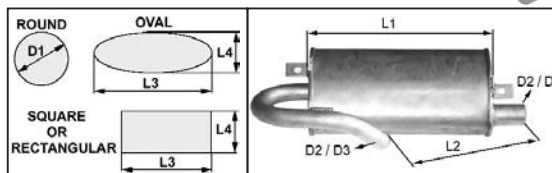

Type muffler	Length (mm) L1	Dimension (mm) L2	Body dimension (mm) dia. D1 or L3 x L4	Smallest outer dia. tube (mm) D2	Largest outer dia. tube (mm) D3	REF
Round	635	760	127	47	48	108TA4359
Round	645	1070	105	43	53	139TA1580
Round	730	1070	100	50	55	134TA7833
Round	740	1042	100	38	54	139TA1581
Round	777	1085	90	45	51	139TA1582
Round	865	1070	144	57	0	139TA1583
Round	880	1020	76	42	56	139TA1584
Round	920	1160	200	63	66	104TA5985
Round	1060	1260	127	51	54	108TA4345
Round	1073	1110	90	43	49	139TA1585
Round	1130	1293	145	62	67	108TA4339
Round	1135	1293	228	93	93	118TA1372

