

EXHAUST TUBES

For all our latest catalogue updates and company info: www.tvh.com



EXHAUST TUBES

used for: **MANITOU**

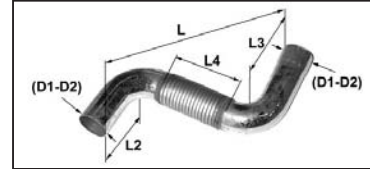

| Number of bends AT-BO | Smallest outer dia. tube (mm) D1 | Largest outer dia. tube (mm) D2 | Dimension (mm) L | Dimension (mm) L2 | Dimension (mm) L3 | Dimension (mm) L4 | REF |
|--------------------------|-------------------------------------|------------------------------------|---------------------|----------------------|----------------------|----------------------|---------------------------|
| 0 | 48 | 48 | 175 | | | | 118TA1669 |
| | 48 | 61 | 1055 | | | | 134TA6300 |
| | 55 | 55 | 176 | | | | 134TA6053 |
| | 59 | 59 | 232 | | | 147 | 108TA4445 |
| | 61 | 61 | 180 | | | 138 | 108TA4416 |
| 1 | 36 | 38 | 390 | 80 | 435 | 260 | 139TA4006 |
| | 42 | 42 | 125 | 50 | 75 | | 139TA4007 |
| | 43 | 47 | 127 | 25 | 90 | | 123TA6695 |
| | 45 | 49 | 100 | 20 | 75 | | 134TA6354 |
| | 50 | 56 | 124 | 50 | 110 | | 134TA6299 |
| | 55 | 60 | 115 | 35 | 90 | | 105TA6934 |
| | 56 | 56 | 305 | 20 | 285 | | 134TA5798 |

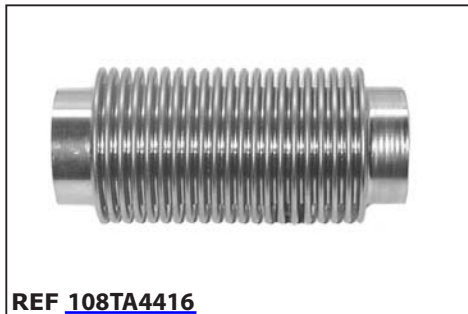

EXHAUST TUBES

For all our latest catalogue updates and company info: www.tvh.com

EXHAUST TUBES

used for: **MANITOU**

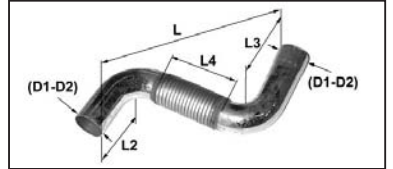

| Number of bends AT-BO | Smallest outer dia. tube (mm) D1 | Largest outer dia. tube (mm) D2 | Dimension (mm) L | Dimension (mm) L2 | Dimension (mm) L3 | Dimension (mm) L4 | REF |
|--------------------------|-------------------------------------|------------------------------------|---------------------|----------------------|----------------------|----------------------|---------------------------|
| 1 | 58 | 61 | 690 | 250 | 450 | | 139TA4008 |
| | 58 | 65 | 445 | 270 | 305 | 175 | 124TA7233 |
| | 60 | 64 | 105 | 25 | 80 | | 108TA4507 |
| | 60 | 77 | 245 | 130 | 210 | | 134TA5965 |
| | 61 | 64 | 323 | 90 | 305 | 170 | 134TA6007 |
| | 70 | 70 | 330 | 120 | 280 | 140 | 134TA6270 |
| | 70 | 76 | 220 | 120 | 150 | | 124TA7241 |
| | 76 | 90 | 335 | 30 | 310 | | 139TA4009 |
| 2 | 41 | 50 | 500 | 100 | 285 | | 108TA4539 |
| | 42 | 55 | 690 | 60 | 330 | | 134TA5797 |
| | 42 | 56 | 290 | 85 | 100 | | 134TA5799 |
| | 42 | 60 | 117 | 52 | 90 | | 108TA4538 |



EXHAUST TUBES

For all our latest catalogue updates and company info: www.tvh.com



EXHAUST TUBES

used for: **MANITOU**

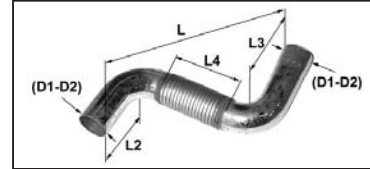

| Number of bends AT-BO | Smallest outer dia. tube (mm) D1 | Largest outer dia. tube (mm) D2 | Dimension (mm) L | Dimension (mm) L2 | Dimension (mm) L3 | Dimension (mm) L4 | REF |
|--------------------------|-------------------------------------|------------------------------------|---------------------|----------------------|----------------------|----------------------|---------------------------|
| 2 | 42 | 63 | 680 | 45 | 288 | 220 | 118TA1602 |
| | 43 | 61 | 352 | 25 | 82 | | 118TA1603 |
| | 45 | 48 | 375 | 30 | 250 | 50 | 139TA4010 |
| | 45 | 50 | 532 | 130 | 495 | | 139TA4011 |
| | 46 | 50 | 417 | 110 | 180 | | 118TA1521 |
| | 47 | 50 | 220 | 30 | 120 | | 134TA6214 |
| | 48 | 48 | 510 | 120 | 180 | | 134TA6056 |
| | 54 | 56 | 1170 | 20 | 60 | | 124TA7629 |
| | 54 | 60 | 475 | 95 | 100 | 150 | 134TA6067 |
| | 54 | 62 | 730 | 130 | 190 | 155 | 134TA6157 |
| | 55 | 60 | 480 | 80 | 95 | | 108TA4537 |
| | 56 | 60 | 370 | 65 | 70 | | 134TA5933 |



EXHAUST TUBES

For all our latest catalogue updates and company info: www.tvh.com

used for: **MANITOU**

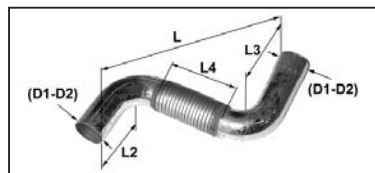

EXHAUST TUBES

| Number of bends AT-BO | Smallest outer dia. tube (mm) D1 | Largest outer dia. tube (mm) D2 | Dimension (mm) L | Dimension (mm) L2 | Dimension (mm) L3 | Dimension (mm) L4 | REF |
|--------------------------|-------------------------------------|------------------------------------|---------------------|----------------------|----------------------|----------------------|---------------------------|
| 2 | 56 | 65 | 933 | 110 | 650 | | 118TA1642 |
| | 60 | 60 | 350 | 110 | 120 | 70 | 139TA4012 |
| | 60 | 60 | 370 | 50 | 100 | 160 | 108TA4506 |
| | 60 | 61 | 205 | 55 | 115 | | 139TA4013 |
| | 60 | 62 | 270 | 20 | 90 | 150 | 139TA4014 |
| | 60 | 65 | 295 | 35 | 75 | 130 | 134TA6052 |
| | 64 | 64 | 450 | 110 | 120 | 168 | 123TA6696 |
| | 64 | 72 | 435 | 110 | 115 | 145 | 134TA6212 |
| 3 | 42 | 42 | 750 | 75 | 120 | 150 | 139TA4015 |
| | 42 | 50 | 435 | 50 | 95 | | 134TA5868 |
| | 54 | 64 | 760 | 30 | 125 | 115 | 134TA5790 |
| | 54 | 72 | 390 | 55 | 190 | 115 | 139TA4016 |



REF [118TA1642](#)



REF [139TA4012](#)



REF [108TA4506](#)



REF [139TA4013](#)



REF [139TA4014](#)



REF [134TA6052](#)



REF [123TA6696](#)



REF [134TA6212](#)

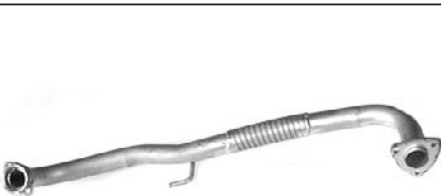

REF [139TA4015](#)



REF [134TA5868](#)



REF [134TA5790](#)



REF [139TA4016](#)

EXHAUST TUBES

For all our latest catalogue updates and company info: www.tvh.com



EXHAUST TUBES

used for: **MANITOU**

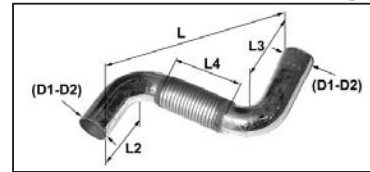

| Number of bends AT-BO | Smallest outer dia. tube (mm) D1 | Largest outer dia. tube (mm) D2 | Dimension (mm) L | Dimension (mm) L2 | Dimension (mm) L3 | Dimension (mm) L4 | REF |
|--------------------------|-------------------------------------|------------------------------------|---------------------|----------------------|----------------------|----------------------|---------------------------|
| 3 | 55 | 60 | 255 | 55 | 100 | | 108TA4415 |
| | 60 | 60 | 1080 | 20 | 130 | | 134TA6070 |
| | 60 | 60 | 1265 | 70 | 490 | | 139TA4017 |
| | 60 | 60 | 1770 | 30 | 120 | | 139TA4018 |
| | 60 | 64 | 815 | 60 | 245 | 160 | 139TA4019 |
| | 60 | 65 | 290 | 80 | 145 | | 134TA5945 |
| | 60 | 79 | 1775 | 30 | 125 | | 123TA6697 |
| | 64 | 72 | 350 | 200 | 250 | 160 | 124TA1082 |
| | 64 | 72 | 410 | 180 | 245 | 145 | 134TA6160 |
| | 64 | 72 | 520 | 100 | 245 | 140 | 123TA6698 |
| | 65 | 65 | 490 | 30 | 80 | 115 | 134TA5810 |
| 4 | 49 | 60 | 500 | 55 | 70 | 140 | 134TA6332 |

