

# MUFFLERS

For all our latest catalogue updates and company info: [www.tvh.com](http://www.tvh.com)



MUFFLERS

used for: **KOMATSU**

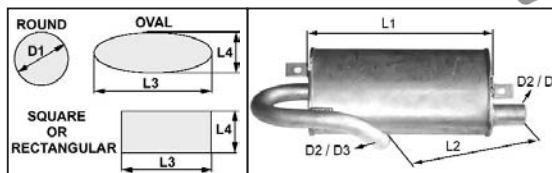

Type muffler	Length (mm) L1	Dimension (mm) L2	Body dimension (mm) dia. D1 or L3 x L4	Smallest outer dia. tube (mm) D2	Largest outer dia. tube (mm) D3	REF
Oval	270	450	120 X 90	40	40	<a href="#">118TA1203</a>
Oval	282	15	244 X 137	38	48	<a href="#">139TA4613</a>
Oval	350	370	210 X 140	38	38	<a href="#">104TA5967</a>
Oval	350	380	215 X 135	38	38	<a href="#">134TA8099</a>
Oval	350	380	220 X 140	38	38	<a href="#">104TA5910</a>
Oval	350	380	220 X 140	38	38	<a href="#">123TA6039</a>
Oval	350	425	312 X 170	50	55	<a href="#">134TA7971</a>
Oval	350	497	218 X 138	38	42	<a href="#">134TA8076</a>
Oval	350	705	220 X 140	38	42	<a href="#">134TA8068</a>
Oval	350	720	220 X 140	38	41	<a href="#">134TA7913</a>
Oval	400	512	204 X 104	35	45	<a href="#">118TA1251</a>
Oval	405	680	170 X 90	52	52	<a href="#">134TA7775</a>

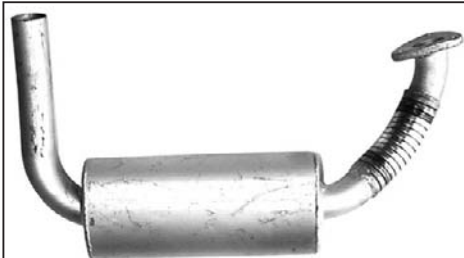

REF [118TA1203](#)



REF [139TA4613](#)



REF [104TA5967](#)



REF [134TA8099](#)

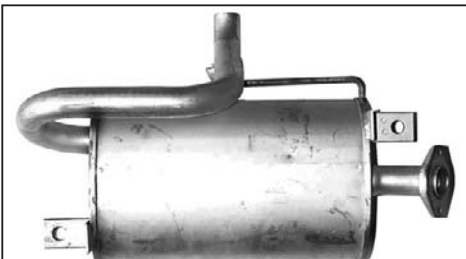

REF [104TA5910](#)



REF [123TA6039](#)



REF [134TA7971](#)



REF [134TA8076](#)



REF [134TA8068](#)



REF [134TA7913](#)



REF [118TA1251](#)



REF [134TA7775](#)



# MUFFLERS

For all our latest catalogue updates and company info: [www.tvh.com](http://www.tvh.com)

MUFFLERS

used for: **KOMATSU**

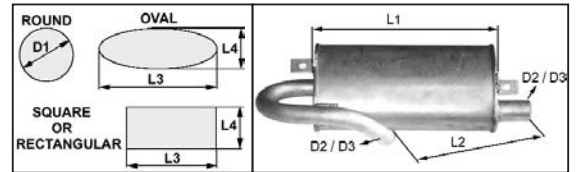

Type muffler	Length (mm) L1	Dimension (mm) L2	Body dimension (mm) dia. D1 or L3 x L4	Smallest outer dia. tube (mm) D2	Largest outer dia. tube (mm) D3	REF
Oval	450	880	177 X 100	42	47	<a href="#">118TA1271</a>
Oval	480	710	227 X 121	50	55	<a href="#">123TA9883</a>
Oval	480	710	228 X 118	50	55	<a href="#">118TA1256</a>
Oval	500	717	187 X 99	45	50	<a href="#">118TA1317</a>
Oval	500	750	190 X 100	45	49	<a href="#">118TA1202</a>
Oval	560	135	204 X 105	41	51	<a href="#">108TA4319</a>
Oval	560	350	200 X 100	41	48	<a href="#">134TA7670</a>
Oval	577	490	177 X 102	42	55	<a href="#">134TA7685</a>
Oval	624	618	204 X 104	57	64	<a href="#">134TA7700</a>
Round	265	30	178	54	54	<a href="#">139TA4614</a>
Round	270	280	150	35	39	<a href="#">105TA6719</a>
Round	270	410	150	34	38	<a href="#">105TA6720</a>

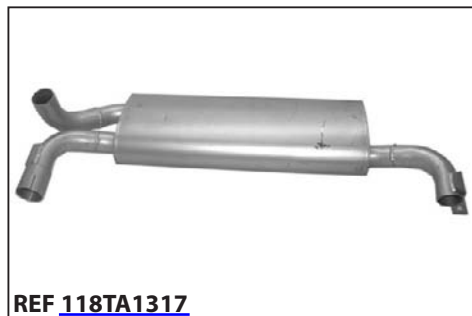
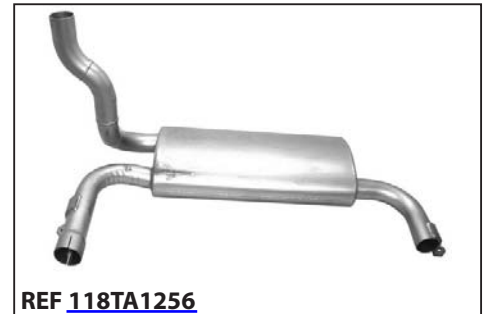
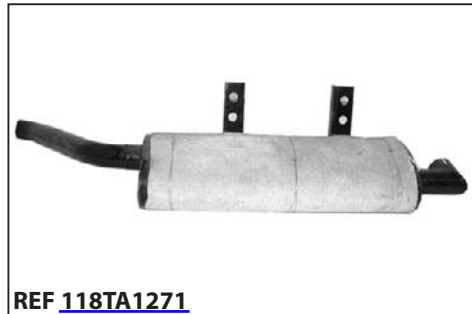

# MUFFLERS

For all our latest catalogue updates and company info: [www.tvh.com](http://www.tvh.com)



MUFFLERS

used for: **KOMATSU**

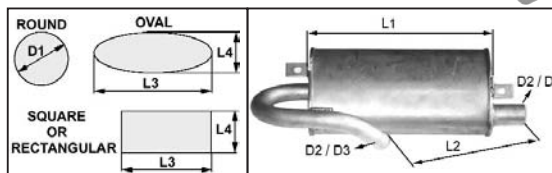

Type muffler	Length (mm) L1	Dimension (mm) L2	Body dimension (mm) dia. D1 or L3 x L4	Smallest outer dia. tube (mm) D2	Largest outer dia. tube (mm) D3	REF
Round	290	370	175	38	47	<a href="#">134TA8066</a>
Round	290	415	175	38	47	<a href="#">134TA8067</a>
Round	290	640	167	38	47	<a href="#">104TA5801</a>
Round	290	700	175	38	47	<a href="#">105TA6774</a>
Round	290	705	175	38	47	<a href="#">139TA4615</a>
Round	292	550	169	35	46	<a href="#">105TA6752</a>
Round	295	280	210	38	40	<a href="#">134TA7894</a>
Round	295	285	180	38	47	<a href="#">118TA1343</a>
Round	295	580	182	38	38	<a href="#">134TA8096</a>
Round	295	670	180	38	45	<a href="#">106TA5003</a>
Round	297	345	201	34	42	<a href="#">108TA8867</a>
Round	300	270	175	45	49	<a href="#">124TA1127</a>





# MUFFLERS

For all our latest catalogue updates and company info: [www.tvh.com](http://www.tvh.com)

MUFFLERS

used for: **KOMATSU**

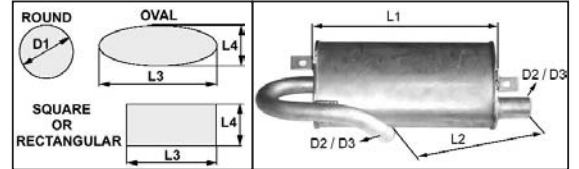

Type muffler	Length (mm) L1	Dimension (mm) L2	Body dimension (mm) dia. D1 or L3 x L4	Smallest outer dia. tube (mm) D2	Largest outer dia. tube (mm) D3	REF
Round	300	320	168	38	38	<a href="#">139TA1537</a>
Round	300	410	169	38	38	<a href="#">139TA1538</a>
Round	300	430	180	45	49	<a href="#">106TA7339</a>
Round	300	490	170	35	46	<a href="#">104TA5734</a>
Round	300	500	190	34	47	<a href="#">104TA5927</a>
Round	300	565	175	35	45	<a href="#">139TA4616</a>
Round	300	580	170	35	47	<a href="#">134TA7597</a>
Round	300	600	173	35	46	<a href="#">105TA6826</a>
Round	300	650	190	35	47	<a href="#">105TA6721</a>
Round	300	685	180	38	38	<a href="#">134TA7851</a>
Round	300	690	177	39	39	<a href="#">118TA1259</a>
Round	320	110	140	37	56	<a href="#">139TA4617</a>



REF [139TA1537](#)



REF [139TA1538](#)



REF [106TA7339](#)



REF [104TA5734](#)



REF [104TA5927](#)



REF [139TA4616](#)



REF [134TA7597](#)



REF [105TA6826](#)



REF [105TA6721](#)



REF [134TA7851](#)



REF [118TA1259](#)



REF [139TA4617](#)

# MUFFLERS

For all our latest catalogue updates and company info: [www.tvh.com](http://www.tvh.com)



MUFFLERS

used for: **KOMATSU**

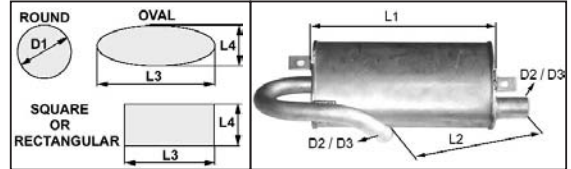

Type muffler	Length (mm) L1	Dimension (mm) L2	Body dimension (mm) dia. D1 or L3 x L4	Smallest outer dia. tube (mm) D2	Largest outer dia. tube (mm) D3	REF
Round	320	340	155	38	45	<a href="#">123TA6040</a>
Round	320	343	152	39	46	<a href="#">108TA4321</a>
Round	320	345	152	39	46	<a href="#">134TA7672</a>
Round	330	320	140	34	37	<a href="#">105TA6691</a>
Round	330	490	133	48	50	<a href="#">134TA7673</a>
Round	340	210	160	43	46	<a href="#">105TA6712</a>
Round	345	340	160	34	37	<a href="#">105TA6736</a>
Round	350	290	150	51	51	<a href="#">108TA4308</a>
Round	350	385	200	51	56	<a href="#">118TA1351</a>
Round	385	715	121	51	67	<a href="#">134TA7817</a>
Round	395	635	166	51	51	<a href="#">134TA7893</a>
Round	400	640	175	48	51	<a href="#">104TA5994</a>

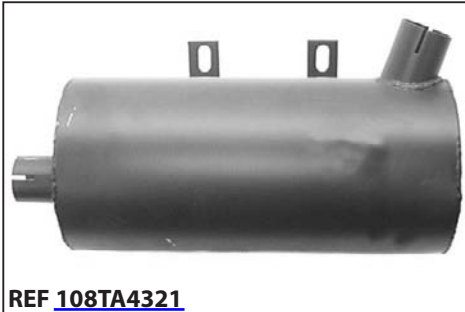



# MUFFLERS

For all our latest catalogue updates and company info: [www.tvh.com](http://www.tvh.com)

MUFFLERS

used for: **KOMATSU**

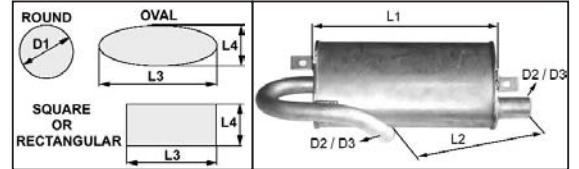

Type muffler TY	Length (mm) L1	Dimension (mm) L2	Body dimension (mm) dia. D1 or L3 x L4	Smallest outer dia. tube (mm) D2	Largest outer dia. tube (mm) D3	REF
Round	400	655	170	48	51	<a href="#">124TA5194</a>
Round	400	720	180	48	51	<a href="#">104TA5897</a>
Round	401	267	151	43	45	<a href="#">110TA8555</a>
Round	403	330	220	73	75	<a href="#">123TA6041</a>
Round	418	645	204	52	55	<a href="#">134TA7965</a>
Round	420	590	190	51	55	<a href="#">134TA7903</a>
Round	420	640	175	51	54	<a href="#">105TA6777</a>
Round	420	660	180	49	51	<a href="#">104TA5758</a>
Round	420	670	190	51	55	<a href="#">123TA6042</a>
Round	423	372	216	53	60	<a href="#">118TA1316</a>
Round	423	645	172	48	51	<a href="#">118TA1355</a>
Round	427	710	202	51	56	<a href="#">108TA4287</a>

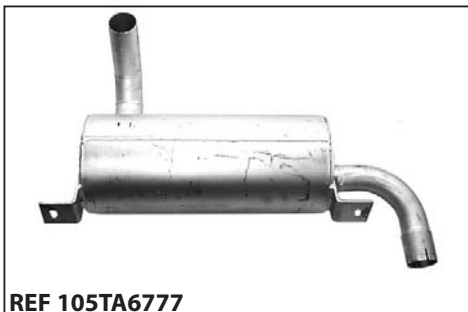

# MUFFLERS

For all our latest catalogue updates and company info: [www.tvh.com](http://www.tvh.com)



MUFFLERS

used for: **KOMATSU**

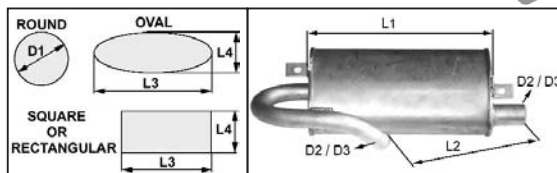

Type muffler	Length (mm) L1	Dimension (mm) L2	Body dimension (mm) dia. D1 or L3 x L4	Smallest outer dia. tube (mm) D2	Largest outer dia. tube (mm) D3	REF
Round	440	290	100	34	38	<a href="#">118TA1197</a>
Round	450	250	143	35	38	<a href="#">134TA7721</a>
Round	450	540	144	42	46	<a href="#">108TA8875</a>
Round	450	545	152	42	47	<a href="#">108TA4354</a>
Round	470	285	100	38	39	<a href="#">118TA1255</a>
Round	470	460	110	38	38	<a href="#">139TA1539</a>
Round	500	885	220	76	93	<a href="#">139TA1540</a>
Round	500	920	220	51	55	<a href="#">134TA7835</a>
Round	505	610	130	46	49	<a href="#">118TA1206</a>
Round	510	530	139	49	51	<a href="#">124TA5199</a>
Round	548	685	152	50	56	<a href="#">118TA1233</a>
Round	580	550	150	63	63	<a href="#">105TA6747</a>





# MUFFLERS

For all our latest catalogue updates and company info: [www.tvh.com](http://www.tvh.com)

MUFFLERS

used for: **KOMATSU**

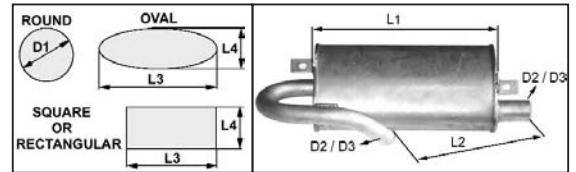

Type muffler	Length (mm) L1	Dimension (mm) L2	Body dimension (mm) dia. D1 or L3 x L4	Smallest outer dia. tube (mm) D2	Largest outer dia. tube (mm) D3	REF
Round	605	700	153	50	55	<a href="#">134TA8143</a>
Round	615	718	156	54	60	<a href="#">134TA7733</a>
Round	615	745	101	63	66	<a href="#">108TA4318</a>
Round	620	750	121	63	66	<a href="#">108TA4322</a>
Round	635	130	144	57	58	<a href="#">134TA7699</a>
Round	635	1040	102	48	48	<a href="#">134TA7747</a>
Round	637	610	140	54	70	<a href="#">134TA7745</a>
Round	645	1070	105	43	53	<a href="#">118TA1366</a>
Round	650	100	150	50	54	<a href="#">118TA1201</a>
Round	705	345	180	57	57	<a href="#">139TA1541</a>
Round	710	415	180	57	57	<a href="#">134TA7882</a>
Round	710	830	162	42	62	<a href="#">134TA7815</a>





# MUFFLERS

For all our latest catalogue updates and company info: [www.tvh.com](http://www.tvh.com)



MUFFLERS

used for: **KOMATSU**

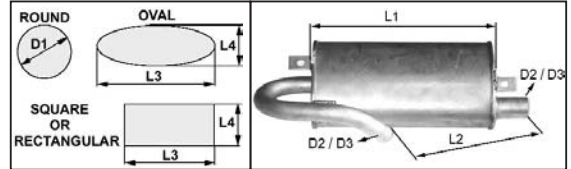

Type muffer	Length (mm) L1	Dimension (mm) L2	Body dimension (mm) dia. D1 or L3 x L4	Smallest outer dia. tube (mm) D2	Largest outer dia. tube (mm) D3	REF
Round	763	980	121	45	60	<a href="#">111TA1889</a>
Round	770	940	154	44	61	<a href="#">134TA7694</a>
Round	795	1080	80	50	54	<a href="#">118TA1240</a>
Round	802	1090	80	45	50	<a href="#">118TA1223</a>
Round	860	1070	140	60	0	<a href="#">108TA4307</a>
Round	863	1080	160	58	0	<a href="#">110TA8552</a>
Rectangular	500	1045	112 X 112	41	46	<a href="#">139TA1542</a>

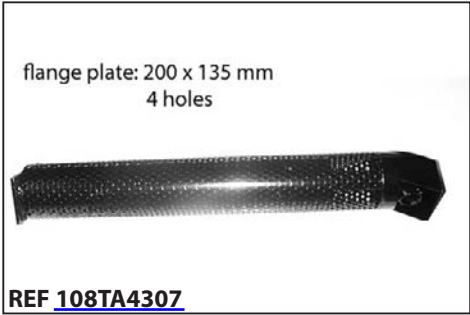

Look up these parts via