

# MUFFLERS

For all our latest catalogue updates and company info: [www.tvh.com](http://www.tvh.com)



MUFFLERS

used for: **JUNGHEINRICH-STEINBOCK**

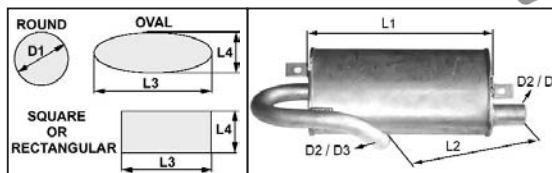

Type muffler	Length (mm) L1	Dimension (mm) L2	Body dimension (mm) dia. D1 or L3 x L4	Smallest outer dia. tube (mm) D2	Largest outer dia. tube (mm) D3	REF
Oval	285	240	265 X 140	45	49	<a href="#">134TA8084</a>
Oval	294	820	145 X 93	50	52	<a href="#">139TA4608</a>
Oval	296	685	138 X 85	52	52	<a href="#">118TA1342</a>
Oval	350	238	139 X 85	35	38	<a href="#">123TA6033</a>
Oval	380	218	200 X 105	32	45	<a href="#">134TA7651</a>
Oval	380	570	250 X 130	45	45	<a href="#">123TA6034</a>
Oval	385	645	250 X 135	48	45	<a href="#">108TA4349</a>
Oval	405	680	170 X 90	52	52	<a href="#">124TA5191</a>
Oval	515	617	211 X 123	45	49	<a href="#">139TA1527</a>
Oval	515	735	182 X 95	39	42	<a href="#">139TA1528</a>
Oval	520	730	210 X 125	45	48	<a href="#">134TA8105</a>
Oval	560	135	204 X 105	41	51	<a href="#">105TA6811</a>

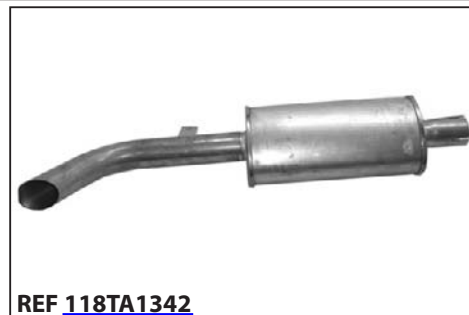



# MUFFLERS

For all our latest catalogue updates and company info: [www.tvh.com](http://www.tvh.com)

MUFFLERS

used for: **JUNGHEINRICH-STEINBOCK**

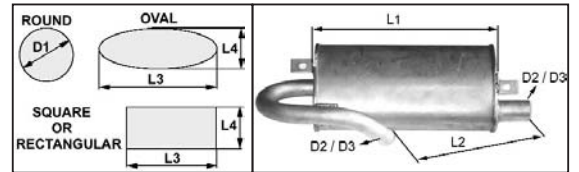

Type muffler	Length (mm) L1	Dimension (mm) L2	Body dimension (mm) dia. D1 or L3 x L4	Smallest outer dia. tube (mm) D2	Largest outer dia. tube (mm) D3	REF
Oval	560	350	200 X 100	41	48	<a href="#">118TA1224</a>
Oval	577	490	177 X 102	42	55	<a href="#">105TA6843</a>
Oval	624	618	204 X 104	57	64	<a href="#">108TA4298</a>
Round	158	1020	101	38	45	<a href="#">106TA7341</a>
Round	159	1040	101	39	45	<a href="#">106TA7336</a>
Round	160	765	101	38	38	<a href="#">108TA4335</a>
Round	160	780	100	35	38	<a href="#">105TA6683</a>
Round	160	1010	100	39	45	<a href="#">106TA7314</a>
Round	160	1030	100	39	46	<a href="#">106TA7313</a>
Round	160	1050	102	38	45	<a href="#">123TA6037</a>
Round	250	25	205	54	54	<a href="#">134TA8083</a>
Round	290	480	160	50	50	<a href="#">105TA6759</a>



REF [118TA1224](#)



REF [105TA6843](#)



REF [108TA4298](#)



REF [106TA7341](#)



REF [106TA7336](#)



REF [108TA4335](#)



REF [105TA6683](#)



REF [106TA7314](#)



REF [106TA7313](#)



REF [123TA6037](#)



REF [134TA8083](#)



REF [105TA6759](#)

# MUFFLERS

For all our latest catalogue updates and company info: [www.tvh.com](http://www.tvh.com)



MUFFLERS

used for: **JUNGHEINRICH-STEINBOCK**

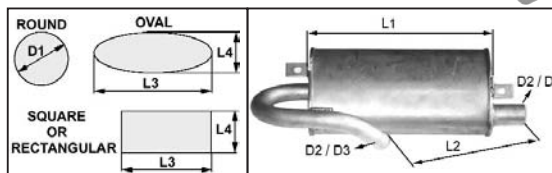

Type muffler	Length (mm) L1	Dimension (mm) L2	Body dimension (mm) dia. D1 or L3 x L4	Smallest outer dia. tube (mm) D2	Largest outer dia. tube (mm) D3	REF
Round	295	285	180	38	47	<a href="#">118TA1344</a>
Round	300	255	178	45	48	<a href="#">134TA7958</a>
Round	300	270	175	45	49	<a href="#">123TA9889</a>
Round	300	400	165	35	38	<a href="#">106TA7309</a>
Round	300	400	170	35	38	<a href="#">105TA6742</a>
Round	300	405	160	35	39	<a href="#">134TA8009</a>
Round	300	430	180	45	49	<a href="#">105TA6842</a>
Round	320	340	155	38	45	<a href="#">118TA1187</a>
Round	320	343	152	39	46	<a href="#">118TA1231</a>
Round	320	345	152	39	46	<a href="#">106TA7337</a>
Round	330	450	135	51	51	<a href="#">134TA7792</a>
Round	330	490	133	48	50	<a href="#">118TA1228</a>

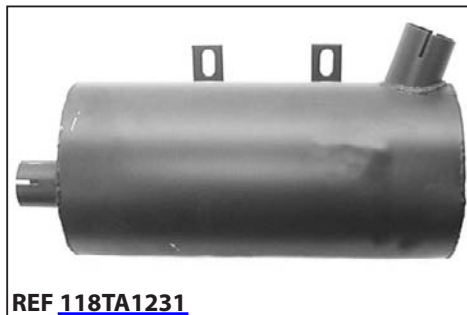



# MUFFLERS

For all our latest catalogue updates and company info: [www.tvh.com](http://www.tvh.com)

MUFFLERS

used for: **JUNGHEINRICH-STEINBOCK**

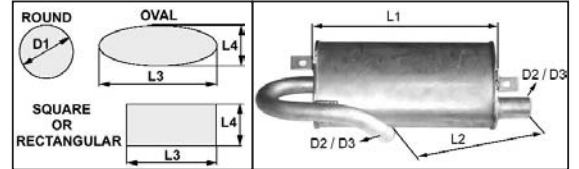

Type muffler	Length (mm) L1	Dimension (mm) L2	Body dimension (mm) dia. D1 or L3 x L4	Smallest outer dia. tube (mm) D2	Largest outer dia. tube (mm) D3	REF
Round	350	290	150	51	51	<a href="#">118TA1216</a>
Round	355	342	91	44	50	<a href="#">108TA4338</a>
Round	380	120	185	42	42	<a href="#">108TA4310</a>
Round	380	195	190	42	42	<a href="#">105TA6704</a>
Round	385	715	121	51	67	<a href="#">134TA7818</a>
Round	400	540	160	45	45	<a href="#">105TA6754</a>
Round	400	600	208	44	54	<a href="#">106TA4996</a>
Round	430	570	150	35	38	<a href="#">105TA6751</a>
Round	450	1070	70	45	49	<a href="#">134TA8109</a>
Round	500	670	210	48	52	<a href="#">134TA7875</a>
Round	510	730	84	45	51	<a href="#">111TA3672</a>
Round	610	700	158	54	61	<a href="#">134TA8124</a>

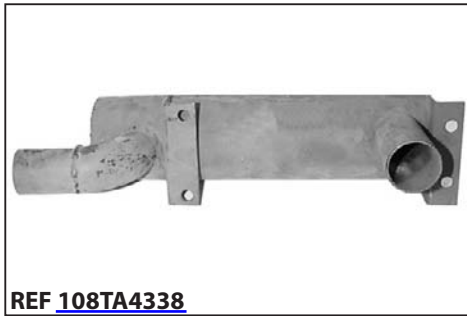

# MUFFLERS



For all our latest catalogue updates and company info: [www.tvh.com](http://www.tvh.com)

used for: **JUNGHEINRICH-STEINBOCK**

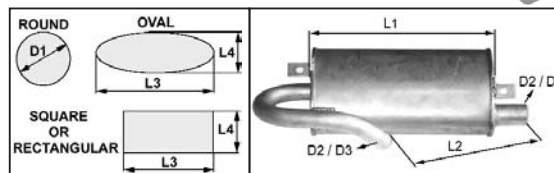

MUFFLERS

Type muffler	Length (mm) L1	Dimension (mm) L2	Body dimension (mm) dia. D1 or L3 x L4	Smallest outer dia. tube (mm) D2	Largest outer dia. tube (mm) D3	REF
Round	612	825	144	51	54	<a href="#">118TA1294</a>
Round	615	718	156	54	60	<a href="#">110TA9634</a>
Round	615	745	101	63	66	<a href="#">105TA6797</a>
Round	620	750	121	63	66	<a href="#">118TA1238</a>
Round	630	680	178	54	60	<a href="#">134TA8120</a>
Round	635	130	144	57	58	<a href="#">108TA4300</a>
Round	635	710	147	53	53	<a href="#">124TA1991</a>
Round	635	750	102	67	68	<a href="#">108TA8866</a>
Round	635	1040	102	48	48	<a href="#">118TA1328</a>
Round	637	610	140	54	70	<a href="#">118TA1322</a>
Round	637	670	143	49	60	<a href="#">108TA4360</a>
Round	640	650	145	53	61	<a href="#">118TA1320</a>



REF [118TA1294](#)

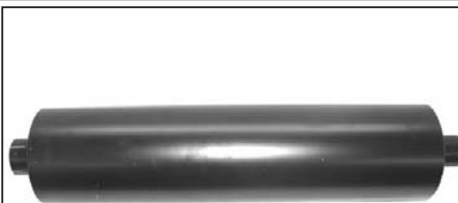

REF [110TA9634](#)

flange plate: 200 x 135 mm  
4 holes



REF [105TA6797](#)



REF [118TA1238](#)



REF [134TA8120](#)



REF [108TA4300](#)



REF [124TA1991](#)



REF [108TA8866](#)

flange plate: 200 x 170 mm  
4 holes Ø 14 mm



REF [118TA1328](#)



REF [118TA1322](#)



REF [108TA4360](#)



REF [118TA1320](#)



# MUFFLERS

For all our latest catalogue updates and company info: [www.tvh.com](http://www.tvh.com)

MUFFLERS

used for: **JUNGHEINRICH-STEINBOCK**

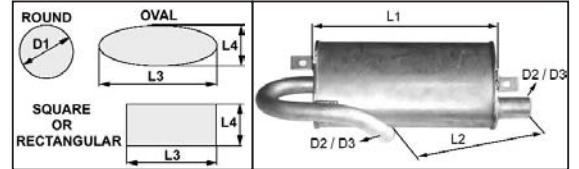

Type muffler	Length (mm) L1	Dimension (mm) L2	Body dimension (mm) dia. D1 or L3 x L4	Smallest outer dia. tube (mm) D2	Largest outer dia. tube (mm) D3	REF
Round	645	1070	105	43	53	<a href="#">118TA1367</a>
Round	675	800	252	78	81	<a href="#">134TA7658</a>
Round	705	345	180	57	57	<a href="#">139TA1529</a>
Round	710	415	180	57	57	<a href="#">139TA1530</a>
Round	710	830	162	42	62	<a href="#">134TA7816</a>
Round	740	1042	100	38	54	<a href="#">105TA6791</a>
Round	750	1070	100	44	54	<a href="#">134TA7826</a>
Round	763	980	121	45	60	<a href="#">111TA1890</a>
Round	768	920	132	45	54	<a href="#">105TA6664</a>
Round	770	940	154	44	61	<a href="#">106TA5000</a>
Round	777	1085	90	45	51	<a href="#">134TA8131</a>
Round	860	1070	140	60	0	<a href="#">105TA6673</a>

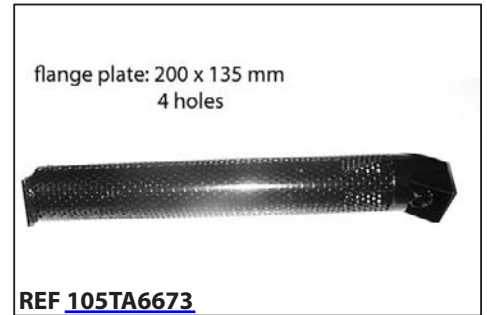

# MUFFLERS



For all our latest catalogue updates and company info: [www.tvh.com](http://www.tvh.com)

used for: **JUNGHEINRICH-STEINBOCK**

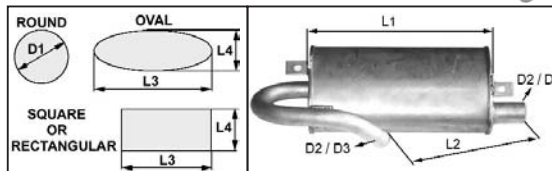

MUFFLERS

Type muffler	Length (mm) L1	Dimension (mm) L2	Body dimension (mm) dia. D1 or L3 x L4	Smallest outer dia. tube (mm) D2	Largest outer dia. tube (mm) D3	REF
Round	863	1080	160	58	0	<a href="#">110TA8553</a>
Round	865	1070	144	57	0	<a href="#">111TA1898</a>
Round	880	1020	76	42	56	<a href="#">105TA6864</a>
Round	900	1050	80	42	52	<a href="#">139TA1532</a>
Round	905	1070	75	44	52	<a href="#">118TA1249</a>
Round	915	1015	228	102	102	<a href="#">134TA7942</a>
Round	953	947	285	101	103	<a href="#">123TA6036</a>
Round	1000	1070	95	61	63	<a href="#">106TA5002</a>
Round	1073	1110	90	43	49	<a href="#">106TA7342</a>

