

EXHAUST TUBES

For all our latest catalogue updates and company info: www.tvh.com

EXHAUST TUBES

used for: **ALLIS CHALMERS-KALMAR AC**

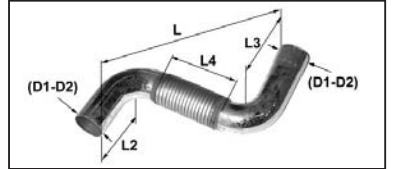

Number of bends AT-BO	Smallest outer dia. tube (mm) D1	Largest outer dia. tube (mm) D2	Dimension (mm) L	Dimension (mm) L2	Dimension (mm) L3	Dimension (mm) L4	REF
0	53	53	190				123TA6559
	58	58	110				123TA6560
1	42	42	328	75	255	140	123TA6561
	60	60	225	80	150		134TA6004
2	41	48	420	80	85	140	123TA6562
	42	47	370	60	70	210	134TA6078
	45	50	800	120	265	110	123TA6563
3	34	34	575	80	175		123TA6564
	34	35	400	80	290	110	123TA6565
	37	40	565	37	75	150	123TA6566
	43	43	425	80	90	140	108TA8882
	50	80	885	110	210	100	134TA6337



EXHAUST TUBES

For all our latest catalogue updates and company info: www.tvh.com



EXHAUST TUBES

used for: **ALLIS CHALMERS-KALMAR AC**

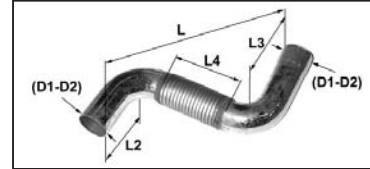

Number of bends AT-BO	Smallest outer dia. tube (mm) D1	Largest outer dia. tube (mm) D2	Dimension (mm) L	Dimension (mm) L2	Dimension (mm) L3	Dimension (mm) L4	REF
3	51	54	883	110	125	110	123TA6567
4	34	43	575	15	105	155	123TA6568
	35	42	280	65	125	150	139TA3800
	38	41	595	70	170	145	123TA6569
	42	42	550	20	80		134TA5847
	44	51	740	55	177	170	123TA6570
	45	51	890	43	135	430	123TA6571
	48	51	720	35	276		123TA6572
	50	50	1010	30	200	240	134TA5895
	51	51	920	70	170	150	123TA6573
	51	53	870	85	95	130	123TA6574
5	34	34	625	60	220		123TA6575

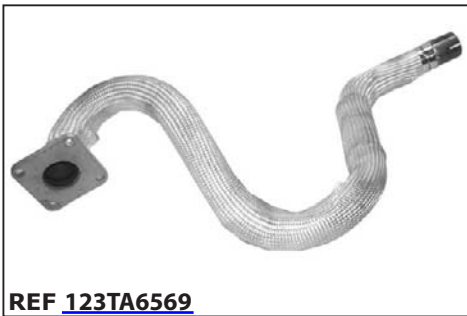

EXHAUST TUBES

For all our latest catalogue updates and company info: www.tvh.com

EXHAUST TUBES

used for: **ALLIS CHALMERS-KALMAR AC**

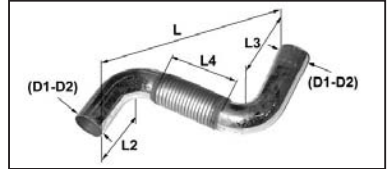

Number of bends AT-BO	Smallest outer dia. tube (mm) D1	Largest outer dia. tube (mm) D2	Dimension (mm) L	Dimension (mm) L2	Dimension (mm) L3	Dimension (mm) L4	REF
5	34	43	540	115	280	115	134TA5716
	38	38	135	7	54		134TA5765
	43	43	645	20	235		123TA6576



Look up these parts via

EXHAUST TUBES

For all our latest catalogue updates and company info: www.tvh.com



EXHAUST TUBES

used for: **ARTISON**

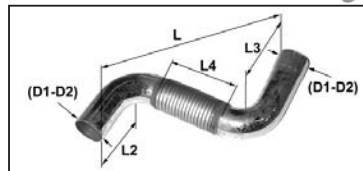

Number of bends AT-BO	Smallest outer dia. tube (mm) D1	Largest outer dia. tube (mm) D2	Dimension (mm) L	Dimension (mm) L2	Dimension (mm) L3	Dimension (mm) L4	REF
1	42	45	640	405	505	135	139TA3801
3	42	47	587	80	420	150	139TA3802
4	40	42	750	45	120	140	134TA5913
	41	42	410	35	75	135	134TA5917
	42	42	720	40	165	140	134TA5813
	42	57	730	125	130	170	134TA5658
	48	54	613	30	100	145	139TA3803
5	41	42	590	70	120	135	134TA5905
	42	42	550	50	125	130	134TA5909





EXHAUST TUBES

For all our latest catalogue updates and company info: www.tvh.com

used for: **ATLET-LAFIS**

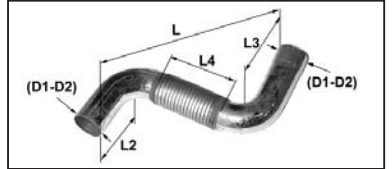

EXHAUST TUBES

Number of bends AT-BO	Smallest outer dia. tube (mm) D1	Largest outer dia. tube (mm) D2	Dimension (mm) L	Dimension (mm) L2	Dimension (mm) L3	Dimension (mm) L4	REF
0	48	48	705			560	139TA3804



REF [139TA3804](#)

EXHAUST TUBES

For all our latest catalogue updates and company info: www.tvh.com



EXHAUST TUBES

used for: **AUSA**

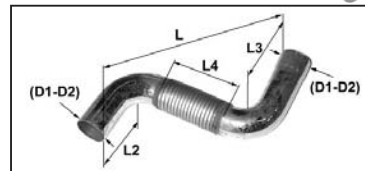

Number of bends	Smallest outer dia. tube (mm) D1	Largest outer dia. tube (mm) D2	Dimension (mm) L	Dimension (mm) L2	Dimension (mm) L3	Dimension (mm) L4	REF
0	33	48	320			185	134TA6100
	78	81	131				134TA6224
1	40	45	320	90	310	240	134TA6177
	40	50	290	130	235	150	134TA6225
	40	54	327	150	265	150	134TA6106
2	46	50	310	60	360	140	134TA6255
	48	54	315	25	325	120	134TA6097



EXHAUST TUBES

For all our latest catalogue updates and company info: www.tvh.com

used for: **BALKANCAR**

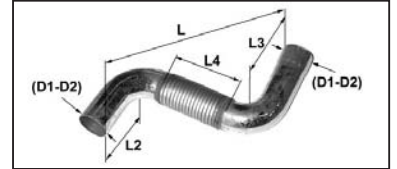

EXHAUST TUBES

Number of bends AT-BO	Smallest outer dia. tube (mm) D1	Largest outer dia. tube (mm) D2	Dimension (mm) L	Dimension (mm) L2	Dimension (mm) L3	Dimension (mm) L4	REF
2	50	60	640	175	345	245	134TA5751
	51	51	600	40	350	230	123TA6577
3	42	51	530	15	150	140	123TA6578
	50	50	685	100	195	135	123TA6579



EXHAUST TUBES

For all our latest catalogue updates and company info: www.tvh.com



EXHAUST TUBES

used for: **BAOLI**

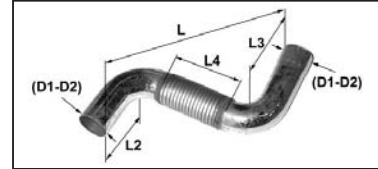

Number of bends AT-BO	Smallest outer dia. tube (mm) D1	Largest outer dia. tube (mm) D2	Dimension (mm) L	Dimension (mm) L2	Dimension (mm) L3	Dimension (mm) L4	REF
1	41	46	1135	195	1040		139TA3805
	54	57	245	83	185		139TA3806
2	38	47	530	105	300	135	139TA3807
4	38	38	670	90	105	140	139TA3808
5	38	38	850	40	120		139TA3809



EXHAUST TUBES

For all our latest catalogue updates and company info: www.tvh.com

EXHAUST TUBES

used for: **BAUMANN**

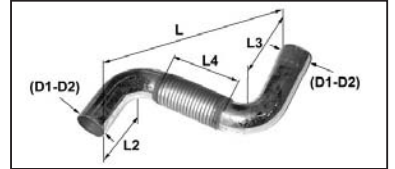

Number of bends AT-BO	Smallest outer dia. tube (mm) D1	Largest outer dia. tube (mm) D2	Dimension (mm) L	Dimension (mm) L2	Dimension (mm) L3	Dimension (mm) L4	REF
1	55	58	175	90	120		134TA6018
2	60	63	435	55	85	270	134TA6027



REF [134TA6018](#)

REF [134TA6027](#)

EXHAUST TUBES

For all our latest catalogue updates and company info: www.tvh.com



EXHAUST TUBES

used for: **BOBCAT**

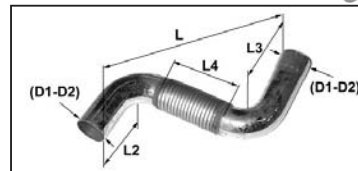

Number of bends AT-BO	Smallest outer dia. tube (mm) D1	Largest outer dia. tube (mm) D2	Dimension (mm) L	Dimension (mm) L2	Dimension (mm) L3	Dimension (mm) L4	REF
0	35	35	85				139TA3810
1	41	45	405	80	370	215	134TA5794
	45	49	265	60	265		139TA3811
2	35	38	400	60	75		134TA6347
	38	38	397	50	105		134TA5769
	43	44	260	70	300	195	134TA6314
	44	44	340	30	40	210	139TA3812
	44	44	485	60	60	285	134TA5787
	45	45	360	60	185		139TA3813
	50	50	345	80	80	210	139TA3814
	57	58	450	85	145	295	139TA3815
	62	64	775	60	90		139TA3816



REF [139TA3810](#)



REF [134TA5794](#)



REF [139TA3811](#)



REF [134TA6347](#)



REF [134TA5769](#)



REF [134TA6314](#)



REF [139TA3812](#)



REF [134TA5787](#)



REF [139TA3813](#)



REF [139TA3814](#)



REF [139TA3815](#)



REF [139TA3816](#)

EXHAUST TUBES

For all our latest catalogue updates and company info: www.tvh.com

EXHAUST TUBES

used for: **BOBCAT**

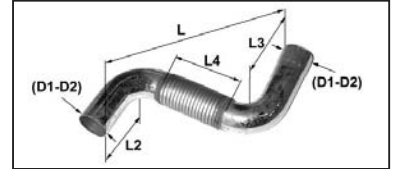

Number of bends AT-BO	Smallest outer dia. tube (mm) D1	Largest outer dia. tube (mm) D2	Dimension (mm) L	Dimension (mm) L2	Dimension (mm) L3	Dimension (mm) L4	REF
2	63	64	305	90	150		134TA6164
3	44	44	410	30	45	255	134TA6113
	44	44	440	45	50	230	134TA5653
	59	60	420	50	60	150	139TA3817
	63	65	360	30	100		139TA3818



EXHAUST TUBES

For all our latest catalogue updates and company info: www.tvh.com



EXHAUST TUBES

used for: **CLARK-SAMSUNG**

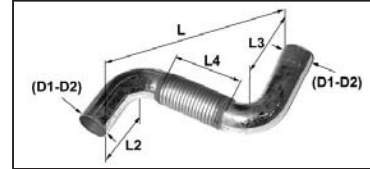

Number of bends AT-BO	Smallest outer dia. tube (mm) D1	Largest outer dia. tube (mm) D2	Dimension (mm) L	Dimension (mm) L2	Dimension (mm) L3	Dimension (mm) L4	REF	
0	35	35	85				139TA3838	
	38	38	285				105TA7381	
	42	42	225				105TA7459	
	48	62	50				118TA1606	
	55	55	240				123TA6589	
	63	63	155			70	105TA7049	
	76	76	405			300	123TA6590	
	76	80	1410				118TA1702	
	88	88	125				105TA7367	
	98	102	690				123TA6591	
	1	36	38	75	26	52		118TA1591
		37	37	240	85	175		105TA7368



EXHAUST TUBES

For all our latest catalogue updates and company info: www.tvh.com

used for: **CLARK-SAMSUNG**

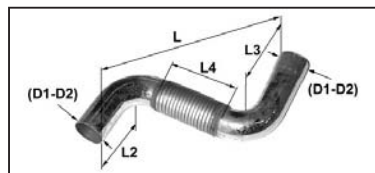

EXHAUST TUBES

Number of bends AT-BO	Smallest outer dia. tube (mm) D1	Largest outer dia. tube (mm) D2	Dimension (mm) L	Dimension (mm) L2	Dimension (mm) L3	Dimension (mm) L4	REF
1	38	38	165	50	140		139TA3839
	38	48	270	40	240		134TA5856
	39	41	230	85	200		134TA5747
	41	45	405	80	370	215	134TA5793
	42	42	290	115	240		105TA7393
	42	45	640	405	505	135	139TA3840
	43	48	340	110	240	210	139TA3841
	44	44	79	42	42		134TA5718
	44	44	100	42	65		118TA1663
	44	48	205	115	130		105TA6945
	44	50	255	80	220		108TA4544
	45	45	215	54	170	70	105TA7010

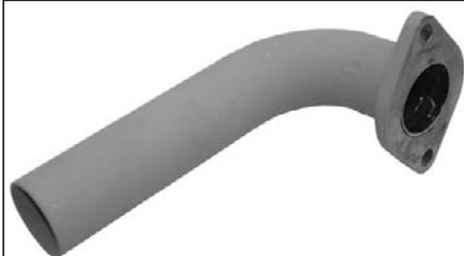

REF [139TA3839](#)



REF [134TA5856](#)



REF [134TA5747](#)



REF [134TA5793](#)



REF [105TA7393](#)



REF [139TA3840](#)



REF [139TA3841](#)



REF [134TA5718](#)



REF [118TA1663](#)



REF [105TA6945](#)



REF [108TA4544](#)



REF [105TA7010](#)

EXHAUST TUBES

For all our latest catalogue updates and company info: www.tvh.com



EXHAUST TUBES

used for: **CLARK-SAMSUNG**

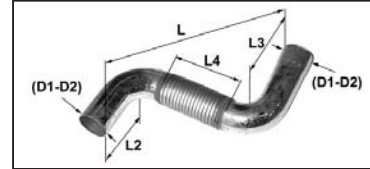

Number of bends AT-BO	Smallest outer dia. tube (mm) D1	Largest outer dia. tube (mm) D2	Dimension (mm) L	Dimension (mm) L2	Dimension (mm) L3	Dimension (mm) L4	REF
1	45	50	242	90	190		118TA1472
	46	46	140	20	125		105TA7028
	47	50	210	65	145	145	139TA3842
	48	48	115	55	80		105TA6983
	48	52	240	70	195		105TA7011
	48	52	345	115	135		105TA7025
	48	52	430	95	410		124TA7626
	49	51	290	110	135		105TA7402
	50	51	92	45	65		124TA2101
	50	55	705	45	670		118TA1552
	51	51	62	35	46		108TA4375
	51	51	240	110	145		123TA6592

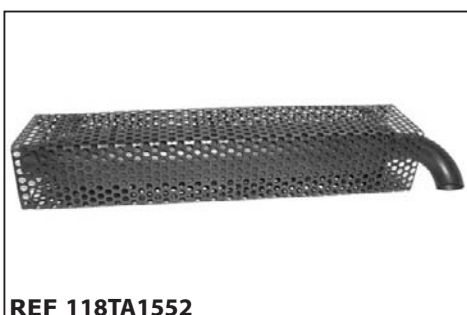

EXHAUST TUBES

For all our latest catalogue updates and company info: www.tvh.com

used for: **CLARK-SAMSUNG**

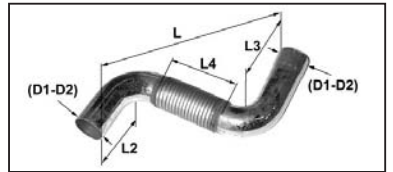

EXHAUST TUBES

Number of bends AT-BO	Smallest outer dia. tube (mm) D1	Largest outer dia. tube (mm) D2	Dimension (mm) L	Dimension (mm) L2	Dimension (mm) L3	Dimension (mm) L4	REF
1	51	55	180	120	155		134TA5789
	51	55	245	90	190		105TA7386
	51	60	665	85	630		105TA7335
	51	62	130	110	180		105TA7099
	54	78	786	37	760		118TA1539
	55	55	360	150	265		118TA1610
	55	77	712	40	685		105TA6779
	56	56	145	70	105		105TA6916
	57	63	207	110	115		139TA3843
	60	60	170	65	120		134TA5890
	60	61	92	18	76		139TA3844
	60	70	195	60	160		105TA7366



EXHAUST TUBES

For all our latest catalogue updates and company info: www.tvh.com



EXHAUST TUBES

used for: **CLARK-SAMSUNG**

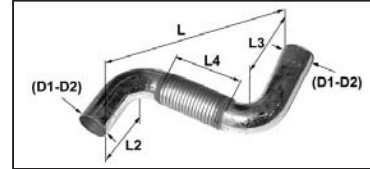

Number of bends	Smallest outer dia. tube (mm)	Largest outer dia. tube (mm)	Dimension (mm)	Dimension (mm)	Dimension (mm)	Dimension (mm)	REF
AT-BO	D1	D2	L	L2	L3	L4	
1	64	64	110	15	95		105TA7305
	64	64	1060	90	1015		134TA5705
	64	68	126	10	120		134TA5944
	70	70	140	80	95		134TA6037
	76	76	190	120	120		139TA3845
	76	76	288	105	188		118TA1626
	76	76	790	50	750		105TA7173
	76	76	790	60	740		139TA3846
	77	84	185	55	150		105TA7370
	80	88	210	125	140		105TA6917
2	26	29	500	180	195		105TA6957
	29	29	380	80	170		105TA7409



REF [105TA7305](#)



REF [134TA5705](#)



REF [134TA5944](#)



REF [134TA6037](#)



REF [139TA3845](#)

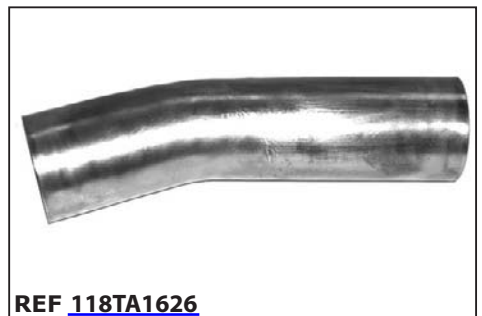

REF [118TA1626](#)



REF [105TA7173](#)



REF [139TA3846](#)



REF [105TA7370](#)



REF [105TA6917](#)

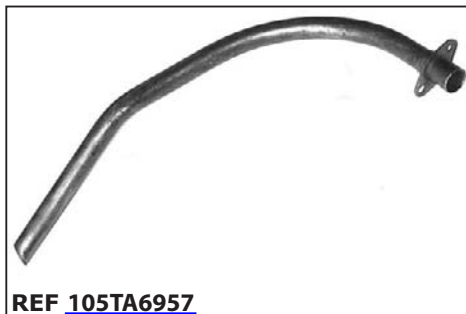

REF [105TA6957](#)



REF [105TA7409](#)

EXHAUST TUBES

For all our latest catalogue updates and company info: www.tvh.com

used for: **CLARK-SAMSUNG**

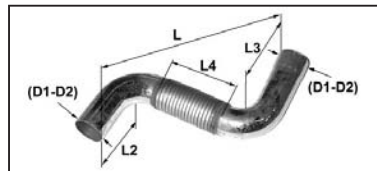

EXHAUST TUBES

Number of bends AT-BO	Smallest outer dia. tube (mm) D1	Largest outer dia. tube (mm) D2	Dimension (mm) L	Dimension (mm) L2	Dimension (mm) L3	Dimension (mm) L4	REF
2	32	32	178	80	90		118TA1531
	32	32	278	70	98		118TA1589
	35	38	400	60	75		134TA6346
	36	38	250	35	90		139TA3847
	38	38	130	30	35		105TA7303
	38	38	250	105	115		105TA7365
	38	38	330	35	150		105TA7044
	38	38	395	85	200		134TA5743
	38	40	245	75	95		134TA6110
	38	40	440	90	150		134TA6221
	38	47	580	35	65		134TA6264
	38	50	354	85	160		123TA6593



EXHAUST TUBES

For all our latest catalogue updates and company info: www.tvh.com



EXHAUST TUBES

used for: **CLARK-SAMSUNG**

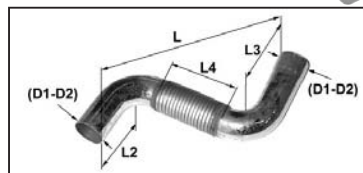

Number of bends AT-BO	Smallest outer dia. tube (mm) D1	Largest outer dia. tube (mm) D2	Dimension (mm) L	Dimension (mm) L2	Dimension (mm) L3	Dimension (mm) L4	REF
2	38	50	400	90	205		124TA2884
	41	46	200	75	215		139TA3848
	42	44	424	60	250		108TA4540
	43	44	260	70	300	195	134TA6312
	43	50	355	50	95	185	106TA5017
	44	44	230	35	100		105TA7091
	44	44	485	60	60	285	134TA5786
	44	48	275	90	100		134TA6319
	44	49	240	20	195		105TA7369
	44	75	245	70	135		105TA7379
	45	45	295	30	80		105TA7411
	45	51	295	95	105		124TA1046



EXHAUST TUBES

For all our latest catalogue updates and company info: www.tvh.com

used for: **CLARK-SAMSUNG**

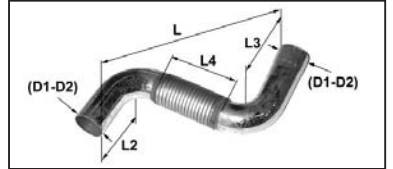

EXHAUST TUBES

Number of bends AT-BO	Smallest outer dia. tube (mm) D1	Largest outer dia. tube (mm) D2	Dimension (mm) L	Dimension (mm) L2	Dimension (mm) L3	Dimension (mm) L4	REF
2	48	48	320	50	55		134TA6154
	48	48	325	55	65		106TA6314
	48	48	385	75	220		105TA7382
	48	51	320	30	60	180	123TA6595
	48	51	368	110	135		110TA8587
	48	52	375	85	120		105TA7312
	49	51	275	55	150		105TA7310
	49	51	345	55	100		134TA5870
	50	50	220	60	115		105TA7383
	50	50	360	80	210		118TA1620
	50	51	1085	60	325		118TA1627
	50	53	240	110	150		118TA1611



EXHAUST TUBES

For all our latest catalogue updates and company info: www.tvh.com



EXHAUST TUBES

used for: **CLARK-SAMSUNG**

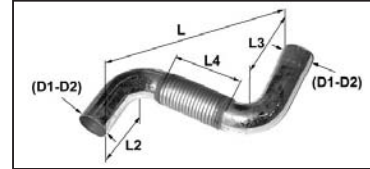

Number of bends AT-BO	Smallest outer dia. tube (mm) D1	Largest outer dia. tube (mm) D2	Dimension (mm) L	Dimension (mm) L2	Dimension (mm) L3	Dimension (mm) L4	REF
2	50	54	308	70	105		123TA6596
	50	55	230	115	180		105TA7376
	50	55	290	90	115		118TA1567
	50	55	390	65	110		123TA6597
	50	61	644	155	230		108TA4377
	51	51	187	30	110		118TA1622
	51	51	430	110	170		105TA6960
	51	51	460	145	210		118TA1492
	51	51	465	35	275	250	105TA7214
	51	51	790	370	495		134TA6190
	51	51	1190	60	225		118TA1639
	51	51	1220	65	225		124TA2071

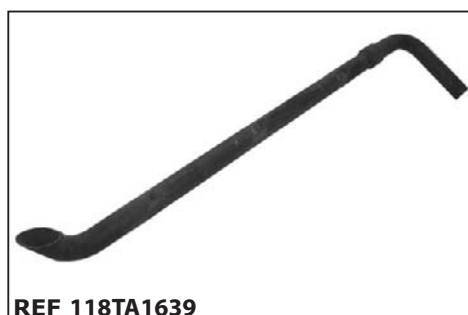

EXHAUST TUBES

For all our latest catalogue updates and company info: www.tvh.com

used for: **CLARK-SAMSUNG**

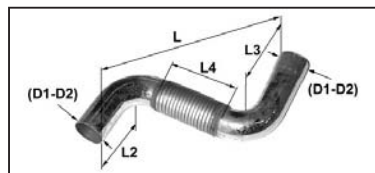

EXHAUST TUBES

Number of bends AT-BO	Smallest outer dia. tube (mm) D1	Largest outer dia. tube (mm) D2	Dimension (mm) L	Dimension (mm) L2	Dimension (mm) L3	Dimension (mm) L4	REF
2	51	54	225	52	136		108TA8280
	51	54	680	138	145		118TA1572
	51	55	455	75	93		123TA6598
	51	55	645	110	130		105TA7333
	51	55	840	200	505		118TA1554
	51	56	790	145	315		139TA3849
	51	62	410	46	210		124TA2100
	54	54	405	85	300	170	118TA1608
	54	54	1250	180	200		124TA4496
	57	57	220	80	120		139TA3850
	57	58	450	85	145	295	139TA3851
	57	63	400	110	115		105TA7163



REF [108TA8280](#)



REF [118TA1572](#)



REF [123TA6598](#)



REF [105TA7333](#)

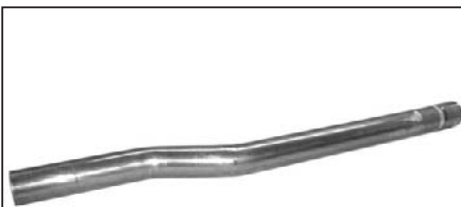

REF [118TA1554](#)



REF [139TA3849](#)



REF [124TA2100](#)



REF [118TA1608](#)



REF [124TA4496](#)



REF [139TA3850](#)



REF [139TA3851](#)



REF [105TA7163](#)

EXHAUST TUBES

For all our latest catalogue updates and company info: www.tvh.com



EXHAUST TUBES

used for: **CLARK-SAMSUNG**

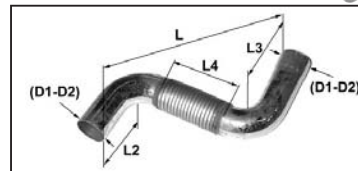

Number of bends AT-BO	Smallest outer dia. tube (mm) D1	Largest outer dia. tube (mm) D2	Dimension (mm) L	Dimension (mm) L2	Dimension (mm) L3	Dimension (mm) L4	REF
2	57	66	260	60	70		134TA6189
	60	60	325	15	140		134TA6072
	60	60	665	260	260		118TA1612
	60	60	675	200	200	70	110TA8598
	61	66	310	45	50		105TA6992
	62	63	405	105	270		105TA7377
	62	64	775	60	90		139TA3852
	62	64	1200	50	230		123TA6599
	63	63	310	45	70	185	134TA6008
	63	63	1050	90	800		124TA7628
	63	76	420	60	110		105TA7041
	64	64	405	50	245		105TA7055



REF [134TA6189](#)



REF [134TA6072](#)



REF [118TA1612](#)



REF [110TA8598](#)



REF [105TA6992](#)



REF [105TA7377](#)



REF [139TA3852](#)



REF [123TA6599](#)



REF [134TA6008](#)



REF [124TA7628](#)



REF [105TA7041](#)



REF [105TA7055](#)

EXHAUST TUBES

For all our latest catalogue updates and company info: www.tvh.com

used for: **CLARK-SAMSUNG**

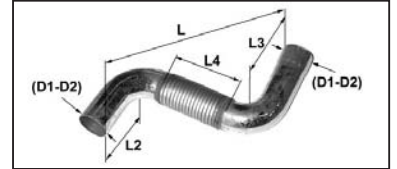

EXHAUST TUBES

Number of bends AT-BO	Smallest outer dia. tube (mm) D1	Largest outer dia. tube (mm) D2	Dimension (mm) L	Dimension (mm) L2	Dimension (mm) L3	Dimension (mm) L4	REF
2	64	64	412	55	185		123TA6600
	64	76	345	100	195		105TA7375
	65	65	1495	50	145		105TA6997
	75	78	480	95	205		105TA7273
	76	76	385	95	120		105TA7313
	76	80	545	70	285		139TA3853
	76	81	325	130	160		105TA7037
	76	81	500	125	185	160	105TA7276
3	32	32	680	45	105		105TA7338
	38	38	485	85	215		124TA1084
	38	38	495	145	200		105TA7283
	38	38	503	70	200		108TA4453



EXHAUST TUBES

For all our latest catalogue updates and company info: www.tvh.com



EXHAUST TUBES

used for: **CLARK-SAMSUNG**

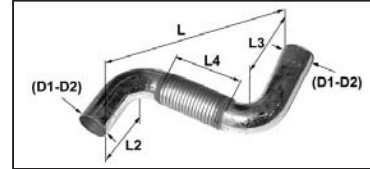

Number of bends AT-BO	Smallest outer dia. tube (mm) D1	Largest outer dia. tube (mm) D2	Dimension (mm) L	Dimension (mm) L2	Dimension (mm) L3	Dimension (mm) L4	REF
3	38	38	1100	55	115		124TA1117
	38	38	1180	45	185		124TA5157
	38	38	1235	75	180		134TA5823
	38	39	1185	65	118		118TA1644
	39	39	405	95	185		105TA7344
	39	39	470	60	140		134TA6308
	39	39	475	45	195		123TA6601
	39	41	340	85	210		139TA3854
	39	45	340	60	85		105TA7302
	39	55	450	60	80		123TA6602
	41	41	445	85	140		105TA7387
	42	47	587	80	420	150	139TA3855

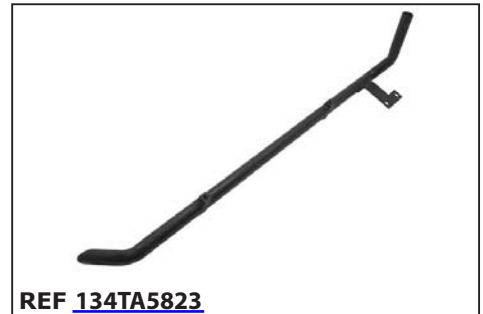

EXHAUST TUBES

For all our latest catalogue updates and company info: www.tvh.com

used for: **CLARK-SAMSUNG**

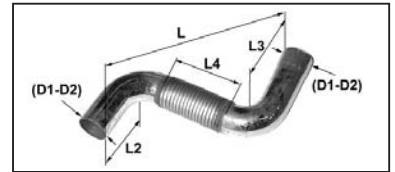

EXHAUST TUBES

Number of bends AT-BO	Smallest outer dia. tube (mm) D1	Largest outer dia. tube (mm) D2	Dimension (mm) L	Dimension (mm) L2	Dimension (mm) L3	Dimension (mm) L4	REF
3	43	45	500	75	85		118TA1598
	44	44	410	30	45	255	134TA6111
	44	44	440	45	50	230	118TA1551
	44	45	310	35	40		134TA6086
	45	48	310	40	45		118TA1520
	45	48	530	70	115		134TA6357
	45	50	555	65	215		134TA6048
	48	48	425	30	80		123TA6603
	48	49	450	45	95		105TA7149
	48	59	565	30	155	100	110TA8600
	50	50	495	80	120		105TA7233
	50	50	865	45	460		105TA7287



EXHAUST TUBES

For all our latest catalogue updates and company info: www.tvh.com



EXHAUST TUBES

used for: **CLARK-SAMSUNG**

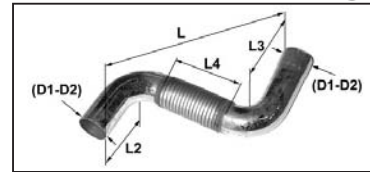

Number of bends AT-BO	Smallest outer dia. tube (mm) D1	Largest outer dia. tube (mm) D2	Dimension (mm) L	Dimension (mm) L2	Dimension (mm) L3	Dimension (mm) L4	REF
3	50	51	572	45	200		123TA6604
	50	51	1130	40	70		105TA7175
	50	54	383	110	145		118TA1560
	50	54	490	90	120		134TA6015
	50	54	1005	100	690		134TA6014
	50	57	475	20	225	140	105TA6965
	50	64	405	80	175		105TA7094
	51	51	275	30	55		105TA7404
	51	51	450	90	100		105TA7246
	51	51	520	25	220		105TA7342
	51	51	595	70	110		123TA6605
	51	51	610	90	150		118TA1473



REF [123TA6604](#)



REF [105TA7175](#)

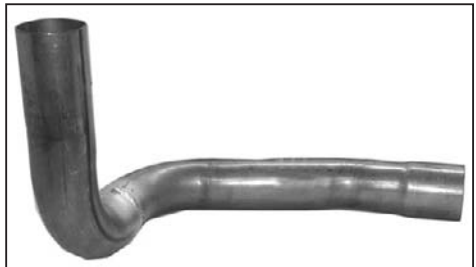

REF [118TA1560](#)



REF [134TA6015](#)



REF [134TA6014](#)

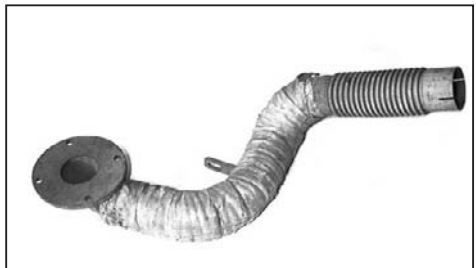

REF [105TA6965](#)



REF [105TA7094](#)



REF [105TA7404](#)



REF [105TA7246](#)



REF [105TA7342](#)



REF [123TA6605](#)

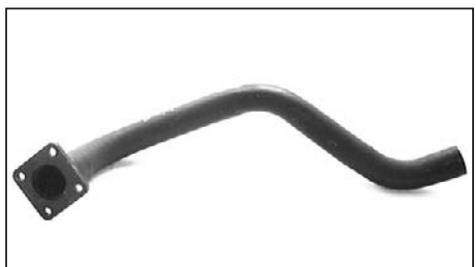

REF [118TA1473](#)

EXHAUST TUBES

For all our latest catalogue updates and company info: www.tvh.com

used for: **CLARK-SAMSUNG**

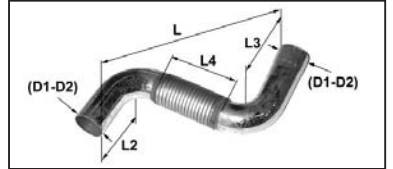

EXHAUST TUBES

Number of bends AT-BO	Smallest outer dia. tube (mm) D1	Largest outer dia. tube (mm) D2	Dimension (mm) L	Dimension (mm) L2	Dimension (mm) L3	Dimension (mm) L4	REF
3	51	51	910	235	305		105TA7208
	51	52	1100	50	320		134TA5947
	51	55	425	155	190		118TA1594
	51	63	475	20	100		123TA6606
	51	63	588	43	207		110TA8592
	55	65	655	150	270		134TA5894
	55	67	645	140	270	145	118TA1605
	57	57	490	100	100		105TA7329
	57	74	840	170	205		105TA7156
	60	63	400	30	125		134TA6279
	60	75	495	105	130	90	123TA6607
	62	63	1362	30	110		118TA1619

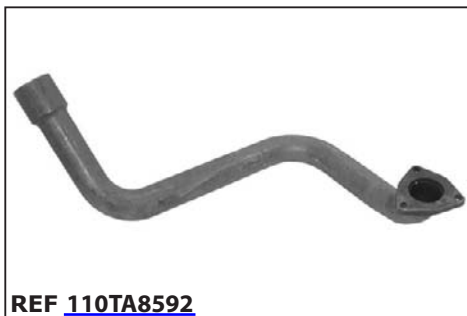

EXHAUST TUBES

For all our latest catalogue updates and company info: www.tvh.com



EXHAUST TUBES

used for: **CLARK-SAMSUNG**

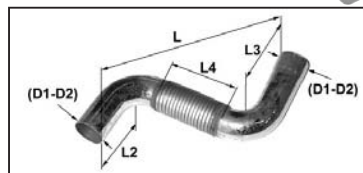

Number of bends AT-BO	Smallest outer dia. tube (mm) D1	Largest outer dia. tube (mm) D2	Dimension (mm) L	Dimension (mm) L2	Dimension (mm) L3	Dimension (mm) L4	REF
3	63	63	480	70	210		118TA1693
	63	63	485	45	270		105TA6963
	63	77	450	35	160		105TA7323
	75	75	815	115	540		105TA6998
	75	80	982	142	155		134TA5724
	76	76	780	80	520		105TA7176
4	36	51	1555	50	80		134TA6103
	38	38	470	90	100		134TA5921
	38	38	482	45	60		134TA6294
	38	39	450	85	210		105TA7255
	38	46	378	30	75		139TA3856
	39	50	1195	40	180		124TA1080



EXHAUST TUBES

For all our latest catalogue updates and company info: www.tvh.com

used for: **CLARK-SAMSUNG**

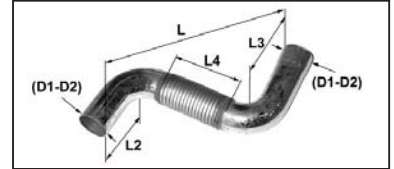

EXHAUST TUBES

Number of bends AT-BO	Smallest outer dia. tube (mm) D1	Largest outer dia. tube (mm) D2	Dimension (mm) L	Dimension (mm) L2	Dimension (mm) L3	Dimension (mm) L4	REF
4	40	42	750	45	120	140	134TA5911
	40	52	1205	50	80		134TA5712
	41	42	410	35	75	135	134TA5915
	42	42	720	40	165	140	134TA5811
	42	57	730	125	130	170	134TA5657
	45	50	540	65	160		134TA6195
	45	50	545	70	148		118TA1648
	45	51	735	60	90		123TA6608
	48	48	770	50	80		124TA4494
	48	51	1015	55	110		134TA5822
	48	52	510	65	125		124TA7627
	48	54	613	30	100	145	139TA3857

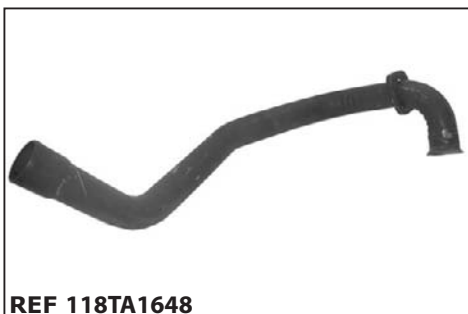
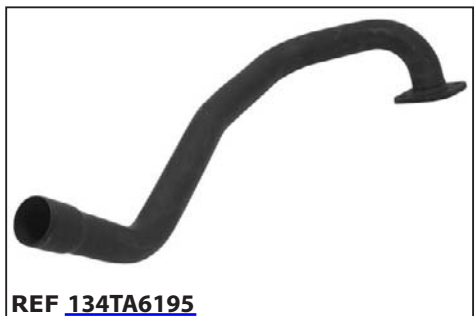

EXHAUST TUBES

For all our latest catalogue updates and company info: www.tvh.com



EXHAUST TUBES

used for: **CLARK-SAMSUNG**

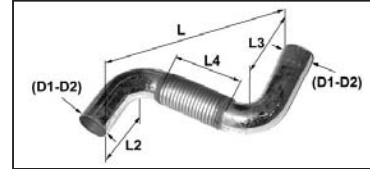

Number of bends	Smallest outer dia. tube (mm)	Largest outer dia. tube (mm)	Dimension (mm)	Dimension (mm)	Dimension (mm)	Dimension (mm)	REF
AT-BO	D1	D2	L	L2	L3	L4	
4	50	50	465	40	70		134TA5875
	50	55	675	95	100		118TA1536
	51	51	530	95	120		105TA7210
	51	51	630	37	165		134TA6213
	51	51	703	110	160		108TA4478
	51	51	710	50	110		124TA2871
	51	51	990	75	100		139TA3858
	51	53	1555	50	90		108TA4469
	54	63	625	120	145	150	123TA6609
	54	63	630	100	140	140	123TA6610
	76	76	820	100	110		118TA1542
5	37	39	795	30	75		134TA6155

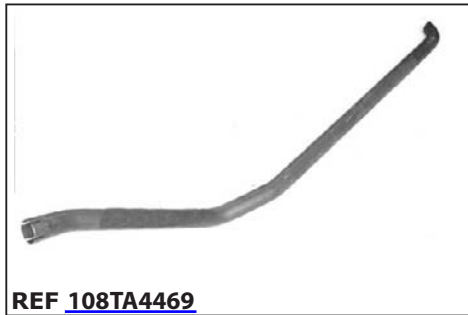
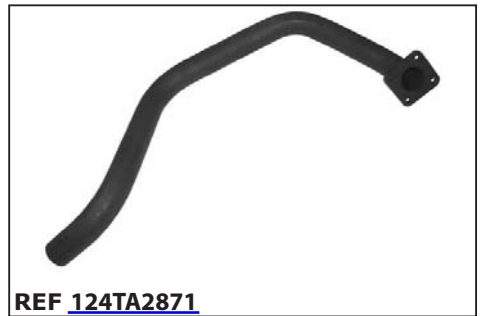

EXHAUST TUBES

For all our latest catalogue updates and company info: www.tvh.com

used for: **CLARK-SAMSUNG**

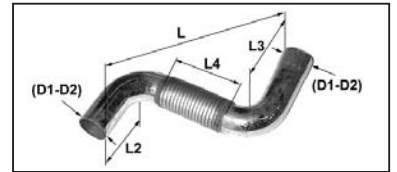

EXHAUST TUBES

Number of bends AT-BO	Smallest outer dia. tube (mm) D1	Largest outer dia. tube (mm) D2	Dimension (mm) L	Dimension (mm) L2	Dimension (mm) L3	Dimension (mm) L4	REF
5	39	39	750	20	70		124TA2105
	40	40	580	30	90		134TA5863
	41	42	590	70	120	135	134TA5903
	42	42	550	50	125	130	134TA5907
	42	57	625	50	390	140	139TA3859
	44	51	470	60	70		105TA7328
	51	51	530	100	115		105TA7042
	62	88	775	65	95		134TA5621
	68	89	705	45	90		108TA4526
6	43	54	440	20	98		110TA9611
	45	45	6156	10	120		105TA7211
7	48	48	710	75	90	145	118TA1604



EXHAUST TUBES

For all our latest catalogue updates and company info: www.tvh.com



EXHAUST TUBES

used for: **COVENTRY CLIMAX**

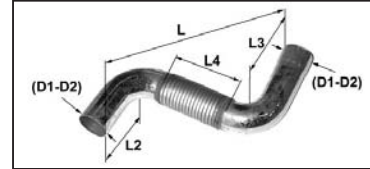

Number of bends AT-BO	Smallest outer dia. tube (mm) D1	Largest outer dia. tube (mm) D2	Dimension (mm) L	Dimension (mm) L2	Dimension (mm) L3	Dimension (mm) L4	REF
0	39	39	500				124TA7244
	44	44	1125				134TA6156
	45	47	140				118TA1555
	45	50	585			465	134TA6325
	57	57	193				124TA7238
	57	57	495				124TA7240
	75	124	325				108TA4524
1	45	45	345	70	270	205	123TA6611
	45	47	445	75	385	310	118TA1528
	48	48	825	15			134TA6323
	49	49	360	210	250		134TA6120
	49	51	237	76	207		118TA1559

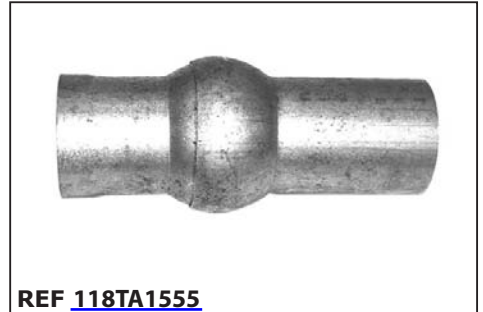

EXHAUST TUBES

For all our latest catalogue updates and company info: www.tvh.com

used for: **COVENTRY CLIMAX**

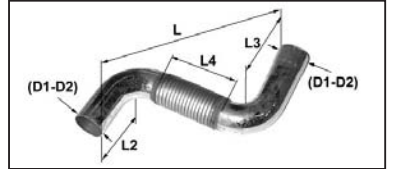

EXHAUST TUBES

Number of bends AT-BO	Smallest outer dia. tube (mm) D1	Largest outer dia. tube (mm) D2	Dimension (mm) L	Dimension (mm) L2	Dimension (mm) L3	Dimension (mm) L4	REF
1	50	51	860	90	830	690	134TA5898
	51	51	135	30	113		108TA4398
	51	51	145	80	80		134TA5702
	51	51	445	53	413	350	118TA1595
	51	56	132	43	86		134TA5710
	55	51	305	150	225		124TA7237
	102	102	2760	120	2720		124TA1068
	102	124	515	80	503		110TA9616
2	40	43	200	40	95		134TA5598
	41	41	198	25	150		111TA1917
	42	42	460	65	380		105TA7345
	45	45	135	105	130		118TA1692



EXHAUST TUBES

For all our latest catalogue updates and company info: www.tvh.com



EXHAUST TUBES

used for: **COVENTRY CLIMAX**

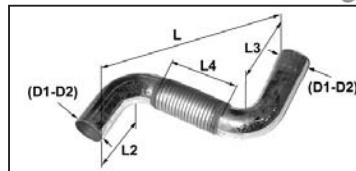

Number of bends AT-BO	Smallest outer dia. tube (mm) D1	Largest outer dia. tube (mm) D2	Dimension (mm) L	Dimension (mm) L2	Dimension (mm) L3	Dimension (mm) L4	REF
2	45	45	290	60	85		134TA6133
	45	45	448	100	105		108TA4451
	50	51	520	70	465	340	134TA6093
	50	54	765	140	195	340	123TA6612
3	41	54	1083	45	705		123TA6613
	42	47	530	110	120		106TA5030
4	45	45	635	60	120		105TA6988
5	42	42	645	50	80		105TA7264
	68	89	705	45	90		108TA4527

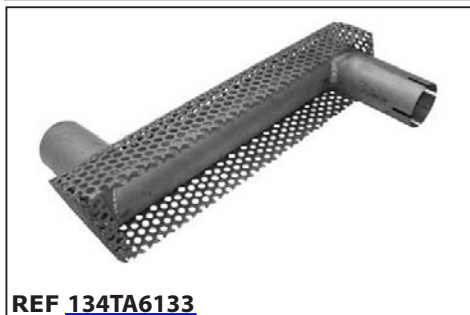

EXHAUST TUBES

For all our latest catalogue updates and company info: www.tvh.com

EXHAUST TUBES

used for: **CROWN**

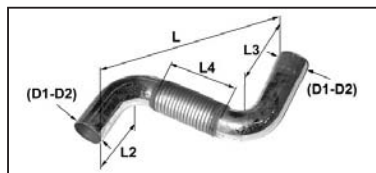

Number of bends AT-BO	Smallest outer dia. tube (mm) D1	Largest outer dia. tube (mm) D2	Dimension (mm) L	Dimension (mm) L2	Dimension (mm) L3	Dimension (mm) L4	REF
1	42	42	328	75	255	140	139TA3860



Look up these parts via

EXHAUST TUBES

For all our latest catalogue updates and company info: www.tvh.com



EXHAUST TUBES

used for: **DANTRUCK**

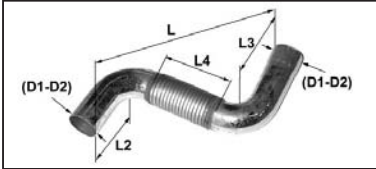

Number of bends AT-BO	Smallest outer dia. tube (mm) D1	Largest outer dia. tube (mm) D2	Dimension (mm) L	Dimension (mm) L2	Dimension (mm) L3	Dimension (mm) L4	REF
1	60	76	190	130	210		134TA5983



EXHAUST TUBES

For all our latest catalogue updates and company info: www.tvh.com

EXHAUST TUBES

used for: **DESTA**

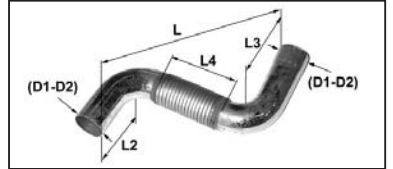

Number of bends AT-BO	Smallest outer dia. tube (mm) D1	Largest outer dia. tube (mm) D2	Dimension (mm) L	Dimension (mm) L2	Dimension (mm) L3	Dimension (mm) L4	REF
1	51	58	117	62	94		118TA1519
3	40	40	1230	40	850	180	104TA5969



EXHAUST TUBES



For all our latest catalogue updates and company info: www.tvh.com

used for: **DIECI**

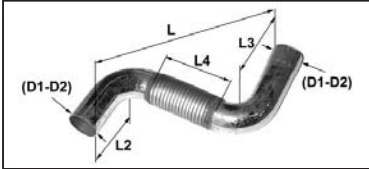

EXHAUST TUBES

Number of bends AT-BO	Smallest outer dia. tube (mm) D1	Largest outer dia. tube (mm) D2	Dimension (mm) L	Dimension (mm) L2	Dimension (mm) L3	Dimension (mm) L4	REF
2	65	65	550	110	150		134TA6271
	65	67	1480	85	375	975	134TA6083





EXHAUST TUBES

For all our latest catalogue updates and company info: www.tvh.com

EXHAUST TUBES

used for: **FANTUZZI**

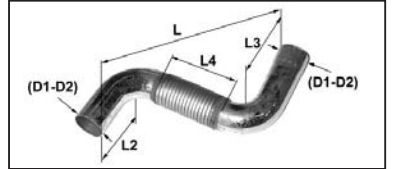

Number of bends AT-BO	Smallest outer dia. tube (mm) D1	Largest outer dia. tube (mm) D2	Dimension (mm) L	Dimension (mm) L2	Dimension (mm) L3	Dimension (mm) L4	REF
1	70	76	123	40	135		134TA6211
2	29	29	380	80	170		139TA3861



REF [134TA6211](#)



REF [139TA3861](#)

EXHAUST TUBES

For all our latest catalogue updates and company info: www.tvh.com



EXHAUST TUBES

used for: **FENWICK & PEG**

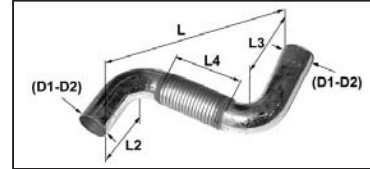

Number of bends AT-BO	Smallest outer dia. tube (mm) D1	Largest outer dia. tube (mm) D2	Dimension (mm) L	Dimension (mm) L2	Dimension (mm) L3	Dimension (mm) L4	REF
0	45	45	1035				105TA7235
	59	59	232			147	134TA5616
1	40	46	1710	53	1680	825	134TA5665
	42	42	472	460	40	410	134TA5619
	43	45	480	35	470	445	105TA7358
	48	48	215	90	105		108TA4393
	50	52	210	90	175		105TA7355
	56	59	610	145	480		105TA7232
2	45	48	400	80	450		105TA7039
	48	49	215	20	65		105TA7395
	56	60	370	65	70		134TA5932
3	60	79	1775	30	125		134TA5674

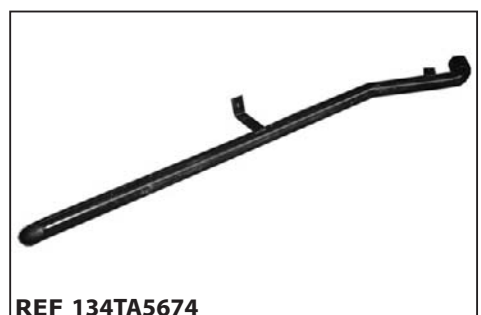
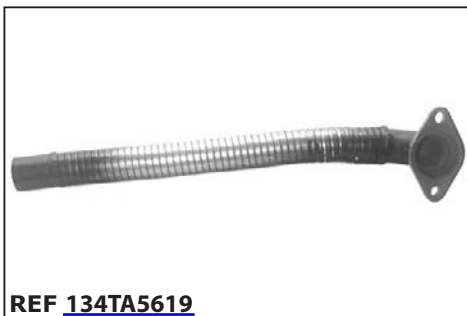

EXHAUST TUBES



For all our latest catalogue updates and company info: www.tvh.com

EXHAUST TUBES

used for: **FENWICK & PEG**

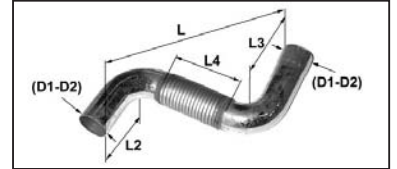

Number of bends AT-BO	Smallest outer dia. tube (mm) D1	Largest outer dia. tube (mm) D2	Dimension (mm) L	Dimension (mm) L2	Dimension (mm) L3	Dimension (mm) L4	REF
4	55	58	1067	20	165		134TA5636



EXHAUST TUBES

For all our latest catalogue updates and company info: www.tvh.com



EXHAUST TUBES

used for: **GENIE**

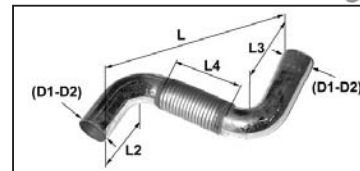

Number of bends AT-BO	Smallest outer dia. tube (mm) D1	Largest outer dia. tube (mm) D2	Dimension (mm) L	Dimension (mm) L2	Dimension (mm) L3	Dimension (mm) L4	REF
1	51	63	250	105	140	65	134TA6174
	69	74	705	20	690	535	134TA5889
	70	84	185	110	115		139TA3862
	125	125	75	40	40		134TA6035
2	35	35	245	63	67		134TA6348
	39	38	390	35	240		139TA3863
	48	48	570	140	310		134TA6040
	63	63	320	60	140		134TA6173
	76	82	1360	115	260		139TA3864
	48	48	650	25	200		134TA6162
3	48	48	650	25	250		134TA6047
	50	50	375	20	120		134TA6016



REF [134TA6174](#)



REF [134TA5889](#)



REF [139TA3862](#)



REF [134TA6035](#)



REF [134TA6348](#)



REF [139TA3863](#)



REF [134TA6040](#)

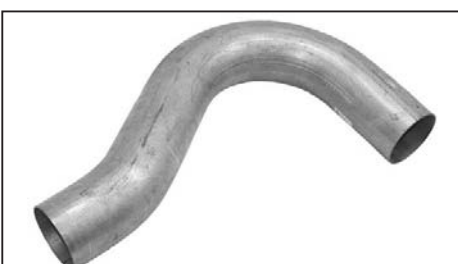

REF [134TA6173](#)



REF [139TA3864](#)



REF [134TA6162](#)

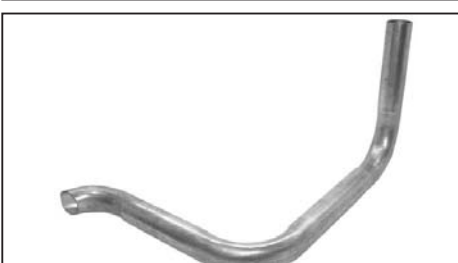

REF [134TA6047](#)

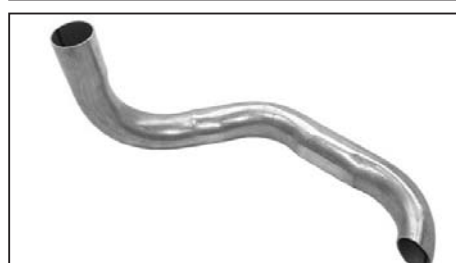

REF [134TA6016](#)

EXHAUST TUBES

For all our latest catalogue updates and company info: www.tvh.com

EXHAUST TUBES

used for: **GENIE**

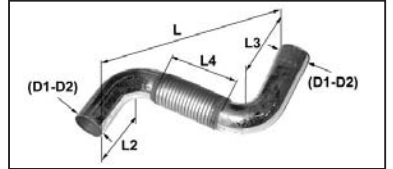

Number of bends AT-BO	Smallest outer dia. tube (mm) D1	Largest outer dia. tube (mm) D2	Dimension (mm) L	Dimension (mm) L2	Dimension (mm) L3	Dimension (mm) L4	REF
4	47	55	565	40	170		134TA6039



REF [134TA6039](#)

EXHAUST TUBES

For all our latest catalogue updates and company info: www.tvh.com



EXHAUST TUBES

used for: **GROVE**

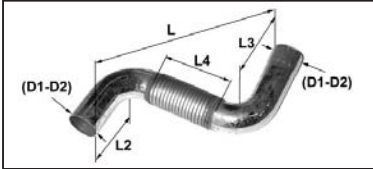

Number of bends	Smallest outer dia. tube (mm)	Largest outer dia. tube (mm)	Dimension (mm)	Dimension (mm)	Dimension (mm)	Dimension (mm)	REF
AT-BO	D1	D2	L	L2	L3	L4	
1	64	69	235	80	210		134TA6204
4	63	68	510	40	100		139TA3865



EXHAUST TUBES

For all our latest catalogue updates and company info: www.tvh.com

EXHAUST TUBES

used for: **HANGZHOU / HC / HANGCHA**

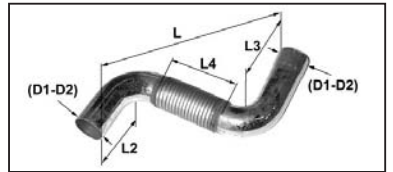

Number of bends AT-BO	Smallest outer dia. tube (mm) D1	Largest outer dia. tube (mm) D2	Dimension (mm) L	Dimension (mm) L2	Dimension (mm) L3	Dimension (mm) L4	REF
2	40	45	570	80	275		139TA3866
	40	45	575	85	290		134TA6167
	42	38	515	115	270		139TA3867
	42	42	570	85	270		134TA6193
3	36	42	750	45	140		139TA3868
4	41	41	420	60	150		134TA6236
6	41	41	600	35	50		134TA6166
7	42	42	800	30	60		134TA6163

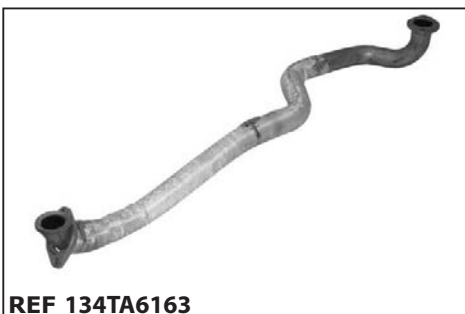
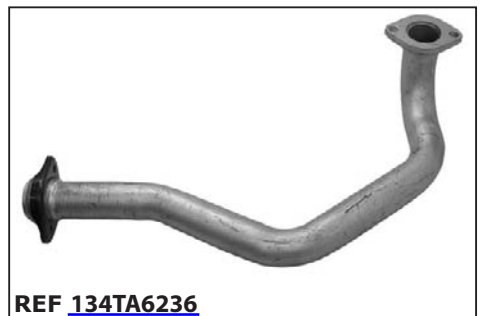

EXHAUST TUBES

For all our latest catalogue updates and company info: www.tvh.com



EXHAUST TUBES

used for: **HARLAN**

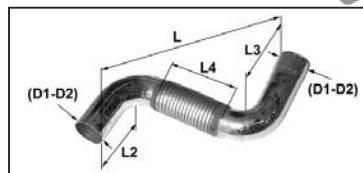

Number of bends AT-BO	Smallest outer dia. tube (mm) D1	Largest outer dia. tube (mm) D2	Dimension (mm) L	Dimension (mm) L2	Dimension (mm) L3	Dimension (mm) L4	REF
1	51	54	255	145	190		139TA3869
	62	64	280	115	225		139TA3870
	62	67	220	110	165		139TA3871
3	51	51	910	235	305		139TA3872



REF [139TA3869](#)



REF [139TA3870](#)



REF [139TA3871](#)



REF [139TA3872](#)

Look up these parts via

EXHAUST TUBES



For all our latest catalogue updates and company info: www.tvh.com

EXHAUST TUBES

used for: **HAULOTTE**

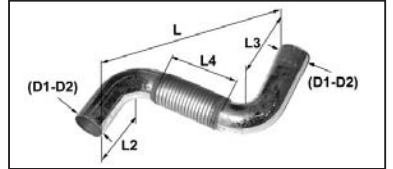

Number of bends AT-BO	Smallest outer dia. tube (mm) D1	Largest outer dia. tube (mm) D2	Dimension (mm) L	Dimension (mm) L2	Dimension (mm) L3	Dimension (mm) L4	REF
2	49	49	570	85	150		138TA7343
3	45	45	670	15	65		139TA3873



EXHAUST TUBES

For all our latest catalogue updates and company info: www.tvh.com



EXHAUST TUBES

used for: **HELI**

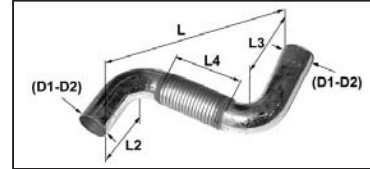

Number of bends AT-BO	Smallest outer dia. tube (mm) D1	Largest outer dia. tube (mm) D2	Dimension (mm) L	Dimension (mm) L2	Dimension (mm) L3	Dimension (mm) L4	REF
1	54	57	245	83	185		134TA5590
2	38	47	530	105	300	135	134TA5709
	53	70	490	170	190		134TA5596
	54	57	580	130	230	170	139TA3874
3	38	42	465	125	125		134TA5698
	54	57	660	40	120		139TA3875
4	38	38	670	90	105	140	134TA5704
5	33	33	580	80	105	80	134TA6309
	38	38	850	40	120		134TA5830
	42	42	610	15	140		139TA3876



EXHAUST TUBES

For all our latest catalogue updates and company info: www.tvh.com

used for: **HYSTER**

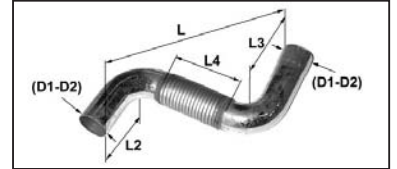

EXHAUST TUBES

Number of bends AT-BO	Smallest outer dia. tube (mm) D1	Largest outer dia. tube (mm) D2	Dimension (mm) L	Dimension (mm) L2	Dimension (mm) L3	Dimension (mm) L4	REF
0	36	37	200			145	105TA7394
	46	46	270			195	134TA6091
	46	46	355			285	105TA7113
	48	48	480			225	105TA7200
	50	55	140				108TA4381
	53	53	252			200	106TA6315
	53	54	308			230	108TA4446
	54	54	255			96	134TA6186
	63	63	115				110TA8591
	76	79	500				139TA3877
	107	107	330				139TA3878
1	32	32	93	42	60		118TA1680

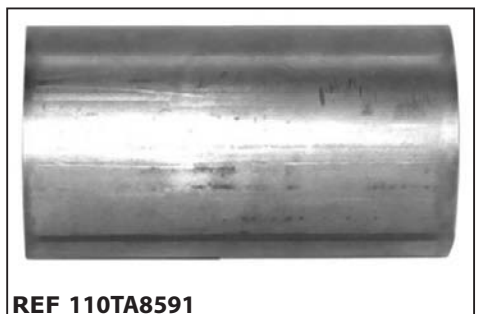
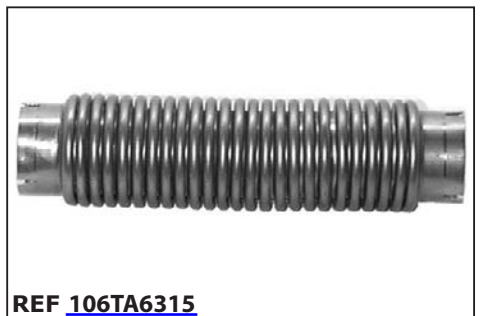

EXHAUST TUBES

For all our latest catalogue updates and company info: www.tvh.com



EXHAUST TUBES

used for: **HYSTER**

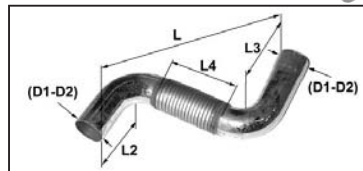

Number of bends AT-BO	Smallest outer dia. tube (mm) D1	Largest outer dia. tube (mm) D2	Dimension (mm) L	Dimension (mm) L2	Dimension (mm) L3	Dimension (mm) L4	REF
1	32	32	120	70	140		118TA1522
	32	35	108	95	125		105TA6888
	34	34	99	43	55		139TA3879
	35	35	62	29	32		134TA6065
	35	35	240	20	220		105TA7262
	38	38	130	50	145		139TA3880
	38	38	133	87	148		110TA8611
	38	44	400	165	345		118TA1694
	38	49	345	140	240	155	134TA6136
	39	39	210	80	230		105TA6927
	42	42	328	75	255	140	139TA3882
	42	45	400	165	345		123TA6617



EXHAUST TUBES

For all our latest catalogue updates and company info: www.tvh.com

EXHAUST TUBES

used for: **HYSTER**

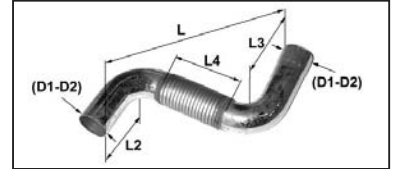

Number of bends AT-BO	Smallest outer dia. tube (mm) D1	Largest outer dia. tube (mm) D2	Dimension (mm) L	Dimension (mm) L2	Dimension (mm) L3	Dimension (mm) L4	REF
1	43	56	1020	110	1000		123TA6618
	44	44	150	20	130		105TA7410
	45	45	395	190	270		105TA7078
	45	48	195	110	140		105TA7160
	45	48	225	110	185		105TA7401
	45	49	400	160	345		124TA7616
	47	48	170	90	115		105TA7083
	47	50	360	115	275		108TA4554
	48	48	110	55	55		134TA5892
	48	48	280	70	210		105TA7293
	49	49	420	190	260		124TA4497
	50	50	120	80	115		105TA6954



EXHAUST TUBES

For all our latest catalogue updates and company info: www.tvh.com



EXHAUST TUBES

used for: **HYSTER**

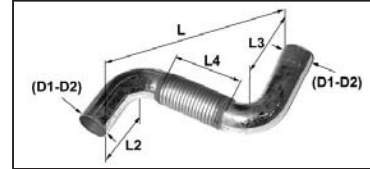

Number of bends AT-BO	Smallest outer dia. tube (mm) D1	Largest outer dia. tube (mm) D2	Dimension (mm) L	Dimension (mm) L2	Dimension (mm) L3	Dimension (mm) L4	REF
1	50	50	255	90	160		110TA8610
	50	54	470	95	435		105TA7157
	51	51	125	60	72		124TA7621
	51	51	128	40	90		134TA5871
	51	51	185	80	150		134TA6171
	51	51	195	55	150		139TA3883
	51	51	244	88	150		124TA2066
	51	51	260	80	250		105TA7074
	51	51	270	70	215		105TA7403
	51	51	285	95	195		139TA3884
	51	51	630	25	605		105TA6929
	51	54	470	100	430		105TA6949



EXHAUST TUBES

For all our latest catalogue updates and company info: www.tvh.com

EXHAUST TUBES

used for: **HYSTER**

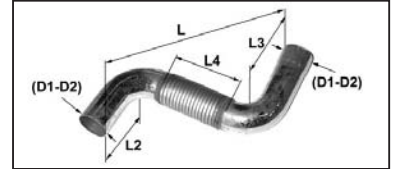

Number of bends AT-BO	Smallest outer dia. tube (mm) D1	Largest outer dia. tube (mm) D2	Dimension (mm) L	Dimension (mm) L2	Dimension (mm) L3	Dimension (mm) L4	REF
1	51	55	275	105	220		134TA6180
	51	58	400	40	370		105TA6902
	51	60	115	85	110		123TA6620
	51	72	230	140	155		134TA6178
	55	50	75	15	55		139TA3885
	55	55	380	240	260	185	105TA7141
	56	56	325	180	180		105TA7005
	57	57	155	55	115		105TA6942
	57	57	170	90	100		105TA7047
	57	64	117	55	72		134TA6038
	63	64	230	100	170		105TA7046
	64	64	213	95	155		105TA6889



EXHAUST TUBES

For all our latest catalogue updates and company info: www.tvh.com



EXHAUST TUBES

used for: **HYSTER**

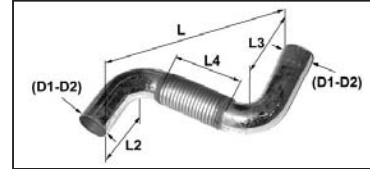

Number of bends AT-BO	Smallest outer dia. tube (mm) D1	Largest outer dia. tube (mm) D2	Dimension (mm) L	Dimension (mm) L2	Dimension (mm) L3	Dimension (mm) L4	REF
1	68	73	175	30	140		139TA3886
	69	89	220	125	145		105TA6909
	70	74	485	170	430		105TA7321
	70	74	490	205	460		139TA3887
	76	76	235	115	135		139TA3888
	76	76	270	95	225		105TA6975
	76	76	498	127	375		118TA1657
	76	76	1270	120	1180		139TA3889
	76	77	940	20	920		105TA7142
	76	80	175	90	130		105TA7114
	76	81	675	50	635		105TA6948
	76	89	250	125	175		105TA7301



EXHAUST TUBES

For all our latest catalogue updates and company info: www.tvh.com

used for: **HYSTER**

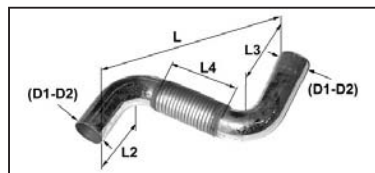

EXHAUST TUBES

Number of bends AT-BO	Smallest outer dia. tube (mm) D1	Largest outer dia. tube (mm) D2	Dimension (mm) L	Dimension (mm) L2	Dimension (mm) L3	Dimension (mm) L4	REF
1	98	105	440	95	405		105TA7036
	100	100	900	120	860		134TA6307
	100	105	190	115	115		105TA7116
	101	101	375	180	200		105TA7309
	101	101	685	110	650		105TA6946
2	29	29	380	80	170		124TA7615
	31	32	388	70	175		108TA4504
	32	32	170	70	110		105TA7318
	32	32	305	60	125		105TA7084
	32	32	390	95	100		105TA7063
	32	34	220	70	130		105TA6955
	32	34	460	70	120		105TA7164



EXHAUST TUBES

For all our latest catalogue updates and company info: www.tvh.com



EXHAUST TUBES

used for: **HYSTER**

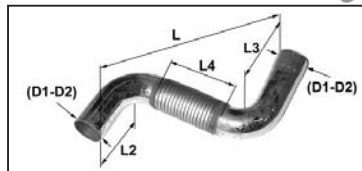

Number of bends AT-BO	Smallest outer dia. tube (mm) D1	Largest outer dia. tube (mm) D2	Dimension (mm) L	Dimension (mm) L2	Dimension (mm) L3	Dimension (mm) L4	REF
2	32	34	475	90	260		124TA2859
	32	36	315	85	110		105TA7053
	32	39	236	40	55		134TA6311
	33	38	265	45	110		134TA5726
	35	35	210	50	60		139TA3890
	35	35	253	55	80		108TA4483
	35	38	215	65	100		105TA7050
	35	38	333	80	175		108TA4489
	38	38	196	90	90		139TA3891
	38	38	200	45	80		105TA7257
	38	38	230	55	70		105TA7004
	38	38	260	65	190		139TA3892



REF [124TA2859](#)



REF [105TA7053](#)



REF [134TA6311](#)



REF [134TA5726](#)



REF [139TA3890](#)



REF [108TA4483](#)

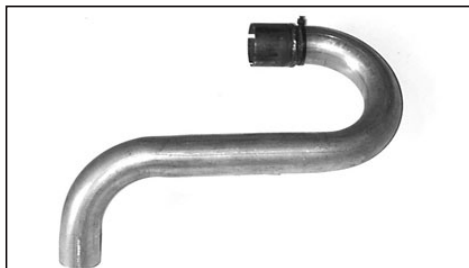

REF [105TA7050](#)

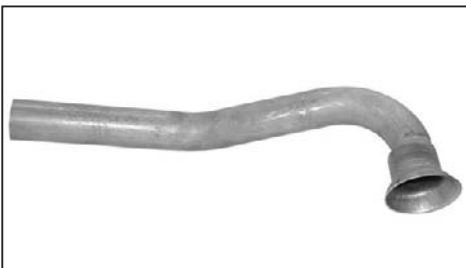

REF [108TA4489](#)



REF [139TA3891](#)



REF [105TA7257](#)



REF [105TA7004](#)



REF [139TA3892](#)

EXHAUST TUBES

For all our latest catalogue updates and company info: www.tvh.com

EXHAUST TUBES

used for: **HYSTER**

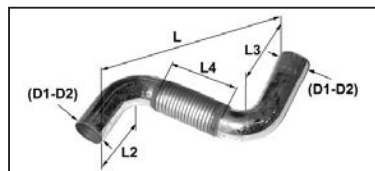

Number of bends AT-BO	Smallest outer dia. tube (mm) D1	Largest outer dia. tube (mm) D2	Dimension (mm) L	Dimension (mm) L2	Dimension (mm) L3	Dimension (mm) L4	REF
2	38	38	315	65	100		105TA7052
	38	38	385	90	110		118TA1556
	38	38	385	95	115		139TA3893
	38	38	480	100	230		139TA3894
	38	38	1130	25	170		124TA7622
	38	41	1150	30	230		139TA3895
	38	42	405	110	320		139TA3896
	38	42	1105	10	220		139TA3897
	38	42	1115	20	160		139TA3898
	38	44	140	40	40		139TA3899
	38	44	1110	35	220		134TA6344
	38	44	1120	20	130		139TA3900

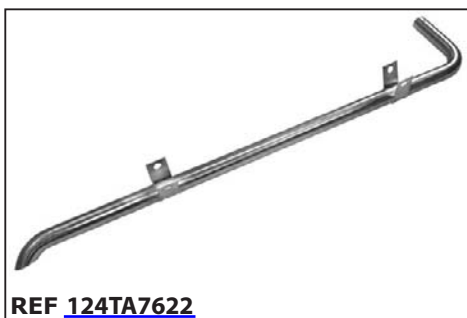

EXHAUST TUBES

For all our latest catalogue updates and company info: www.tvh.com



EXHAUST TUBES

used for: **HYSTER**

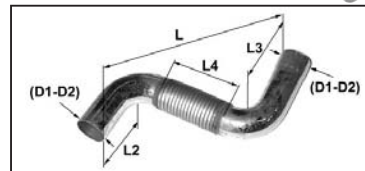

Number of bends AT-BO	Smallest outer dia. tube (mm) D1	Largest outer dia. tube (mm) D2	Dimension (mm) L	Dimension (mm) L2	Dimension (mm) L3	Dimension (mm) L4	REF
2	38	44	1180	30	255		134TA5880
	38	50	1160	20	240		139TA3901
	38	51	420	100	185		139TA3902
	38	62	337	78	174		123TA6622
	39	39	1145	15	160		105TA7171
	39	39	1260	15	400		105TA7170
	41	41	280	100	140		118TA1677
	42	51	375	225	290		139TA3903
	44	45	220	40	60		105TA7362
	45	45	89	30	45		105TA7343
	45	45	352	110	115		134TA6127
	45	45	1025	20	110		105TA7181



EXHAUST TUBES

For all our latest catalogue updates and company info: www.tvh.com

used for: **HYSTER**

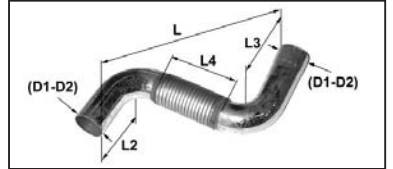

EXHAUST TUBES

Number of bends AT-BO	Smallest outer dia. tube (mm) D1	Largest outer dia. tube (mm) D2	Dimension (mm) L	Dimension (mm) L2	Dimension (mm) L3	Dimension (mm) L4	REF
2	45	45	1160	50	145		124TA7623
	45	51	400	184	330		139TA3904
	45	67	65	35	50		134TA5978
	47	49	405	60	260		134TA6170
	48	48	190	105	125		124TA7250
	48	48	425	75	80		105TA7079
	48	50	1000	40	125		108TA4380
	50	50	265	55	90		105TA7294
	50	50	290	85	140		110TA9623
	50	50	315	95	110		105TA7311
	50	50	340	20	100		139TA3905
	50	50	410	60	270		134TA5950



EXHAUST TUBES

For all our latest catalogue updates and company info: www.tvh.com



EXHAUST TUBES

used for: **HYSTER**

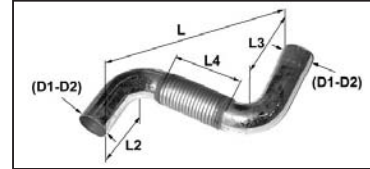

Number of bends AT-BO	Smallest outer dia. tube (mm) D1	Largest outer dia. tube (mm) D2	Dimension (mm) L	Dimension (mm) L2	Dimension (mm) L3	Dimension (mm) L4	REF
2	50	50	478	134	200		110TA9622
	50	52	265	42	242		108TA8888
	50	54	267	50	155		134TA6044
	50	55	1015	20	110		134TA6202
	50	56	403	40	200		105TA6931
	50	82	1065	25	130		105TA6926
	51	51	250	80	140		105TA7179
	51	51	280	25	220		139TA3906
	51	51	340	100	210		105TA6903
	51	51	370	202	220		134TA5938
	51	54	515	280	290		124TA2093
	51	55	205	70	110		105TA7361



EXHAUST TUBES

For all our latest catalogue updates and company info: www.tvh.com

used for: **HYSTER**

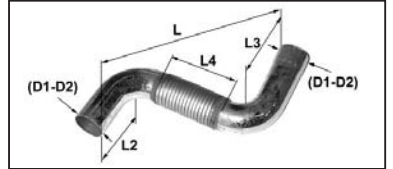

EXHAUST TUBES

Number of bends AT-BO	Smallest outer dia. tube (mm) D1	Largest outer dia. tube (mm) D2	Dimension (mm) L	Dimension (mm) L2	Dimension (mm) L3	Dimension (mm) L4	REF
2	51	55	1170	22	260		118TA1690
	62	62	345	95	220	140	139TA3907
	62	76	230	110	145		105TA6901
	63	63	230	80	85		134TA6132
	65	65	1495	50	145		123TA6623
	69	74	1850	45	225		108TA4376
	69	74	1860	80	250		139TA3908
	70	73	575	210	225		105TA6899
	70	74	1855	60	170		108TA4388
	71	77	403	90	110		134TA6356
	75	75	375	20	105		139TA3909
	75	77	635	55	80		105TA7167



EXHAUST TUBES

For all our latest catalogue updates and company info: www.tvh.com



EXHAUST TUBES

used for: **HYSTER**

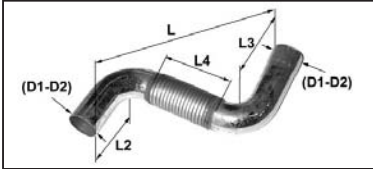

Number of bends	Smallest outer dia. tube (mm) D1	Largest outer dia. tube (mm) D2	Dimension (mm) L	Dimension (mm) L2	Dimension (mm) L3	Dimension (mm) L4	REF
2	75	80	1230	100	350		134TA5885
	76	76	530	80	420		105TA7282
	76	76	660	90	580		105TA7209
	76	88	310	75	177		118TA1548
	77	77	745	65	395		134TA5719
	100	100	380	100	120		139TA3910
	127	127	240	60	100		139TA3911
3	32	35	685	55	205		105TA7086
	35	35	345	30	130	155	105TA7405
	35	35	605	100	120		105TA7121
	35	38	195	65	65		139TA3912
	35	38	345	105	110		134TA6158



EXHAUST TUBES

For all our latest catalogue updates and company info: www.tvh.com

EXHAUST TUBES

used for: **HYSTER**

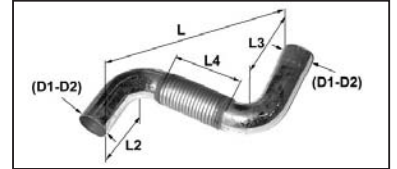

Number of bends AT-BO	Smallest outer dia. tube (mm) D1	Largest outer dia. tube (mm) D2	Dimension (mm) L	Dimension (mm) L2	Dimension (mm) L3	Dimension (mm) L4	REF
3	35	38	455	80	90		108TA4414
	35	40	420	60	90		134TA5864
	35	40	485	70	80		134TA5900
	36	38	485	70	80		105TA6907
	37	37	368	65	120		118TA1534
	37	38	340	80	80		134TA6360
	38	38	310	60	70		134TA5803
	38	38	415	75	115		110TA8604
	38	38	450	100	105		108TA4533
	38	38	465	75	90		134TA5844
	38	38	475	70	70		134TA5817
	38	38	520	60	195		134TA5974

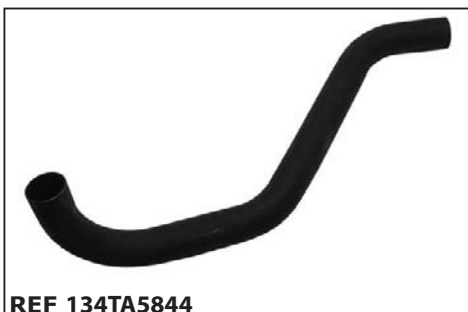
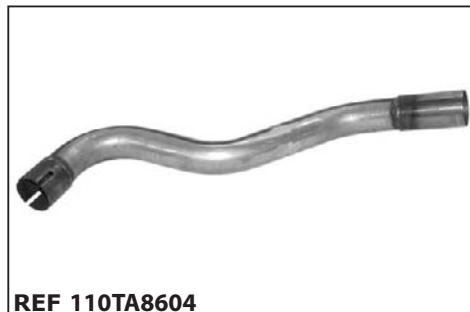

EXHAUST TUBES

For all our latest catalogue updates and company info: www.tvh.com



EXHAUST TUBES

used for: **HYSTER**

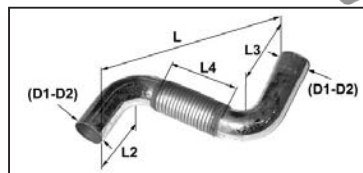

Number of bends AT-BO	Smallest outer dia. tube (mm) D1	Largest outer dia. tube (mm) D2	Dimension (mm) L	Dimension (mm) L2	Dimension (mm) L3	Dimension (mm) L4	REF
3	38	38	520	75	195		123TA6624
	38	38	650	70	120		118TA1475
	38	42	460	70	75		123TA6625
	38	42	463	65	120		118TA1523
	39	42	430	75	100		110TA8588
	39	45	340	60	85		139TA3913
	40	60	375	75	80		134TA5941
	41	41	400	90	110		139TA3914
	43	43	425	80	90	140	139TA3915
	44	44	773	146	150		118TA1533
	44	47	594	72	90		124TA7618
	44	52	1190	30	90		111TA3676



EXHAUST TUBES

For all our latest catalogue updates and company info: www.tvh.com

used for: **HYSTER**

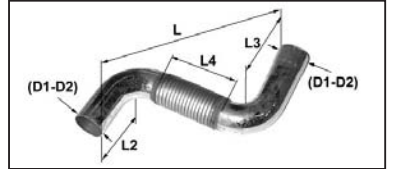

EXHAUST TUBES

Number of bends AT-BO	Smallest outer dia. tube (mm) D1	Largest outer dia. tube (mm) D2	Dimension (mm) L	Dimension (mm) L2	Dimension (mm) L3	Dimension (mm) L4	REF
3	45	45	500	120	265		105TA7145
	45	45	1075	25	185		105TA7230
	45	47	500	60	60		139TA3916
	45	47	715	40	125		105TA7288
	45	48	530	70	100		118TA1703
	50	51	470	60	135		139TA3917
	50	51	955	40	50		108TA4444
	50	54	330	60	90		134TA6265
	50	54	785	110	295		108TA4412
	50	55	625	75	160		134TA5967
	51	51	340	75	130		134TA5502
	51	51	375	75	165		124TA7620



EXHAUST TUBES

For all our latest catalogue updates and company info: www.tvh.com



EXHAUST TUBES

used for: **HYSTER**

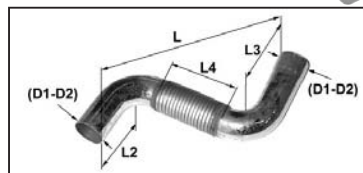

Number of bends AT-BO	Smallest outer dia. tube (mm) D1	Largest outer dia. tube (mm) D2	Dimension (mm) L	Dimension (mm) L2	Dimension (mm) L3	Dimension (mm) L4	REF
3	51	51	465	70	150		134TA6306
	51	51	535	170	175		105TA7110
	51	51	565	50	105		105TA7190
	51	54	295	65	105		105TA7012
	51	55	555	70	130		123TA6626
	55	101	510	70	270		139TA3918
	57	59	800	90	110		105TA7349
	58	58	587	66	70		110TA9610
	64	75	710	115	275		105TA7413
	73	73	1085	100	535		134TA6304
	76	76	705	95	150		105TA6971
	100	100	465	57	80		118TA1593



EXHAUST TUBES

For all our latest catalogue updates and company info: www.tvh.com

used for: **HYSTER**

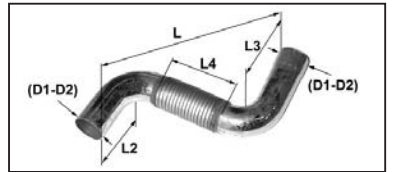

EXHAUST TUBES

Number of bends AT-BO	Smallest outer dia. tube (mm) D1	Largest outer dia. tube (mm) D2	Dimension (mm) L	Dimension (mm) L2	Dimension (mm) L3	Dimension (mm) L4	REF
4	32	32	580	65	115		105TA6900
	32	32	640	80	125		105TA6922
	33	33	1375	30	50		106TA5120
	35	35	540	85	110		134TA6244
	35	35	580	100	130		134TA6030
	35	35	605	100	135		124TA7630
	35	35	650	100	140		139TA3919
	45	45	755	75	195		124TA7619
	45	45	775	95	215		134TA5773
	49	51	565	25	115		105TA7054
	50	51	475	65	100		134TA5728
	50	56	842	102	155		108TA4456



EXHAUST TUBES

For all our latest catalogue updates and company info: www.tvh.com



EXHAUST TUBES

used for: **HYSTER**

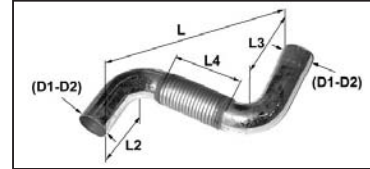

Number of bends AT-BO	Smallest outer dia. tube (mm) D1	Largest outer dia. tube (mm) D2	Dimension (mm) L	Dimension (mm) L2	Dimension (mm) L3	Dimension (mm) L4	REF
4	51	51	550	100	195		105TA7105
	51	51	780	80	125		106TA6253
	51	55	525	135	305		134TA6349
	64	64	645	65	170		105TA7002
	64	69	670	95	190		105TA7106
	102	102	370	100	240		139TA3920
5	32	32	780	55	75		105TA7051
	35	35	540	70	70		123TA6628
	35	35	695	70	160	90	139TA3921
	37	38	690	80	160		134TA5597
	49	51	1085	70	260	145	139TA3922
	51	57	755	60	150		139TA3923

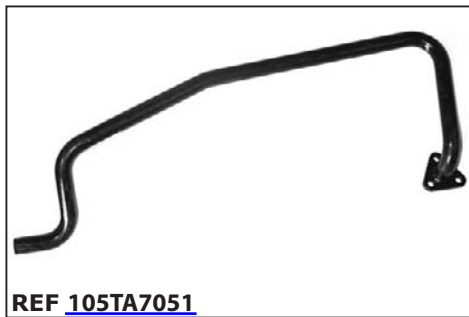

EXHAUST TUBES

For all our latest catalogue updates and company info: www.tvh.com

EXHAUST TUBES

used for: **HYSTER**

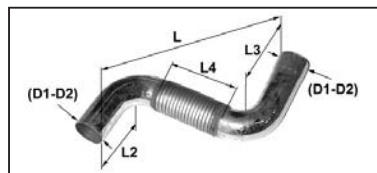

Number of bends AT-BO	Smallest outer dia. tube (mm) D1	Largest outer dia. tube (mm) D2	Dimension (mm) L	Dimension (mm) L2	Dimension (mm) L3	Dimension (mm) L4	REF
6	35	35	645	80	125		134TA5736
	50	54	847	57	90		123TA6629
	51	51	1395	70	140		105TA7177



Look up these parts via

myPS MyProductSearch

EXHAUST TUBES

For all our latest catalogue updates and company info: www.tvh.com



EXHAUST TUBES

used for: **HYUNDAI**

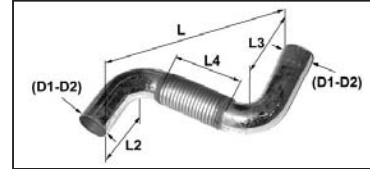

Number of bends	Smallest outer dia. tube (mm) D1	Largest outer dia. tube (mm) D2	Dimension (mm) L	Dimension (mm) L2	Dimension (mm) L3	Dimension (mm) L4	REF
0	51	51	204				139TA3924
	58	58	110				123TA6630
	64	64	400			190	134TA6256
1	43	48	340	110	240	210	123TA6634
	50	50	145	50	110		134TA6210
	63	63	640	100	610	150	134TA5956
	63	69	360	180	290	90	139TA3925
2	42	42	315	60	70	110	123TA6631
	42	42	325	75	170	75	139TA3926
	42	43	563	120	340	290	118TA1538
	42	47	365	80	230	95	123TA6632
	43	43	335	80	145	75	134TA6115

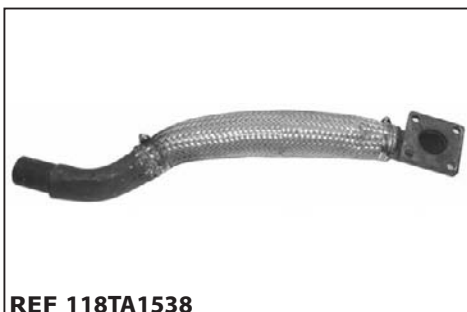

EXHAUST TUBES

For all our latest catalogue updates and company info: www.tvh.com

EXHAUST TUBES

used for: **HYUNDAI**

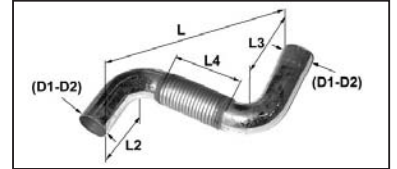

Number of bends AT-BO	Smallest outer dia. tube (mm) D1	Largest outer dia. tube (mm) D2	Dimension (mm) L	Dimension (mm) L2	Dimension (mm) L3	Dimension (mm) L4	REF
2	63	63	1300	20	140		134TA5973
	63	64	590	100	480	175	139TA3927
3	37	40	565	37	75	150	106TA6251
	43	43	445	55	145	120	124TA2866
	43	47	555	15	115		123TA6635
	50	50	575	35	140	125	134TA6081
	64	64	690	60	90	290	139TA3928
4	30	30	485	55	80		134TA6322
	50	50	695	45	85	105	124TA2860
	51	53	870	85	95	130	105TA6887



EXHAUST TUBES

For all our latest catalogue updates and company info: www.tvh.com



EXHAUST TUBES

used for: **JCB**

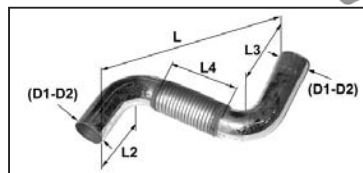

Number of bends	Smallest outer dia. tube (mm) D1	Largest outer dia. tube (mm) D2	Dimension (mm) L	Dimension (mm) L2	Dimension (mm) L3	Dimension (mm) L4	REF
0	42	42	129			87	139TA3929
	48	48	186			125	134TA5934
	127	131	128				139TA3930
1	44	48	170	80	90		139TA3931
	44	48	193	125	137		134TA5872
	44	49	165	102	117		134TA5869
	49	56	1065	25	1020		134TA5969
	50	55	502	270	350		134TA5788
	51	51	275	15	250		134TA5785
	59	61	1200	70	1160		139TA3932
	64	67	255	30	240	140	134TA5700
2	26	29	500	180	195		124TA7614

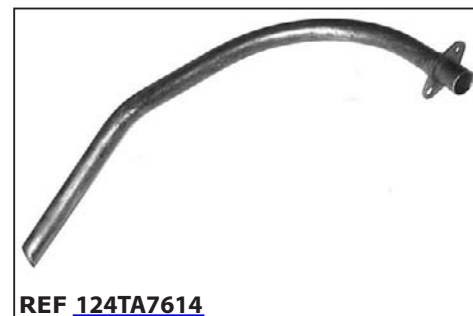

EXHAUST TUBES

For all our latest catalogue updates and company info: www.tvh.com

EXHAUST TUBES

used for: **JCB**

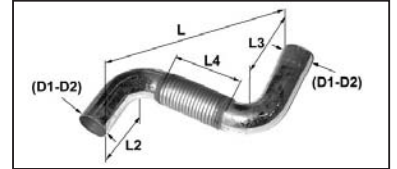

Number of bends AT-BO	Smallest outer dia. tube (mm) D1	Largest outer dia. tube (mm) D2	Dimension (mm) L	Dimension (mm) L2	Dimension (mm) L3	Dimension (mm) L4	REF
2	44	44	240	50	75		139TA3933
	45	45	360	60	110		134TA6161
	45	45	470	55	130		134TA5707
	45	48	650	140	250		139TA3934
	50	55	990	30	540		139TA3935
	51	51	350	65	170		134TA5966
	64	68	736	210	340		134TA5876
	65	65	310	70	135		134TA5866
3	51	55	605	200	225		134TA5937
	64	68	605	195	230		134TA6102
4	45	48	315	70	185		134TA6088



EXHAUST TUBES

For all our latest catalogue updates and company info: www.tvh.com



EXHAUST TUBES

used for: **JLG**

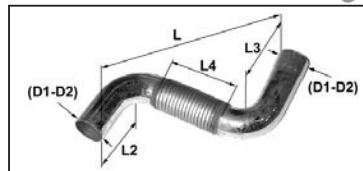

Number of bends AT-BO	Smallest outer dia. tube (mm) D1	Largest outer dia. tube (mm) D2	Dimension (mm) L	Dimension (mm) L2	Dimension (mm) L3	Dimension (mm) L4	REF
0	64	64	255				139TA3936
1	38	38	140	15	125		139TA3937
	45	48	197	90	145		134TA5741
	88	88	190	25	140		134TA6043
	88	91	272	60	230		126TA4810
2	48	51	745	190	600		134TA5819
3	39	39	405	95	185		134TA5574



EXHAUST TUBES

For all our latest catalogue updates and company info: www.tvh.com

EXHAUST TUBES

used for: **JUNGHEINRICH-STEINBOCK**

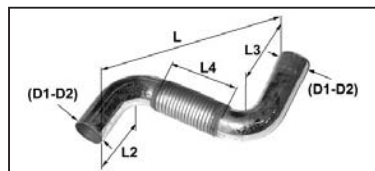

Number of bends AT-BO	Smallest outer dia. tube (mm) D1	Largest outer dia. tube (mm) D2	Dimension (mm) L	Dimension (mm) L2	Dimension (mm) L3	Dimension (mm) L4	REF
0	42	45	315			215	118TA1404
	51	51	280			165	118TA1394
	51	51	525			225	118TA1459
	51	52	327			186	124TA7231
	54	54	86				124TA1047
	57	57	88				108TA8892
	61	61	66				124TA1070
	76	88	180				118TA1541
1	35	35	227	95	140	85	134TA5763
	35	35	252	60	195		118TA1466
	35	35	627	120	600	140	105TA7419
	35	38	315	80	275		134TA5826



REF [118TA1404](#)

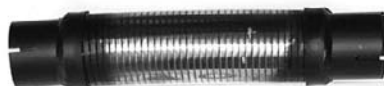

REF [118TA1394](#)



REF [118TA1459](#)



REF [124TA7231](#)



REF [124TA1047](#)



REF [108TA8892](#)



REF [124TA1070](#)



REF [118TA1541](#)



REF [134TA5763](#)



REF [118TA1466](#)



REF [105TA7419](#)



REF [134TA5826](#)

EXHAUST TUBES

For all our latest catalogue updates and company info: www.tvh.com



used for: **JUNGHEINRICH-STEINBOCK**

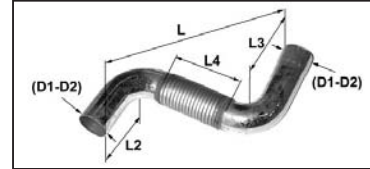

EXHAUST TUBES

Number of bends AT-BO	Smallest outer dia. tube (mm) D1	Largest outer dia. tube (mm) D2	Dimension (mm) L	Dimension (mm) L2	Dimension (mm) L3	Dimension (mm) L4	REF
1	38	38	185	65	125		105TA6938
	38	38	200	83	130		123TA6637
	38	49	345	140	240	155	134TA6138
	41	46	148	100	110		118TA1485
	41	46	180	90	150		139TA3938
	41	76	1060	125	1050		108TA4303
	41	76	1120	125	1120		104TA5963
	43	43	200	110	135		110TA8594
	43	52	915	52	890		118TA1517
	43	52	1070	60	1040		108TA4379
	44	44	280	54	270		134TA5656
	44	50	382	75	340	180	108TA4491



EXHAUST TUBES

For all our latest catalogue updates and company info: www.tvh.com

EXHAUST TUBES

used for: **JUNGHEINRICH-STEINBOCK**

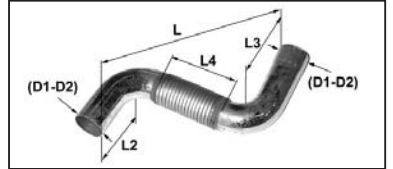

Number of bends AT-BO	Smallest outer dia. tube (mm) D1	Largest outer dia. tube (mm) D2	Dimension (mm) L	Dimension (mm) L2	Dimension (mm) L3	Dimension (mm) L4	REF
1	44	50	510	45	48	327	110TA9612
	44	50	1070	50	1035		124TA1048
	44	51	480	63	460	275	134TA6017
	45	48	260	70	280		139TA3939
	45	48	320	130	265		139TA3940
	45	48	330	180	310	160	124TA1063
	45	48	340	170	320	170	139TA3941
	45	49	156	70	135		123TA6639
	45	51	535	45	515	368	105TA7451
	46	49	295	145	165		134TA5780
	48	60	460	200	395	180	134TA5919
	50	50	215	5	200		123TA6640



EXHAUST TUBES

For all our latest catalogue updates and company info: www.tvh.com



used for: **JUNGHEINRICH-STEINBOCK**

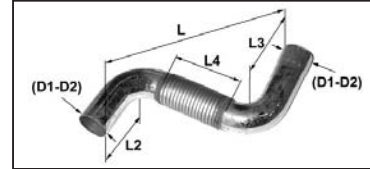

EXHAUST TUBES

Number of bends AT-BO	Smallest outer dia. tube (mm) D1	Largest outer dia. tube (mm) D2	Dimension (mm) L	Dimension (mm) L2	Dimension (mm) L3	Dimension (mm) L4	REF
1	50	58	1135	30	1100		134TA5879
	51	51	755	75	700		134TA5750
	51	57	463	200	395		108TA8884
	54	56	200	55	155		134TA5846
	55	60	260	20	240	155	134TA6036
	56	56	115	30	95		105TA6943
	56	64	460	220	470		134TA5841
	57	61	270	37	280	100	139TA3942
	57	63	480	260	370	180	134TA5962
	58	58	130	40	90		124TA2867
	58	58	285	100	205		134TA5975
	58	61	232	90	160		123TA6641



EXHAUST TUBES

For all our latest catalogue updates and company info: www.tvh.com

EXHAUST TUBES

used for: **JUNGHEINRICH-STEINBOCK**

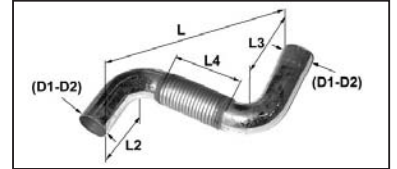

Number of bends AT-BO	Smallest outer dia. tube (mm) D1	Largest outer dia. tube (mm) D2	Dimension (mm) L	Dimension (mm) L2	Dimension (mm) L3	Dimension (mm) L4	REF
1	58	61	630	40	590	450	134TA6042
	58	62	224	15	210		134TA5679
	58	63	285	45	285	115	139TA3943
	60	66	765	50	720		123TA6643
	63	63	200	100	125		118TA1478
	63	67	225	115	160		139TA3944
	64	64	142	60	115		134TA5706
	64	67	79	40	40		139TA3945
	67	67	765	65	760	630	123TA6644
	76	76	258	150	170		134TA6235
	106	106	105	50	55		123TA6645
	110	115	780	40	730	660	134TA6327



REF [134TA6042](#)



REF [134TA5679](#)



REF [139TA3943](#)



REF [123TA6643](#)



REF [118TA1478](#)



REF [139TA3944](#)



REF [134TA5706](#)



REF [139TA3945](#)

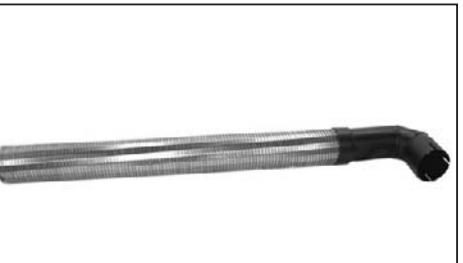

REF [123TA6644](#)



REF [134TA6235](#)



REF [123TA6645](#)



REF [134TA6327](#)

EXHAUST TUBES

For all our latest catalogue updates and company info: www.tvh.com



used for: **JUNGHEINRICH-STEINBOCK**

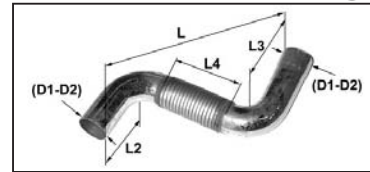

EXHAUST TUBES

Number of bends AT-BO	Smallest outer dia. tube (mm) D1	Largest outer dia. tube (mm) D2	Dimension (mm) L	Dimension (mm) L2	Dimension (mm) L3	Dimension (mm) L4	REF
2	29	29	380	80	170		106TA5121
	35	38	310	75	175		139TA3946
	35	38	515	100	130		108TA4410
	35	38	570	115	145		139TA3947
	35	38	645	115	160		118TA1562
	35	39	650	105	170		123TA6646
	38	38	345	60	175		105TA6924
	38	38	385	90	110		118TA1558
	38	38	470	75	255		105TA6984
	38	38	665	100	190		118TA1681
	38	48	380	70	110	160	123TA6647
	38	49	400	60	90		134TA5731

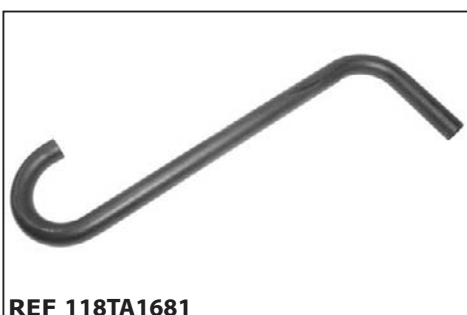

EXHAUST TUBES

For all our latest catalogue updates and company info: www.tvh.com

EXHAUST TUBES

used for: **JUNGHEINRICH-STEINBOCK**

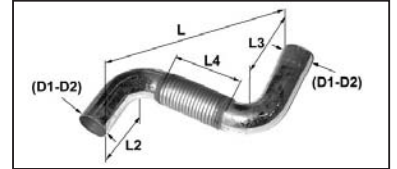

Number of bends AT-BO	Smallest outer dia. tube (mm) D1	Largest outer dia. tube (mm) D2	Dimension (mm) L	Dimension (mm) L2	Dimension (mm) L3	Dimension (mm) L4	REF
2	42	42	222	65	100		108TA4501
	42	42	615	65	360		124TA7632
	42	45	310	63	200		118TA1633
	42	45	390	50	300		134TA6364
	43	45	400	15	230		139TA3948
	43	47	475	100	155	175	110TA8595
	44	45	545	50	200	110	134TA6275
	45	45	330	90	280	145	118TA1674
	45	45	365	30	198		118TA1666
	45	45	555	95	370	200	118TA1544
	45	45	560	95	345	230	118TA1654
	45	45	615	70	275	125	134TA5926



EXHAUST TUBES

For all our latest catalogue updates and company info: www.tvh.com



EXHAUST TUBES

used for: **JUNGHEINRICH-STEINBOCK**

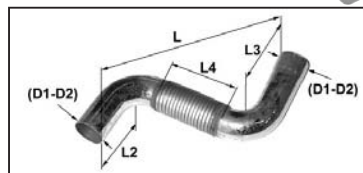

Number of bends	Smallest outer dia. tube (mm)	Largest outer dia. tube (mm)	Dimension (mm)	Dimension (mm)	Dimension (mm)	Dimension (mm)	REF
AT-BO	D1	D2	L	L2	L3	L4	
2	45	47	335	130	235		118TA1455
	45	47	475	125	305	130	134TA6143
	45	48	450	70	175	52	134TA6292
	47	49	780	80	610	140	123TA6649
	48	52	315	45	60		134TA6134
	48	65	380	85	135		108TA8270
	49	53	555	160	220	85	134TA6061
	50	55	730	50	95		134TA6318
	50	60	885	90	700	125	124TA5151
	51	51	340	100	210		105TA7354
	51	58	630	130	275		123TA6650
	57	57	260	25	110		123TA6651



REF [118TA1455](#)



REF [134TA6143](#)



REF [134TA6292](#)



REF [123TA6649](#)



REF [134TA6134](#)



REF [108TA8270](#)



REF [134TA6061](#)



REF [134TA6318](#)



REF [124TA5151](#)



REF [105TA7354](#)



REF [123TA6650](#)



REF [123TA6651](#)

EXHAUST TUBES

For all our latest catalogue updates and company info: www.tvh.com

EXHAUST TUBES

used for: **JUNGHEINRICH-STEINBOCK**

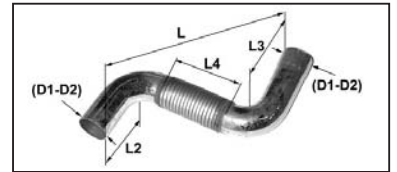

Number of bends AT-BO	Smallest outer dia. tube (mm) D1	Largest outer dia. tube (mm) D2	Dimension (mm) L	Dimension (mm) L2	Dimension (mm) L3	Dimension (mm) L4	REF
2	57	57	310	25	100		123TA6652
	60	60	410	75	195		134TA5878
	63	63	460	70	170		123TA6653
	63	64	157	71	81		108TA4402
	63	66	685	60	160	345	110TA9625
	63	67	700	60	165	465	118TA1383
	76	76	730	260	410		139TA3949
3	34	35	240	10	43		124TA2869
	34	36	395	95	165	138	118TA1701
	34	40	267	5	50		124TA2858
	35	35	175	50	90		124TA1072
	35	35	412	80	110		108TA4472

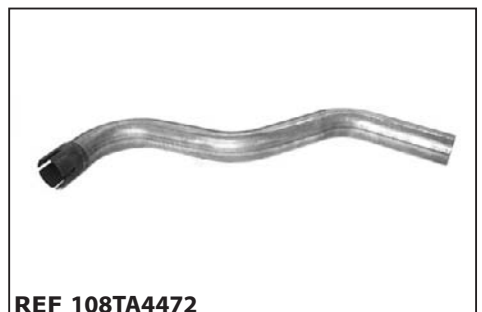

EXHAUST TUBES

For all our latest catalogue updates and company info: www.tvh.com



used for: **JUNGHEINRICH-STEINBOCK**

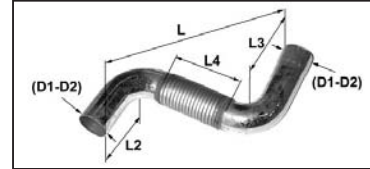

EXHAUST TUBES

Number of bends AT-BO	Smallest outer dia. tube (mm) D1	Largest outer dia. tube (mm) D2	Dimension (mm) L	Dimension (mm) L2	Dimension (mm) L3	Dimension (mm) L4	REF
3	35	35	605	100	120		105TA7123
	35	38	428	85	135		139TA3950
	35	40	485	70	80		134TA5902
	35	48	580	70	113		118TA1513
	38	38	415	75	115		110TA8606
	38	38	450	100	105		108TA4535
	38	38	480	55	105		105TA7133
	38	38	650	70	120		108TA4460
	38	45	575	80	240	140	134TA6280
	39	42	285	68	110		139TA3951
	39	42	430	75	100		110TA8590
	40	48	565	66	95		124TA1052



EXHAUST TUBES

For all our latest catalogue updates and company info: www.tvh.com

EXHAUST TUBES

used for: **JUNGHEINRICH-STEINBOCK**

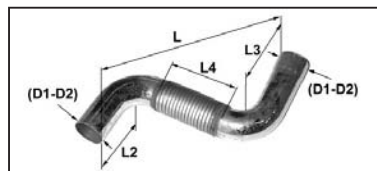

Number of bends AT-BO	Smallest outer dia. tube (mm) D1	Largest outer dia. tube (mm) D2	Dimension (mm) L	Dimension (mm) L2	Dimension (mm) L3	Dimension (mm) L4	REF
3	41	44	505	45	240	140	139TA3952
	41	45	360	73	150	150	118TA1488
	41	47	415	60	100		124TA1116
	42	42	480	155	230	85	124TA2078
	42	44	495	70	310	225	118TA1481
	42	44	500	50	260	210	134TA5859
	42	49	330	27	75		118TA1577
	43	43	390	45	165	80	105TA7194
	43	43	425	80	90	140	118TA1421
	44	44	475	85	380	190	105TA6883
	44	44	605	20	340	230	106TA6248
	44	44	620	50	330	230	118TA1490



REF [139TA3952](#)



REF [118TA1488](#)

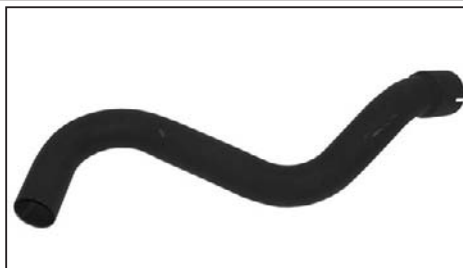

REF [124TA1116](#)



REF [124TA2078](#)



REF [118TA1481](#)



REF [134TA5859](#)



REF [118TA1577](#)

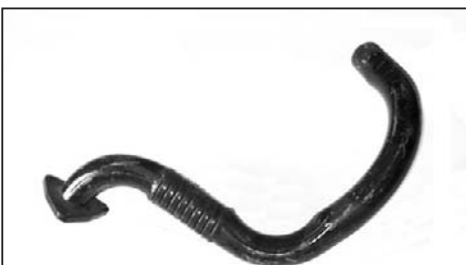

REF [105TA7194](#)



REF [118TA1421](#)



REF [105TA6883](#)

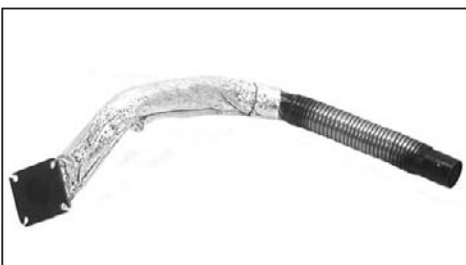

REF [106TA6248](#)



REF [118TA1490](#)

EXHAUST TUBES

For all our latest catalogue updates and company info: www.tvh.com



used for: **JUNGHEINRICH-STEINBOCK**

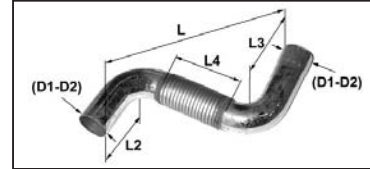

EXHAUST TUBES

Number of bends AT-BO	Smallest outer dia. tube (mm) D1	Largest outer dia. tube (mm) D2	Dimension (mm) L	Dimension (mm) L2	Dimension (mm) L3	Dimension (mm) L4	REF
3	45	45	590	45	275	135	134TA6334
	45	45	640	75	295	125	134TA6278
	45	48	310	15	60		134TA5857
	45	48	340	60	105		134TA5931
	45	48	705	150	205	115	134TA5771
	45	65	595	20	130		124TA2857
	47	47	525	115	115		118TA1462
	47	48	510	90	100		123TA6656
	48	49	615	155	255		134TA5777
	48	53	675	60	205		124TA1057
	56	106	1365	615	990	490	123TA6657
	57	60	620	70	195		139TA3953



EXHAUST TUBES

For all our latest catalogue updates and company info: www.tvh.com

EXHAUST TUBES

used for: **JUNGHEINRICH-STEINBOCK**

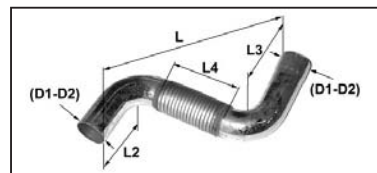

Number of bends AT-BO	Smallest outer dia. tube (mm) D1	Largest outer dia. tube (mm) D2	Dimension (mm) L	Dimension (mm) L2	Dimension (mm) L3	Dimension (mm) L4	REF
3	57	61	792	85	290	140	139TA3954
	58	62	450	25	75		134TA5850
	62	62	540	100	140		139TA3955
	64	67	845	180	720	572	118TA1585
	65	64	588	130	200		139TA3956
	65	68	785	188	640	532	108TA8889
4	35	35	605	105	140		105TA7271
	35	35	705	100	130		105TA7260
	35	42	600	40	95	125	105TA7153
	38	38	460	30	125		106TA7362
	38	38	460	30	155		106TA7367
	38	38	505	30	160		105TA7077



EXHAUST TUBES

For all our latest catalogue updates and company info: www.tvh.com



EXHAUST TUBES

used for: **JUNGHEINRICH-STEINBOCK**

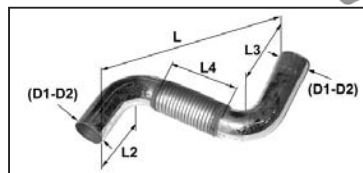

Number of bends	Smallest outer dia. tube (mm) D1	Largest outer dia. tube (mm) D2	Dimension (mm) L	Dimension (mm) L2	Dimension (mm) L3	Dimension (mm) L4	REF
4	38	38	675	100	245		139TA3957
	47	48	670	60	80		139TA3958
	47	48	765	62	93	157	106TA5026
	48	48	500	65	80		123TA6658
5	33	33	515	60	115	155	105TA7138
	35	35	605	70	70		106TA7347
	35	35	680	20	90		139TA3959
	40	42	680	120	273	150	134TA5685
	44	49	1345	40	50		139TA3960
	50	50	680	53	105		105TA7430
	50	55	553	55	120		123TA6660
6	35	35	645	80	125		134TA5738

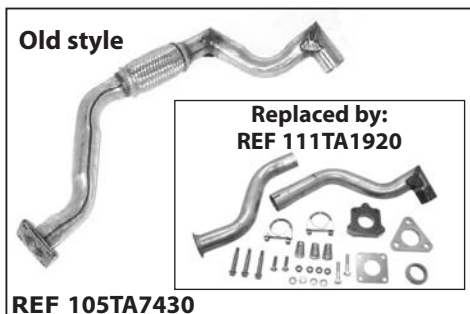

EXHAUST TUBES

For all our latest catalogue updates and company info: www.tvh.com

EXHAUST TUBES

used for: **JUNGHEINRICH-STEINBOCK**

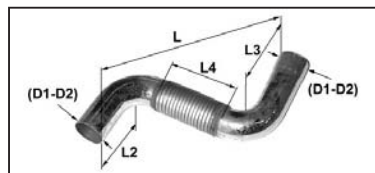

Number of bends AT-BO	Smallest outer dia. tube (mm) D1	Largest outer dia. tube (mm) D2	Dimension (mm) L	Dimension (mm) L2	Dimension (mm) L3	Dimension (mm) L4	REF
6	39	58	910	100	150		139TA3961
7	35	35	780	25	70		105TA6987
	50	58	580	90	220		134TA6117



REF [139TA3961](#)



REF [105TA6987](#)



REF [134TA6117](#)

Look up these parts via

EXHAUST TUBES

For all our latest catalogue updates and company info: www.tvh.com



EXHAUST TUBES

used for: **KALMAR**

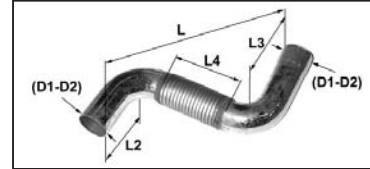

Number of bends AT-BO	Smallest outer dia. tube (mm) D1	Largest outer dia. tube (mm) D2	Dimension (mm) L	Dimension (mm) L2	Dimension (mm) L3	Dimension (mm) L4	REF
0	76	76	1042				124TA1060
	100	100	485			435	134TA6358
	105	105	1210				110TA9615
1	60	60	810	40	770		139TA3962
	60	61	92	18	76		139TA3963
	70	70	560	57	515		118TA1668
	76	76	190	120	120		134TA6254
	76	76	790	50	750		105TA7174
	76	76	790	60	740		134TA6234
	76	89	100	45	90		134TA6217
	76	89	100	80	80		134TA5852
	77	45	1770	45	1730		134TA5891

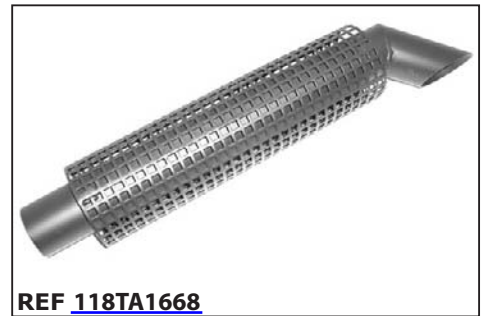
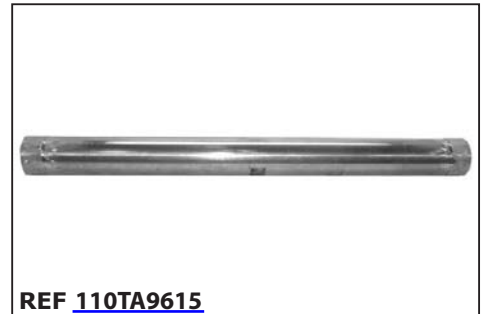

EXHAUST TUBES

For all our latest catalogue updates and company info: www.tvh.com

EXHAUST TUBES

used for: **KALMAR**

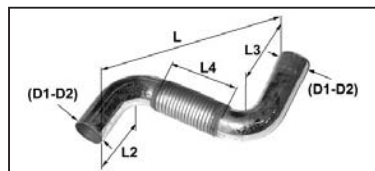

Number of bends AT-BO	Smallest outer dia. tube (mm) D1	Largest outer dia. tube (mm) D2	Dimension (mm) L	Dimension (mm) L2	Dimension (mm) L3	Dimension (mm) L4	REF
1	77	77	940	55	895		134TA5816
	77	89	165	125	135		139TA3964
	78	88	300	120	230		123TA6661
	78	110	220	130	140		134TA6109
	89	89	215	105	150		123TA6662
	89	94	69	15	50		134TA6281
	90	90	900	80	835		123TA6663
	100	100	310	205	205		139TA3965
	100	100	2170	40	2130		134TA6064
	102	102	1107	40	1050		139TA3966
	102	103	1982	140	1966		108TA4515
	102	114	200	116	125		118TA1704

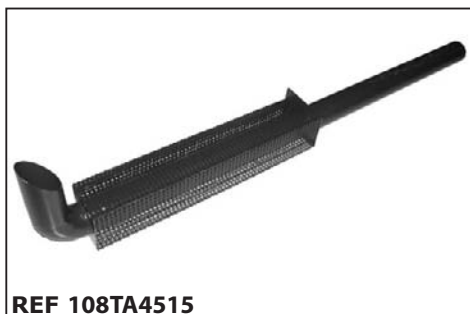

EXHAUST TUBES

For all our latest catalogue updates and company info: www.tvh.com



EXHAUST TUBES

used for: **KALMAR**

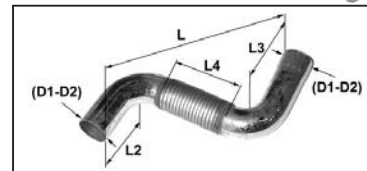

Number of bends AT-BO	Smallest outer dia. tube (mm) D1	Largest outer dia. tube (mm) D2	Dimension (mm) L	Dimension (mm) L2	Dimension (mm) L3	Dimension (mm) L4	REF
1	114	114	1875	35	1810		124TA1077
	114	115	1185	100	1160		134TA6310
	115	115	1595	160	1530		139TA3967
	115	150	2020	20	1990		134TA5949
	116	116	960	65	890		118TA1532
2	26	29	500	180	195		139TA3968
	29	29	380	80	170		123TA6664
	60	60	325	15	140		134TA6073
	60	60	665	260	260		118TA1613
	75	89	280	110	170		134TA6206
	75	89	280	120	180		134TA6147
	76	80	545	70	285		134TA6028

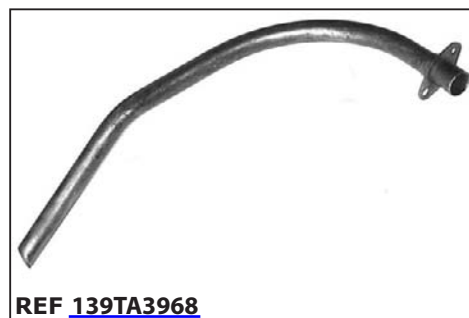

EXHAUST TUBES

For all our latest catalogue updates and company info: www.tvh.com

used for: **KALMAR**

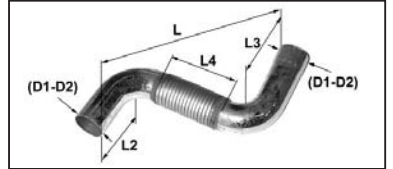

EXHAUST TUBES

Number of bends AT-BO	Smallest outer dia. tube (mm) D1	Largest outer dia. tube (mm) D2	Dimension (mm) L	Dimension (mm) L2	Dimension (mm) L3	Dimension (mm) L4	REF
2	77	90	250	70	95		124TA1058
	78	103	265	60	70		124TA1061
	88	102	1830	160	950		139TA3969
	89	89	240	60	70		134TA5867
	89	89	250	100	100		134TA6011
	89	95	325	70	210		134TA6282
	90	95	430	80	120		134TA6182
	95	102	150	10	45		139TA3970
	100	100	285	60	90		108TA4396
	100	102	460	100	160		139TA3971
	102	107	370	135	180		139TA3972
	102	114	2310	125	865		104TA5983



EXHAUST TUBES

For all our latest catalogue updates and company info: www.tvh.com



EXHAUST TUBES

used for: **KALMAR**

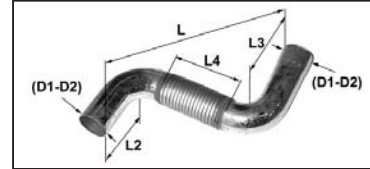

Number of bends	Smallest outer dia. tube (mm) D1	Largest outer dia. tube (mm) D2	Dimension (mm) L	Dimension (mm) L2	Dimension (mm) L3	Dimension (mm) L4	REF
2	102	116	1980	400	1650		139TA3973
	103	103	610	210	320		134TA6276
	115	121	866	140	650		134TA6192
3	54	54	1060	65	150		134TA6329
	60	60	1340	25	105		134TA5831
	60	90	320	50	100		134TA5761
	63	90	330	40	80		124TA2079
	90	96	1870	250	390		139TA3974
5	62	88	775	65	95		134TA5622
	68	89	705	45	90		108TA4528



EXHAUST TUBES

For all our latest catalogue updates and company info: www.tvh.com

used for: **KOMATSU**

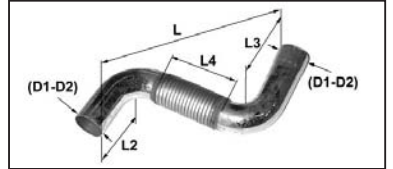

EXHAUST TUBES

Number of bends AT-BO	Smallest outer dia. tube (mm) D1	Largest outer dia. tube (mm) D2	Dimension (mm) L	Dimension (mm) L2	Dimension (mm) L3	Dimension (mm) L4	REF
0	34	34	170			107	108TA4481
	34	38	99				111TA1901
	42	45	315			215	124TA2065
	46	46	270				134TA6075
	49	49	780				134TA6129
	51	51	280			165	134TA5518
	51	52	327			186	134TA5668
	53	53	190				105TA7450
	58	58	110				123TA6665
1	34	34	251	65	190		108TA4480
	35	35	252	60	195		108TA4395
	38	38	185	65	125		108TA4420



REF [108TA4481](#)



REF [111TA1901](#)



REF [124TA2065](#)



REF [134TA6075](#)



REF [134TA6129](#)

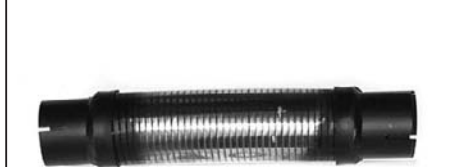

REF [134TA5518](#)

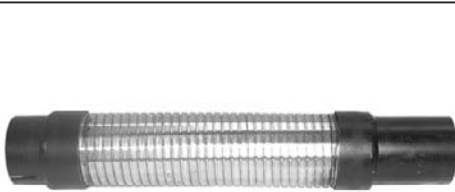

REF [134TA5668](#)



REF [105TA7450](#)



REF [123TA6665](#)

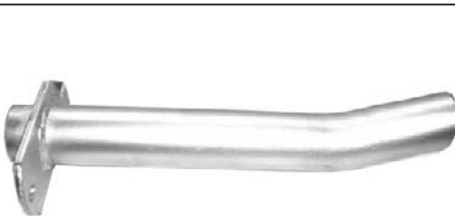

REF [108TA4480](#)



REF [108TA4395](#)



REF [108TA4420](#)

EXHAUST TUBES

For all our latest catalogue updates and company info: www.tvh.com



EXHAUST TUBES

used for: **KOMATSU**

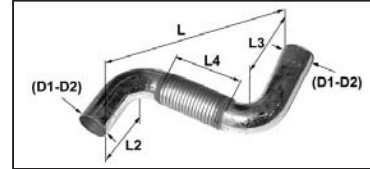

Number of bends AT-BO	Smallest outer dia. tube (mm) D1	Largest outer dia. tube (mm) D2	Dimension (mm) L	Dimension (mm) L2	Dimension (mm) L3	Dimension (mm) L4	REF
1	38	38	200	83	130		123TA6666
	38	64	870	90	800		134TA5861
	39	43	190	105	130		134TA6340
	41	46	148	100	110		108TA4496
	41	76	1120	125	1120		118TA1498
	42	42	328	75	255	140	134TA5613
	43	43	200	110	135		105TA7206
	43	43	490	260	385		105TA7280
	43	46	615	245	395	250	118TA1695
	43	47	315	80	280		110TA8603
	43	48	225	120	155		134TA5998
	44	44	280	54	270		118TA1563

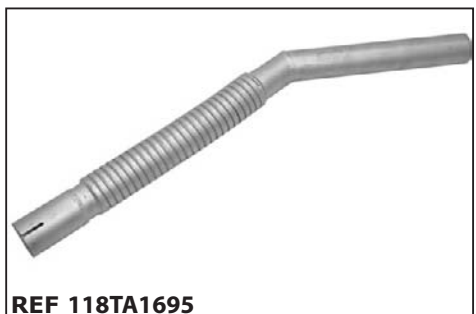
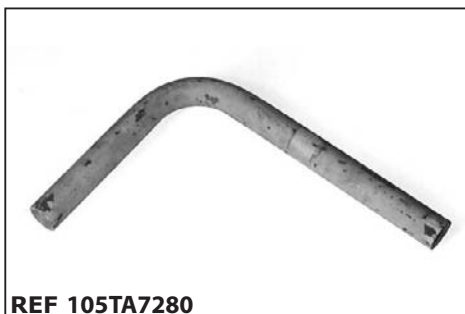

EXHAUST TUBES

For all our latest catalogue updates and company info: www.tvh.com

used for: **KOMATSU**

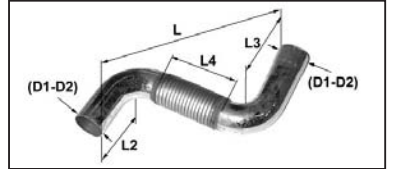

EXHAUST TUBES

Number of bends AT-BO	Smallest outer dia. tube (mm) D1	Largest outer dia. tube (mm) D2	Dimension (mm) L	Dimension (mm) L2	Dimension (mm) L3	Dimension (mm) L4	REF
1	44	49	926	80	900		118TA1476
	44	50	382	75	340	180	108TA4490
	44	50	1070	50	1035		123TA6667
	45	48	1620	45	1600		118TA1501
	45	55	784	170	620	300	123TA6668
	45	57	605	105	560	350	105TA7278
	45	57	890	65	880	640	105TA7320
	48	50	215	80	175		118TA1407
	50	50	153	100	100		134TA6260
	50	50	155	125	310	160	134TA5953
	50	50	215	5	200		123TA6669
	50	54	200	75	165		118TA1400



REF [118TA1476](#)

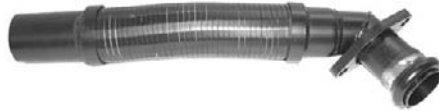

REF [108TA4490](#)



REF [123TA6667](#)



REF [118TA1501](#)



REF [123TA6668](#)



REF [105TA7278](#)



REF [105TA7320](#)



REF [118TA1407](#)



REF [134TA6260](#)

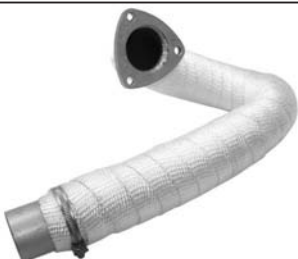

REF [134TA5953](#)



REF [123TA6669](#)



REF [118TA1400](#)

EXHAUST TUBES

For all our latest catalogue updates and company info: www.tvh.com



EXHAUST TUBES

used for: **KOMATSU**

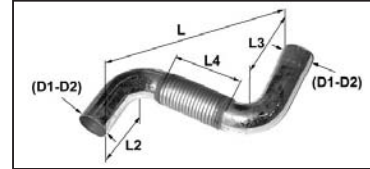

Number of bends AT-BO	Smallest outer dia. tube (mm) D1	Largest outer dia. tube (mm) D2	Dimension (mm) L	Dimension (mm) L2	Dimension (mm) L3	Dimension (mm) L4	REF
1	50	55	840	90	800		124TA1074
	50	55	845	75	820		118TA1423
	51	51	755	75	700		134TA5749
	51	56	975	400	600		139TA3975
	55	55	1405	40	138		134TA5758
	58	58	130	40	90		134TA5697
	58	61	630	40	590	450	134TA6041
	58	62	224	15	210		123TA6670
	60	60	225	80	150		134TA6005
	64	67	79	40	40		139TA3976
	76	76	780	140	700	305	139TA3977
	90	94	1080	295	795	385	134TA5883



EXHAUST TUBES

For all our latest catalogue updates and company info: www.tvh.com

used for: **KOMATSU**

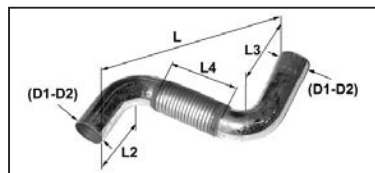

EXHAUST TUBES

Number of bends AT-BO	Smallest outer dia. tube (mm) D1	Largest outer dia. tube (mm) D2	Dimension (mm) L	Dimension (mm) L2	Dimension (mm) L3	Dimension (mm) L4	REF
1	110	115	780	40	730	660	134TA6326
2	34	37	270	95	120		105TA7297
	38	38	470	75	255		108TA4421
	38	38	665	100	190		124TA2072
	38	43	410	150	360	150	118TA1524
	38	49	400	60	90		134TA5730
	40	40	220	70	135		105TA7371
	41	48	420	80	85	140	118TA1618
	42	42	222	65	100		108TA4500
	42	42	615	65	360		139TA3978
	42	45	310	63	200		134TA5667
	42	46	203	66	80		108TA4384

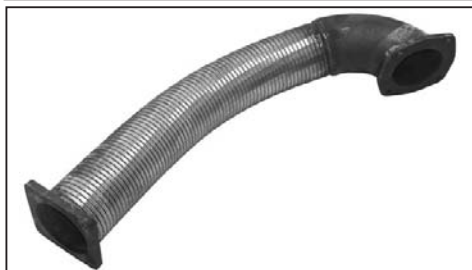

REF [134TA6326](#)



REF [105TA7297](#)



REF [108TA4421](#)



REF [124TA2072](#)

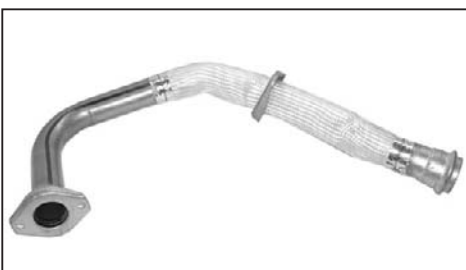

REF [118TA1524](#)



REF [134TA5730](#)



REF [105TA7371](#)

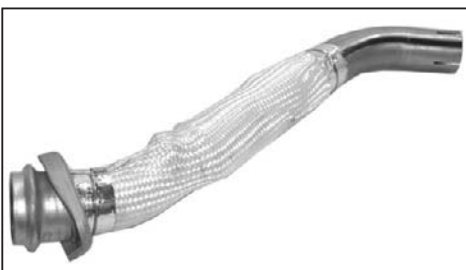

REF [118TA1618](#)



REF [108TA4500](#)



REF [139TA3978](#)



REF [134TA5667](#)



REF [108TA4384](#)

EXHAUST TUBES

For all our latest catalogue updates and company info: www.tvh.com



EXHAUST TUBES

used for: **KOMATSU**

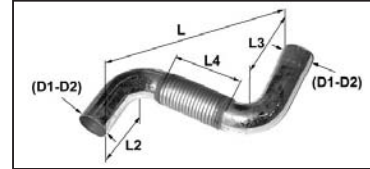

Number of bends AT-BO	Smallest outer dia. tube (mm) D1	Largest outer dia. tube (mm) D2	Dimension (mm) L	Dimension (mm) L2	Dimension (mm) L3	Dimension (mm) L4	REF
2	42	47	370	60	70	210	134TA6079
	43	43	310	70	110		105TA7391
	43	43	327	55	240		118TA1656
	43	44	280	70	85		118TA1508
	43	45	400	15	230		139TA3979
	43	46	250	60	200		134TA5924
	43	47	255	65	85		134TA6089
	43	47	475	100	155	175	134TA5561
	43	48	280	80	85		134TA5845
	43	51	300	60	100	135	105TA7347
	44	46	390	150	180	240	134TA6228
	44	51	500	70	125		139TA3980



EXHAUST TUBES

For all our latest catalogue updates and company info: www.tvh.com

used for: **KOMATSU**

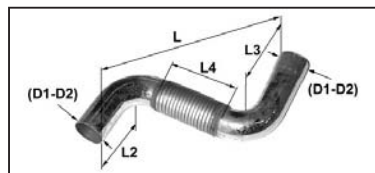

EXHAUST TUBES

Number of bends AT-BO	Smallest outer dia. tube (mm) D1	Largest outer dia. tube (mm) D2	Dimension (mm) L	Dimension (mm) L2	Dimension (mm) L3	Dimension (mm) L4	REF
2	44	58	825	40	745	390	105TA7245
	45	45	365	30	198		118TA1665
	45	45	555	95	370	200	118TA1543
	45	47	335	130	235		134TA5594
	45	50	800	120	265	110	105TA7124
	45	54	1010	90	105	75	105TA7242
	46	46	400	140	175	225	134TA5923
	47	50	440	90	250		134TA5800
	49	51	420	150	255		105TA7229
	49	51	655	55	395	290	134TA5999
	49	56	260	35	50		134TA6257
	50	50	390	80	290		134TA5781



EXHAUST TUBES

For all our latest catalogue updates and company info: www.tvh.com



EXHAUST TUBES

used for: **KOMATSU**

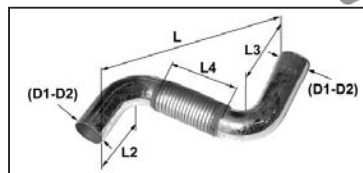

Number of bends	Smallest outer dia. tube (mm)	Largest outer dia. tube (mm)	Dimension (mm)	Dimension (mm)	Dimension (mm)	Dimension (mm)	REF
AT-BO	D1	D2	L	L2	L3	L4	
2	50	51	320	35	80		134TA6144
	50	51	595	70	400	285	139TA3981
	50	55	480	50	415	210	134TA5752
	50	55	730	50	95		134TA6317
	51	51	645	55	400	285	124TA1053
	51	53	590	60	405	200	134TA5713
	51	55	445	45	120		123TA6671
	51	55	685	60	410	210	123TA6672
	54	76	350	45	125	220	139TA3982
	63	63	460	70	170		123TA6673
	63	67	700	60	165	465	108TA4422
3	34	34	575	80	175		105TA6933



REF [134TA6144](#)



REF [139TA3981](#)



REF [134TA5752](#)



REF [134TA6317](#)



REF [124TA1053](#)



REF [134TA5713](#)

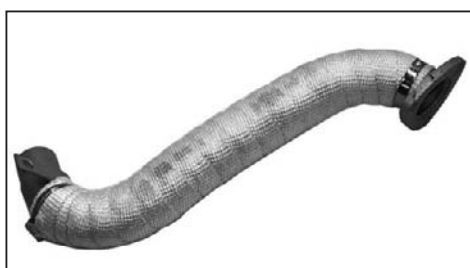

REF [123TA6671](#)



REF [123TA6672](#)



REF [139TA3982](#)



REF [123TA6673](#)

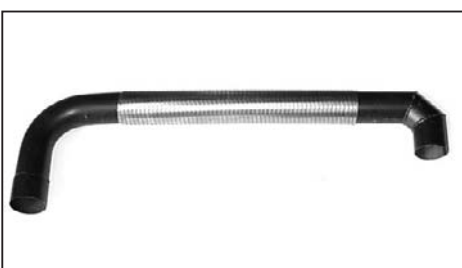

REF [108TA4422](#)



REF [105TA6933](#)

EXHAUST TUBES

For all our latest catalogue updates and company info: www.tvh.com

EXHAUST TUBES

used for: **KOMATSU**

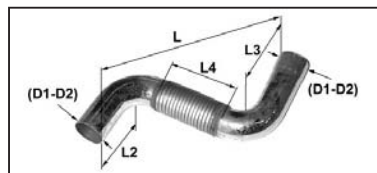

Number of bends AT-BO	Smallest outer dia. tube (mm) D1	Largest outer dia. tube (mm) D2	Dimension (mm) L	Dimension (mm) L2	Dimension (mm) L3	Dimension (mm) L4	REF
3	34	35	240	10	43		124TA2870
	34	35	400	80	290	110	105TA7184
	35	35	175	50	90		124TA1071
	35	48	580	70	113		118TA1512
	37	37	368	65	120		123TA6674
	37	40	565	37	75	150	134TA5600
	38	42	390	85	105	140	134TA5930
	38	47	470	70	90	130	134TA6200
	41	43	490	95	192	145	118TA1643
	41	45	360	73	150	150	118TA1487
	41	47	415	60	100		123TA6675
	42	42	400	95	105		134TA5865

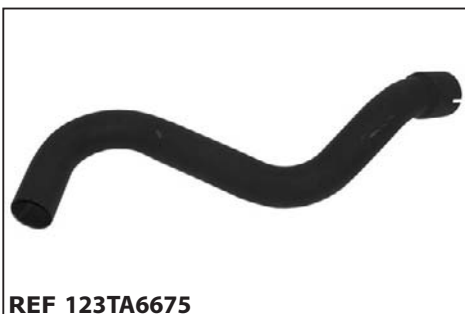
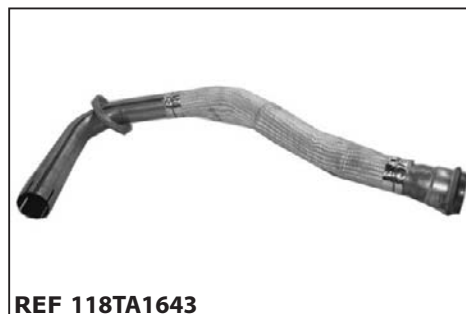

EXHAUST TUBES

For all our latest catalogue updates and company info: www.tvh.com



EXHAUST TUBES

used for: **KOMATSU**

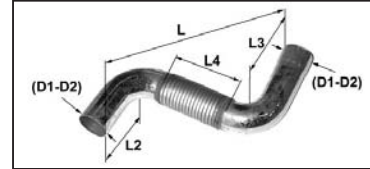

Number of bends AT-BO	Smallest outer dia. tube (mm) D1	Largest outer dia. tube (mm) D2	Dimension (mm) L	Dimension (mm) L2	Dimension (mm) L3	Dimension (mm) L4	REF
3	42	44	495	70	310	225	134TA5628
	42	46	358	45	50	178	108TA4502
	42	47	440	45	95	175	134TA5548
	43	43	425	80	90	140	105TA7188
	43	43	675	70	220		105TA7236
	43	44	580	40	70	310	118TA1377
	43	46	420	75	125	150	105TA7172
	43	46	568	130	160	230	105TA7414
	43	47	515	65	255	160	105TA7223
	44	44	475	85	380	190	108TA4417
	44	44	605	20	340	230	139TA3983
	44	44	620	50	330	230	108TA4508

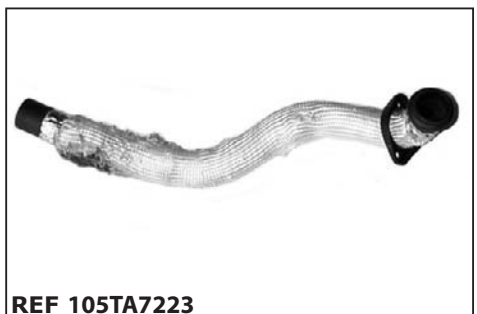
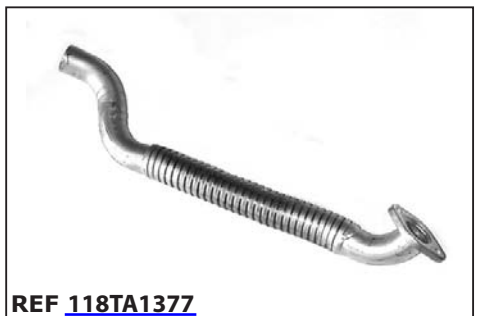

EXHAUST TUBES

For all our latest catalogue updates and company info: www.tvh.com

EXHAUST TUBES

used for: **KOMATSU**

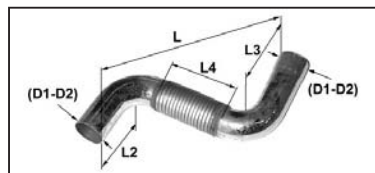

Number of bends AT-BO	Smallest outer dia. tube (mm) D1	Largest outer dia. tube (mm) D2	Dimension (mm) L	Dimension (mm) L2	Dimension (mm) L3	Dimension (mm) L4	REF
3	45	45	525	40	115	345	134TA6250
	45	50	330	55	70		139TA3984
	45	51	600	255	450		123TA6676
	45	51	700	20	195	100	108TA4553
	45	52	722	25	250	160	123TA6677
	47	47	525	115	115		108TA4382
	47	48	510	90	100		123TA6678
	47	51	335	40	70		118TA1379
	50	80	885	110	210	100	134TA6338
	51	51	370	40	200		134TA5775
	51	51	705	110	125	115	134TA5680
	51	54	883	110	125	110	108TA4505



REF [134TA6250](#)



REF [139TA3984](#)



REF [123TA6676](#)

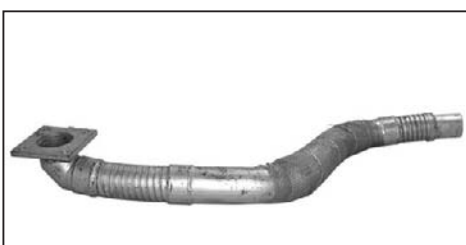

REF [108TA4553](#)



REF [123TA6677](#)



REF [108TA4382](#)



REF [123TA6678](#)

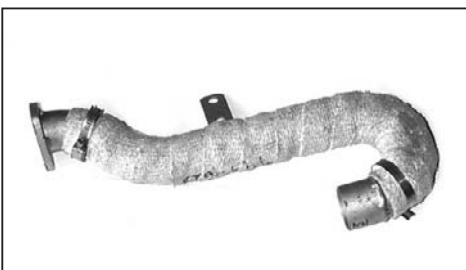

REF [118TA1379](#)



REF [134TA6338](#)



REF [134TA5775](#)



REF [134TA5680](#)



REF [108TA4505](#)

EXHAUST TUBES

For all our latest catalogue updates and company info: www.tvh.com



EXHAUST TUBES

used for: **KOMATSU**

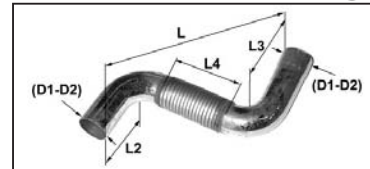

Number of bends AT-BO	Smallest outer dia. tube (mm) D1	Largest outer dia. tube (mm) D2	Dimension (mm) L	Dimension (mm) L2	Dimension (mm) L3	Dimension (mm) L4	REF
3	58	62	450	25	75		134TA5849
4	34	38	630	130	160	110	134TA6288
	34	43	575	15	105	155	105TA7068
	35	42	280	65	125	150	139TA3985
	38	39	355	65	135		108TA4443
	38	41	570	150	180		105TA7453
	38	41	595	70	170	145	118TA1641
	41	41	560	165	200		123TA6680
	42	42	300	60	100		139TA3986
	42	42	550	20	80		134TA5848
	42	43	460	95	115	160	108TA4477
	42	43	555	145	185		118TA1454

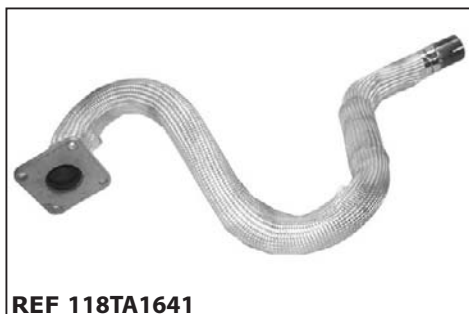

EXHAUST TUBES

For all our latest catalogue updates and company info: www.tvh.com

used for: **KOMATSU**

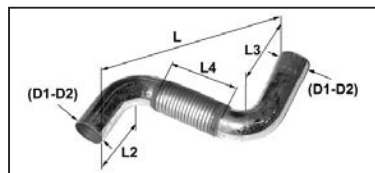

EXHAUST TUBES

Number of bends AT-BO	Smallest outer dia. tube (mm) D1	Largest outer dia. tube (mm) D2	Dimension (mm) L	Dimension (mm) L2	Dimension (mm) L3	Dimension (mm) L4	REF
4	42	45	525	35	90		105TA7204
	43	43	525	35	90		105TA7205
	43	45	610	60	75	310	118TA1427
	43	48	455	60	130		118TA1576
	44	51	740	55	177	170	118TA1537
	44	51	747	50	180	105	106TA5016
	45	45	560	40	100	270	134TA6139
	45	45	570	70	80	260	118TA1496
	45	50	525	80	80	120	134TA5755
	45	51	890	43	135	430	110TA9621
	48	51	720	35	276		123TA6681
	49	50	630	80	120	325	118TA1672

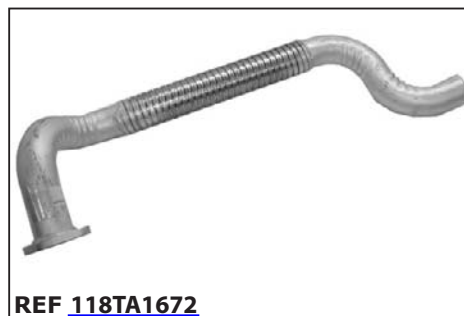
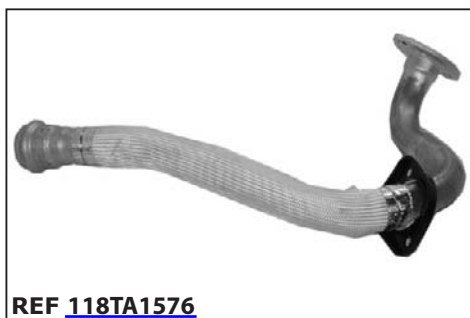
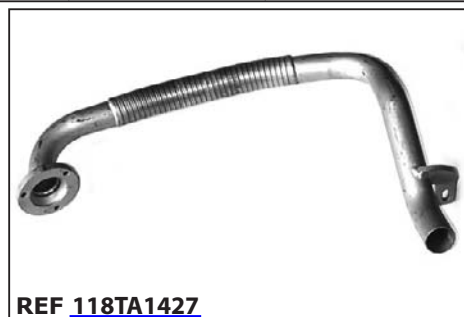

EXHAUST TUBES

For all our latest catalogue updates and company info: www.tvh.com



EXHAUST TUBES

used for: **KOMATSU**

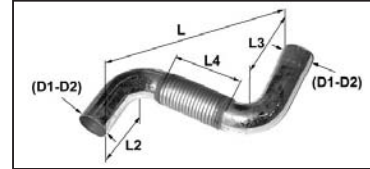

Number of bends	Smallest outer dia. tube (mm)	Largest outer dia. tube (mm)	Dimension (mm)	Dimension (mm)	Dimension (mm)	Dimension (mm)	REF
AT-BO	D1	D2	L	L2	L3	L4	
4	50	50	700	40	40	380	118TA1586
	50	50	1010	30	200	240	134TA5896
	50	51	540	55	65	230	118TA1444
	51	51	920	70	170	150	123TA6682
	51	53	870	85	95	130	105TA6886
	56	57	695	28	95		139TA3987
5	33	33	515	60	115	155	105TA7137
	34	34	575	75	120	165	105TA6972
	34	34	625	60	220		110TA9614
	34	37	620	132	158	170	111TA1902
	34	43	540	115	280	115	134TA5717
	34	63	476	25	120	163	108TA4482

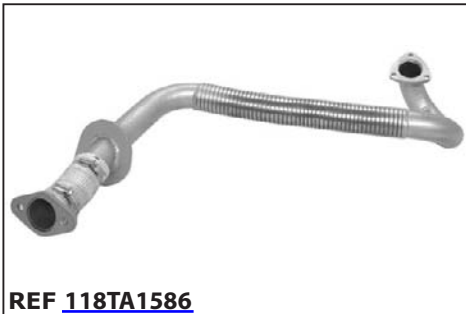

EXHAUST TUBES

For all our latest catalogue updates and company info: www.tvh.com

EXHAUST TUBES

used for: **KOMATSU**

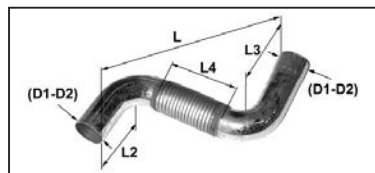

Number of bends AT-BO	Smallest outer dia. tube (mm) D1	Largest outer dia. tube (mm) D2	Dimension (mm) L	Dimension (mm) L2	Dimension (mm) L3	Dimension (mm) L4	REF
5	35	40	580	70	85	150	134TA6009
	37	38	690	80	160		106TA5023
	38	38	135	7	54		134TA5766
	39	42	695	110	270	145	134TA6342
	40	40	705	85	200		118TA1609
	42	42	530	70	190		134TA6246
	43	43	645	20	235		105TA7435
	43	45	810	55	65	350	134TA6283
	44	45	445	45	65	300	134TA6023
	45	45	780	55	80		139TA3988
	50	50	660	45	45	305	118TA1445
	50	50	745	40	60	280	118TA1399

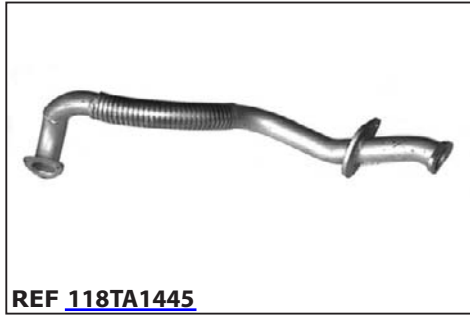
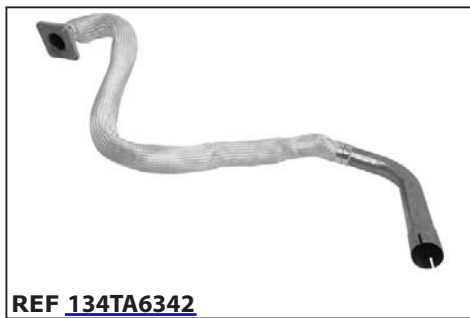

EXHAUST TUBES

For all our latest catalogue updates and company info: www.tvh.com



EXHAUST TUBES

used for: **KOMATSU**

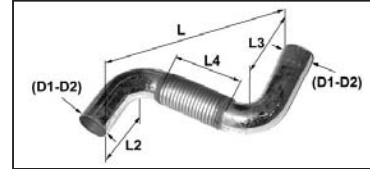

Number of bends AT-BO	Smallest outer dia. tube (mm) D1	Largest outer dia. tube (mm) D2	Dimension (mm) L	Dimension (mm) L2	Dimension (mm) L3	Dimension (mm) L4	REF
5	51	51	780	30	220	200	139TA3989
	51	51	960	50	130	325	118TA1652
6	34	34	630	70	275	105	105TA6884
	34	38	800	90	95	155	134TA5922
	43	43	470	53	55	180	134TA5993
	50	50	550	50	100	300	134TA6231
	50	50	660	45	65	270	118TA1420

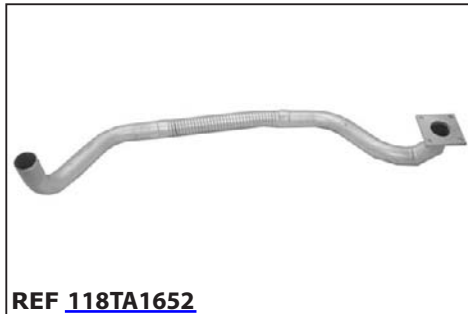

Look up these parts via

EXHAUST TUBES

For all our latest catalogue updates and company info: www.tvh.com

EXHAUST TUBES

used for: **KOOI AAP**

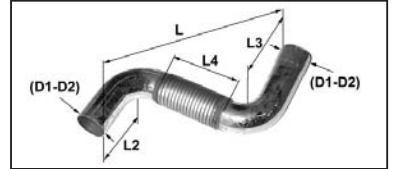

Number of bends AT-BO	Smallest outer dia. tube (mm) D1	Largest outer dia. tube (mm) D2	Dimension (mm) L	Dimension (mm) L2	Dimension (mm) L3	Dimension (mm) L4	REF
1	35	35	102	32	74		134TA6049
2	42	42	235	30	135		134TA6020
	42	42	252	25	80		110TA8599
	43	51	560	60	420		134TA6054
	50	48	260	35	95		134TA6076



EXHAUST TUBES

For all our latest catalogue updates and company info: www.tvh.com



EXHAUST TUBES

used for: **LINDE-LANSING**

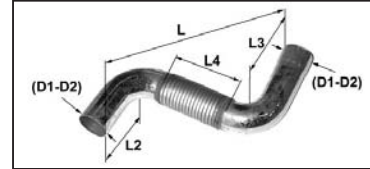

Number of bends AT-BO	Smallest outer dia. tube (mm) D1	Largest outer dia. tube (mm) D2	Dimension (mm) L	Dimension (mm) L2	Dimension (mm) L3	Dimension (mm) L4	REF
0	38	38	415			300	106TA6329
	38	45	420			285	105TA7196
	38	49	317			180	118TA1493
	40	40	65				118TA1664
	42	42	290				108TA4431
	42	42	395				108TA4424
	42	42	475				108TA4427
	42	42	570				108TA4433
	42	45	300				118TA1636
	42	45	335				105TA6941
	42	46	1025				118TA1219
	43	51	1085				134TA5696



EXHAUST TUBES

For all our latest catalogue updates and company info: www.tvh.com

EXHAUST TUBES

used for: **LINDE-LANSING**

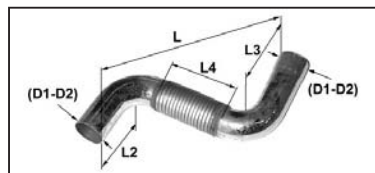

Number of bends AT-BO	Smallest outer dia. tube (mm) D1	Largest outer dia. tube (mm) D2	Dimension (mm) L	Dimension (mm) L2	Dimension (mm) L3	Dimension (mm) L4	REF
0	48	50	81				134TA6237
	49	49	780				134TA6131
	51	54	300				123TA6683
	53	59	430			180	124TA7235
	54	54	210			115	118TA1597
	54	60	398			210	123TA6684
	68	70	160				124TA7242
1	30	30	215	20	195		134TA5986
	38	38	75	35	65		105TA7406
	38	56	345	75	265	145	123TA6685
	40	41	1970	55	1925	1000	118TA1499
	40	46	1630	35	730	710	134TA5618



REF [134TA6237](#)



REF [134TA6131](#)



REF [123TA6683](#)



REF [124TA7235](#)

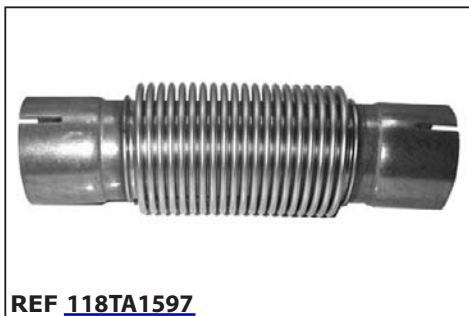

REF [118TA1597](#)



REF [123TA6684](#)



REF [124TA7242](#)



REF [134TA5986](#)



REF [105TA7406](#)



REF [123TA6685](#)



REF [118TA1499](#)

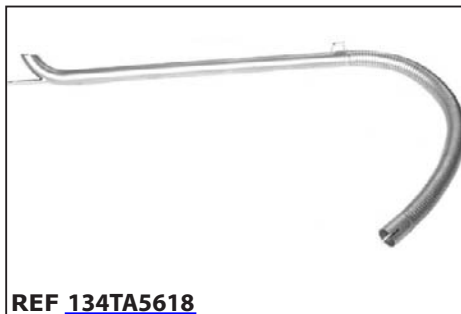

REF [134TA5618](#)

EXHAUST TUBES

For all our latest catalogue updates and company info: www.tvh.com



EXHAUST TUBES

used for: **LINDE-LANSING**

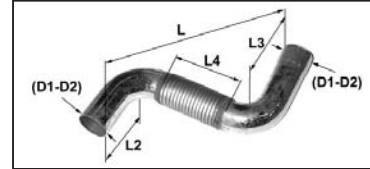

Number of bends AT-BO	Smallest outer dia. tube (mm) D1	Largest outer dia. tube (mm) D2	Dimension (mm) L	Dimension (mm) L2	Dimension (mm) L3	Dimension (mm) L4	REF
1	40	46	1710	53	1680	825	134TA5666
	42	42	235	70	180		139TA3990
	42	42	472	460	40	410	134TA5620
	42	51	270	140	230		118TA1446
	44	49	926	80	900		134TA5625
	44	52	180	60	150		118TA1392
	45	45	75	35	40		118TA1393
	45	48	1620	45	1600		134TA5646
	45	49	485	110	410		118TA1439
	48	48	215	90	105		108TA4394
	48	50	215	80	175		134TA5526
	49	53	225	20	200		134TA5971



REF [134TA5666](#)



REF [139TA3990](#)

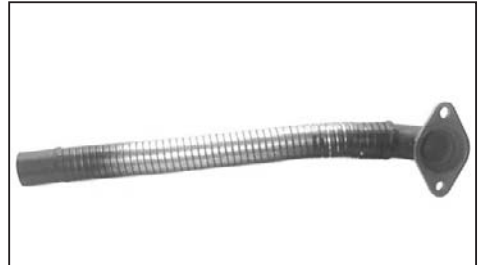

REF [134TA5620](#)



REF [118TA1446](#)

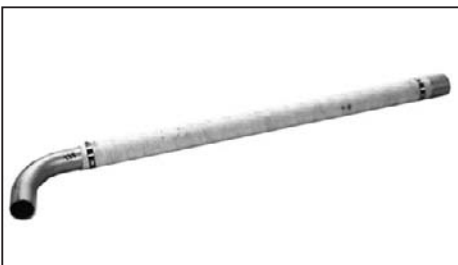

REF [134TA5625](#)



REF [118TA1392](#)



REF [118TA1393](#)



REF [134TA5646](#)



REF [118TA1439](#)



REF [108TA4394](#)



REF [134TA5526](#)



REF [134TA5971](#)

EXHAUST TUBES

For all our latest catalogue updates and company info: www.tvh.com

used for: **LINDE-LANSING**

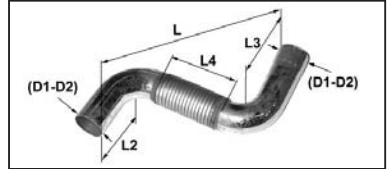

EXHAUST TUBES

Number of bends AT-BO	Smallest outer dia. tube (mm) D1	Largest outer dia. tube (mm) D2	Dimension (mm) L	Dimension (mm) L2	Dimension (mm) L3	Dimension (mm) L4	REF
1	50	50	145	50	110		134TA6209
	50	50	153	100	100		134TA6262
	50	50	155	125	310	160	134TA5955
	50	50	645	135	600	160	134TA5874
	50	51	150	135	165		134TA6316
	50	53	157	50	107		134TA6087
	50	54	115	60	68		110TA9619
	50	54	200	75	165		134TA5523
	50	55	840	90	800		134TA5692
	50	55	845	75	820		134TA5555
	51	51	155	175	200		118TA1601
	51	51	225	50	205		118TA1614



REF [134TA6209](#)



REF [134TA6262](#)



REF [134TA5955](#)



REF [134TA5874](#)



REF [134TA6316](#)



REF [134TA6087](#)



REF [110TA9619](#)



REF [134TA5523](#)



REF [134TA5692](#)

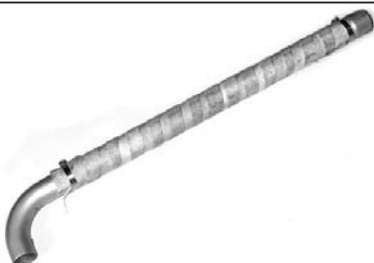

REF [134TA5555](#)



REF [118TA1601](#)



REF [118TA1614](#)

EXHAUST TUBES

For all our latest catalogue updates and company info: www.tvh.com



EXHAUST TUBES

used for: **LINDE-LANSING**

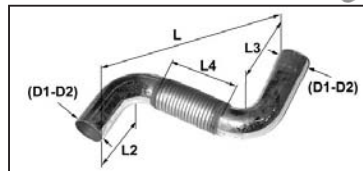

Number of bends AT-BO	Smallest outer dia. tube (mm) D1	Largest outer dia. tube (mm) D2	Dimension (mm) L	Dimension (mm) L2	Dimension (mm) L3	Dimension (mm) L4	REF
1	51	51	270	90	175		124TA5154
	51	51	440	70	400		105TA7373
	51	53	560	50	530		124TA2865
	51	54	650	290	500	280	118TA1505
	51	54	805	160	764		108TA4372
	51	55	170	84	97		108TA4463
	51	56	300	80	275		118TA1464
	52	54	380	200	235		105TA7374
	52	57	175	70	140		118TA1573
	55	36	1025	80	1030		124TA7239
	55	55	250	100	175		134TA5991
	55	55	1405	40	138		134TA5760



EXHAUST TUBES

For all our latest catalogue updates and company info: www.tvh.com

EXHAUST TUBES

used for: **LINDE-LANSING**

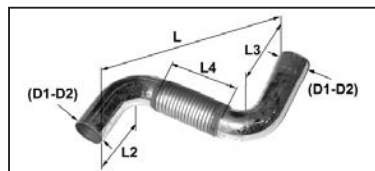

Number of bends AT-BO	Smallest outer dia. tube (mm) D1	Largest outer dia. tube (mm) D2	Dimension (mm) L	Dimension (mm) L2	Dimension (mm) L3	Dimension (mm) L4	REF
1	55	57	370	50	360		118TA1678
	55	60	270	135	160		105TA7120
	56	52	210	70	180		123TA6686
	56	59	610	145	480		106TA7368
	60	65	485	185	340		124TA2076
	60	66	1400	300	1210		118TA1509
	60	67	295	120	240		118TA1435
	60	67	297	125	260		118TA1497
	60	68	295	115	235		118TA1426
	60	68	302	115	260		118TA1698
	60	68	590	120	565		134TA5746
	60	79	294	90	210		118TA1480



EXHAUST TUBES

For all our latest catalogue updates and company info: www.tvh.com



EXHAUST TUBES

used for: **LINDE-LANSING**

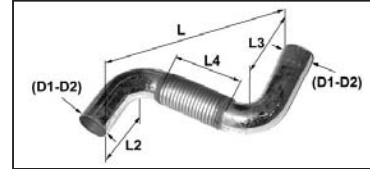

Number of bends AT-BO	Smallest outer dia. tube (mm) D1	Largest outer dia. tube (mm) D2	Dimension (mm) L	Dimension (mm) L2	Dimension (mm) L3	Dimension (mm) L4	REF
1	63	63	535	195	440	215	139TA3991
	68	70	300	125	245		118TA1422
	68	70	900	120	900		134TA5952
	70	70	180	150	160		134TA6010
	70	70	205	75	160		105TA7300
	70	70	290	140	180		134TA6012
	70	70	340	65	280		118TA1436
	76	76	225	60	220		134TA5987
	76	76	345	70	275		123TA6687
	76	80	140	80	80		124TA5155
	76	82	630	180	565		123TA6688
	77	77	240	60	180		134TA5942



EXHAUST TUBES

For all our latest catalogue updates and company info: www.tvh.com

used for: **LINDE-LANSING**

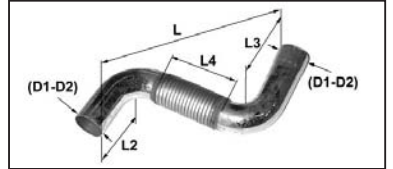

EXHAUST TUBES

Number of bends AT-BO	Smallest outer dia. tube (mm) D1	Largest outer dia. tube (mm) D2	Dimension (mm) L	Dimension (mm) L2	Dimension (mm) L3	Dimension (mm) L4	REF
1	77	80	1730	90	1700		124TA1113
	80	80	370	100	280		118TA1461
	83	83	590	70	535		124TA2868
	124	132	2220	620	1660		134TA6090
2	29	29	380	80	170		106TA7375
	36	36	150	35	45		134TA6153
	40	40	460	87	280		134TA6123
	40	41	500	140	285		134TA5568
	40	42	225	90	110		134TA6273
	41	44	385	60	70	160	134TA6218
	41	48	420	80	85	140	123TA6690
	42	45	355	35	240	165	134TA5683



EXHAUST TUBES

For all our latest catalogue updates and company info: www.tvh.com



EXHAUST TUBES

used for: **LINDE-LANSING**

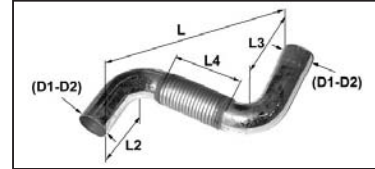

Number of bends AT-BO	Smallest outer dia. tube (mm) D1	Largest outer dia. tube (mm) D2	Dimension (mm) L	Dimension (mm) L2	Dimension (mm) L3	Dimension (mm) L4	REF
2	42	45	1440	80	110	840	134TA5559
	42	47	370	60	70	210	134TA6080
	44	46	350	50	120		105TA7292
	44	46	390	150	180	240	134TA6230
	44	51	90	22	45		118TA1477
	45	45	165	70	125		105TA6994
	45	45	220	50	70		105TA7385
	45	45	300	65	85		105TA7351
	45	45	415	110	120		118TA1452
	46	46	370	55	95		118TA1450
	46	46	375	95	100		118TA1398
	47	50	440	90	250		134TA5802



EXHAUST TUBES

For all our latest catalogue updates and company info: www.tvh.com

EXHAUST TUBES

used for: **LINDE-LANSING**

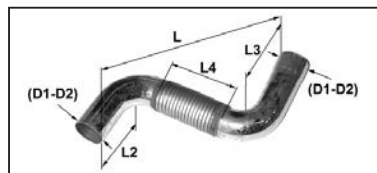

Number of bends AT-BO	Smallest outer dia. tube (mm) D1	Largest outer dia. tube (mm) D2	Dimension (mm) L	Dimension (mm) L2	Dimension (mm) L3	Dimension (mm) L4	REF
2	47	56	955	10	135		134TA5733
	48	48	495	85	150		105TA7314
	48	48	955	220	555		118TA1440
	48	49	526	70	415		134TA6094
	48	52	420	20	120		105TA7029
	49	50	455	100	110		118TA1403
	49	51	655	55	395	290	134TA6001
	49	56	260	35	50		134TA6259
	50	50	300	30	85		118TA1408
	50	50	390	80	290		134TA5783
	50	50	440	85	120		134TA5784
	50	51	320	35	80		134TA6146



EXHAUST TUBES

For all our latest catalogue updates and company info: www.tvh.com



EXHAUST TUBES

used for: **LINDE-LANSING**

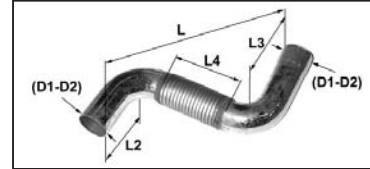

Number of bends AT-BO	Smallest outer dia. tube (mm) D1	Largest outer dia. tube (mm) D2	Dimension (mm) L	Dimension (mm) L2	Dimension (mm) L3	Dimension (mm) L4	REF
2	50	51	500	100	410	130	108TA4439
	50	51	595	70	400	285	139TA3992
	50	54	260	85	90		124TA5156
	50	55	480	50	415	210	134TA5754
	51	51	585	55	153		134TA6330
	51	51	645	55	400	285	134TA5690
	51	53	590	60	405	200	134TA5715
	51	54	500	90	115	150	139TA3993
	51	55	445	45	120		134TA5681
	51	55	685	60	410	210	134TA5684
	51	60	305	35	80		118TA1419
	51	69	260	20	65		118TA1529

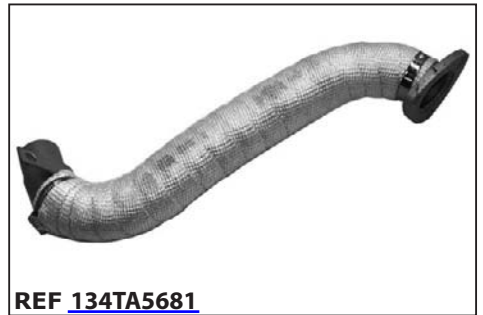

EXHAUST TUBES

For all our latest catalogue updates and company info: www.tvh.com

EXHAUST TUBES

used for: **LINDE-LANSING**

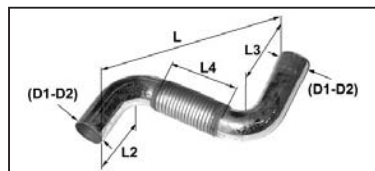

Number of bends AT-BO	Smallest outer dia. tube (mm) D1	Largest outer dia. tube (mm) D2	Dimension (mm) L	Dimension (mm) L2	Dimension (mm) L3	Dimension (mm) L4	REF
2	52	56	362	105	150		134TA6208
	54	54	300	110	170		134TA6119
	54	54	375	135	145		105TA7364
	54	60	500	135	175		105TA7325
	54	76	350	45	125	220	139TA3994
	60	64	450	245	165		134TA6003
	63	63	110	55	25		134TA6051
	72	72	372	160	250		123TA6691
	75	80	484	120	135		139TA3995
3	30	30	300	20	65		134TA5984
	30	50	240	20	55		134TA5985
	38	42	625	175	255		105TA7331



EXHAUST TUBES

For all our latest catalogue updates and company info: www.tvh.com



EXHAUST TUBES

used for: **LINDE-LANSING**

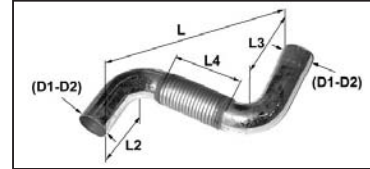

Number of bends AT-BO	Smallest outer dia. tube (mm) D1	Largest outer dia. tube (mm) D2	Dimension (mm) L	Dimension (mm) L2	Dimension (mm) L3	Dimension (mm) L4	REF
3	43	44	580	40	70	310	134TA5499
	43	46	685	140	225		118TA1425
	44	45	330	25	160		105TA7291
	44	45	405	20	170	230	134TA5521
	44	49	380	33	50	240	134TA6248
	45	45	525	40	115	345	134TA6252
	45	50	330	55	70		139TA3996
	47	51	335	40	70		134TA5501
	48	48	440	125	175		118TA1432
	48	50	350	30	115		124TA7243
	49	51	225	60	100		139TA3997
	49	53	315	20	50		134TA5970



EXHAUST TUBES

For all our latest catalogue updates and company info: www.tvh.com

EXHAUST TUBES

used for: **LINDE-LANSING**

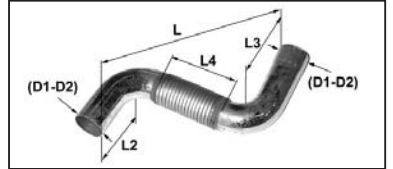

Number of bends AT-BO	Smallest outer dia. tube (mm) D1	Largest outer dia. tube (mm) D2	Dimension (mm) L	Dimension (mm) L2	Dimension (mm) L3	Dimension (mm) L4	REF
3	50	48	240	60	130		139TA3998
	50	50	228	60	85		118TA1583
	50	50	235	55	95		134TA6085
	50	50	235	60	135		134TA5764
	50	50	265	55	125		139TA3999
	50	50	283	25	120		139TA4000
	50	50	345	50	100		139TA4001
	50	50	360	25	105		134TA6227
	50	55	240	20	40		134TA5972
	51	54	1220	265	950		124TA2080
	51	55	1005	110	255		134TA6331
	64	69	350	50	105		118TA1453



REF [139TA3998](#)



REF [118TA1583](#)



REF [134TA6085](#)



REF [134TA5764](#)



REF [139TA3999](#)

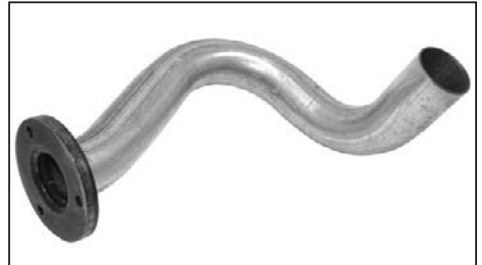

REF [139TA4000](#)



REF [139TA4001](#)



REF [134TA6227](#)



REF [134TA5972](#)



REF [124TA2080](#)



REF [134TA6331](#)



REF [118TA1453](#)

EXHAUST TUBES

For all our latest catalogue updates and company info: www.tvh.com



EXHAUST TUBES

used for: **LINDE-LANSING**

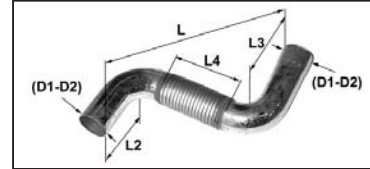

Number of bends	Smallest outer dia. tube (mm)	Largest outer dia. tube (mm)	Dimension (mm)	Dimension (mm)	Dimension (mm)	Dimension (mm)	REF
AT-BO	D1	D2	L	L2	L3	L4	
3	66	69	340	50	80		123TA6692
	70	70	865	100	730	200	139TA4002
	90	127	950	120	260	210	134TA6013
4	38	41	595	70	170	145	123TA6693
	42	43	555	145	185		124TA4491
	42	45	635	70	85		105TA7212
	43	45	610	60	75	310	134TA5557
	45	45	560	40	100	270	134TA6141
	45	45	570	70	80	260	134TA5643
	45	50	525	80	80	120	134TA5757
	48	51	720	35	276		123TA6694
	48	58	685	35	145		118TA1441

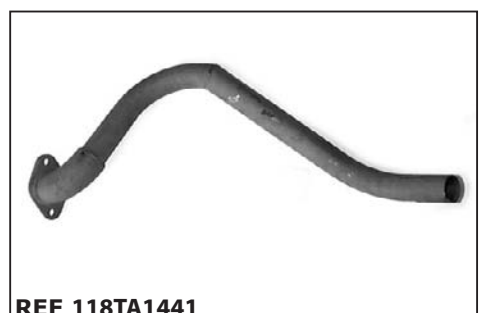
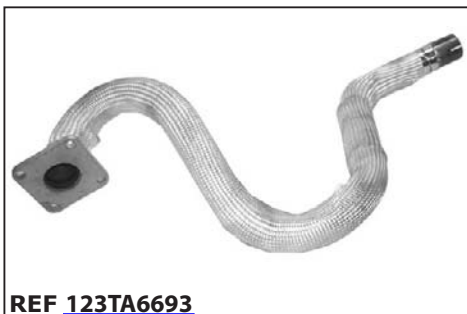

EXHAUST TUBES

For all our latest catalogue updates and company info: www.tvh.com

used for: **LINDE-LANSING**

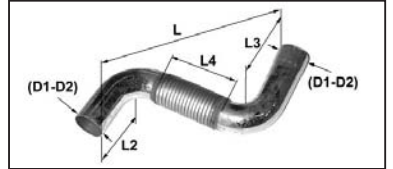

EXHAUST TUBES

Number of bends AT-BO	Smallest outer dia. tube (mm) D1	Largest outer dia. tube (mm) D2	Dimension (mm) L	Dimension (mm) L2	Dimension (mm) L3	Dimension (mm) L4	REF
4	49	50	630	80	120	325	134TA5670
	50	50	410	60	85		134TA5745
	50	50	700	40	40	380	134TA5663
	50	51	540	55	65	230	134TA5571
	50	55	290	40	100		139TA4003
	52	52	545	75	385	80	105TA6958
	54	57	750	35	155		118TA1429
	55	55	825	30	175		118TA1389
	55	58	640	35	155		118TA1430
	56	57	800	35	160		118TA1428
	60	62	515	130	385		134TA5701
5	35	45	785	20	60	340	134TA5556



REF [134TA5670](#)



REF [134TA5745](#)



REF [134TA5663](#)



REF [134TA5571](#)



REF [139TA4003](#)



REF [105TA6958](#)



REF [118TA1429](#)

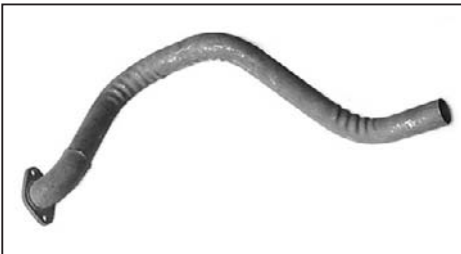

REF [118TA1389](#)

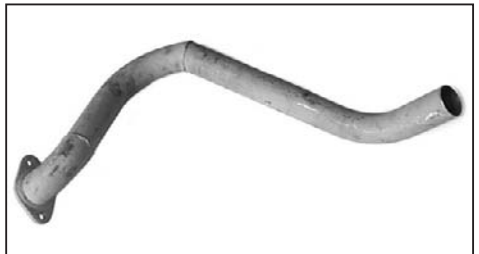

REF [118TA1430](#)



REF [118TA1428](#)



REF [134TA5701](#)

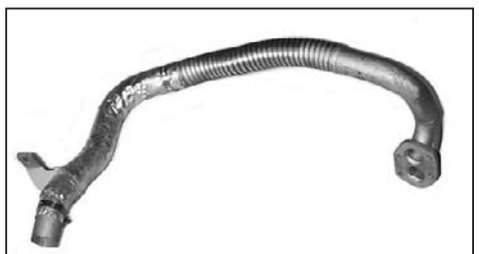

REF [134TA5556](#)

EXHAUST TUBES

For all our latest catalogue updates and company info: www.tvh.com



EXHAUST TUBES

used for: **LINDE-LANSING**

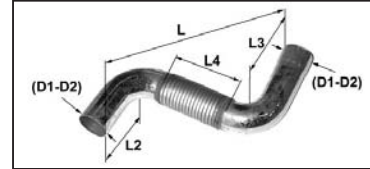

Number of bends	Smallest outer dia. tube (mm)	Largest outer dia. tube (mm)	Dimension (mm)	Dimension (mm)	Dimension (mm)	Dimension (mm)	REF
AT-BO	D1	D2	L	L2	L3	L4	
5	38	38	135	7	54		134TA5767
	43	45	810	55	65	350	134TA6285
	44	45	445	45	65	300	134TA6025
	45	45	780	55	80		139TA4004
	50	50	660	45	45	305	134TA5572
	50	50	745	40	60	280	134TA5522
6	50	50	550	50	100	300	134TA6233
	50	50	660	45	65	270	134TA5544
	50	50	830	60	60	360	134TA5550



EXHAUST TUBES

For all our latest catalogue updates and company info: www.tvh.com

EXHAUST TUBES

used for: **LUGLI**

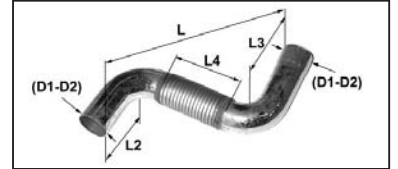

Number of bends AT-BO	Smallest outer dia. tube (mm) D1	Largest outer dia. tube (mm) D2	Dimension (mm) L	Dimension (mm) L2	Dimension (mm) L3	Dimension (mm) L4	REF
0	56	60	630			500	139TA4005
1	45	49	100	20	75		134TA6355



Look up these parts via

EXHAUST TUBES

For all our latest catalogue updates and company info: www.tvh.com



EXHAUST TUBES

used for: **MANITOU**

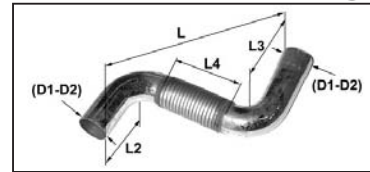

Number of bends	Smallest outer dia. tube (mm)	Largest outer dia. tube (mm)	Dimension (mm)	Dimension (mm)	Dimension (mm)	Dimension (mm)	REF
AT-BO	D1	D2	L	L2	L3	L4	
0	48	48	175				118TA1669
	48	61	1055				134TA6300
	55	55	176				134TA6053
	59	59	232			147	108TA4445
	61	61	180			138	108TA4416
1	36	38	390	80	435	260	139TA4006
	42	42	125	50	75		139TA4007
	43	47	127	25	90		123TA6695
	45	49	100	20	75		134TA6354
	50	56	124	50	110		134TA6299
	55	60	115	35	90		105TA6934
	56	56	305	20	285		134TA5798



EXHAUST TUBES

For all our latest catalogue updates and company info: www.tvh.com

EXHAUST TUBES

used for: **MANITOU**

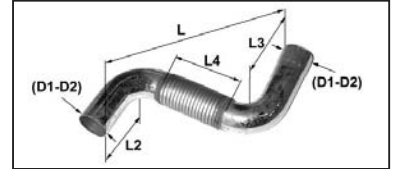

Number of bends AT-BO	Smallest outer dia. tube (mm) D1	Largest outer dia. tube (mm) D2	Dimension (mm) L	Dimension (mm) L2	Dimension (mm) L3	Dimension (mm) L4	REF
1	58	61	690	250	450		139TA4008
	58	65	445	270	305	175	124TA7233
	60	64	105	25	80		108TA4507
	60	77	245	130	210		134TA5965
	61	64	323	90	305	170	134TA6007
	70	70	330	120	280	140	134TA6270
	70	76	220	120	150		124TA7241
	76	90	335	30	310		139TA4009
2	41	50	500	100	285		108TA4539
	42	55	690	60	330		134TA5797
	42	56	290	85	100		134TA5799
	42	60	117	52	90		108TA4538



EXHAUST TUBES

For all our latest catalogue updates and company info: www.tvh.com



EXHAUST TUBES

used for: **MANITOU**

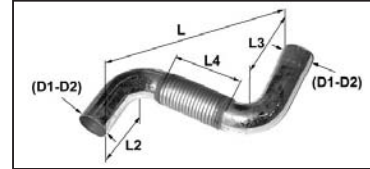

Number of bends AT-BO	Smallest outer dia. tube (mm) D1	Largest outer dia. tube (mm) D2	Dimension (mm) L	Dimension (mm) L2	Dimension (mm) L3	Dimension (mm) L4	REF
2	42	63	680	45	288	220	118TA1602
	43	61	352	25	82		118TA1603
	45	48	375	30	250	50	139TA4010
	45	50	532	130	495		139TA4011
	46	50	417	110	180		118TA1521
	47	50	220	30	120		134TA6214
	48	48	510	120	180		134TA6056
	54	56	1170	20	60		124TA7629
	54	60	475	95	100	150	134TA6067
	54	62	730	130	190	155	134TA6157
	55	60	480	80	95		108TA4537
	56	60	370	65	70		134TA5933



EXHAUST TUBES

For all our latest catalogue updates and company info: www.tvh.com

EXHAUST TUBES

used for: **MANITOU**

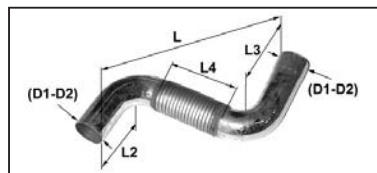

Number of bends AT-BO	Smallest outer dia. tube (mm) D1	Largest outer dia. tube (mm) D2	Dimension (mm) L	Dimension (mm) L2	Dimension (mm) L3	Dimension (mm) L4	REF
2	56	65	933	110	650		118TA1642
	60	60	350	110	120	70	139TA4012
	60	60	370	50	100	160	108TA4506
	60	61	205	55	115		139TA4013
	60	62	270	20	90	150	139TA4014
	60	65	295	35	75	130	134TA6052
	64	64	450	110	120	168	123TA6696
	64	72	435	110	115	145	134TA6212
3	42	42	750	75	120	150	139TA4015
	42	50	435	50	95		134TA5868
	54	64	760	30	125	115	134TA5790
	54	72	390	55	190	115	139TA4016



REF [118TA1642](#)



REF [139TA4012](#)



REF [108TA4506](#)



REF [139TA4013](#)



REF [139TA4014](#)



REF [134TA6052](#)



REF [123TA6696](#)



REF [134TA6212](#)

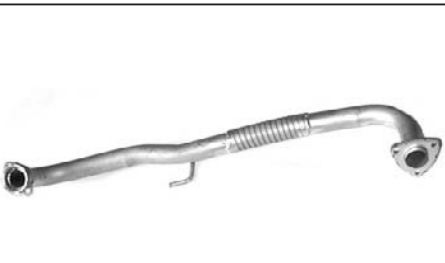

REF [139TA4015](#)



REF [134TA5868](#)



REF [134TA5790](#)



REF [139TA4016](#)

EXHAUST TUBES

For all our latest catalogue updates and company info: www.tvh.com



EXHAUST TUBES

used for: **MANITOU**

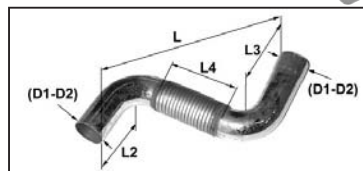

Number of bends AT-BO	Smallest outer dia. tube (mm) D1	Largest outer dia. tube (mm) D2	Dimension (mm) L	Dimension (mm) L2	Dimension (mm) L3	Dimension (mm) L4	REF
3	55	60	255	55	100		108TA4415
	60	60	1080	20	130		134TA6070
	60	60	1265	70	490		139TA4017
	60	60	1770	30	120		139TA4018
	60	64	815	60	245	160	139TA4019
	60	65	290	80	145		134TA5945
	60	79	1775	30	125		123TA6697
	64	72	350	200	250	160	124TA1082
	64	72	410	180	245	145	134TA6160
	64	72	520	100	245	140	123TA6698
	65	65	490	30	80	115	134TA5810
4	49	60	500	55	70	140	134TA6332



REF [108TA4415](#)



REF [134TA6070](#)



REF [139TA4017](#)



REF [139TA4018](#)



REF [139TA4019](#)



REF [134TA5945](#)



REF [123TA6697](#)



REF [124TA1082](#)



REF [134TA6160](#)



REF [123TA6698](#)



REF [134TA5810](#)

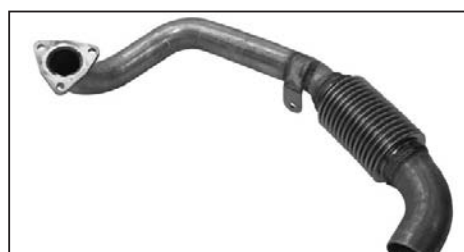

REF [134TA6332](#)

EXHAUST TUBES

For all our latest catalogue updates and company info: www.tvh.com



EXHAUST TUBES

used for: **MERLO**

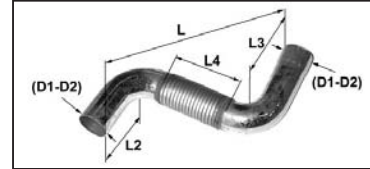

Number of bends	Smallest outer dia. tube (mm)	Largest outer dia. tube (mm)	Dimension (mm)	Dimension (mm)	Dimension (mm)	Dimension (mm)	REF
AT-BO	D1	D2	L	L2	L3	L4	
1	74	74	57	34	38		134TA5723
2	54	61	630	35	300	180	134TA6296
	65	65	810	75	540	200	134TA6002
3	65	70	885	75	150	155	139TA4020
4	64	71	980	50	100	175	134TA6359
	65	70	1000	100	145		134TA6006
	65	70	1033	80	110	155	139TA4021



EXHAUST TUBES

For all our latest catalogue updates and company info: www.tvh.com

EXHAUST TUBES

used for: **MITSUBISHI-CATERPILLAR**

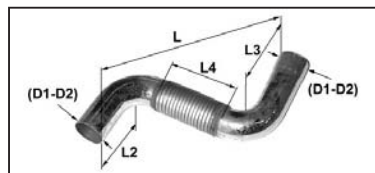

Number of bends AT-BO	Smallest outer dia. tube (mm) D1	Largest outer dia. tube (mm) D2	Dimension (mm) L	Dimension (mm) L2	Dimension (mm) L3	Dimension (mm) L4	REF
0	42	45	315			215	139TA4022
	42	47	151				139TA4023
	51	55	300			205	105TA7119
	54	63	153				139TA4024
	55	55	580			470	105TA7151
	61	61	66				139TA4025
	68	68	315				134TA6074
	69	69	378			368	123TA6580
	77	77	125				139TA4026
	101	106	350			300	134TA6289
1	35	51	460	170	408		118TA1540
	38	41	175	80	155		105TA6930



EXHAUST TUBES

For all our latest catalogue updates and company info: www.tvh.com



EXHAUST TUBES

used for: **MITSUBISHI-CATERPILLAR**

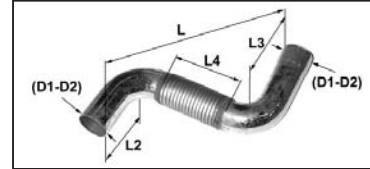

Number of bends AT-BO	Smallest outer dia. tube (mm) D1	Largest outer dia. tube (mm) D2	Dimension (mm) L	Dimension (mm) L2	Dimension (mm) L3	Dimension (mm) L4	REF
1	38	42	285	65	245	155	139TA4027
	38	42	310	110	285		134TA5495
	38	42	358	80	420		124TA7230
	38	42	360	65	335		134TA5961
	38	42	370	80	315	180	105TA6920
	38	42	420	70	365	225	105TA7198
	38	42	565	80	558		108TA4470
	38	42	905	70	840		134TA5671
	38	42	910	82	842		105TA6866
	38	43	140	80	100		134TA5981
	38	43	390	170	230		105TA7256
	41	46	180	90	150		139TA4028

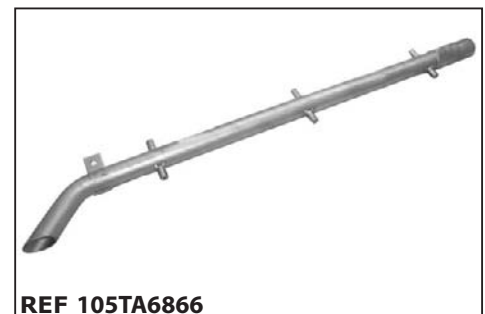

EXHAUST TUBES

For all our latest catalogue updates and company info: www.tvh.com

EXHAUST TUBES

used for: **mitsubishi-caterpillar**

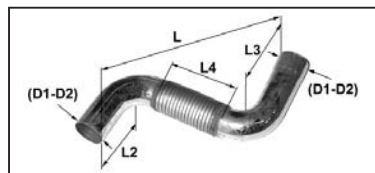

Number of bends AT-BO	Smallest outer dia. tube (mm) D1	Largest outer dia. tube (mm) D2	Dimension (mm) L	Dimension (mm) L2	Dimension (mm) L3	Dimension (mm) L4	REF
1	42	42	420	20	22		105TA7448
	43	43	200	97	115		118TA1632
	43	47	233	30	200		105TA7455
	43	47	307	108	203		105TA7415
	43	52	915	52	890		139TA4029
	43	56	1020	110	1000		139TA4030
	44	50	1070	50	1035		139TA4031
	45	45	580	255	340		134TA5920
	45	48	330	180	310	160	139TA4032
	45	48	340	170	320	170	139TA4033
	45	50	285	115	350		134TA6185
	47	47	390	95	360	275	105TA7062

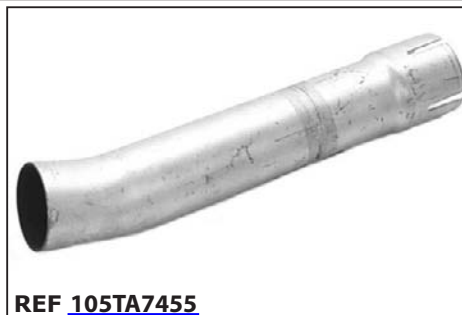

EXHAUST TUBES

For all our latest catalogue updates and company info: www.tvh.com



EXHAUST TUBES

used for: **MITSUBISHI-CATERPILLAR**

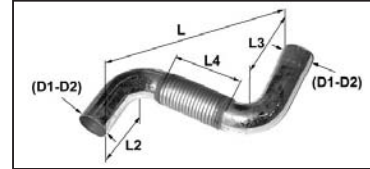

Number of bends	Smallest outer dia. tube (mm)	Largest outer dia. tube (mm)	Dimension (mm)	Dimension (mm)	Dimension (mm)	Dimension (mm)	REF
AT-BO	D1	D2	L	L2	L3	L4	
1	48	60	460	200	395	180	139TA4034
	49	54	340	35	300		105TA7185
	50	51	260	25	250	175	118TA1374
	50	52	895	40	870		134TA6032
	50	57	770	70	164	750	108TA4474
	50	58	1135	30	1100		139TA4035
	51	53	895	262	695		108TA4404
	51	55	83	33	50		108TA4529
	53	55	1067	75	1030		123TA6015
	57	61	270	37	280	100	139TA4036
	62	63	925	60	880		118TA1569
	62	64	207	100	140		108TA4442

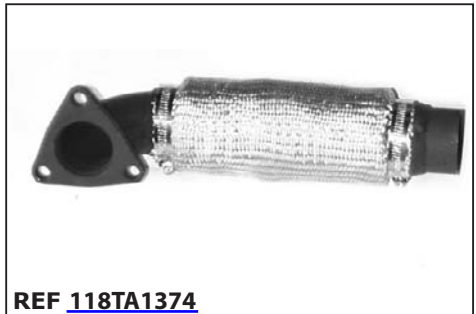

EXHAUST TUBES

For all our latest catalogue updates and company info: www.tvh.com

used for: **MITSUBISHI-CATERPILLAR**

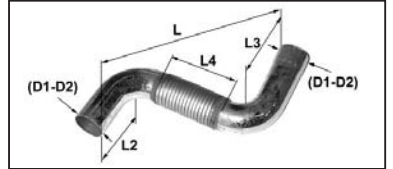

EXHAUST TUBES

Number of bends AT-BO	Smallest outer dia. tube (mm) D1	Largest outer dia. tube (mm) D2	Dimension (mm) L	Dimension (mm) L2	Dimension (mm) L3	Dimension (mm) L4	REF
1	62	64	225	70	180		105TA7357
	63	63	143	60	85		108TA4449
	63	67	225	115	160		139TA4037
	63	67	685	140	620	320	105TA7237
	63	67	760	30	715		134TA5882
	64	64	142	60	115		139TA4038
	69	69	404	85	380	275	118TA1570
	76	76	175	85	140		134TA5925
	88	88	165	75	115		108TA4514
	89	89	245	120	160		105TA7159
	90	90	410	65	400	270	105TA7240
2	35	38	515	100	130		139TA4039



REF [105TA7357](#)



REF [108TA4449](#)



REF [139TA4037](#)



REF [105TA7237](#)



REF [134TA5882](#)



REF [139TA4038](#)



REF [118TA1570](#)



REF [134TA5925](#)



REF [108TA4514](#)



REF [105TA7159](#)



REF [105TA7240](#)



REF [139TA4039](#)

EXHAUST TUBES

For all our latest catalogue updates and company info: www.tvh.com



EXHAUST TUBES

used for: **MITSUBISHI-CATERPILLAR**

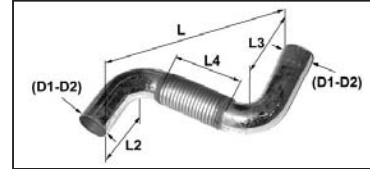

Number of bends AT-BO	Smallest outer dia. tube (mm) D1	Largest outer dia. tube (mm) D2	Dimension (mm) L	Dimension (mm) L2	Dimension (mm) L3	Dimension (mm) L4	REF
2	35	38	645	115	160		139TA4040
	35	39	650	105	170		139TA4041
	37	38	430	50	115	240	134TA6101
	38	38	265	35	110		105TA6890
	38	38	270	60	110		123TA6582
	38	38	580	180	230		105TA7082
	38	42	545	65	370		105TA7281
	38	43	420	70	175	166	139TA4042
	38	55	190	40	90		105TA7065
	38	55	300	65	115		124TA5153
	38	55	315	65	135		105TA6877
	39	54	180	46	77		118TA1631



EXHAUST TUBES

For all our latest catalogue updates and company info: www.tvh.com

EXHAUST TUBES

used for: **MITSUBISHI-CATERPILLAR**

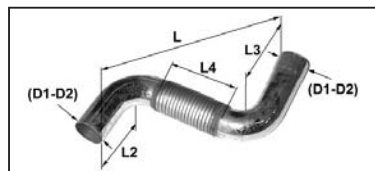

Number of bends AT-BO	Smallest outer dia. tube (mm) D1	Largest outer dia. tube (mm) D2	Dimension (mm) L	Dimension (mm) L2	Dimension (mm) L3	Dimension (mm) L4	REF
2	41	41	260	65	120	130	105TA6892
	41	45	208	65	75		108TA4454
	42	42	615	65	360		139TA4043
	42	44	565	70	520		105TA7241
	43	43	415	105	195		105TA7390
	43	43	425	110	200		105TA7097
	43	43	435	65	210		134TA5832
	43	43	472	70	220		139TA4044
	44	45	545	50	200	110	139TA4045
	45	45	330	90	280	145	139TA4046
	45	45	555	95	370	200	139TA4047
	45	45	560	95	345	230	139TA4048



REF [105TA6892](#)



REF [108TA4454](#)



REF [139TA4043](#)



REF [105TA7241](#)



REF [105TA7390](#)

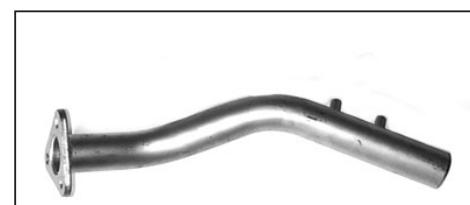

REF [105TA7097](#)



REF [134TA5832](#)



REF [139TA4044](#)



REF [139TA4045](#)



REF [139TA4046](#)

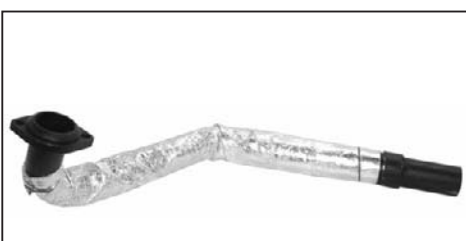

REF [139TA4047](#)



REF [139TA4048](#)

EXHAUST TUBES

For all our latest catalogue updates and company info: www.tvh.com



EXHAUST TUBES

used for: **MITSUBISHI-CATERPILLAR**

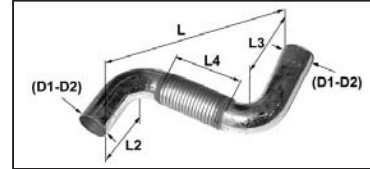

Number of bends	Smallest outer dia. tube (mm)	Largest outer dia. tube (mm)	Dimension (mm)	Dimension (mm)	Dimension (mm)	Dimension (mm)	REF
AT-BO	D1	D2	L	L2	L3	L4	
2	45	47	475	125	305	130	139TA4049
	45	48	450	70	175	52	139TA4050
	45	49	215	55	60		123TA6583
	45	49	218	50	60		124TA2097
	50	50	250	75	90		105TA6981
	50	50	395	25	315	175	134TA5928
	50	50	400	33	125	160	105TA7066
	50	50	445	65	95	280	105TA7006
	50	51	1130	45	70		105TA7319
	50	55	240	70	105		105TA7101
	50	55	795	130	195		105TA7035
	51	51	380	240	400	210	123TA6585



EXHAUST TUBES

For all our latest catalogue updates and company info: www.tvh.com

used for: **MITSUBISHI-CATERPILLAR**

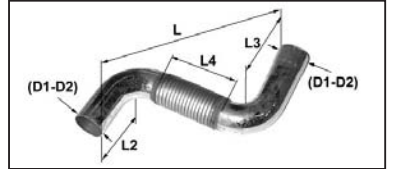

EXHAUST TUBES

Number of bends AT-BO	Smallest outer dia. tube (mm) D1	Largest outer dia. tube (mm) D2	Dimension (mm) L	Dimension (mm) L2	Dimension (mm) L3	Dimension (mm) L4	REF
2	51	51	420	245	405	210	123TA6586
	51	51	470	50	130	230	118TA1662
	51	51	500	100	105		118TA1616
	51	52	375	25	45	170	105TA7129
	51	54	65	41	46		123TA6587
	51	54	540	140	460		134TA6249
	51	55	677	240	450		123TA6584
	52	55	200	40	215		105TA7088
	52	57	1090	65	140		124TA5148
	57	64	650	70	168	390	105TA6896
	59	60	290	70	76		134TA5642
	76	76	305	40	120		105TA7140

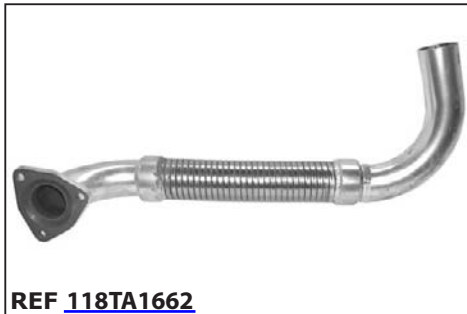

EXHAUST TUBES

For all our latest catalogue updates and company info: www.tvh.com



EXHAUST TUBES

used for: **MITSUBISHI-CATERPILLAR**

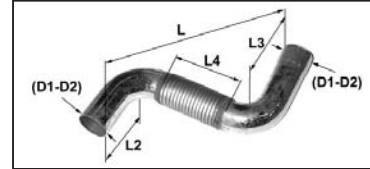

Number of bends AT-BO	Smallest outer dia. tube (mm) D1	Largest outer dia. tube (mm) D2	Dimension (mm) L	Dimension (mm) L2	Dimension (mm) L3	Dimension (mm) L4	REF
3	34	35	240	10	43		139TA4051
	34	36	395	95	165	138	134TA5673
	34	40	267	5	50		139TA4052
	35	48	580	70	113		139TA4053
	36	42	354	60	105		134TA5732
	37	38	440	40	85		108TA4457
	37	42	350	60	100		139TA4054
	38	38	310	47	104		123TA6588
	38	38	313	50	82		108TA4512
	38	38	320	50	100		105TA7423
	38	38	330	70	100		105TA7388
	38	38	650	70	120		139TA4055



EXHAUST TUBES

For all our latest catalogue updates and company info: www.tvh.com

used for: **MITSUBISHI-CATERPILLAR**

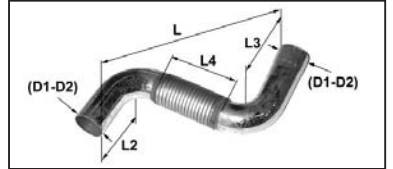

EXHAUST TUBES

Number of bends AT-BO	Smallest outer dia. tube (mm) D1	Largest outer dia. tube (mm) D2	Dimension (mm) L	Dimension (mm) L2	Dimension (mm) L3	Dimension (mm) L4	REF
3	38	39	370	50	100		105TA7013
	38	42	305	75	85		134TA6335
	38	42	390	110	120		134TA6286
	38	42	438	100	125		134TA6238
	38	45	575	80	240	140	139TA4056
	39	42	285	68	110		139TA4057
	40	40	390	45	95		134TA5935
	40	48	565	66	95		139TA4058
	41	45	360	73	150	150	139TA4059
	41	45	509	220	225		108TA4455
	41	47	415	60	100		139TA4060
	42	42	353	30	148		108TA8890

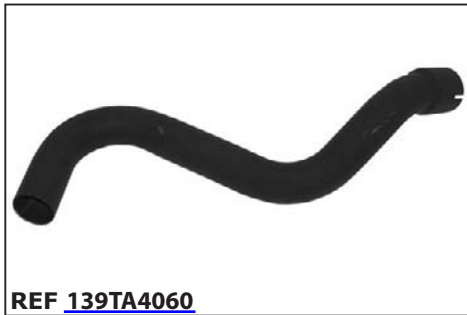

EXHAUST TUBES

For all our latest catalogue updates and company info: www.tvh.com



EXHAUST TUBES

used for: **MITSUBISHI-CATERPILLAR**

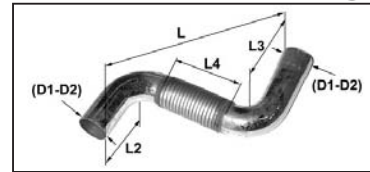

Number of bends AT-BO	Smallest outer dia. tube (mm) D1	Largest outer dia. tube (mm) D2	Dimension (mm) L	Dimension (mm) L2	Dimension (mm) L3	Dimension (mm) L4	REF
3	42	49	330	27	75		139TA4061
	43	43	425	80	90	140	134TA5547
	43	43	525	80	110		139TA4062
	43	45	335	25	250	165	106TA5021
	43	47	275	70	265		139TA4063
	44	44	620	50	330	230	139TA4064
	45	45	590	45	275	135	139TA4065
	45	45	640	75	295	125	139TA4066
	45	48	340	60	105		139TA4067
	47	48	510	90	100		139TA4068
	50	50	360	75	100		134TA5734
	50	50	550	90	100	165	106TA7350



EXHAUST TUBES

For all our latest catalogue updates and company info: www.tvh.com

used for: **MITSUBISHI-CATERPILLAR**

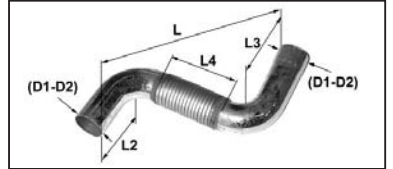

EXHAUST TUBES

Number of bends AT-BO	Smallest outer dia. tube (mm) D1	Largest outer dia. tube (mm) D2	Dimension (mm) L	Dimension (mm) L2	Dimension (mm) L3	Dimension (mm) L4	REF
3	50	51	560	105	230	275	108TA4519
	50	55	450	105	120		105TA6947
	51	51	610	35	75	410	108TA4536
	51	51	655	115	215		105TA7203
	51	53	405	50	85		105TA7437
	51	54	155	40	60		134TA5887
	51	54	450	60	90		118TA1547
	51	55	370	50	90		105TA7269
	53	66	545	130	320	170	134TA5682
	57	60	620	70	195		139TA4069
	57	65	692	64	167	380	105TA6905
	59	65	865	145	190	255	134TA5633

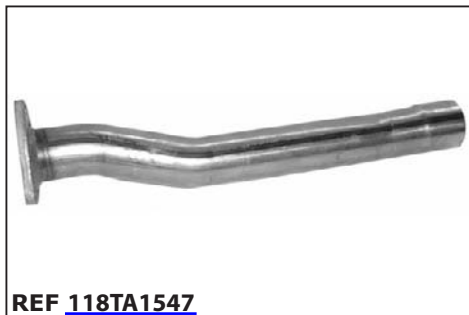

EXHAUST TUBES

For all our latest catalogue updates and company info: www.tvh.com



EXHAUST TUBES

used for: **MITSUBISHI-CATERPILLAR**

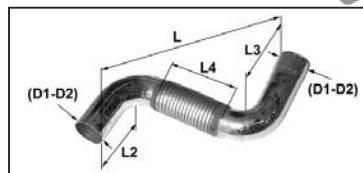

Number of bends AT-BO	Smallest outer dia. tube (mm) D1	Largest outer dia. tube (mm) D2	Dimension (mm) L	Dimension (mm) L2	Dimension (mm) L3	Dimension (mm) L4	REF
3	62	62	540	100	140		139TA4070
	65	64	588	130	200		139TA4071
	76	76	423	90	380		139TA4072
	80	102	295	90	195		134TA6291
4	35	35	605	105	140		139TA4073
	38	38	560	95	115	150	134TA5626
	38	46	390	45	55	150	118TA1465
	39	38	363	55	65	110	134TA5617
	43	43	470	35	110		134TA5836
	43	47	740	70	265		105TA7244
	47	48	670	60	80		139TA4074
	48	48	500	65	80		139TA4075



EXHAUST TUBES

For all our latest catalogue updates and company info: www.tvh.com

used for: **MITSUBISHI-CATERPILLAR**

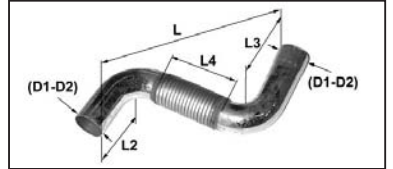

EXHAUST TUBES

Number of bends AT-BO	Smallest outer dia. tube (mm) D1	Largest outer dia. tube (mm) D2	Dimension (mm) L	Dimension (mm) L2	Dimension (mm) L3	Dimension (mm) L4	REF
4	50	50	325	150	350	175	105TA6968
	50	52	480	40	90		105TA7134
	51	51	550	100	195		110TA8593
	51	52	840	100	335		139TA4076
	61	63	630	105	120		105TA7213
5	35	35	605	70	70		139TA4077
	38	38	570	80	280	135	134TA6114
	38	38	835	110	240		105TA6898
	38	42	1235	25	200		134TA6026
	39	43	1145	50	80		134TA6343
	39	47	510	80	260	140	139TA4078
	39	47	530	35	90	135	139TA4079



EXHAUST TUBES

For all our latest catalogue updates and company info: www.tvh.com



EXHAUST TUBES

used for: **mitsubishi-caterpillar**

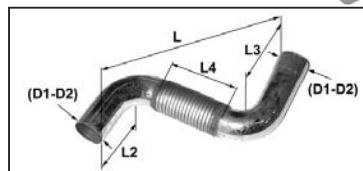

Number of bends AT-BO	Smallest outer dia. tube (mm) D1	Largest outer dia. tube (mm) D2	Dimension (mm) L	Dimension (mm) L2	Dimension (mm) L3	Dimension (mm) L4	REF
5	40	42	680	120	273	150	139TA4080
	44	49	1345	40	50		139TA4081
	51	54	970	85	120		134TA5990
	61	61	1140	100	180		139TA4082
6	42	42	750	70	70	150	134TA5624
	43	47	640	120	120	150	134TA5834



Look up these parts via

EXHAUST TUBES

For all our latest catalogue updates and company info: www.tvh.com

used for: **MOFFETT**

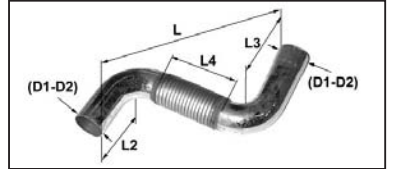

EXHAUST TUBES

Number of bends AT-BO	Smallest outer dia. tube (mm) D1	Largest outer dia. tube (mm) D2	Dimension (mm) L	Dimension (mm) L2	Dimension (mm) L3	Dimension (mm) L4	REF
1	35	35	102	32	74		134TA6050
	40	41	475	20	470	105	139TA4083
	42	43	150	32	147		134TA5977
2	41	45	515	30	350	155	134TA6351
	42	42	235	30	135		134TA6021
	42	42	252	25	80		134TA5641
	43	51	560	60	420		134TA6055
	50	48	260	35	95		134TA6077
4	35	35	565	60	180		139TA4084
5	37	39	790	40	90		139TA4085



EXHAUST TUBES

For all our latest catalogue updates and company info: www.tvh.com

EXHAUST TUBES

used for: **NISSAN**

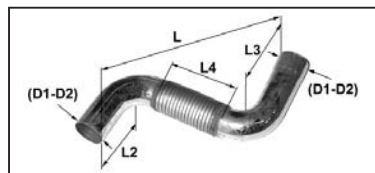

Number of bends AT-BO	Smallest outer dia. tube (mm) D1	Largest outer dia. tube (mm) D2	Dimension (mm) L	Dimension (mm) L2	Dimension (mm) L3	Dimension (mm) L4	REF
0	38	42	246				118TA1575
	41	46	313				134TA5804
	45	47	253				134TA6107
	46	46	250				105TA6895
1	35	38	122	53	87		123TA6700
	36	38	75	26	52		123TA6701
	38	38	205	10	195		105TA6980
	38	38	335	115	270		105TA6894
	38	42	200	130	150		139TA4086
	38	42	257	160	180		134TA5996
	38	42	310	110	285		105TA6912
	38	42	865				124TA7247



REF [118TA1575](#)



REF [134TA5804](#)



REF [134TA6107](#)



REF [105TA6895](#)



REF [123TA6700](#)



REF [123TA6701](#)



REF [105TA6980](#)



REF [105TA6894](#)



REF [139TA4086](#)



REF [134TA5996](#)

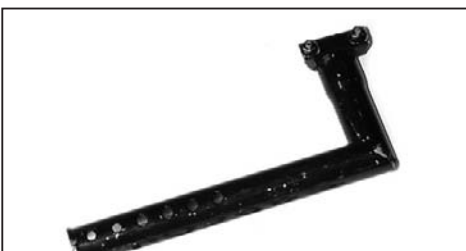

REF [105TA6912](#)



REF [124TA7247](#)

EXHAUST TUBES

For all our latest catalogue updates and company info: www.tvh.com



EXHAUST TUBES

used for: **NISSAN**

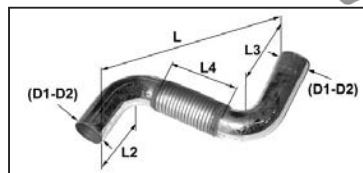

Number of bends	Smallest outer dia. tube (mm)	Largest outer dia. tube (mm)	Dimension (mm)	Dimension (mm)	Dimension (mm)	Dimension (mm)	REF
AT-BO	D1	D2	L	L2	L3	L4	
1	38	47	174	80	110		123TA6702
	38	47	180	95	110		134TA5821
	42	38	300	85	290		134TA5843
	44	48	205	115	130		124TA1025
	45	45	215	54	170	70	124TA1028
	45	50	242	90	190		134TA5615
	46	46	140	20	125		124TA1029
	50	57	258	150	170		108TA4391
	53	53	260	165	165		105TA6881
	70	70	390	195	230		105TA7189
	2	35	38	537	122	470	
35		40	375	105	130		134TA5939



EXHAUST TUBES

For all our latest catalogue updates and company info: www.tvh.com

EXHAUST TUBES

used for: **NISSAN**

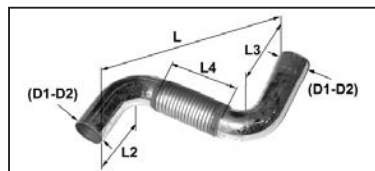

Number of bends AT-BO	Smallest outer dia. tube (mm) D1	Largest outer dia. tube (mm) D2	Dimension (mm) L	Dimension (mm) L2	Dimension (mm) L3	Dimension (mm) L4	REF
2	36	38	250	35	90		123TA6703
	38	38	395	85	200		134TA5744
	38	42	245	110	155		105TA7128
	38	42	365	115	185		139TA4087
	38	42	405	130	245		124TA1065
	38	43	440	50	120	210	134TA6169
	39	41	250	80	150		134TA5997
	40	41	425	255	265		105TA7162
	40	45	540	250	280		134TA5963
	42	42	350	105	255		105TA6982
	42	42	515	150	205		105TA6878
	42	44	424	60	250		124TA1041



EXHAUST TUBES

For all our latest catalogue updates and company info: www.tvh.com



EXHAUST TUBES

used for: **NISSAN**

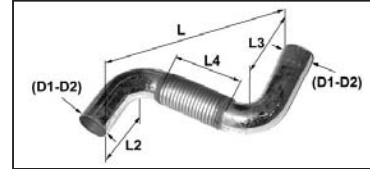

Number of bends AT-BO	Smallest outer dia. tube (mm) D1	Largest outer dia. tube (mm) D2	Dimension (mm) L	Dimension (mm) L2	Dimension (mm) L3	Dimension (mm) L4	REF
2	42	46	416	90	225		134TA5735
	42	46	425	160	210		124TA1081
	42	46	495	125	255		124TA2863
	42	46	542	130	250		134TA5739
	43	43	435	65	210		134TA5833
	44	44	230	35	100		124TA1032
	44	48	467	160	240		139TA4088
	45	56	560	160	230		139TA4089
	47	47	420	150	225		110TA9674
	47	47	467	145	230		108TA4407
	51	51	187	30	110		123TA6704
	52	57	1090	65	140		124TA5146



EXHAUST TUBES

For all our latest catalogue updates and company info: www.tvh.com

EXHAUST TUBES

used for: **NISSAN**

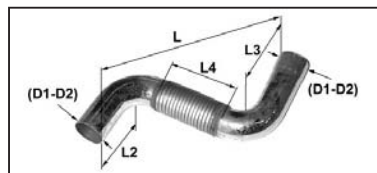

Number of bends AT-BO	Smallest outer dia. tube (mm) D1	Largest outer dia. tube (mm) D2	Dimension (mm) L	Dimension (mm) L2	Dimension (mm) L3	Dimension (mm) L4	REF
2	54	58	645	87	225		118TA1651
	55	80	1038	150	268		108TA4392
	61	66	310	45	50		123TA6705
	64	64	405	50	245		123TA6706
3	35	35	480	30	50		118TA1599
	37	38	680	60	235	70	139TA4090
	37	38	765	60	330	70	139TA4091
	38	38	380	85	155		105TA7096
	38	38	1160	20	140		105TA7202
	38	42	330	75	80		105TA7034
	38	42	550	110	175		134TA5897
	38	42	730	80	150		105TA6928



REF [118TA1651](#)



REF [108TA4392](#)



REF [123TA6705](#)



REF [123TA6706](#)



REF [118TA1599](#)



REF [139TA4090](#)



REF [139TA4091](#)



REF [105TA7096](#)



REF [105TA7202](#)



REF [105TA7034](#)



REF [134TA5897](#)



REF [105TA6928](#)

EXHAUST TUBES

For all our latest catalogue updates and company info: www.tvh.com



EXHAUST TUBES

used for: **NISSAN**

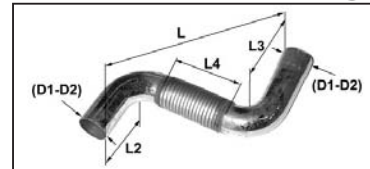

Number of bends AT-BO	Smallest outer dia. tube (mm) D1	Largest outer dia. tube (mm) D2	Dimension (mm) L	Dimension (mm) L2	Dimension (mm) L3	Dimension (mm) L4	REF
3	42	42	520	160	260		134TA6239
	42	42	535	160	215		105TA6879
	42	42	560	145	320		105TA7080
	42	42	775	90	160		106TA5019
	45	45	100	60	520		105TA7218
	53	54	470	125	215		105TA7243
	54	59	695	200	360		118TA1527
4	38	41	645	65	70		105TA7031
	38	41	785	120	140		134TA5988
	38	41	830	90	250		139TA4092
	38	42	755	133	160		105TA6880
	39	41	495	60	100		134TA5748



EXHAUST TUBES

For all our latest catalogue updates and company info: www.tvh.com

used for: **NISSAN**

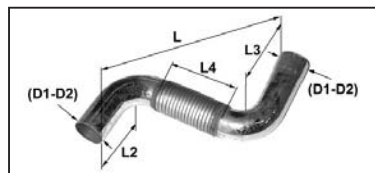

EXHAUST TUBES

Number of bends AT-BO	Smallest outer dia. tube (mm) D1	Largest outer dia. tube (mm) D2	Dimension (mm) L	Dimension (mm) L2	Dimension (mm) L3	Dimension (mm) L4	REF
4	39	43	550	55	90		123TA6707
	40	40	530	40	90		134TA5964
	41	41	550	55	70	190	123TA6708
	42	42	400	65	95		134TA6201
	42	42	495	35	85		139TA4093
	42	42	750	130	145		105TA7168
	42	42	800	120	160		123TA6709
	42	42	825	140	160		134TA6341
	42	43	570	140	200		105TA7252
	42	47	297	45	59	130	108TA4397
	43	43	470	35	110		134TA5837
	43	47	500	80	100		123TA6710



EXHAUST TUBES

For all our latest catalogue updates and company info: www.tvh.com



EXHAUST TUBES

used for: **NISSAN**

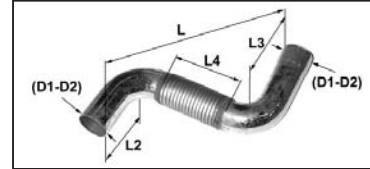

Number of bends	Smallest outer dia. tube (mm)	Largest outer dia. tube (mm)	Dimension (mm)	Dimension (mm)	Dimension (mm)	Dimension (mm)	REF
AT-BO	D1	D2	L	L2	L3	L4	
4	45	50	545	70	148		118TA1649
	50	52	480	40	90		123TA6711
	50	54	860	30	85		134TA6135
	50	54	865	50	90		105TA6951
	54	61	880	325	470		108TA4473
5	35	47	680	75	100		134TA5979
	40	43	530	80	280	140	134TA5842
	41	41	650	75	80		105TA7447
	42	42	365	60	80	125	105TA7261
	44	51	470	60	70		124TA1035
	50	54	430	90	145		105TA6885
6	38	41	605	65	70		110TA9696



EXHAUST TUBES

For all our latest catalogue updates and company info: www.tvh.com

EXHAUST TUBES

used for: **NISSAN**

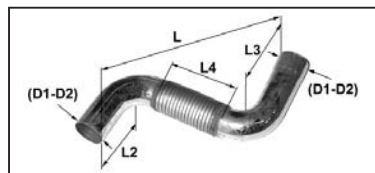

Number of bends AT-BO	Smallest outer dia. tube (mm) D1	Largest outer dia. tube (mm) D2	Dimension (mm) L	Dimension (mm) L2	Dimension (mm) L3	Dimension (mm) L4	REF
6	42	47	620	55	75		134TA5959
	43	43	910	90	140		134TA6207
	43	47	640	120	120	150	134TA5835
	47	40	605	75	75		134TA5958



Look up these parts via

EXHAUST TUBES

For all our latest catalogue updates and company info: www.tvh.com



EXHAUST TUBES

used for: **OM PIMESPO**

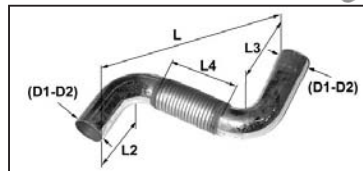

Number of bends AT-BO	Smallest outer dia. tube (mm) D1	Largest outer dia. tube (mm) D2	Dimension (mm) L	Dimension (mm) L2	Dimension (mm) L3	Dimension (mm) L4	REF
0	34	38	99				139TA4094
	42	45	315			215	139TA4095
	46	46	270				139TA4096
	49	49	780				134TA6130
	53	53	190				139TA4097
	58	58	110				139TA4098
1	38	64	870	90	800		139TA4099
	39	43	190	105	130		139TA4100
	42	42	328	75	255	140	139TA4101
	43	43	200	110	135		139TA4102
	43	46	615	245	395	250	139TA4103
	43	47	315	80	280		139TA4104

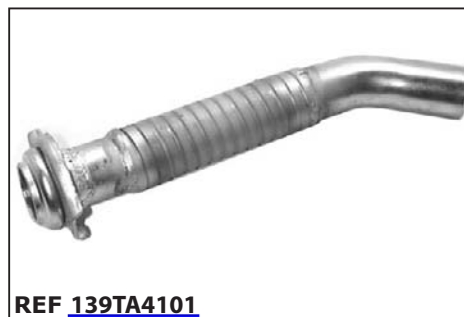

EXHAUST TUBES

For all our latest catalogue updates and company info: www.tvh.com

EXHAUST TUBES

used for: **OM PIMESPO**

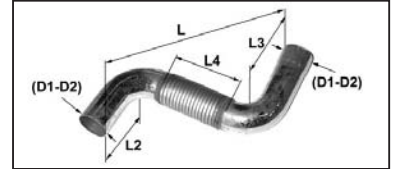

Number of bends AT-BO	Smallest outer dia. tube (mm) D1	Largest outer dia. tube (mm) D2	Dimension (mm) L	Dimension (mm) L2	Dimension (mm) L3	Dimension (mm) L4	REF
1	44	49	926	80	900		108TA4385
	45	45	850	115	806		106TA6246
	45	48	1620	45	1600		104TA5988
	45	50	925	94	905		118TA1535
	45	55	784	170	620	300	139TA4105
	45	57	890	65	880	640	139TA4106
	48	50	215	80	175		105TA7075
	48	50	770	85	740		134TA6071
	50	50	153	100	100		134TA6261
	50	50	155	125	310	160	134TA5954
	50	54	200	75	165		105TA7048
	50	55	840	90	800		124TA1075

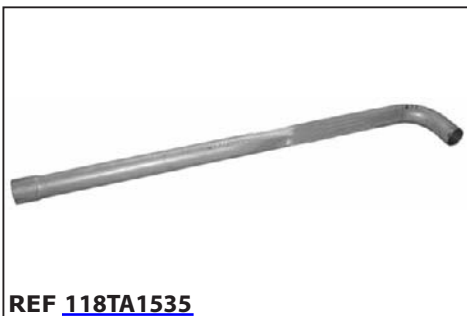

EXHAUST TUBES

For all our latest catalogue updates and company info: www.tvh.com



EXHAUST TUBES

used for: **OM PIMESPO**

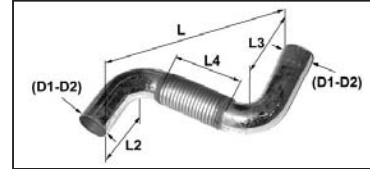

Number of bends	Smallest outer dia. tube (mm)	Largest outer dia. tube (mm)	Dimension (mm)	Dimension (mm)	Dimension (mm)	Dimension (mm)	REF
AT-BO	D1	D2	L	L2	L3	L4	
1	50	55	845	75	820		105TA7215
	51	56	975	400	600		139TA4107
	55	55	1405	40	138		134TA5759
	60	60	225	80	150		139TA4108
	70	70	365	105	325	210	105TA7136
2	25	26	160	42	18		124TA1044
	34	37	270	95	120		139TA4109
	36	36	150	35	45		134TA6152
	38	43	410	150	360	150	139TA4110
	40	40	460	87	280		134TA6122
	40	41	500	140	285		105TA7327
	41	48	420	80	85	140	139TA4111



EXHAUST TUBES

For all our latest catalogue updates and company info: www.tvh.com

used for: **OM PIMESPO**

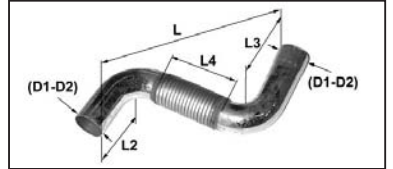

EXHAUST TUBES

Number of bends AT-BO	Smallest outer dia. tube (mm) D1	Largest outer dia. tube (mm) D2	Dimension (mm) L	Dimension (mm) L2	Dimension (mm) L3	Dimension (mm) L4	REF
2	42	47	370	60	70	210	139TA4112
	43	43	327	55	240		139TA4113
	43	47	255	65	85		139TA4114
	43	47	475	100	155	175	139TA4115
	44	45	340	65	115		105TA7085
	44	46	390	150	180	240	134TA6229
	44	51	500	70	125		139TA4116
	44	58	825	40	745	390	139TA4117
	45	50	800	120	265	110	139TA4118
	45	54	1010	90	105	75	139TA4119
	47	50	440	90	250		139TA4120
	49	51	655	55	395	290	134TA6000



EXHAUST TUBES

For all our latest catalogue updates and company info: www.tvh.com



EXHAUST TUBES

used for: **OM PIMESPO**

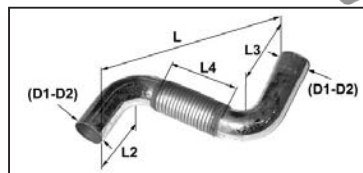

Number of bends	Smallest outer dia. tube (mm)	Largest outer dia. tube (mm)	Dimension (mm)	Dimension (mm)	Dimension (mm)	Dimension (mm)	REF
AT-BO	D1	D2	L	L2	L3	L4	
2	49	56	260	35	50		134TA6258
	50	50	390	80	290		134TA5782
	50	51	320	35	80		134TA6145
	50	51	595	70	400	285	139TA4121
	50	55	480	50	415	210	134TA5753
	51	51	645	55	400	285	124TA1054
	51	53	590	60	405	200	134TA5714
	51	55	445	45	120		123TA6615
	51	55	685	60	410	210	123TA6616
	54	54	300	110	170		134TA6118
	54	76	350	45	125	220	139TA4122
3	34	35	400	80	290	110	139TA4123

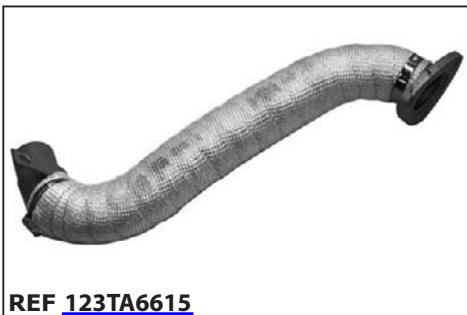

EXHAUST TUBES

For all our latest catalogue updates and company info: www.tvh.com

EXHAUST TUBES

used for: **OM PIMESPO**

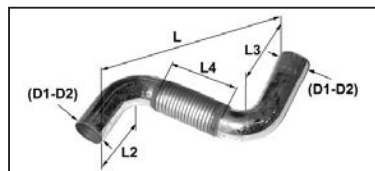

Number of bends AT-BO	Smallest outer dia. tube (mm) D1	Largest outer dia. tube (mm) D2	Dimension (mm) L	Dimension (mm) L2	Dimension (mm) L3	Dimension (mm) L4	REF
3	37	40	565	37	75	150	139TA4124
	38	42	390	85	105	140	139TA4125
	38	47	470	70	90	130	139TA4126
	41	43	490	95	192	145	139TA4127
	42	42	400	95	105		139TA4128
	42	46	358	45	50	178	139TA4129
	42	47	440	45	95	175	139TA4130
	43	43	425	80	90	140	139TA4131
	43	44	580	40	70	310	105TA6937
	43	46	420	75	125	150	139TA4132
	43	47	515	65	255	160	139TA4133
	44	45	405	20	170	230	105TA7032

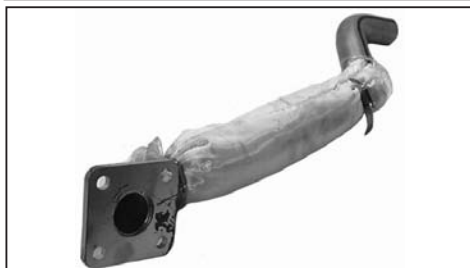

REF [139TA4124](#)



REF [139TA4125](#)



REF [139TA4126](#)

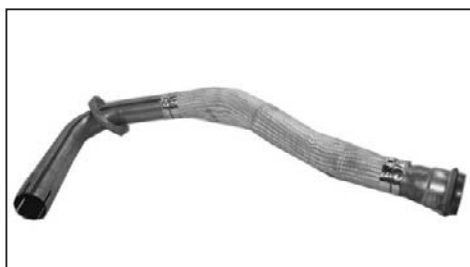

REF [139TA4127](#)



REF [139TA4128](#)

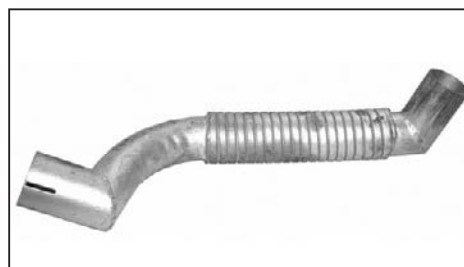

REF [139TA4129](#)



REF [139TA4130](#)



REF [139TA4131](#)



REF [105TA6937](#)



REF [139TA4132](#)

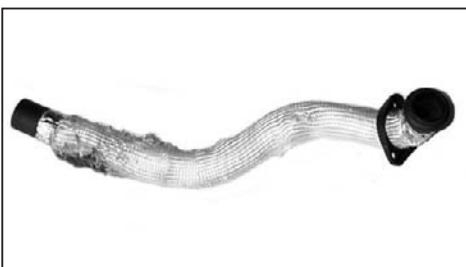

REF [139TA4133](#)



REF [105TA7032](#)

EXHAUST TUBES

For all our latest catalogue updates and company info: www.tvh.com



EXHAUST TUBES

used for: **OM PIMESPO**

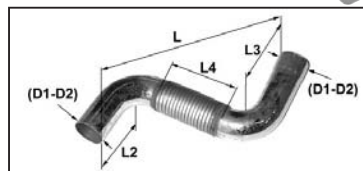

Number of bends AT-BO	Smallest outer dia. tube (mm) D1	Largest outer dia. tube (mm) D2	Dimension (mm) L	Dimension (mm) L2	Dimension (mm) L3	Dimension (mm) L4	REF
3	44	49	380	33	50	240	134TA6247
	45	45	525	40	115	345	134TA6251
	45	50	330	55	70		139TA4134
	45	51	600	255	450		139TA4135
	45	51	700	20	195	100	139TA4136
	45	52	722	25	250	160	139TA4137
	46	46	440	40	150		134TA6125
	47	49	530	55	95	135	134TA6339
	47	51	335	40	70		105TA6956
	49	49	510	100	100	130	139TA4138
	50	80	885	110	210	100	139TA4139
	51	51	370	40	200		139TA4140



EXHAUST TUBES

For all our latest catalogue updates and company info: www.tvh.com

used for: **OM PIMESPO**

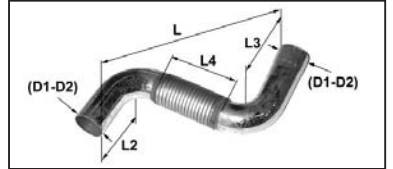

EXHAUST TUBES

Number of bends AT-BO	Smallest outer dia. tube (mm) D1	Largest outer dia. tube (mm) D2	Dimension (mm) L	Dimension (mm) L2	Dimension (mm) L3	Dimension (mm) L4	REF
3	51	51	705	110	125	115	139TA4141
	51	54	883	110	125	110	139TA4142
	54	60	590	70	95	160	134TA5808
	70	70	865	100	730	200	139TA4143
4	34	38	630	130	160	110	139TA4144
	34	43	575	15	105	155	139TA4145
	35	42	280	65	125	150	139TA4146
	38	39	355	65	135		139TA4147
	38	41	570	150	180		139TA4148
	38	41	595	70	170	145	139TA4149
	38	45	430	60	60		105TA7216
	39	42	705	65	145		139TA4150

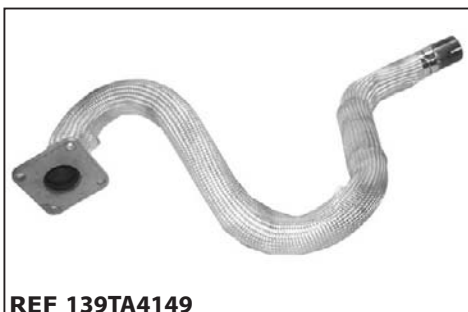

EXHAUST TUBES

For all our latest catalogue updates and company info: www.tvh.com



EXHAUST TUBES

used for: **OM PIMESPO**

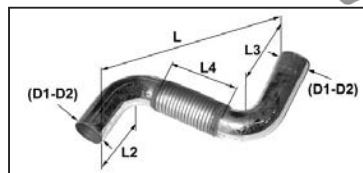

Number of bends AT-BO	Smallest outer dia. tube (mm) D1	Largest outer dia. tube (mm) D2	Dimension (mm) L	Dimension (mm) L2	Dimension (mm) L3	Dimension (mm) L4	REF
4	42	42	300	60	100		139TA4151
	42	42	550	20	80		139TA4152
	42	43	460	95	115	160	139TA4153
	43	45	610	60	75	310	105TA7234
	43	48	455	60	130		139TA4154
	44	51	740	55	177	170	139TA4155
	44	51	747	50	180	105	139TA4156
	45	45	560	40	100	270	134TA6140
	45	45	570	70	80	260	110TA8607
	45	50	480	50	55	150	134TA5989
	45	50	525	80	80	120	134TA5756
	45	51	890	43	135	430	139TA4157

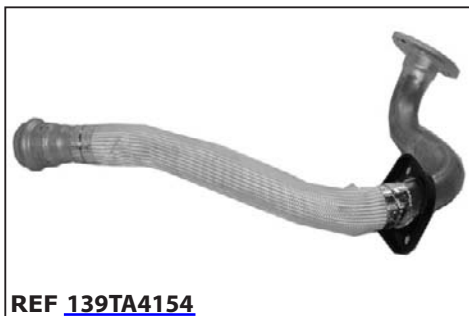

EXHAUST TUBES

For all our latest catalogue updates and company info: www.tvh.com

used for: **OM PIMESPO**

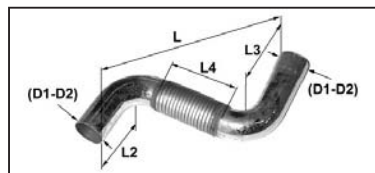

EXHAUST TUBES

Number of bends AT-BO	Smallest outer dia. tube (mm) D1	Largest outer dia. tube (mm) D2	Dimension (mm) L	Dimension (mm) L2	Dimension (mm) L3	Dimension (mm) L4	REF
4	48	51	720	35	276		139TA4158
	49	50	630	80	120	325	118TA1673
	50	50	700	40	40	380	118TA1587
	50	50	1010	30	200	240	139TA4159
	50	51	540	55	65	230	105TA7336
	51	51	920	70	170	150	139TA4160
	51	53	870	85	95	130	139TA4161
	56	57	695	28	95		139TA4162
5	33	33	515	60	115	155	139TA4163
	33	45	580	70	90	310	105TA7219
	34	34	575	75	120	165	139TA4164
	34	37	620	132	158	170	139TA4165

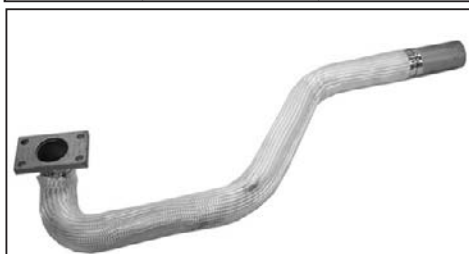

REF [139TA4158](#)



REF [118TA1673](#)



REF [118TA1587](#)



REF [139TA4159](#)



REF [105TA7336](#)



REF [139TA4160](#)



REF [139TA4161](#)



REF [139TA4162](#)



REF [139TA4163](#)

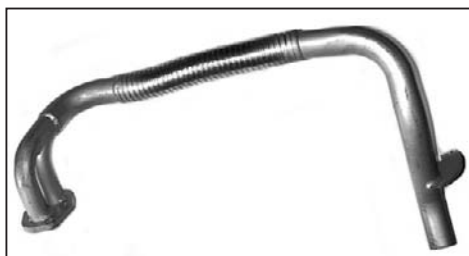

REF [105TA7219](#)



REF [139TA4164](#)

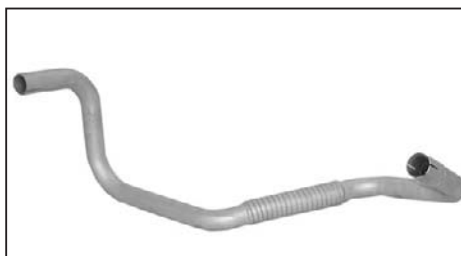

REF [139TA4165](#)

EXHAUST TUBES

For all our latest catalogue updates and company info: www.tvh.com



EXHAUST TUBES

used for: **OM PIMESPO**

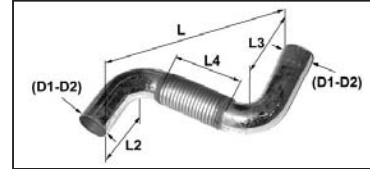

Number of bends AT-BO	Smallest outer dia. tube (mm) D1	Largest outer dia. tube (mm) D2	Dimension (mm) L	Dimension (mm) L2	Dimension (mm) L3	Dimension (mm) L4	REF
5	34	43	540	115	280	115	139TA4166
	34	63	476	25	120	163	139TA4167
	35	40	580	70	85	150	139TA4168
	35	45	785	20	60	340	105TA7217
	37	38	690	80	160		139TA4169
	38	38	135	7	54		139TA4170
	39	42	695	110	270	145	139TA4171
	40	40	705	85	200		139TA4172
	42	42	530	70	190		139TA4173
	43	43	645	20	235		139TA4174
	43	45	810	55	65	350	134TA6284
	44	45	445	45	65	300	134TA6024

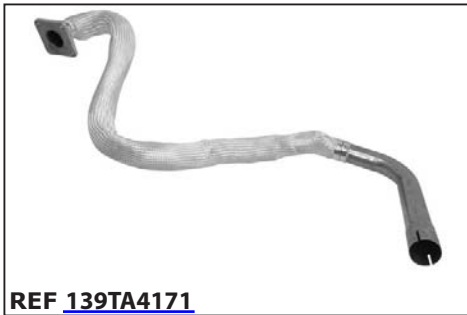

EXHAUST TUBES

For all our latest catalogue updates and company info: www.tvh.com

used for: **OM PIMESPO**

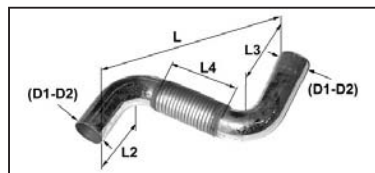

EXHAUST TUBES

Number of bends AT-BO	Smallest outer dia. tube (mm) D1	Largest outer dia. tube (mm) D2	Dimension (mm) L	Dimension (mm) L2	Dimension (mm) L3	Dimension (mm) L4	REF
5	45	45	780	55	80		139TA4175
	45	45	980	65	155	300	108TA4530
	50	50	660	45	45	305	105TA7339
	50	50	745	40	60	280	105TA7038
	51	51	780	30	220	200	139TA4176
	51	51	960	50	130	325	139TA4177
	55	64	790	35	60	200	139TA4178
6	34	34	630	70	275	105	139TA4179
	34	38	800	90	95	155	139TA4180
	43	43	470	53	55	180	139TA4181
	50	50	550	50	100	300	134TA6232
	50	50	660	45	65	270	105TA7186

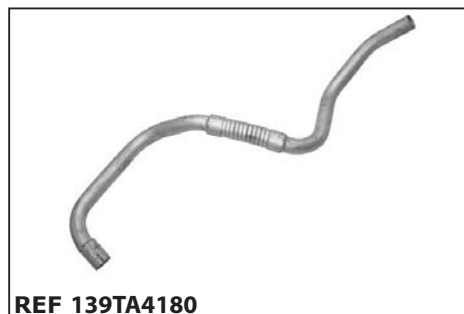
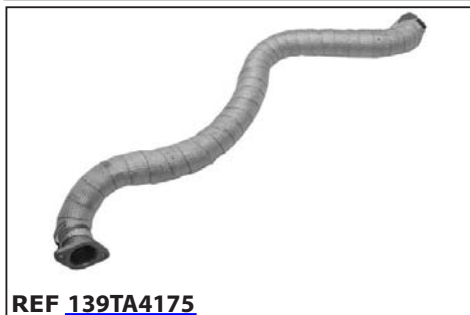

EXHAUST TUBES

For all our latest catalogue updates and company info: www.tvh.com

EXHAUST TUBES

used for: **OMG**

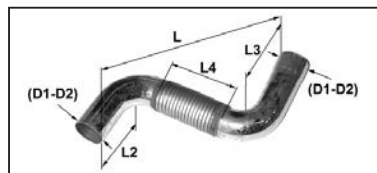

Number of bends AT-BO	Smallest outer dia. tube (mm) D1	Largest outer dia. tube (mm) D2	Dimension (mm) L	Dimension (mm) L2	Dimension (mm) L3	Dimension (mm) L4	REF
1	42	45	640	405	505	135	139TA4182
3	42	47	587	80	420	150	139TA4183
4	40	42	750	45	120	140	134TA5914
	41	42	410	35	75	135	134TA5918
	42	42	720	40	165	140	134TA5814
	42	57	730	125	130	170	134TA5659
	48	54	613	30	100	145	139TA4184
5	41	42	590	70	120	135	134TA5906
	42	42	550	50	125	130	134TA5910
	42	57	625	50	390	140	139TA4185



EXHAUST TUBES

For all our latest catalogue updates and company info: www.tvh.com



EXHAUST TUBES

used for: **PATRIA**

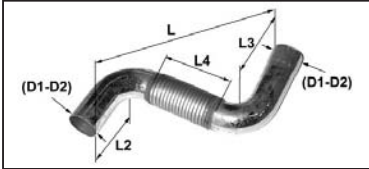

Number of bends AT-BO	Smallest outer dia. tube (mm) D1	Largest outer dia. tube (mm) D2	Dimension (mm) L	Dimension (mm) L2	Dimension (mm) L3	Dimension (mm) L4	REF
2	42	42	290	50	50		124TA2861
	42	42	300	52	60		124TA2862
3	41	41	530	85	115		139TA4186



EXHAUST TUBES

For all our latest catalogue updates and company info: www.tvh.com

EXHAUST TUBES

used for: **SALEV**

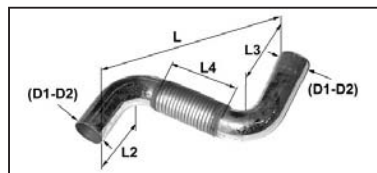

Number of bends AT-BO	Smallest outer dia. tube (mm) D1	Largest outer dia. tube (mm) D2	Dimension (mm) L	Dimension (mm) L2	Dimension (mm) L3	Dimension (mm) L4	REF
2	42	45	370	120	280	140	134TA6277
	43	48	340	70	170	95	134TA6321
	50	50	960	40	75	830	134TA5818
3	42	46	310	30	120	130	134TA6267
5	33	33	515	60	115	155	134TA5538
6	43	43	470	53	55	180	134TA5994



REF [134TA6277](#)



REF [134TA6321](#)



REF [134TA5818](#)



REF [134TA6267](#)



REF [134TA5538](#)

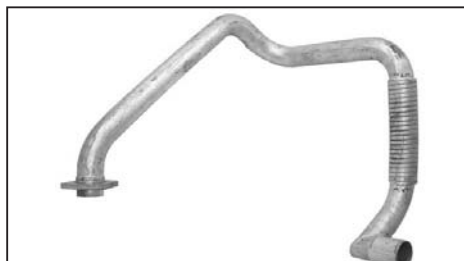

REF [134TA5994](#)

EXHAUST TUBES

For all our latest catalogue updates and company info: www.tvh.com

EXHAUST TUBES

used for: **STILL**

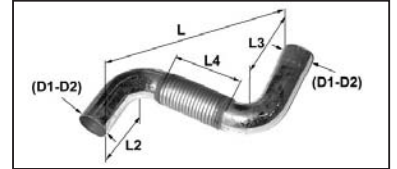

Number of bends AT-BO	Smallest outer dia. tube (mm) D1	Largest outer dia. tube (mm) D2	Dimension (mm) L	Dimension (mm) L2	Dimension (mm) L3	Dimension (mm) L4	REF
0	38	38	415			300	105TA7315
	38	45	420			285	105TA7195
	38	45	1030			905	105TA7225
	38	49	317			180	134TA5640
	51	53	200			110	139TA4189
	54	54	210			115	139TA4190
	54	59	240			105	139TA4191
	75	86	460				139TA4192
1	38	56	345	75	265	145	105TA7107
	40	41	1970	55	1925	1000	134TA5645
	40	46	1630	35	730	710	108TA4447
	40	46	1710	53	1680	825	118TA1629



EXHAUST TUBES

For all our latest catalogue updates and company info: www.tvh.com



EXHAUST TUBES

used for: **STILL**

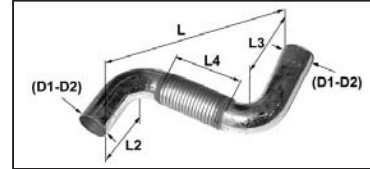

Number of bends AT-BO	Smallest outer dia. tube (mm) D1	Largest outer dia. tube (mm) D2	Dimension (mm) L	Dimension (mm) L2	Dimension (mm) L3	Dimension (mm) L4	REF
1	42	42	85	25	80		105TA7307
	42	42	235	70	180		139TA4193
	42	42	395	170	330		139TA4194
	42	42	472	460	40	410	106TA7380
	42	45	290	120	195		139TA4195
	42	46	315	205	215	105	139TA4196
	42	46	475	105	445		139TA4197
	48	50	215	80	175		123TA6713
	50	50	645	135	600	160	134TA5873
	50	54	115	60	68		110TA9618
	50	66	410	125	290	178	139TA4198
	51	51	155	175	200		118TA1600

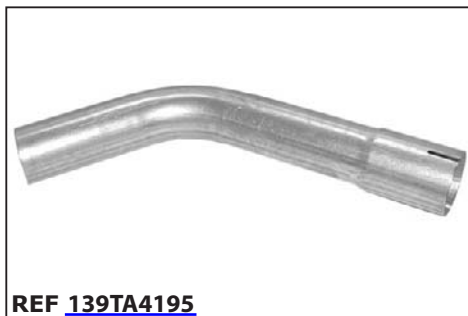

EXHAUST TUBES

For all our latest catalogue updates and company info: www.tvh.com

EXHAUST TUBES

used for: **STILL**

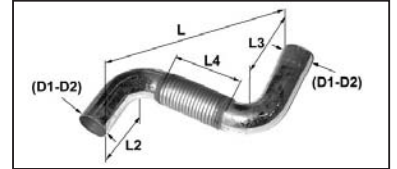

Number of bends AT-BO	Smallest outer dia. tube (mm) D1	Largest outer dia. tube (mm) D2	Dimension (mm) L	Dimension (mm) L2	Dimension (mm) L3	Dimension (mm) L4	REF
1	51	54	650	290	500	280	118TA1504
	53	66	425	20	405	255	139TA4199
	55	55	205	95	130		105TA7359
	55	60	520	110	420		139TA4200
	56	59	610	145	480		139TA4201
	58	63	1640	60		125	139TA4202
	58	64	1400	60	1360	145	139TA4203
	60	60	215	140	110		139TA4204
	60	60	245	115	145		139TA4205
	60	64	1515	45	1475	100	139TA4206
	60	67	340	40	315	230	139TA4207
	61	61	105	45	55		139TA4208



EXHAUST TUBES

For all our latest catalogue updates and company info: www.tvh.com



EXHAUST TUBES

used for: **STILL**

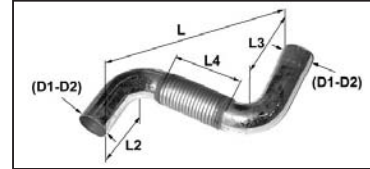

Number of bends AT-BO	Smallest outer dia. tube (mm) D1	Largest outer dia. tube (mm) D2	Dimension (mm) L	Dimension (mm) L2	Dimension (mm) L3	Dimension (mm) L4	REF
1	69	76	1265	80	1240		139TA4209
	70	70	190	75	115		139TA4210
2	37	37	557	165	190		139TA4211
	40	42	225	90	110		134TA6272
	40	60	1355	110	430		139TA4212
	41	58	1230	40	250		139TA4213
	42	42	1510	70	260		139TA4214
	42	45	355	35	240	165	124TA1045
	42	45	1440	80	110	840	134TA5558
	42	54	315	65	90	145	139TA4215
	42	55	310	75	80	145	139TA4216
	48	50	320	35	150	85	134TA6058

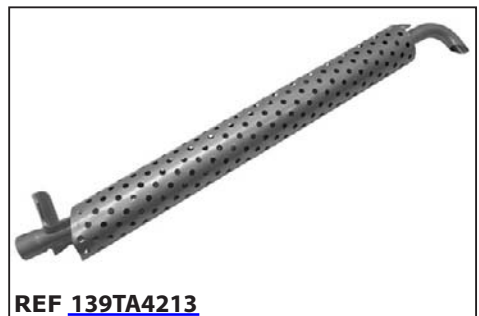

EXHAUST TUBES

For all our latest catalogue updates and company info: www.tvh.com

EXHAUST TUBES

used for: **STILL**

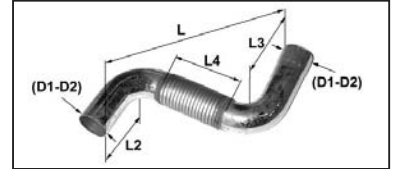

Number of bends AT-BO	Smallest outer dia. tube (mm) D1	Largest outer dia. tube (mm) D2	Dimension (mm) L	Dimension (mm) L2	Dimension (mm) L3	Dimension (mm) L4	REF
2	48	51	265	62	130	80	134TA6059
	50	50	230	55	120		139TA4217
	50	51	500	100	410	130	108TA4438
	50	55	370	95	180	110	139TA4218
	51	51	428	75	240		139TA4219
	51	54	500	90	115	150	139TA4220
	53	55	480	50	200	255	139TA4221
	54	60	1340	90	440		139TA4222
	55	60	360	75	215		139TA4223
	55	60	430	50	110	150	139TA4224
	59	61	227	78	125		108TA8883
	60	60	450	170	180		139TA4225

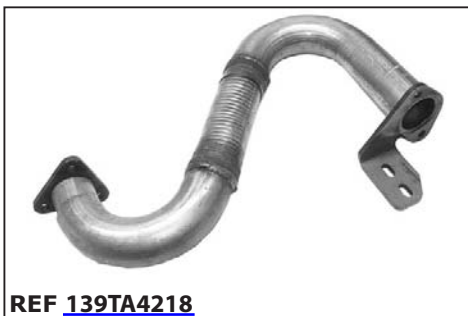

EXHAUST TUBES

For all our latest catalogue updates and company info: www.tvh.com



EXHAUST TUBES

used for: **STILL**

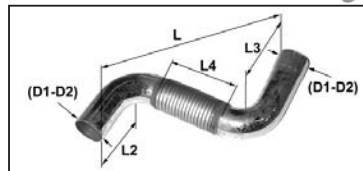

Number of bends AT-BO	Smallest outer dia. tube (mm) D1	Largest outer dia. tube (mm) D2	Dimension (mm) L	Dimension (mm) L2	Dimension (mm) L3	Dimension (mm) L4	REF
2	60	60	460	160	210		139TA4226
3	42	42	695	52	120		139TA4227
	42	46	1617	70	85		139TA4228
	42	47	1600	90	110		139TA4229
	49	55	435	70	70	150	139TA4230
	50	57	580	45	80		139TA4231
	50	59	440	45	230	70	139TA4232
	51	59	450	45	230	75	139TA4233
	54	60	1415	65	230		139TA4234
	55	55	445	115	140		139TA4235
	55	55	562	30	115		139TA4236
	55	55	695	94	340		139TA4237



EXHAUST TUBES

For all our latest catalogue updates and company info: www.tvh.com

EXHAUST TUBES

used for: **STILL**

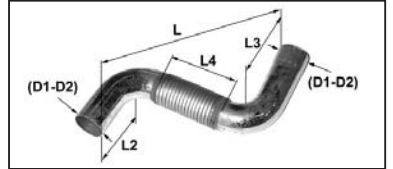

Number of bends AT-BO	Smallest outer dia. tube (mm) D1	Largest outer dia. tube (mm) D2	Dimension (mm) L	Dimension (mm) L2	Dimension (mm) L3	Dimension (mm) L4	REF
3	60	60	500	70	75		139TA4238
4	39	42	705	65	145		139TA4239
	45	45	570	70	80	260	123TA6717
	49	59	365	65	225	80	139TA4240
	49	60	670	50	75		139TA4241
	55	55	720	160	260		139TA4242
	55	55	780	220	260		139TA4243
5	69	71	1265	80	100		139TA4244



EXHAUST TUBES

For all our latest catalogue updates and company info: www.tvh.com



EXHAUST TUBES

used for: **SVE TRUCK**

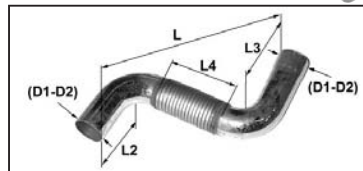

Number of bends	Smallest outer dia. tube (mm)	Largest outer dia. tube (mm)	Dimension (mm)	Dimension (mm)	Dimension (mm)	Dimension (mm)	REF
AT-BO	D1	D2	L	L2	L3	L4	
1	76	79	1160	40	1125		134TA5591
	96	101	1120	45	1065		139TA4245
	100	105	345	120	280		134TA6293
	102	106	930	50	880		139TA4246
2	62	89	295	40	80		134TA6295
	91	101	600	35	320		134TA6215



Look up these parts via

EXHAUST TUBES

For all our latest catalogue updates and company info: www.tvh.com

EXHAUST TUBES

used for: **TAILIFT**

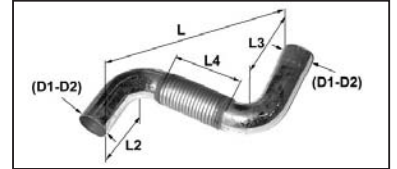

Number of bends AT-BO	Smallest outer dia. tube (mm) D1	Largest outer dia. tube (mm) D2	Dimension (mm) L	Dimension (mm) L2	Dimension (mm) L3	Dimension (mm) L4	REF
0	45	49	190				139TA4247
1	42	45	640	405	505	135	139TA4248
3	42	42	395	75	150	135	134TA6302
	42	47	587	80	420	150	139TA4249
4	40	42	750	45	120	140	134TA5912
	41	42	410	35	75	135	134TA5916
	42	42	455	45	355	270	139TA4250
	42	42	720	40	165	140	134TA5812
	42	57	730	125	130	170	118TA1568
	48	54	613	30	100	145	139TA4251
5	41	42	590	70	120	135	134TA5904
	42	42	550	50	125	130	134TA5908



EXHAUST TUBES

For all our latest catalogue updates and company info: www.tvh.com

EXHAUST TUBES

used for: **TCM**

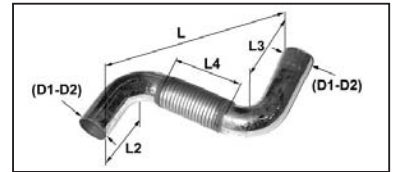

Number of bends AT-BO	Smallest outer dia. tube (mm) D1	Largest outer dia. tube (mm) D2	Dimension (mm) L	Dimension (mm) L2	Dimension (mm) L3	Dimension (mm) L4	REF
0	34	39	245				134TA6126
	35	38	179				108TA4458
	35	38	280				105TA7439
	38	49	305			210	134TA5806
	40	45	250				134TA6022
	43	46	340				124TA7249
1	35	38	165	80	95		105TA7352
	35	38	215	80	140		105TA7363
	35	39	150	50	100		139TA4253
	38	40	295	150	190		134TA5853
	38	41	290	170	195		105TA7440
	38	41	290	175	183		134TA5711

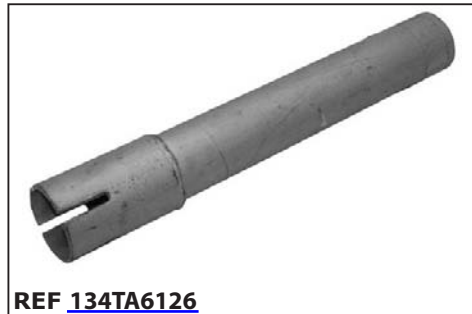

EXHAUST TUBES

For all our latest catalogue updates and company info: www.tvh.com



EXHAUST TUBES

used for: **TCM**

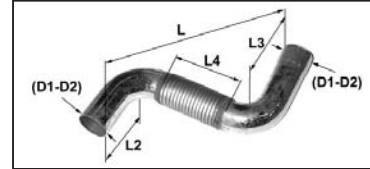

Number of bends	Smallest outer dia. tube (mm)	Largest outer dia. tube (mm)	Dimension (mm)	Dimension (mm)	Dimension (mm)	Dimension (mm)	REF
AT-BO	D1	D2	L	L2	L3	L4	
1	38	41	370	190	270		105TA6970
	38	42	310	110	285		139TA4254
	51	54	135	60	85		139TA4255
	54	57	245	83	185		105TA7417
	54	57	380	160	310		124TA1066
	54	57	942	450	500		134TA5948
	57	57	420	170	325		118TA1525
	57	61	205	90	130		105TA6913
	57	61	510	100	500		134TA6328
	57	61	1260	50	1210		124TA1067
	57	62	335	125	310		105TA7284
2	32	45	124	40	45		110TA9624

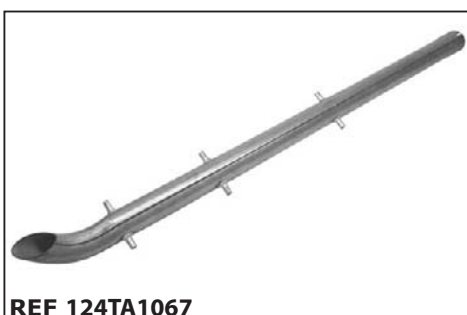

EXHAUST TUBES

For all our latest catalogue updates and company info: www.tvh.com

EXHAUST TUBES

used for: **TCM**

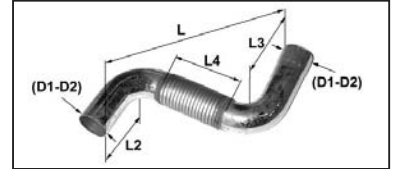

Number of bends AT-BO	Smallest outer dia. tube (mm) D1	Largest outer dia. tube (mm) D2	Dimension (mm) L	Dimension (mm) L2	Dimension (mm) L3	Dimension (mm) L4	REF
2	37	42	545	110	320		105TA6961
	38	38	270	45	135		134TA5807
	38	42	265	85	130		105TA6940
	38	42	405	130	245		124TA1064
	38	47	540	105	315		134TA5687
	38	47	545	105	335		139TA4256
	40	43	200	40	95		106TA5018
	40	45	535	85	130		134TA6034
	41	45	330	125	155		139TA4257
	42	42	540	100	290		108TA4503
	43	43	220	80	140		105TA7350
	43	43	275	75	105		139TA4258

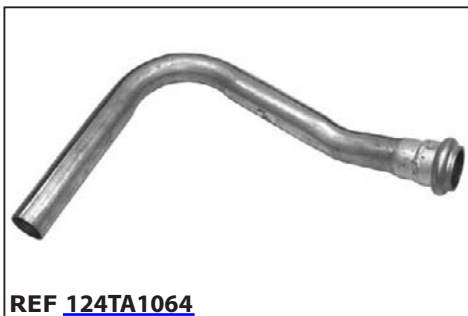
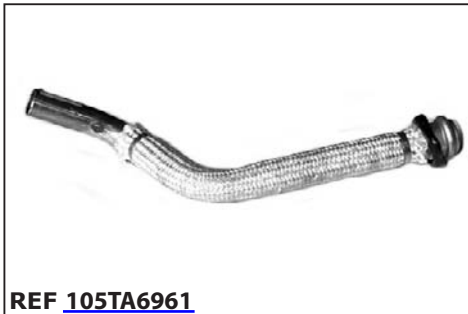

EXHAUST TUBES

For all our latest catalogue updates and company info: www.tvh.com



EXHAUST TUBES

used for: **TCM**

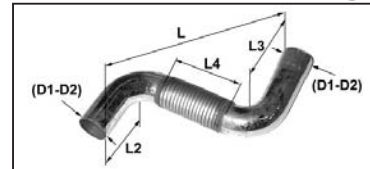

Number of bends AT-BO	Smallest outer dia. tube (mm) D1	Largest outer dia. tube (mm) D2	Dimension (mm) L	Dimension (mm) L2	Dimension (mm) L3	Dimension (mm) L4	REF
2	43	44	260	70	300	195	134TA6313
	45	45	265	75	75		139TA4259
	47	57	535	120	145		118TA1667
	49	49	470	125	235	130	134TA6066
	53	70	490	170	190		106TA5032
	54	56	765	170	255		134TA5809
	54	57	815	155	360		106TA5028
	54	70	475	155	165		111TA3677
	54	82	595	110	275		124TA7625
	57	57	290	80	120		123TA6720
	57	57	560	65	370		134TA6269
	57	61	430	130	240		105TA7295



REF [134TA6313](#)

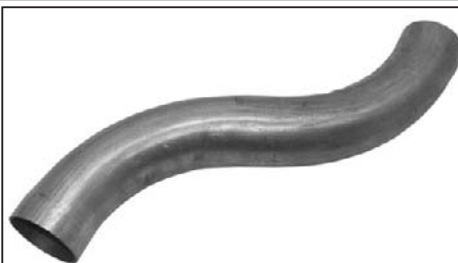

REF [139TA4259](#)

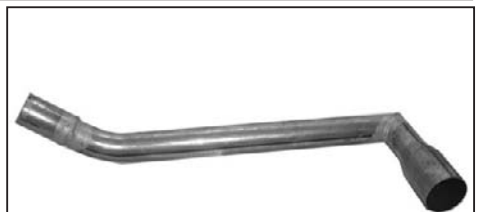

REF [118TA1667](#)



REF [134TA6066](#)



REF [106TA5032](#)



REF [134TA5809](#)



REF [106TA5028](#)



REF [111TA3677](#)



REF [124TA7625](#)



REF [123TA6720](#)



REF [134TA6269](#)

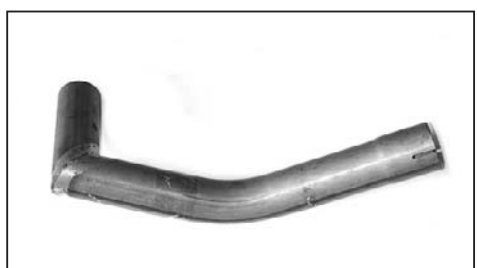

REF [105TA7295](#)

EXHAUST TUBES

For all our latest catalogue updates and company info: www.tvh.com

EXHAUST TUBES

used for: **TCM**

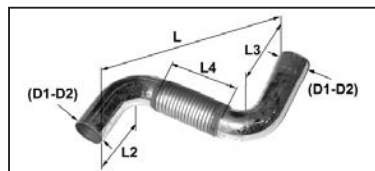

Number of bends	Smallest outer dia. tube (mm) D1	Largest outer dia. tube (mm) D2	Dimension (mm) L	Dimension (mm) L2	Dimension (mm) L3	Dimension (mm) L4	REF
2	57	61	480	154	320		118TA1526
	57	70	475	190	230		139TA4260
	58	60	220	50	105		134TA6320
	61	61	320	80	105	180	105TA6950
	61	61	490	50	150		105TA6906
	61	64	790	170	610		124TA4495
3	38	38	590	140	300		134TA5929
	38	42	465	125	125		124TA5145
	38	42	545	60	240		105TA7093
	42	42	555	140	320		105TA6959
	42	42	692	85	115		106TA6245
	42	43	655	50	130		105TA7422



EXHAUST TUBES

For all our latest catalogue updates and company info: www.tvh.com



EXHAUST TUBES

used for: **TCM**

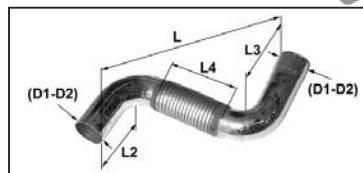

Number of bends AT-BO	Smallest outer dia. tube (mm) D1	Largest outer dia. tube (mm) D2	Dimension (mm) L	Dimension (mm) L2	Dimension (mm) L3	Dimension (mm) L4	REF
3	42	46	650	65	150		108TA4523
	42	47	530	110	120		106TA5029
	43	43	285	70	80		134TA5893
	43	43	325	45	80		105TA7346
	43	43	336	85	145		110TA8609
	43	46	560	95	185		105TA7109
	43	47	580	100	125		134TA6168
	44	44	410	30	45	255	134TA6112
	50	53	760	90	200	195	139TA4261
	51	51	640	135	155	125	134TA5976
	53	53	910	70	125	150	123TA6721
	54	70	880	120	195	150	134TA6149



EXHAUST TUBES

For all our latest catalogue updates and company info: www.tvh.com

EXHAUST TUBES

used for: **TCM**

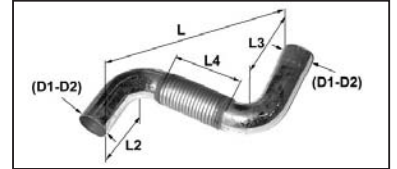

Number of bends AT-BO	Smallest outer dia. tube (mm) D1	Largest outer dia. tube (mm) D2	Dimension (mm) L	Dimension (mm) L2	Dimension (mm) L3	Dimension (mm) L4	REF
3	60	60	1040	90	265		134TA5708
	61	61	640	190	200	115	134TA6290
	76	76	1520	50	185		134TA6268
4	32	32	440	50	195		123TA6722
	37	38	587	40	108		110TA8601
	37	38	673	90	110		108TA4374
	38	38	743	80	155	160	139TA4262
	38	43	500	70	235		105TA7446
	41	46	555	175	220		139TA4263
	42	42	325	85	220		105TA6910
	42	42	490	85	125		110TA8602
	42	42	670	55	130		105TA7254



EXHAUST TUBES

For all our latest catalogue updates and company info: www.tvh.com



EXHAUST TUBES

used for: **TCM**

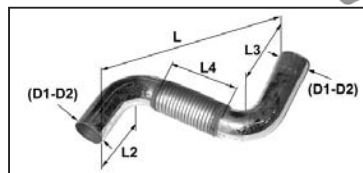

Number of bends	Smallest outer dia. tube (mm)	Largest outer dia. tube (mm)	Dimension (mm)	Dimension (mm)	Dimension (mm)	Dimension (mm)	REF
AT-BO	D1	D2	L	L2	L3	L4	
4	42	43	330	80	200		108TA4468
	42	43	355	105	205		118TA1617
	42	43	555	145	185		105TA7436
	42	43	570	140	200		105TA7253
	42	45	630	85	100		134TA6336
	43	49	800	88	105		123TA6723
	60	80	1455	115	360		134TA5820
5	38	38	545	85	105		105TA7040
	38	38	570	65	165		105TA6904
	38	38	770	55	142	185	134TA6363
	38	38	860	70	115		106TA5020
	38	42	610	70	90		105TA7330

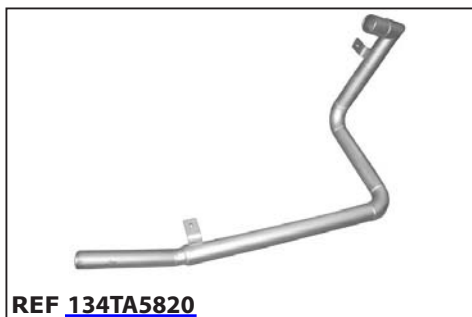

EXHAUST TUBES

For all our latest catalogue updates and company info: www.tvh.com

EXHAUST TUBES

used for: **TCM**

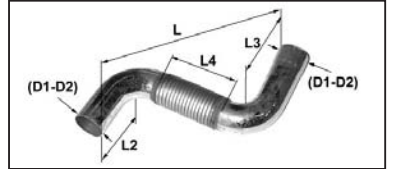

Number of bends AT-BO	Smallest outer dia. tube (mm) D1	Largest outer dia. tube (mm) D2	Dimension (mm) L	Dimension (mm) L2	Dimension (mm) L3	Dimension (mm) L4	REF
5	42	42	270	80	115		108TA4522
	42	42	645	50	80		105TA7263
	42	44	730	50	115		106TA5027
	43	43	710	55	150		105TA7183
	70	75	515	38	38		105TA7326
6	42	42	675	60	140		105TA7154
7	38	42	690	80	140		105TA7155

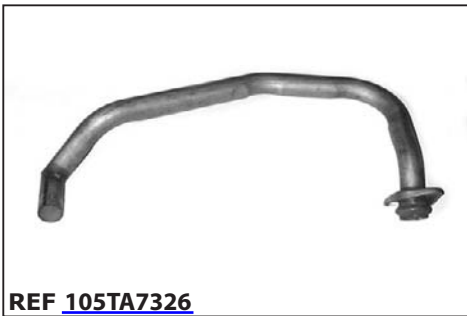

EXHAUST TUBES

For all our latest catalogue updates and company info: www.tvh.com



EXHAUST TUBES

used for: **TENNANT**

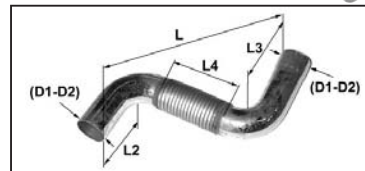

Number of bends AT-BO	Smallest outer dia. tube (mm) D1	Largest outer dia. tube (mm) D2	Dimension (mm) L	Dimension (mm) L2	Dimension (mm) L3	Dimension (mm) L4	REF
0	51	54	43				139TA4264
1	38	42	320	147	254		134TA5691
	40	42	857	48	80		139TA4265
	41	45	210	115	140		139TA4266
2	29	31	520	35	315		139TA4267
	41	45	465	80	85	160	134TA5740
	42	45	370	80	95		105TA6969
3	41	46	503	75	95		134TA5627
4	41	46	710	85	175		139TA4268



EXHAUST TUBES

For all our latest catalogue updates and company info: www.tvh.com



EXHAUST TUBES

used for: **TOYOTA**

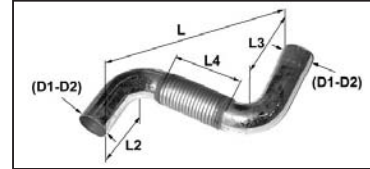

Number of bends	Smallest outer dia. tube (mm) D1	Largest outer dia. tube (mm) D2	Dimension (mm) L	Dimension (mm) L2	Dimension (mm) L3	Dimension (mm) L4	REF
0	46	47	495			365	110TA8597
	47	47	60				108TA8271
1	36	42	70	46	46		134TA6128
	38	38	100	38	90		123TA6724
	38	42	327	110	302		108TA8279
	38	43	405	70	400	330	105TA7258
	39	43	245	70	245	180	134TA5936
	42	65	614	55	594		108TA4531
	43	43	265	105	202		108TA8272
	43	43	270	130	235	170	105TA7420
	43	43	345	200	235		105TA7187
	47	47	317	117	210		123TA6725

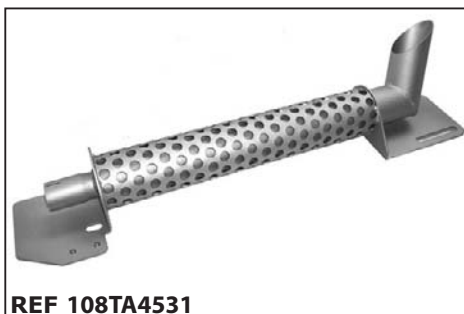
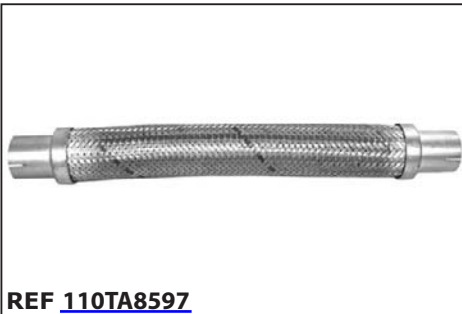

EXHAUST TUBES

For all our latest catalogue updates and company info: www.tvh.com

used for: **TOYOTA**

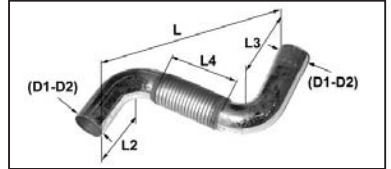

EXHAUST TUBES

Number of bends AT-BO	Smallest outer dia. tube (mm) D1	Largest outer dia. tube (mm) D2	Dimension (mm) L	Dimension (mm) L2	Dimension (mm) L3	Dimension (mm) L4	REF
1	48	57	265	115	160		124TA1079
	49	49	260	90	220		134TA5778
	49	57	280	100	205		139TA4271
	54	54	420	137	290	175	118TA1623
	57	65	220	80	190		134TA6121
	60	60	210	105	105		123TA6726
	65	65	160	80	125		118TA1670
	65	65	245	15	195		123TA6727
	77	77	180	36	130		124TA2090
	2	38	38	335	100	195	
38		41	265	85	155		105TA7398
38		41	495	105	230		134TA6150



EXHAUST TUBES

For all our latest catalogue updates and company info: www.tvh.com



EXHAUST TUBES

used for: **TOYOTA**

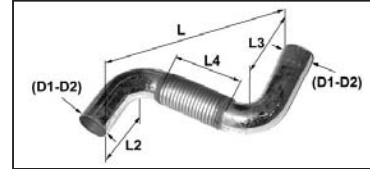

Number of bends	Smallest outer dia. tube (mm) D1	Largest outer dia. tube (mm) D2	Dimension (mm) L	Dimension (mm) L2	Dimension (mm) L3	Dimension (mm) L4	REF
2	38	43	215	50	55	120	105TA7306
	38	43	350	95	100		139TA4273
	39	42	380	65	255	155	134TA5827
	40	43	375	55	90		123TA6728
	42	42	252	80	130		108TA4552
	42	42	625	165	260	180	139TA4274
	42	43	422	110	270		108TA4441
	42	48	378	125	125		108TA4548
	42	49	320	80	125		134TA6199
	42	49	365	90	210		134TA6198
	42	66	910	50	120		108TA8273
	43	43	220	50	65		105TA7112

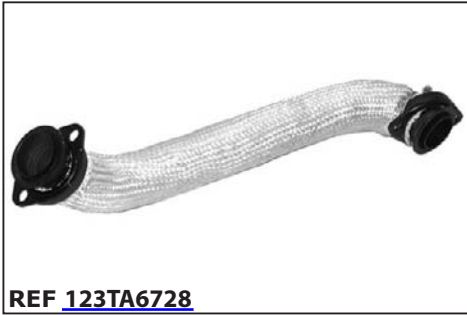

EXHAUST TUBES

For all our latest catalogue updates and company info: www.tvh.com

used for: **TOYOTA**

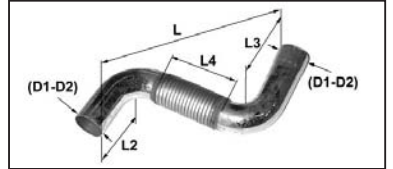

EXHAUST TUBES

Number of bends AT-BO	Smallest outer dia. tube (mm) D1	Largest outer dia. tube (mm) D2	Dimension (mm) L	Dimension (mm) L2	Dimension (mm) L3	Dimension (mm) L4	REF
2	43	43	297	40	90	160	124TA2088
	43	43	420	45	80		124TA2084
	43	44	460	53	120	195	108TA4549
	43	47	404	115	125		108TA4547
	45	45	370	10	110	150	134TA6092
	47	49	280	70	110		134TA6240
	47	52	236	65	95		108TA4465
	48	54	575	185	370	100	105TA7277
	48	55	385	185	190	105	105TA7378
	48	55	585	155	380	115	108TA4467
	48	57	453	165	245		124TA2081
	49	54	400	210	265		105TA7421

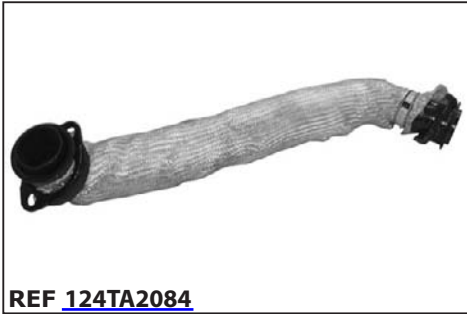

EXHAUST TUBES

For all our latest catalogue updates and company info: www.tvh.com



EXHAUST TUBES

used for: **TOYOTA**

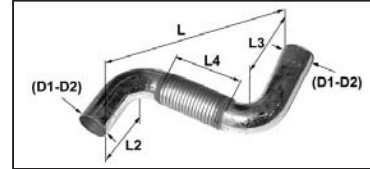

Number of bends	Smallest outer dia. tube (mm) D1	Largest outer dia. tube (mm) D2	Dimension (mm) L	Dimension (mm) L2	Dimension (mm) L3	Dimension (mm) L4	REF
2	51	51	325	165	240		105TA7399
	51	52	765	125	280		105TA7166
	51	54	602	190	210		106TA5024
	51	58	210	32	180		124TA2089
	51	58	306	32	282		124TA2083
	54	54	300	65	330		134TA6124
	55	60	495	100	130		118TA1685
	55	65	545	130	200		134TA5829
	58	58	808	60	636		124TA2086
	60	60	730	140	180		123TA6729
	62	66	895	100	155		105TA7334
	63	65	585	110	515	350	134TA6365



REF [105TA7399](#)



REF [105TA7166](#)



REF [106TA5024](#)



REF [124TA2089](#)



REF [124TA2083](#)



REF [134TA6124](#)



REF [118TA1685](#)



REF [134TA5829](#)



REF [124TA2086](#)



REF [123TA6729](#)



REF [105TA7334](#)



REF [134TA6365](#)

EXHAUST TUBES

For all our latest catalogue updates and company info: www.tvh.com

used for: **TOYOTA**

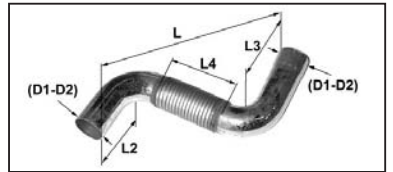

EXHAUST TUBES

Number of bends AT-BO	Smallest outer dia. tube (mm) D1	Largest outer dia. tube (mm) D2	Dimension (mm) L	Dimension (mm) L2	Dimension (mm) L3	Dimension (mm) L4	REF
2	63	65	660	80	475	330	105TA7275
	65	65	680	150	400		105TA7274
	65	88	570	55	170		134TA6315
	66	77	495	125	255		124TA2091
3	38	39	427	30	75		118TA1506
	38	40	540	85	290		105TA7296
	38	43	375	60	285	215	105TA7372
	38	43	455	65	135		105TA7304
	38	43	470	60	135		105TA7380
	38	43	535	85	190		123TA6730
	38	43	680	60	145	155	105TA7095
	38	44	427	46	110		124TA2085

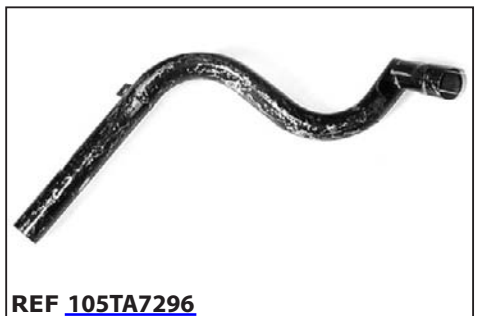

EXHAUST TUBES

For all our latest catalogue updates and company info: www.tvh.com



EXHAUST TUBES

used for: **TOYOTA**

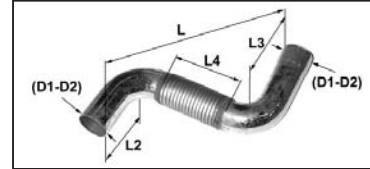

Number of bends AT-BO	Smallest outer dia. tube (mm) D1	Largest outer dia. tube (mm) D2	Dimension (mm) L	Dimension (mm) L2	Dimension (mm) L3	Dimension (mm) L4	REF
3	38	49	380	105	120		123TA6731
	38	49	405	75	95		139TA4275
	38	75	1035	20	100		139TA4276
	39	43	620	115	270	170	124TA5150
	41	42	410	185	240		134TA6068
	41	51	1440	30	465		134TA6046
	42	42	430	120	140		139TA4277
	42	42	750	75	120	150	139TA4278
	42	43	395	40	125		110TA9718
	42	43	590	85	197		111TA3685
	42	43	635	75	200		105TA7001
	42	49	405	80	90		139TA4279



REF [123TA6731](#)



REF [139TA4275](#)



REF [139TA4276](#)



REF [124TA5150](#)



REF [134TA6068](#)



REF [134TA6046](#)



REF [139TA4277](#)



REF [139TA4278](#)



REF [110TA9718](#)



REF [111TA3685](#)



REF [105TA7001](#)



REF [139TA4279](#)

EXHAUST TUBES

For all our latest catalogue updates and company info: www.tvh.com

used for: **TOYOTA**

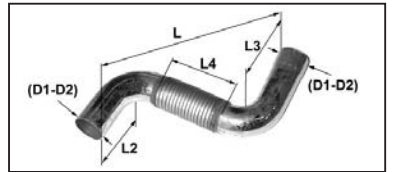

EXHAUST TUBES

Number of bends AT-BO	Smallest outer dia. tube (mm) D1	Largest outer dia. tube (mm) D2	Dimension (mm) L	Dimension (mm) L2	Dimension (mm) L3	Dimension (mm) L4	REF
3	42	65	1280	20	395		124TA7248
	43	43	295	60	85		106TA6316
	43	43	418	30	90		124TA1083
	43	43	640	95	205		105TA7148
	43	44	380	30	80		108TA4495
	43	48	385	120	120		123TA6732
	43	49	410	140	140		134TA5795
	43	65	980	55	100		105TA6689
	45	45	500	50	100	150	105TA7081
	47	47	1040	140	325		108TA8276
	47	51	725	100	180		105TA7169
	48	54	555	55	125	280	105TA7087

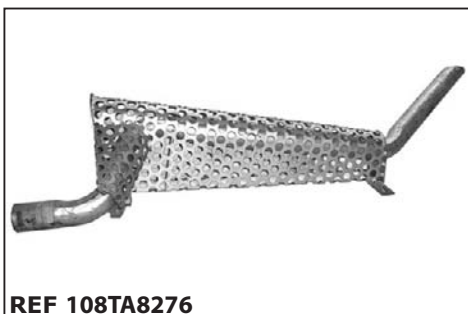

EXHAUST TUBES

For all our latest catalogue updates and company info: www.tvh.com



EXHAUST TUBES

used for: **TOYOTA**

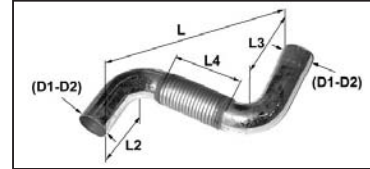

Number of bends	Smallest outer dia. tube (mm) D1	Largest outer dia. tube (mm) D2	Dimension (mm) L	Dimension (mm) L2	Dimension (mm) L3	Dimension (mm) L4	REF
3	51	54	665	140	140		108TA8277
	60	60	684	300	430		124TA2082
	60	61	820	150	180		105TA7425
	60	65	235	120	180		134TA5946
	64	76	1001	50	130		123TA6733
	65	66	675	93	215		134TA6203
4	37	42	1028	40	175		108TA8274
	37	43	525	60	100		105TA6973
	38	43	670	52	237		108TA4532
	38	49	413	100	100		108TA4493
	38	49	500	105	110		134TA6333
	38	75	1080	30	115		134TA6196



EXHAUST TUBES

For all our latest catalogue updates and company info: www.tvh.com

used for: **TOYOTA**

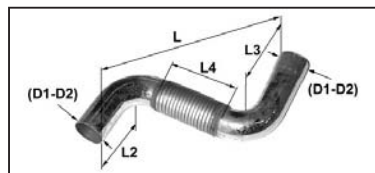

EXHAUST TUBES

Number of bends AT-BO	Smallest outer dia. tube (mm) D1	Largest outer dia. tube (mm) D2	Dimension (mm) L	Dimension (mm) L2	Dimension (mm) L3	Dimension (mm) L4	REF
4	38	75	1117	50	162		118TA1645
	39	76	1120	50	155		134TA5792
	39	77	1062	50	160		118TA1653
	40	43	490	40	90		118TA1688
	40	43	495	30	105		105TA6953
	40	43	700	90	145	130	139TA4280
	41	42	500	45	110		105TA7191
	41	42	520	65	90		118TA1549
	41	42	1076	170	360		108TA4389
	41	43	770	65	140	140	105TA6932
	42	42	510	35	220		106TA6312
	42	42	700	55	90	145	124TA2095



EXHAUST TUBES

For all our latest catalogue updates and company info: www.tvh.com



EXHAUST TUBES

used for: **TOYOTA**

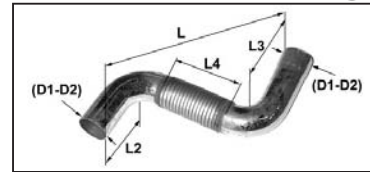

Number of bends AT-BO	Smallest outer dia. tube (mm) D1	Largest outer dia. tube (mm) D2	Dimension (mm) L	Dimension (mm) L2	Dimension (mm) L3	Dimension (mm) L4	REF
4	42	43	500	85	85		105TA7115
	42	43	515	60	115		105TA7445
	42	43	515	70	80	135	105TA7111
	42	43	558	60	90		105TA6979
	42	44	504	80	90		108TA4551
	43	43	405	40	105		105TA7182
	43	43	490	225	250		108TA4511
	43	43	500	90	125		105TA7009
	43	43	505	75	110		105TA7117
	43	43	515	60	65	155	139TA4281
	43	43	730	38	90	137	134TA6084
	43	43	738	45	90	170	124TA2087



EXHAUST TUBES

For all our latest catalogue updates and company info: www.tvh.com

used for: **TOYOTA**

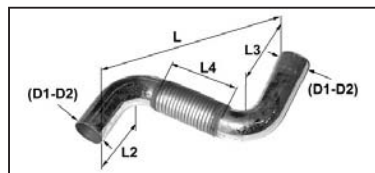

EXHAUST TUBES

Number of bends AT-BO	Smallest outer dia. tube (mm) D1	Largest outer dia. tube (mm) D2	Dimension (mm) L	Dimension (mm) L2	Dimension (mm) L3	Dimension (mm) L4	REF
4	43	43	785	75	130	140	105TA7125
	43	49	411	90	100		108TA4406
	43	49	495	100	110		134TA6197
	43	76	950	70	235		124TA2099
	48	54	716	95	115	150	108TA4390
	48	66	625	120	155		105TA7067
	50	52	650	35	35	200	139TA4282
	53	64	656	95	145		108TA4550
	54	60	305	30	70		105TA7289
	60	60	815	80	340		134TA6019
	60	62	700	55	275		105TA6978
	65	65	790	220	365		111TA3680



REF [105TA7125](#)



REF [108TA4406](#)



REF [134TA6197](#)



REF [124TA2099](#)



REF [108TA4390](#)



REF [105TA7067](#)



REF [139TA4282](#)



REF [108TA4550](#)



REF [105TA7289](#)



REF [134TA6019](#)



REF [105TA6978](#)



REF [111TA3680](#)

EXHAUST TUBES

For all our latest catalogue updates and company info: www.tvh.com



EXHAUST TUBES

used for: **TOYOTA**

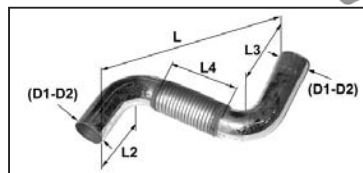

Number of bends AT-BO	Smallest outer dia. tube (mm) D1	Largest outer dia. tube (mm) D2	Dimension (mm) L	Dimension (mm) L2	Dimension (mm) L3	Dimension (mm) L4	REF
5	38	42	750	67	125	150	134TA5824
	38	42	1120	127	220		118TA1625
	39	42	680	40	90	180	134TA6029
	41	42	750	70	85	165	134TA5721
	41	43	880	70	120	180	124TA5149
	41	43	915	75	115	150	134TA5791
	42	42	690	65	65	155	134TA5980
	42	42	730	95	120	150	105TA6993
	42	42	745	80	115	135	134TA5828
	42	42	884	70	120	150	108TA4400
	42	43	660	45	145	155	134TA6148
	42	43	700	80	120	147	108TA4546



EXHAUST TUBES

For all our latest catalogue updates and company info: www.tvh.com

used for: **TOYOTA**

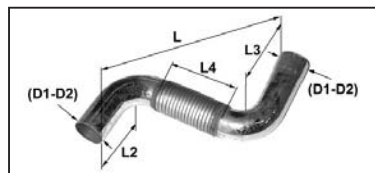

EXHAUST TUBES

Number of bends AT-BO	Smallest outer dia. tube (mm) D1	Largest outer dia. tube (mm) D2	Dimension (mm) L	Dimension (mm) L2	Dimension (mm) L3	Dimension (mm) L4	REF
5	43	43	100	60	130	175	134TA5860
	43	43	200	70	110	185	108TA4521
	43	43	490	40	50		134TA6324
	43	43	500	35	130		105TA7180
	43	43	695	45	80	145	124TA2075
	43	43	695	45	90	145	134TA6287
	43	43	730	70	80	135	105TA7432
	43	43	745	90	130	140	134TA5498
	43	43	750	80	80	200	134TA5513
	43	43	780	65	65	140	105TA6935
	43	43	850	75	85	190	108TA4517
	43	43	850	90	125	160	123TA6735



EXHAUST TUBES

For all our latest catalogue updates and company info: www.tvh.com



EXHAUST TUBES

used for: **TOYOTA**

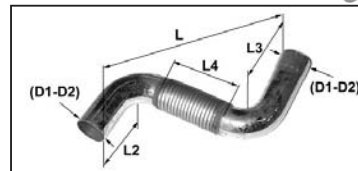

Number of bends	Smallest outer dia. tube (mm)	Largest outer dia. tube (mm)	Dimension (mm)	Dimension (mm)	Dimension (mm)	Dimension (mm)	REF
AT-BO	D1	D2	L	L2	L3	L4	
5	43	43	950	90	90	150	123TA6734
	43	43	970	120	130	155	134TA6142
	43	43	1045	90	120		139TA4283
	43	59	745	90	95	190	134TA5725
	43	59	973	90	140	200	118TA1581
	50	50	555	40	50	135	139TA4284
	51	54	645	155	165		105TA7272
	51	54	840	130	150		108TA8275
	58	58	906	65	135	150	108TA4387
6	38	42	700	60	80	150	134TA6368
	38	42	715	70	80	170	118TA1503
	38	42	815	60	70	180	139TA4285



REF [123TA6734](#)



REF [134TA6142](#)

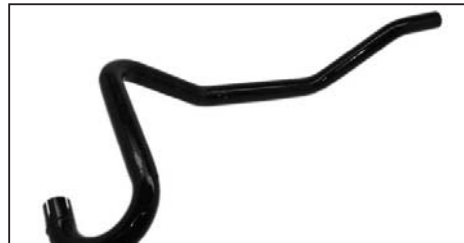

REF [139TA4283](#)



REF [134TA5725](#)



REF [118TA1581](#)



REF [139TA4284](#)



REF [105TA7272](#)



REF [108TA8275](#)

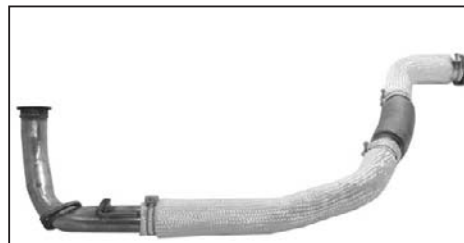

REF [108TA4387](#)



REF [134TA6368](#)



REF [118TA1503](#)



REF [139TA4285](#)

EXHAUST TUBES

For all our latest catalogue updates and company info: www.tvh.com

used for: **TOYOTA**

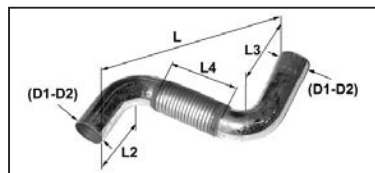

EXHAUST TUBES

Number of bends AT-BO	Smallest outer dia. tube (mm) D1	Largest outer dia. tube (mm) D2	Dimension (mm) L	Dimension (mm) L2	Dimension (mm) L3	Dimension (mm) L4	REF
6	38	42	865	70	110	170	139TA4286
	38	42	890	60	65	170	139TA4287
	38	42	1145	100	230		139TA4288
	38	43	880	60	80	155	139TA4289
	39	42	700	60	90	155	139TA4290
	40	42	690	45	85	140	105TA7266
	40	42	690	60	80	165	118TA1687
	40	42	695	60	90	140	105TA6893
	41	42	815	60	95	145	139TA4291
	42	42	630	60	70	155	108TA8278
	42	42	750	70	70	150	108TA4461
	42	42	795	75	80	180	139TA4292



REF [139TA4286](#)



REF [139TA4287](#)



REF [139TA4288](#)



REF [139TA4289](#)



REF [139TA4290](#)

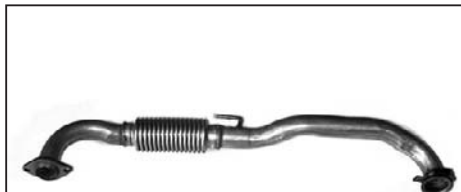

REF [105TA7266](#)

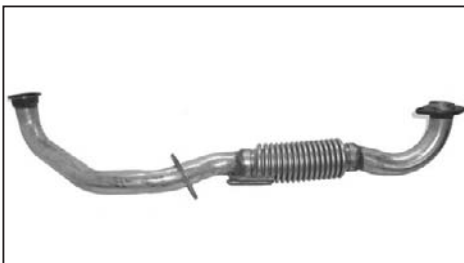

REF [118TA1687](#)

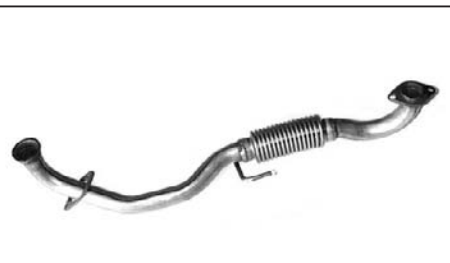

REF [105TA6893](#)



REF [139TA4291](#)

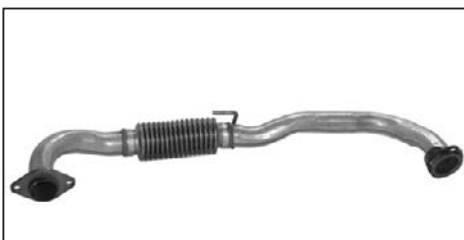

REF [108TA8278](#)



REF [108TA4461](#)



REF [139TA4292](#)

EXHAUST TUBES

For all our latest catalogue updates and company info: www.tvh.com



EXHAUST TUBES

used for: **TOYOTA**

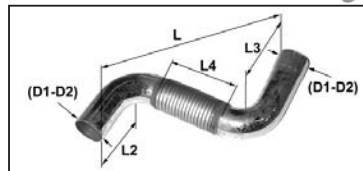

Number of bends AT-BO	Smallest outer dia. tube (mm) D1	Largest outer dia. tube (mm) D2	Dimension (mm) L	Dimension (mm) L2	Dimension (mm) L3	Dimension (mm) L4	REF
6	42	42	800	80	85	180	139TA4293
	42	43	635	75	130		105TA7341
	43	43	515	25	110		124TA1078
	43	43	600	35	35		134TA6305
	43	43	645	105	170		105TA6966
	43	43	680	40	80	140	139TA4294
	43	43	710	50	60	155	134TA5992
	43	43	820	85	90	145	134TA5541
	43	43	882	75	85	162	134TA6194
	43	43	920	60	80	150	139TA4295
	44	44	940	60	70	170	134TA6226
	48	49	850	60	100		105TA7238



EXHAUST TUBES

For all our latest catalogue updates and company info: www.tvh.com

used for: **TOYOTA**

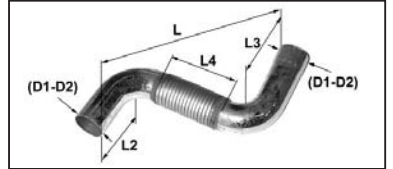

EXHAUST TUBES

Number of bends AT-BO	Smallest outer dia. tube (mm) D1	Largest outer dia. tube (mm) D2	Dimension (mm) L	Dimension (mm) L2	Dimension (mm) L3	Dimension (mm) L4	REF
6	65	65	720	80	100	255	105TA7231
7	38	42	965	80	120	160	139TA4296
	40	45	870	80	120	155	134TA6151
	42	43	940	75	120	140	134TA6082
	43	43	930	80	120	160	139TA4297
8	41	43	955	75	95	150	139TA4298
	42	43	945	55	90	160	134TA6263



Look up these parts via

myPS MyProductSearch

EXHAUST TUBES

For all our latest catalogue updates and company info: www.tvh.com



EXHAUST TUBES

used for: **YALE**

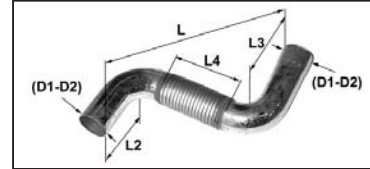

Number of bends	Smallest outer dia. tube (mm) D1	Largest outer dia. tube (mm) D2	Dimension (mm) L	Dimension (mm) L2	Dimension (mm) L3	Dimension (mm) L4	REF
0	53	53	252			200	123TA6737
	76	79	500				139TA4299
1	34	34	99	43	55		134TA6353
	35	35	227	95	140	85	134TA5762
	35	35	627	120	600	140	105TA7418
	35	38	315	80	275		134TA5825
	38	38	110	43	62		118TA1661
	38	38	130	50	145		139TA4300
	38	49	345	140	240	155	134TA6137
	39	39	210	80	230		123TA6738
	43	52	1070	60	1040		108TA4378
	43	56	1020	110	1000		123TA6740

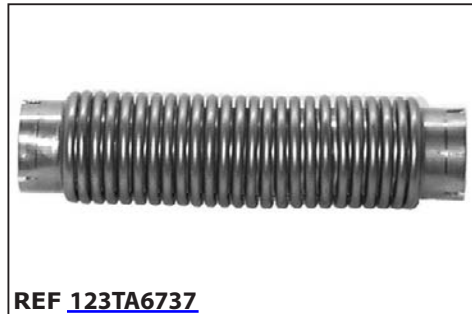

EXHAUST TUBES

For all our latest catalogue updates and company info: www.tvh.com

EXHAUST TUBES

used for: **YALE**

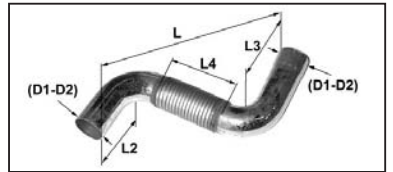

Number of bends AT-BO	Smallest outer dia. tube (mm) D1	Largest outer dia. tube (mm) D2	Dimension (mm) L	Dimension (mm) L2	Dimension (mm) L3	Dimension (mm) L4	REF
1	44	45	435	108	404		108TA4462
	45	48	260	70	280		139TA4301
	45	49	156	70	135		123TA6742
	46	49	295	145	165		134TA5779
	50	54	435	210	340		105TA7033
	51	51	185	80	150		139TA4302
	51	51	244	88	150		124TA2067
	51	51	285	95	195		139TA4303
	51	51	630	25	605		123TA6743
	51	55	275	105	220		134TA6181
	51	60	115	85	110		123TA6744
	51	72	230	140	155		134TA6179



EXHAUST TUBES

For all our latest catalogue updates and company info: www.tvh.com



EXHAUST TUBES

used for: **YALE**

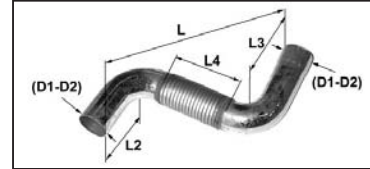

Number of bends AT-BO	Smallest outer dia. tube (mm) D1	Largest outer dia. tube (mm) D2	Dimension (mm) L	Dimension (mm) L2	Dimension (mm) L3	Dimension (mm) L4	REF
1	63	64	230	100	170		123TA6745
	64	64	213	95	155		123TA6746
	70	74	485	170	430		106TA7372
	76	76	498	127	375		118TA1658
	76	76	1270	120	1180		139TA4304
2	32	32	390	95	100		105TA7064
	33	38	265	45	110		134TA5727
	35	38	170	80	85		105TA6914
	35	38	215	65	100		123TA6747
	35	38	240	85	95		106TA7353
	35	38	310	75	175		106TA7378
	35	38	515	100	130		108TA4409



EXHAUST TUBES

For all our latest catalogue updates and company info: www.tvh.com

EXHAUST TUBES

used for: **YALE**

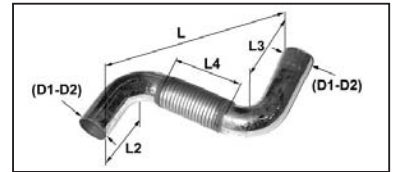

Number of bends AT-BO	Smallest outer dia. tube (mm) D1	Largest outer dia. tube (mm) D2	Dimension (mm) L	Dimension (mm) L2	Dimension (mm) L3	Dimension (mm) L4	REF
2	35	38	542	115	210		123TA6748
	35	38	570	115	145		106TA7361
	35	38	645	115	160		118TA1561
	35	39	650	105	170		123TA6749
	35	40	285	80	95		134TA5862
	38	38	240	68	85		118TA1660
	38	38	260	65	190		139TA4305
	38	38	345	60	175		105TA6923
	38	38	385	90	110		118TA1557
	38	38	385	95	115		139TA4306
	38	41	1150	30	230		139TA4307
	38	42	405	110	320		139TA4308



EXHAUST TUBES

For all our latest catalogue updates and company info: www.tvh.com



EXHAUST TUBES

used for: **YALE**

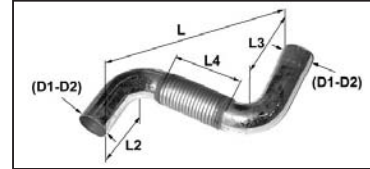

Number of bends AT-BO	Smallest outer dia. tube (mm) D1	Largest outer dia. tube (mm) D2	Dimension (mm) L	Dimension (mm) L2	Dimension (mm) L3	Dimension (mm) L4	REF
2	38	44	140	40	40		139TA4309
	38	44	1110	35	220		134TA6345
	38	44	1180	30	255		134TA5881
	38	48	380	70	110	160	123TA6750
	38	50	1160	20	240		139TA4310
	38	51	420	100	185		134TA6172
	42	51	375	225	290		139TA4311
	45	51	400	184	330		139TA4312
	47	49	780	80	610	140	123TA6752
	48	48	190	105	125		124TA7251
	49	51	375	105	120		105TA7443
	49	53	555	160	220	85	134TA6060



EXHAUST TUBES

For all our latest catalogue updates and company info: www.tvh.com

EXHAUST TUBES

used for: **YALE**

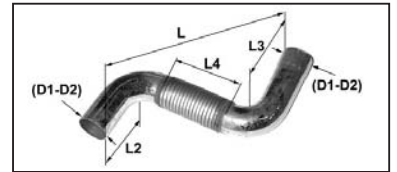

Number of bends AT-BO	Smallest outer dia. tube (mm) D1	Largest outer dia. tube (mm) D2	Dimension (mm) L	Dimension (mm) L2	Dimension (mm) L3	Dimension (mm) L4	REF
2	50	50	410	60	270		134TA5951
	50	54	267	50	155		134TA6045
	50	60	885	90	700	125	124TA5152
	51	51	340	100	210		105TA7353
	51	54	515	280	290		124TA2094
	51	55	1170	22	260		118TA1691
	60	60	410	75	195		134TA5877
	62	62	345	95	220	140	139TA4313
	69	74	1850	45	225		134TA5603
	69	74	1860	80	250		139TA4314
	70	73	575	210	225		123TA6753
	70	74	1855	60	170		123TA6754



REF [134TA5951](#)



REF [134TA6045](#)



REF [124TA5152](#)



REF [105TA7353](#)



REF [124TA2094](#)

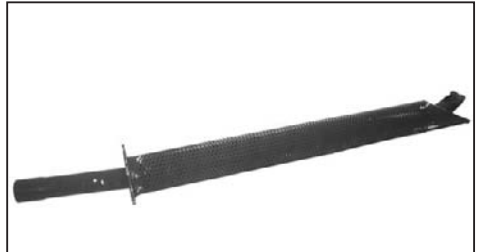

REF [118TA1691](#)



REF [134TA5877](#)



REF [139TA4313](#)



REF [134TA5603](#)



REF [139TA4314](#)

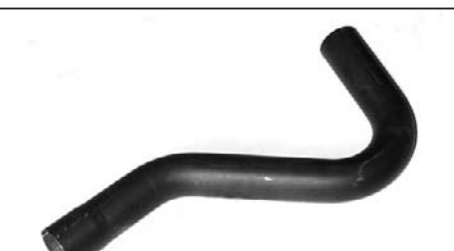

REF [123TA6753](#)



REF [123TA6754](#)

EXHAUST TUBES

For all our latest catalogue updates and company info: www.tvh.com



EXHAUST TUBES

used for: **YALE**

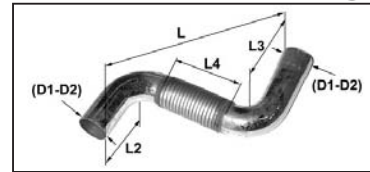

Number of bends AT-BO	Smallest outer dia. tube (mm) D1	Largest outer dia. tube (mm) D2	Dimension (mm) L	Dimension (mm) L2	Dimension (mm) L3	Dimension (mm) L4	REF
2	75	80	1230	100	350		134TA5886
	77	77	745	65	395		134TA5720
3	34	36	395	95	165	138	118TA1700
	35	35	412	80	110		108TA4471
	35	35	605	100	120		105TA7122
	35	38	195	65	65		139TA4315
	35	38	345	105	110		134TA6159
	35	38	428	85	135		139TA4316
	35	40	485	70	80		134TA5901
	36	38	485	70	80		105TA6908
	37	38	340	80	80		134TA6361
	38	38	415	75	115		110TA8605

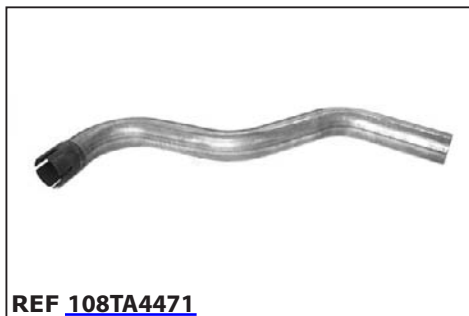

EXHAUST TUBES

For all our latest catalogue updates and company info: www.tvh.com

EXHAUST TUBES

used for: **YALE**

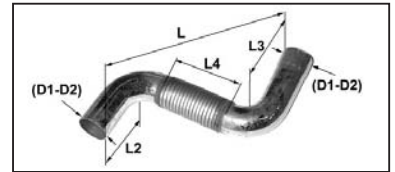

Number of bends AT-BO	Smallest outer dia. tube (mm) D1	Largest outer dia. tube (mm) D2	Dimension (mm) L	Dimension (mm) L2	Dimension (mm) L3	Dimension (mm) L4	REF
3	38	38	450	100	105		108TA4534
	38	38	480	55	105		105TA7132
	38	38	520	75	195		123TA6755
	38	38	650	70	120		108TA4459
	38	42	460	70	75		123TA6756
	38	48	440	180	220		139TA4317
	39	42	430	75	100		110TA8589
	40	60	375	75	80		134TA5940
	42	42	480	155	230	85	124TA2077
	43	43	390	45	165	80	105TA7193
	45	48	705	150	205	115	134TA5770
	45	55	417	90	180		108TA8891



EXHAUST TUBES

For all our latest catalogue updates and company info: www.tvh.com



EXHAUST TUBES

used for: **YALE**

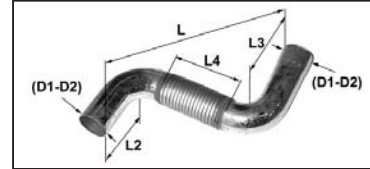

Number of bends	Smallest outer dia. tube (mm)	Largest outer dia. tube (mm)	Dimension (mm)	Dimension (mm)	Dimension (mm)	Dimension (mm)	REF
AT-BO	D1	D2	L	L2	L3	L4	
3	48	49	615	155	255		134TA5776
	48	53	675	60	205		124TA1056
	50	51	470	60	135		139TA4318
	50	51	955	40	50		123TA6757
	50	54	330	60	90		134TA6266
	50	54	420	50	185		105TA7444
	50	54	785	110	295		108TA4413
	50	55	625	75	160		134TA5968
	51	51	340	75	130		123TA6758
	51	51	375	75	165		124TA1073
4	35	35	540	85	110		134TA6245
	35	35	550	100	100		134TA5858



EXHAUST TUBES

For all our latest catalogue updates and company info: www.tvh.com

EXHAUST TUBES

used for: **YALE**

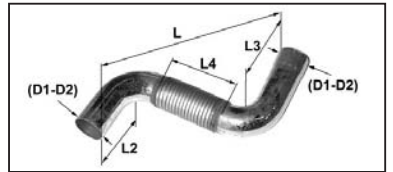

Number of bends AT-BO	Smallest outer dia. tube (mm) D1	Largest outer dia. tube (mm) D2	Dimension (mm) L	Dimension (mm) L2	Dimension (mm) L3	Dimension (mm) L4	REF
4	35	35	580	100	130		134TA6031
	35	35	605	100	135		124TA7631
	35	35	605	105	140		106TA7370
	35	35	650	100	140		139TA4319
	35	35	679	35	80		106TA6249
	35	35	705	100	130		105TA7259
	35	42	600	40	95	125	118TA1416
	38	38	460	30	125		105TA7126
	38	38	460	30	155		105TA7227
	38	38	505	30	160		106TA7360
	38	48	545	30	240	110	134TA6063
	45	45	775	95	215		134TA5774



EXHAUST TUBES

For all our latest catalogue updates and company info: www.tvh.com



EXHAUST TUBES

used for: **YALE**

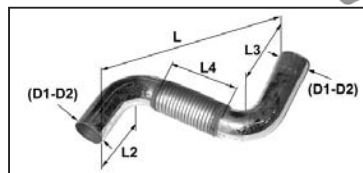

Number of bends	Smallest outer dia. tube (mm)	Largest outer dia. tube (mm)	Dimension (mm)	Dimension (mm)	Dimension (mm)	Dimension (mm)	REF
AT-BO	D1	D2	L	L2	L3	L4	
4	47	48	765	62	93	157	106TA7345
	50	51	475	65	100		134TA5729
	51	55	525	135	305		134TA6350
5	35	35	540	70	70		123TA6760
	35	35	570	95	105		105TA7340
	35	35	605	70	70		134TA5497
	35	35	652	70	80		108TA4411
	35	35	680	20	90		106TA7379
	35	35	695	70	160	90	139TA4320
	49	51	1085	70	260	145	134TA6062
	50	50	680	53	105		105TA7429
	50	55	553	55	120		123TA6761



REF [106TA7345](#)



REF [134TA5729](#)

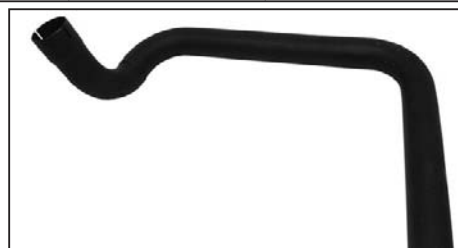

REF [134TA6350](#)

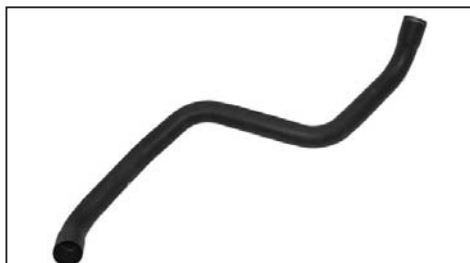

REF [123TA6760](#)



REF [105TA7340](#)



REF [134TA5497](#)



REF [108TA4411](#)



REF [106TA7379](#)



REF [139TA4320](#)



REF [134TA6062](#)

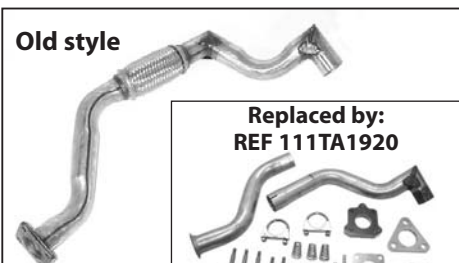

REF [105TA7429](#)



REF [123TA6761](#)

EXHAUST TUBES

For all our latest catalogue updates and company info: www.tvh.com

EXHAUST TUBES

used for: **YALE**

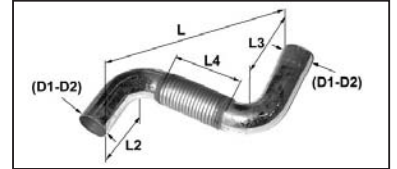

Number of bends AT-BO	Smallest outer dia. tube (mm) D1	Largest outer dia. tube (mm) D2	Dimension (mm) L	Dimension (mm) L2	Dimension (mm) L3	Dimension (mm) L4	REF
5	50	55	675	55	70		123TA6762
6	35	35	645	80	125		134TA5737
	50	54	847	57	90		108TA8281
7	35	35	780	25	70		134TA5508
	50	58	580	90	220		134TA6116



EXHAUST TUBES

For all our latest catalogue updates and company info: www.tvh.com



EXHAUST TUBES

used for: **YANG - YAM - PUMA**

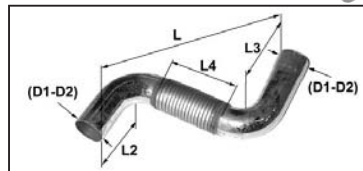

Number of bends AT-BO	Smallest outer dia. tube (mm) D1	Largest outer dia. tube (mm) D2	Dimension (mm) L	Dimension (mm) L2	Dimension (mm) L3	Dimension (mm) L4	REF
3	42	57	420	135	45	130	139TA4321
4	42	42	565	125	135	115	105TA6952
	42	57	630	40	80	140	134TA5768
5	42	42	585	90	150	140	134TA5805
	42	42	655	115	120	155	106TA7351
6	42	42	885	50	100	130	134TA5960



Look up these parts via