

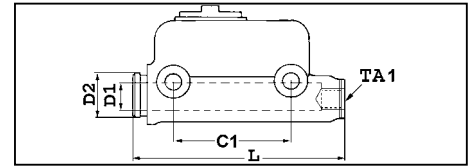

# MASTER & CLUTCH CYLINDERS

For all our latest catalogue updates and company info: [www.tvh.com](http://www.tvh.com)

used for: **CLARK-SAMSUNG**



MASTER & CLUTCH CYLINDERS

type of flange TY-FL	piston diameter (inch) D1	dimension (mm) L	dimension (mm) C1	dimension (mm) D2	quantity of outlets for oil AT-PR	thread outlet TA1	type of oil OLIE	reference
no flange	11/16	74	0	0	1		brake fluid	<a href="#">123TA1432</a>
	11/16	82,7	0	25	1		brake fluid	<a href="#">123TA1433</a>
	3/4	130	87,5	27	1		brake fluid	<a href="#">123TA1438</a>
	3/4	131	87	27	1		brake fluid	<a href="#">106TA3097</a>
	3/4	132	88,5	27	1		brake fluid	<a href="#">104TA4236</a>
	3/4	149	35	34	1	M12 X 1	mineral oil	<a href="#">123TA1434</a>
	3/4	149	35	34	1		brake fluid	<a href="#">123TA1436</a>
	3/4	150	35	34	1		brake fluid	<a href="#">123TA1435</a>
	3/4	150	35	34	1		brake fluid	<a href="#">123TA1437</a>
	3/4	152	35	34	1		brake fluid	<a href="#">106TA2987</a>
	3/4	175	78	29	1		brake fluid	<a href="#">104TA4286</a>
	7/8	58	49	30	1		brake fluid	<a href="#">123TA1439</a>

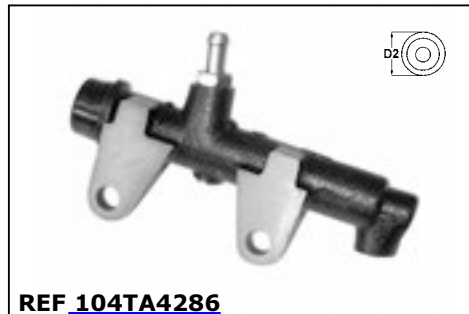
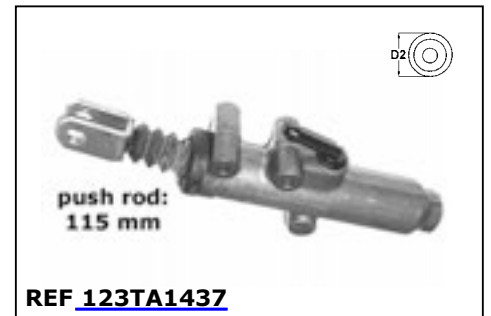

# MASTER & CLUTCH CYLINDERS

For all our latest catalogue updates and company info: [www.tvh.com](http://www.tvh.com)



used for: **CLARK-SAMSUNG**

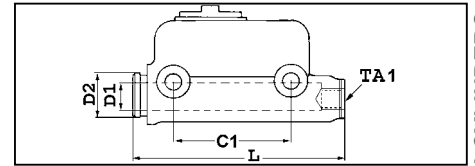

MASTER & CLUTCH CYLINDERS

type of flange TY-FL	piston diameter (inch) D1	dimension (mm) L	dimension (mm) C1	dimension (mm) D2	quantity of outlets for oil AT-PR	thread outlet TA1	type of oil OLIE	reference
no flange	7/8	155	0	51	2		brake fluid	<a href="#">123TA1449</a>
	15/16	152	35	35	1		brake fluid	<a href="#">123TA1440</a>
	15/16	152	35	35	1		brake fluid	<a href="#">123TA1442</a>
	15/16	153	35	35	1		brake fluid	<a href="#">124TA7888</a>
	15/16	153	35	35	1		mineral oil	<a href="#">123TA1443</a>
	1	120	25,5	35	1		brake fluid	<a href="#">123TA1444</a>
	1	129	79	38	1		brake fluid	<a href="#">106TA2853</a>
	1	142	87,5	38	1		brake fluid	<a href="#">106TA2842</a>
	1	148	87	40	1		mineral oil	<a href="#">104TA4369</a>
	1	148	87	40	1		mineral oil	<a href="#">104TA4370</a>
	1	149	87	39	1		mineral oil	<a href="#">123TA1445</a>
	1 1/8	159	87,5	40	1		brake fluid	<a href="#">106TA2754</a>



# MASTER & CLUTCH CYLINDERS

For all our latest catalogue updates and company info: [www.tvh.com](http://www.tvh.com)

used for: **CLARK-SAMSUNG**

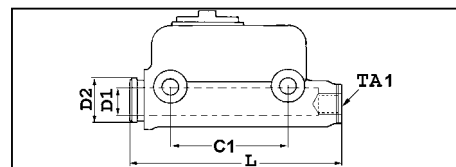

MASTER & CLUTCH CYLINDERS

type of flange TY-FL	piston diameter (inch) D1	dimension (mm) L	dimension (mm) C1	dimension (mm) D2	quantity of outlets for oil AT-PR	thread outlet TA1	type of oil OLIE	reference
no flange	1 1/8	180	87	44	1		brake fluid	<a href="#">104TA4403</a>
	1 1/8	180,5	87	44	1		brake fluid	<a href="#">123TA1447</a>
	1 1/4	163	105	45	1		brake fluid	<a href="#">104TA4459</a>
	1 1/4	176	87,5	44	1		mineral oil	<a href="#">123TA1448</a>
	1 1/4	182	73	44	1		brake fluid	<a href="#">106TA2751</a>
	1 3/8	195	87	43	1		brake fluid	<a href="#">124TA7927</a>
	1 3/4	183	73	49	1		brake fluid	<a href="#">104TA4423</a>
	1 3/4	243	92,5	65	3		brake fluid	<a href="#">106TA2791</a>
oval	5/8	123	57	35	1		brake fluid	<a href="#">123TA1450</a>
	11/16	140	60	42	4		brake fluid	<a href="#">123TA1451</a>
	11/16	143	60	35	3		brake fluid	<a href="#">106TA3160</a>
	3/4	129	57	35,5	1		brake fluid	<a href="#">123TA1452</a>

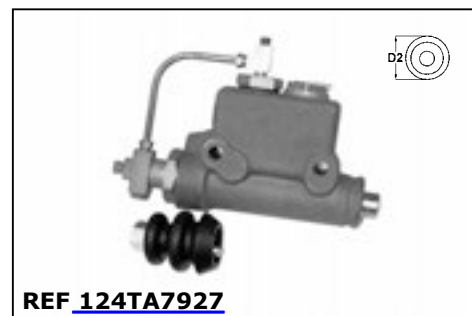
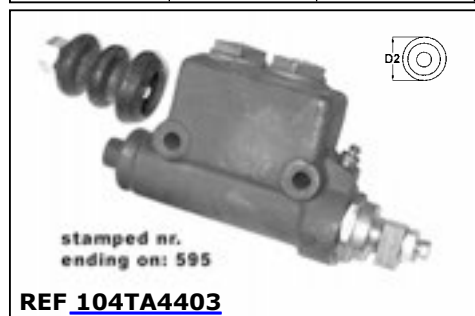

# MASTER & CLUTCH CYLINDERS

For all our latest catalogue updates and company info: [www.tvh.com](http://www.tvh.com)



used for: **CLARK-SAMSUNG**

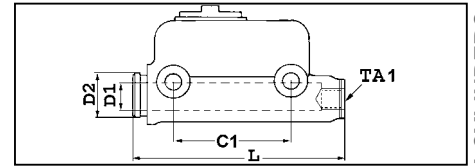

MASTER & CLUTCH CYLINDERS

type of flange TY-FL	piston diameter (inch) D1	dimension (mm) L	dimension (mm) C1	dimension (mm) D2	quantity of outlets for oil AT-PR	thread outlet TA1	type of oil OLIE	reference
oval	3/4	137	60	42	1		brake fluid	<a href="#">106TA3073</a>
	3/4	150	57	35	1		brake fluid	<a href="#">104TA4273</a>
	3/4	150	57	35	1		brake fluid	<a href="#">104TA4274</a>
	20 mm	143	60	35	1		brake fluid	<a href="#">123TA1453</a>
	13/16	125,5	68,5	35	1		brake fluid	<a href="#">104TA4293</a>
	13/16	131	60	42	1		mineral oil	<a href="#">104TA4292</a>
	13/16	134	60	42	1		brake fluid	<a href="#">123TA1455</a>
	13/16	143	60	35	1		brake fluid	<a href="#">123TA1454</a>
	7/8	135	57	35	1	7/16 UNF	brake fluid	<a href="#">104TA4344</a>
	7/8	136	57	35	1		brake fluid	<a href="#">104TA4319</a>
	7/8	136	57	35	1		brake fluid	<a href="#">104TA4318</a>
	7/8	144	60	38	3		brake fluid	<a href="#">123TA1456</a>



# MASTER & CLUTCH CYLINDERS

For all our latest catalogue updates and company info: [www.tvh.com](http://www.tvh.com)

used for: **CLARK-SAMSUNG**

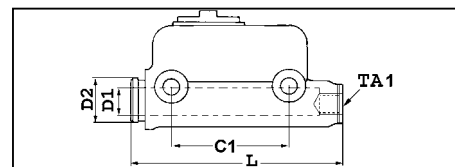

MASTER & CLUTCH CYLINDERS

type of flange TY-FL	piston diameter (inch) D1	dimension (mm) L	dimension (mm) C1	dimension (mm) D2	quantity of outlets for oil AT-PR	thread outlet TA1	type of oil OLIE	reference
oval	7/8	151	70	37	1	3/8 UNF	brake fluid	<a href="#">123TA1458</a>
	7/8	151	70	37	1	3/8 UNF	brake fluid	<a href="#">106TA2905</a>
	7/8	201	81	40	2		brake fluid	<a href="#">123TA1459</a>
	1	126	68	35	2		brake fluid	<a href="#">123TA1460</a>
	1	140	64	40	1		brake fluid	<a href="#">104TA4360</a>
	1 1/8	126	68	35	1		brake fluid	<a href="#">104TA4397</a>
	1 1/8	184	60	40	1		brake fluid	<a href="#">123TA1462</a>
	1 1/8	185	60	40	1		brake fluid	<a href="#">123TA1461</a>
	1 1/8	205	86,5	40,5	2		brake fluid	<a href="#">123TA1464</a>
	1 1/8	222,5	60	42	1		brake fluid	<a href="#">123TA1463</a>
	1 1/4	128	68	37,6	1		brake fluid	<a href="#">104TA4406</a>
	1 5/16	228	86	40	2		brake fluid	<a href="#">123TA1465</a>

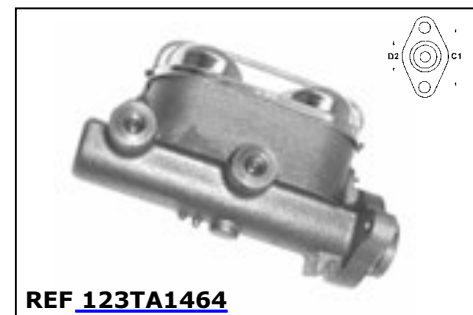



# MASTER & CLUTCH CYLINDERS

For all our latest catalogue updates and company info: [www.tvh.com](http://www.tvh.com)



used for: **CLARK-SAMSUNG**

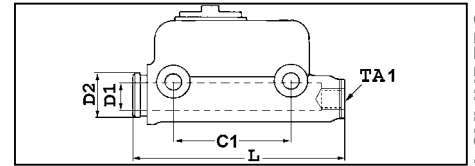

MASTER & CLUTCH CYLINDERS

type of flange TY-FL	piston diameter (inch) D1	dimension (mm) L	dimension (mm) C1	dimension (mm) D2	quantity of outlets for oil AT-PR	thread outlet TA1	type of oil OLIE	reference
rectangular	1 1/4	118	38,5	60	1		brake fluid	<a href="#">123TA1471</a>
	1 3/4	175	61	57	3		brake fluid	<a href="#">106TA2716</a>
triangular	1	146	59	51	1		brake fluid	<a href="#">123TA1466</a>
	1	146	59	51	1		brake fluid	<a href="#">104TA4367</a>
	1	161	60	38	1		brake fluid	<a href="#">106TA2875</a>
	1	161	60	38	1		brake fluid	<a href="#">106TA3199</a>
	1	167	60	37	1		brake fluid	<a href="#">123TA1467</a>
	1	168	58,5	51	3		brake fluid	<a href="#">104TA4383</a>
	1 1/8	159	61	40	1		brake fluid	<a href="#">104TA4449</a>
	1 1/8	159	61	40	1		brake fluid	<a href="#">123TA1468</a>
	1 1/4	158	71,5	63	2		brake fluid	<a href="#">104TA4412</a>
	1 1/4	161	72	63,5	1		brake fluid	<a href="#">123TA1469</a>

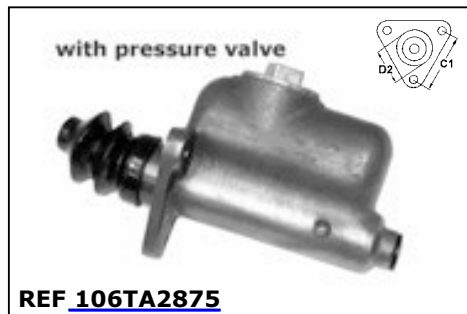
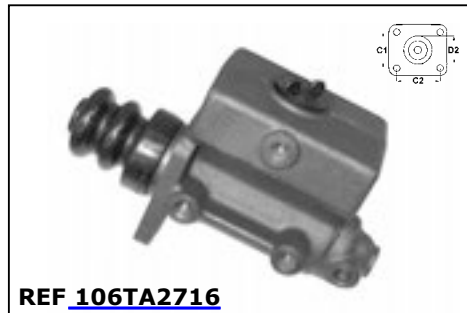



# MASTER & CLUTCH CYLINDERS

For all our latest catalogue updates and company info: [www.tvh.com](http://www.tvh.com)

used for: **CLARK-SAMSUNG**

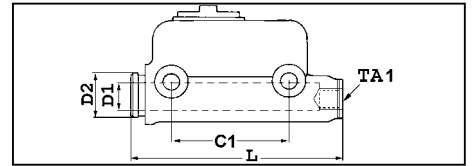

MASTER & CLUTCH CYLINDERS

type of flange TY-FL	piston diameter (inch) D1	dimension (mm) L	dimension (mm) C1	dimension (mm) D2	quantity of outlets for oil AT-PR	thread outlet TA1	type of oil OLIE	reference
triangular	1 1/4	163	72	63	1		brake fluid	<a href="#">104TA4415</a>
	1 1/4	243	60	49	1		brake fluid	<a href="#">104TA4430</a>
	1 1/2	158	72	63,5	1		brake fluid	<a href="#">123TA1470</a>
	1 1/2	161	71	38	1		brake fluid	<a href="#">106TA2773</a>
	1 1/2	161	60,5	38	1		brake fluid	<a href="#">104TA4401</a>
	1 1/2	162	72	63,5	2		brake fluid	<a href="#">123TA9428</a>
	1 1/4	184	70	49	1		brake fluid	<a href="#">104TA4426</a>
	1 3/4	184	71	49	1		brake fluid	<a href="#">104TA4425</a>
	1 3/4	184	71,5	63	1		mineral oil	<a href="#">104TA4424</a>

