

MUFFLERS

For all our latest catalogue updates and company info: www.tvh.com



MUFFLERS

used for: **CLARK-SAMSUNG**

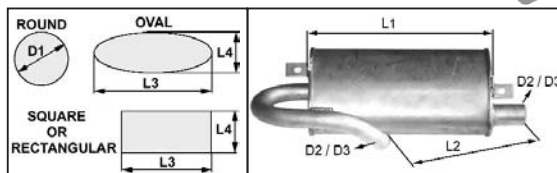

Type muffer	Length (mm) L1	Dimension (mm) L2	Body dimension (mm) dia. D1 or L3 x L4	Smallest outer dia. tube (mm) D2	Largest outer dia. tube (mm) D3	REF
Oval	250	150	230 X 160	48	53	104TA5790
Oval	255	147	227 X 152	48	50	105TA6850
Oval	310	440	230 X 160	48	52	104TA5799
Oval	310	450	230 X 165	48	52	104TA5888
Oval	330	250	230 X 125	42	45	134TA7839
Oval	335	310	225 X 125	42	46	134TA7856
Oval	340	775	270 X 180	42	44	134TA7993
Oval	360	325	275 X 140	51	51	124TA7571
Oval	380	218	200 X 105	32	45	134TA7650
Oval	415	440	200 X 127	60	62	139TA1486
Oval	450	440	190 X 130	48	53	104TA5849
Oval	452	460	224 X 142	51	51	118TA1302





MUFFLERS

For all our latest catalogue updates and company info: www.tvh.com

MUFFLERS

used for: **CLARK-SAMSUNG**

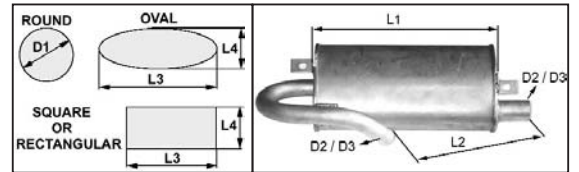

Type muffler	Length (mm) L1	Dimension (mm) L2	Body dimension (mm) dia. D1 or L3 x L4	Smallest outer dia. tube (mm) D2	Largest outer dia. tube (mm) D3	REF
Oval	475	220	205 X 120	45	54	134TA7880
Oval	505	475	237 X 174	65	65	118TA1285
Oval	505	500	237 X 174	65	65	118TA1279
Oval	510	80	210 X 120	50	55	139TA4577
Oval	530	600	205 X 130	51	51	118TA1289
Oval	558	95	255 X 111	54	54	118TA1307
Oval	625	1035	125 X 78	47	53	134TA7786
Oval	630	830	135 X 93	43	50	124TA7573
Oval	680	465	255 X 155	75	81	118TA1306
Oval	740	700	215 X 105	63	63	134TA8013
Round	165	210	116	63	67	134TA8112
Round	280	345	100	41	42	105TA6710

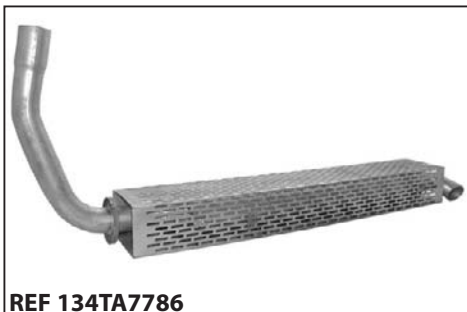
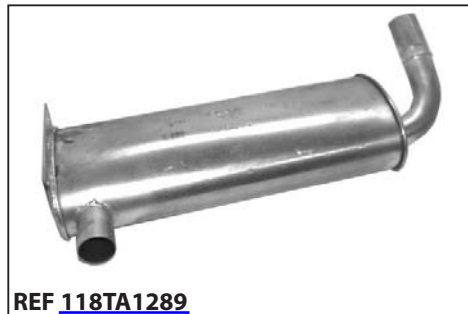

MUFFLERS



For all our latest catalogue updates and company info: www.tvh.com

used for: **CLARK-SAMSUNG**

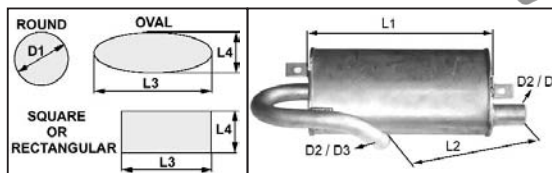

MUFFLERS

Type muffler	Length (mm)	Dimension (mm)	Body dimension (mm)	Smallest outer dia. tube (mm)	Largest outer dia. tube (mm)	REF
TY	L1	L2	dia. D1 or L3 x L4	D2	D3	
Round	292	460	163	50	50	110TA8568
Round	295	755	135	39	47	139TA1487
Round	300	280	155	48	49	104TA5806
Round	305	200	150	41	48	104TA5965
Round	305	270	155	41	48	105TA6725
Round	310	270	100	40	40	134TA7588
Round	312	128	127	35	40	134TA7917
Round	312	280	110	43	43	139TA1488
Round	330	240	115	51	57	134TA8104
Round	330	345	144	35	36	105TA6654
Round	330	360	160	51	55	104TA5857
Round	345	410	155	38	50	134TA7929

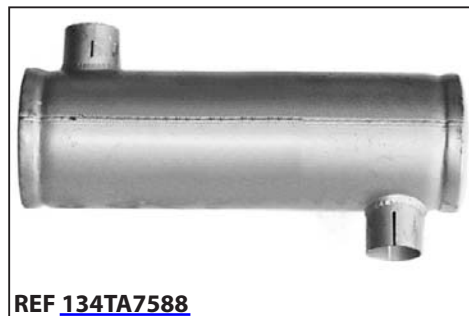



MUFFLERS

For all our latest catalogue updates and company info: www.tvh.com

MUFFLERS

used for: **CLARK-SAMSUNG**

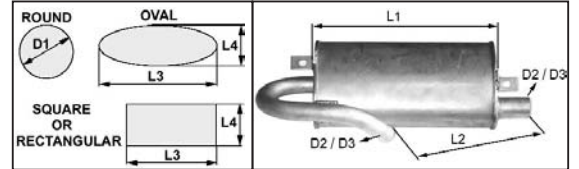

Type muffler	Length (mm) L1	Dimension (mm) L2	Body dimension (mm) dia. D1 or L3 x L4	Smallest outer dia. tube (mm) D2	Largest outer dia. tube (mm) D3	REF
Round	350	285	127	49	49	134TA7811
Round	360	300	140	43	43	104TA5750
Round	365	290	200	55	55	139TA1489
Round	370	260	125	41	41	134TA8117
Round	380	250	130	35	35	123TA6017
Round	380	310	165	52	55	104TA5749
Round	380	370	155	54	54	104TA5764
Round	380	525	121	60	63	124TA7183
Round	390	265	120	38	39	134TA7643
Round	390	510	150	79	79	134TA8130
Round	390	540	170	80	81	104TA5827
Round	395	305	154	60	67	106TA5007

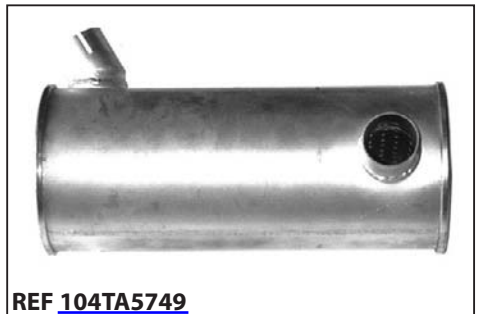

MUFFLERS

For all our latest catalogue updates and company info: www.tvh.com



MUFFLERS

used for: **CLARK-SAMSUNG**

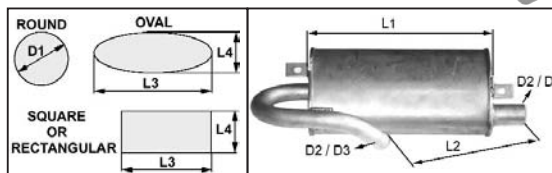

Type muffler	Length (mm) L1	Dimension (mm) L2	Body dimension (mm) dia. D1 or L3 x L4	Smallest outer dia. tube (mm) D2	Largest outer dia. tube (mm) D3	REF
Round	397	335	150	49	55	108TA4368
Round	407	23	143	41	49	134TA7713
Round	410	350	125	42	42	134TA8040
Round	410	500	145	44	49	134TA7630
Round	415	380	126	43	44	118TA1265
Round	415	522	156	64	68	134TA8116
Round	420	270	130	40	41	104TA5778
Round	420	293	149	48	50	118TA1272
Round	420	330	127	42	42	118TA1287
Round	421	320	120	40	40	134TA7676
Round	430	0	125	55	0	118TA1273
Round	435	140	129	0	55	139TA4578

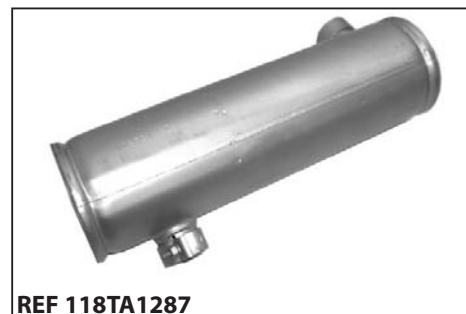
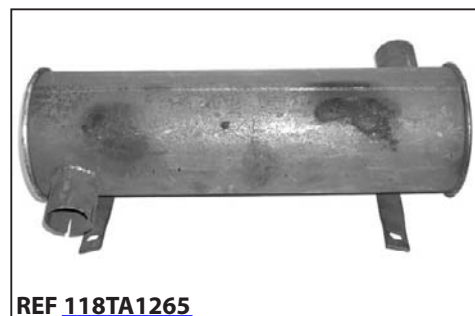



MUFFLERS

For all our latest catalogue updates and company info: www.tvh.com

MUFFLERS

used for: **CLARK-SAMSUNG**

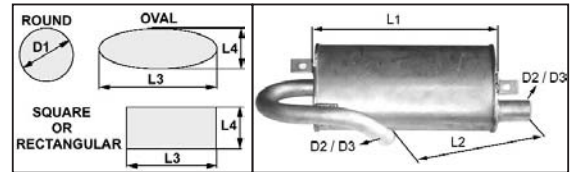

Type muffler	Length (mm) L1	Dimension (mm) L2	Body dimension (mm) dia. D1 or L3 x L4	Smallest outer dia. tube (mm) D2	Largest outer dia. tube (mm) D3	REF
Round	445	290	125	40	44	123TA6018
Round	470	480	200	48	50	123TA6021
Round	470	705	197	48	50	118TA1241
Round	475	460	155	51	62	124TA7570
Round	485	213	101	47	54	118TA1334
Round	492	245	161	41	48	118TA1362
Round	495	470	100	45	45	118TA1296
Round	500	215	127	42	42	118TA1304
Round	500	250	169	41	41	118TA1340
Round	500	260	167	42	43	123TA6025
Round	500	260	170	42	42	124TA1981
Round	500	360	168	43	48	118TA1350

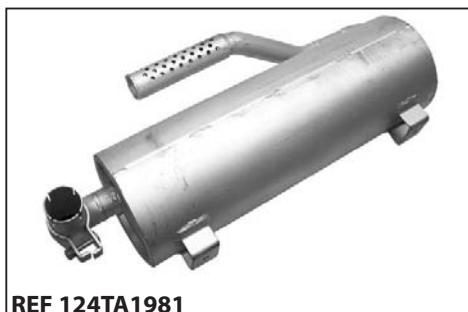
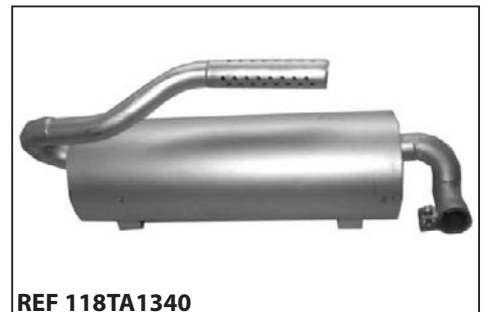

MUFFLERS



For all our latest catalogue updates and company info: www.tvh.com

used for: **CLARK-SAMSUNG**

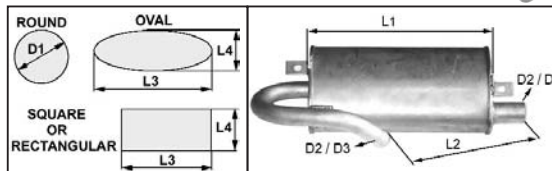

MUFFLERS

Type muffler TY	Length (mm) L1	Dimension (mm) L2	Body dimension (mm) dia. D1 or L3 x L4	Smallest outer dia. tube (mm) D2	Largest outer dia. tube (mm) D3	REF
Round	500	360	170	44	55	134TA7846
Round	500	450	150	51	63	104TA5830
Round	500	480	110	45	45	104TA5761
Round	505	235	170	42	42	134TA7914
Round	505	270	165	42	42	134TA7943
Round	505	370	165	44	55	123TA6020
Round	509	17	168	68	68	118TA1315
Round	510	350	130	51	55	104TA5787
Round	510	470	157	42	43	118TA1373
Round	510	620	130	54	54	105TA6733
Round	520	540	120	50	54	104TA5785
Round	525	585	154	50	50	108TA4331





MUFFLERS

For all our latest catalogue updates and company info: www.tvh.com

MUFFLERS

used for: **CLARK-SAMSUNG**

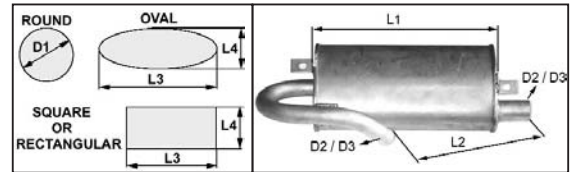

Type muffler	Length (mm) L1	Dimension (mm) L2	Body dimension (mm) dia. D1 or L3 x L4	Smallest outer dia. tube (mm) D2	Largest outer dia. tube (mm) D3	REF
Round	530	400	155	55	56	118TA1242
Round	535	380	220	57	57	124TA2823
Round	545	570	240	69	69	139TA1490
Round	550	425	146	54	54	110TA8545
Round	550	430	130	42	54	104TA5748
Round	550	700	95	47	54	110TA8578
Round	565	570	130	47	52	123TA6022
Round	590	830	180	80	80	105TA6726
Round	600	455	140	54	55	118TA1348
Round	600	620	220	69	69	123TA6023
Round	600	650	220	70	70	134TA7901
Round	600	790	175	52	65	105TA6808

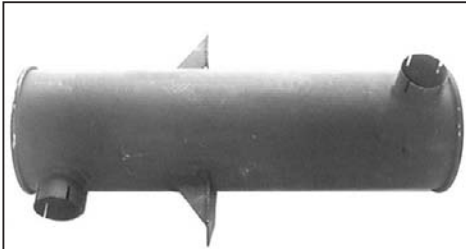

REF [118TA1242](#)

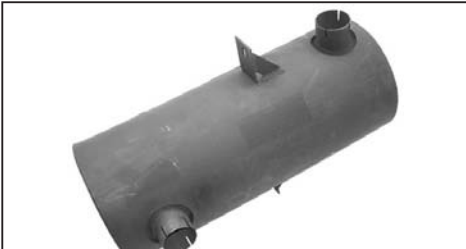

REF [124TA2823](#)



REF [139TA1490](#)



REF [110TA8545](#)



REF [104TA5748](#)



REF [110TA8578](#)



REF [123TA6022](#)



REF [105TA6726](#)

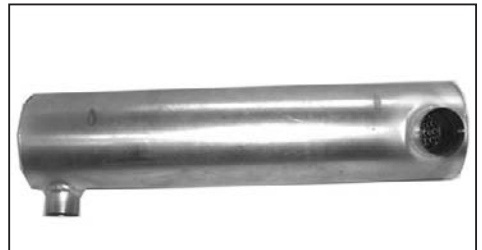

REF [118TA1348](#)



REF [123TA6023](#)



REF [134TA7901](#)

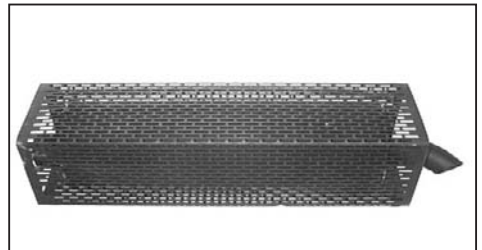

REF [105TA6808](#)

MUFFLERS

For all our latest catalogue updates and company info: www.tvh.com



MUFFLERS

used for: **CLARK-SAMSUNG**

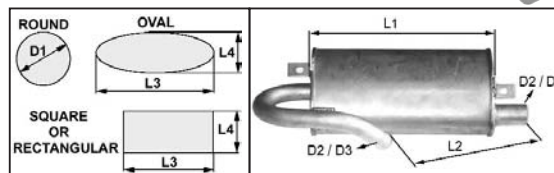

Type muffler	Length (mm) L1	Dimension (mm) L2	Body dimension (mm) dia. D1 or L3 x L4	Smallest outer dia. tube (mm) D2	Largest outer dia. tube (mm) D3	REF
Round	600	1230	150	45	51	134TA8036
Round	600	1570	180	52	63	104TA5987
Round	605	1375	158	60	60	111TA3681
Round	605	1500	160	50	64	134TA7617
Round	610	600	197	69	69	123TA6024
Round	670	350	103	48	42	124TA7564
Round	710	812	214	80	80	110TA8565
Round	710	890	170	67	67	104TA5940
Round	715	940	155	54	75	134TA7797
Round	725	940	110	42	45	134TA7908
Round	735	660	205	62	62	139TA4579
Round	745	575	128	44	48	139TA4580





MUFFLERS

For all our latest catalogue updates and company info: www.tvh.com

MUFFLERS

used for: **CLARK-SAMSUNG**

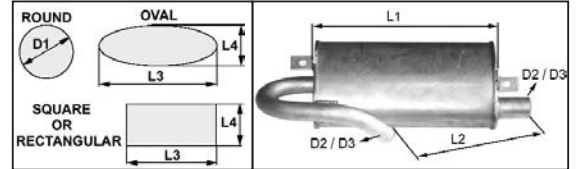

Type muffler TY	Length (mm) L1	Dimension (mm) L2	Body dimension (mm) dia. D1 or L3 x L4	Smallest outer dia. tube (mm) D2	Largest outer dia. tube (mm) D3	REF
Round	745	900	160	67	70	104TA5870
Round	746	620	138	48	48	118TA1286
Round	750	490	107	45	49	134TA7853
Round	750	1210	45	48	53	105TA6728
Round	760	500	110	45	48	134TA7920
Round	760	1030	60	58	58	104TA5971
Round	765	920	215	77	80	139TA4581
Round	770	906	195	64	64	123TA6026
Round	912	740	203	81	92	105TA6828
Round	1068	1224	193	75	93	104TA5986

